

# SP4T Reflective Switch DC - 57 GHz



MASW-011153

Rev. V4

## Features

- Ultra Wideband: 9 kHz to 57 GHz
- Insertion Loss:
  - 1.5 dB @ 18 GHz
  - 2.4 dB @ 40 GHz
  - 3.5 dB @ 57 GHz
- Isolation:
  - 50 dB @ 18 GHz
  - 36 dB @ 40 GHz
  - 34 dB @ 57 GHz
- Input P1dB: 28.5 dBm
- Input IP3: 51 dBm
- Return Loss at Each RF Port: 16 dB
- Power Handling including Hot Switching: 26 dBm
- No Low Frequency Spurious
- Compatible with 1.8, 2.5, and 3.3 V CMOS Logic
- 3 mm, 22 pin Laminate Package
- RoHS\* Compliant

## Applications

- Test & Measurement
- ISM, Multi Market

## Description

The MASW-011153 is a reflective, ultra wideband single pole four throw (SP4T) switch with 3.5 dB of insertion loss at 57 GHz. The power handling capability is 26 dBm. The input and output return losses in the thru path are typically 16 dB. The logic levels are compatible with standard 1.8, 2.5, or 3.3 V CMOS. Required bias supplies are +3.3 V and -3.3 V.

The MASW-011153 is designed for wideband applications such as Test and Measurement, Aerospace and Defense, Cellular infrastructure (5G millimeter-wave), military radios, radars, microwave radios and very small aperture terminals (VSATs).

The MASW-011153 is manufactured on a Silicon-on-Insulator process. The 3 mm laminate package is lead free and RoHS compliant.

## Functional Schematic

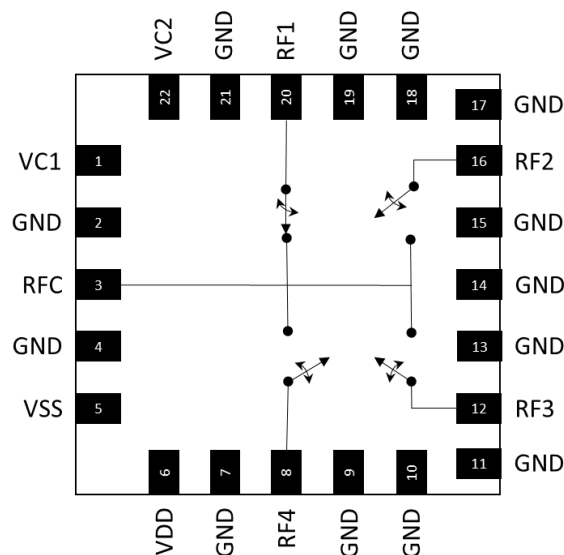

## Pin Configuration<sup>1</sup>

Pin #	Pin Name	Description
1	VC1	Control Voltage 1
2,4,7,9-11, 13-15,17-19,21	GND	Ground
3	RFC <sup>2</sup>	Common RF Input/Output
5	VSS	-3.3 V
6	VDD	+3.3 V
8	RF4 <sup>2</sup>	RF Input/Output 4
12	RF3 <sup>2</sup>	RF Input/Output 3
16	RF2 <sup>2</sup>	RF Input/Output 2
20	RF1 <sup>2</sup>	RF Input/Output 1
22	VC2	Control Voltage 2

1. The exposed pad centered on the package bottom must be connected to RF, dc, and thermal ground.
2. RF ports are dc-coupled to GND. There are no internal dc blocking capacitors.

## Ordering Information<sup>3,4</sup>

Part Number	Package
MASW-011153-TR0500	500 piece reel
MASW-011153-SB1	Sample Board

3. Reference Application Note M513 for reel size information.
4. All sample boards include 3 loose parts.

<sup>1</sup> \* Restrictions on Hazardous Substances, compliant to current RoHS EU directive.

# SP4T Reflective Switch

## DC - 57 GHz



MASW-011153

Rev. V4

### Electrical Specifications<sup>5</sup>:

$V_{DD} = +3.3\text{ V}$ ,  $V_{SS} = -3.3\text{ V}$ ,  $VC1 / VC2 = 0\text{ V or }1.8\text{ V}$ ,  $T_{PADDLE} = 25^{\circ}\text{C}$ ,  $Z_0 = 50\ \Omega$

Parameter	Test Conditions	Units	Min.	Typ.	Max.
Insertion Loss	DC to 18 GHz	dB	—	1.3	—
	18 GHz			1.5	2.2
	30 GHz			1.9	2.6
	44 GHz			2.6	4.0
	57 GHz			3.5	—
Isolation, Between RF1 / RF2 / RF3 / RF4	DC to 18 GHz	dB	—	50	—
	18 GHz			50	—
	30 GHz			42	—
	44 GHz			35	—
	57 GHz			34	—
Isolation, RFC to RF1 / RF2 / RF3 / RF4	DC to 18 GHz	dB	—	52	—
	18 GHz		42	50	—
	30 GHz		38	46	—
	44 GHz		—	43	—
	57 GHz		—	37	—
RFC Return Loss	DC - 57 GHz	dB	—	16	—
RF1/RF2/RF3/RF4 Return Loss, Thru Port	DC - 57 GHz	dB	—	16	—
Input P0.1dB	10 MHz - 57 GHz	dBm	—	27.5	—
Input P1dB	10 MHz - 57 GHz	dBm	—	28.5	—
Input IP3	Two tone, $P_{IN}/\text{tone} = +14\text{ dBm}$ 10 MHz - 57 GHz	dBm	—	51	—
$T_{ON}$	50% control to 90% RF	$\mu\text{s}$	—	0.90	—
$T_{RISE}$	10% to 90% RF	$\mu\text{s}$	—	0.36	—
$T_{OFF}$	50% control to 10% RF	$\mu\text{s}$	—	0.17	—
$T_{FALL}$	90% to 10% RF	$\mu\text{s}$	—	0.04	—
Voltage Supply, VDD	—	V	+3.15	+3.3	+3.45
Voltage Supply, VSS	—	V	-3.45	-3.3	-3.15
Logic Voltage, Input Low ( $V_{IL}$ )	—	V	0.0	—	+0.8
Logic Voltage, Input High ( $V_{IH}$ )	—	V	+1.2	—	VDD
Supply Current, VDD	—	mA	—	0.3	0.5
Supply Current, VSS	—	mA	—	0.66	1.0
Logic Pin Current (VC1 / VC2)	Pulled down to GND with 100 k $\Omega$ resistor	$\mu\text{A}$	—	VC*10	—

5. Parameters are measured on a test board that includes impedance matching. Device shall be aligned to recommended PCB footprint +/- 1 mil for optimum performance

**Maximum Operating Conditions**

Parameter	Maximum
Input Power, 300 MHz to 40 GHz, RFC Port <sup>6</sup> RF1 / RF2 / RF3 / RF4 Port <sup>6</sup>	26 dBm 26 dBm
VDD	-0.3 to +3.45 V
VSS	-3.45 to +0.3 V
VC1 / VC2	-0.3 to 3.45 V
Operating Temperature <sup>7</sup>	-40 to +105°C

6. T<sub>PADDLE</sub> = 105 °C. See power derating curves for details.

7. Guarantees 10 years lifetime.

**Power Derating Curve<sup>6</sup>**

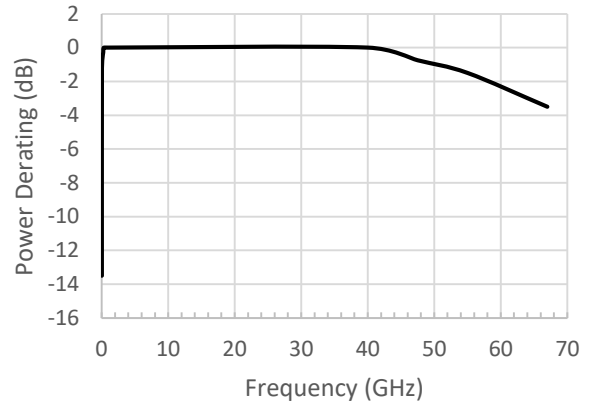

**Absolute Maximum Ratings<sup>8,9,10</sup>**

Parameter	Absolute Maximum
Input Power, 300 MHz to 40 GHz, RFC Port <sup>6</sup> RF1 / RF2 / RF3 / RF4 Port <sup>6</sup>	27 dBm 27 dBm
VDD	-0.3 to +3.6 V
VSS	-3.6 to +0.3 V
VC1 / VC2	-0.3 to 3.6 V
Junction Temperature	+135°C

8. Exceeding any one or combination of these limits may cause permanent damage to this device.

9. MACOM does not recommend sustained operation near these survivability limits.

10. Based on testing with input power applied for 30 seconds.

**Low Frequency Power Derating Detail<sup>6</sup>**

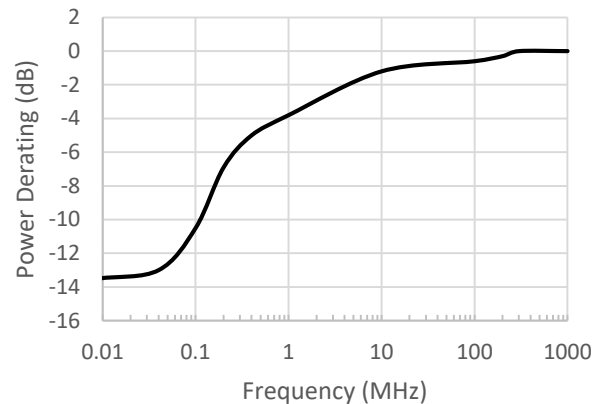

**Truth Table**

Control 1	Control 2	Condition of Switch			
		RF1	RF2	RF3	RF4
VC1	VC2	RF1	RF2	RF3	RF4
V <sub>IL</sub>	V <sub>IL</sub>	On	Off	Off	Off
V <sub>IH</sub>	V <sub>IL</sub>	Off	On	Off	Off
V <sub>IL</sub>	V <sub>IH</sub>	Off	Off	On	Off
V <sub>IH</sub>	V <sub>IH</sub>	Off	Off	Off	On

**Handling Procedures**

Please observe the following precautions to avoid damage:

**Static Sensitivity**

These electronic devices are sensitive to electrostatic discharge (ESD) and can be damaged by static electricity. Proper ESD control techniques should be used when handling these devices.

Parameter	Rating	Standard
Human Body Model (HBM)	Class 1C	ESDA/JEDEC JS-001
Charged Device Model (CDM)	Class C3	ESDA/JEDEC JS-002

### Application Schematic

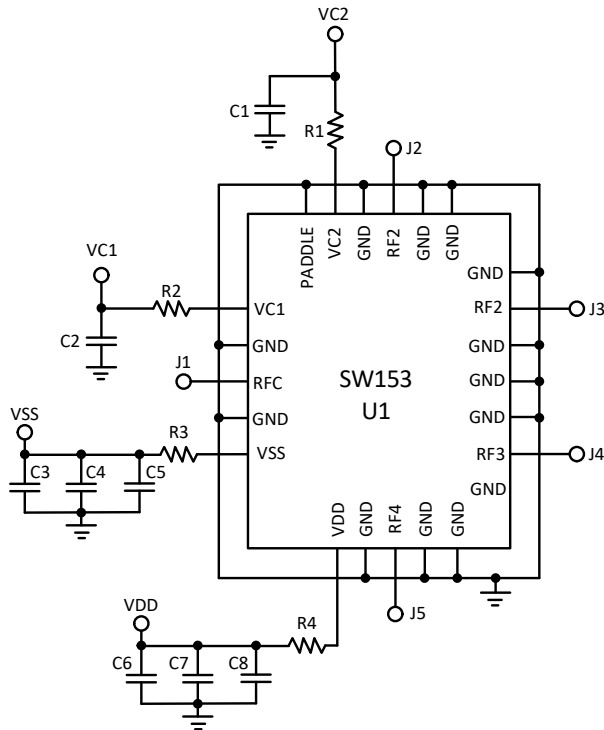

### Impedance Match

MASW-011153-SB1 is a 2-layer board with 8 mil Rogers RO4003 dielectric material and 1 oz. copper on top and bottom layers. For this stack-up, 5 mil traces with 7 mil width are used for all RF port matching, as shown below.

The 50Ω RF transmission lines are CPWG of 14 mil width with 6.5 mil gap.

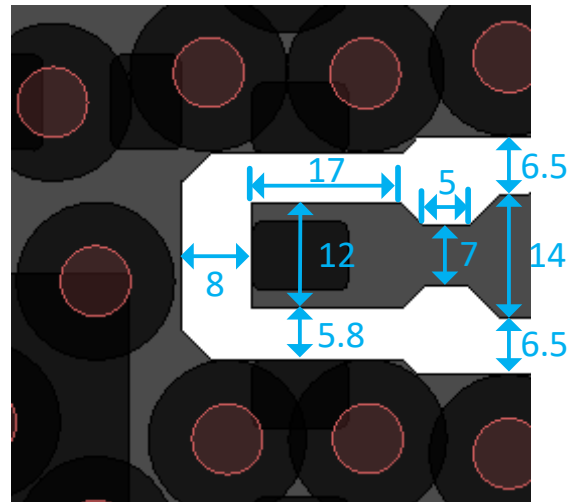

### Parts List

Part	Value	Case Style
U1	MASW-011153	3 mm, 22 Lead
C1, C2	Capacitor, 5 pF, 16 V	0402
C3, C6	Capacitor, 10 pF, 50 V	0402
C4, C7	Capacitor, 1000 pF, 25 V	0402
C5, C8	Capacitor, 1 μF, 10 V	0402
R1 - R4	Resistor, 0 Ω	0402
J1 - J5	Southwest 1892-04A-6	End Launch

### Evaluation Board Layout

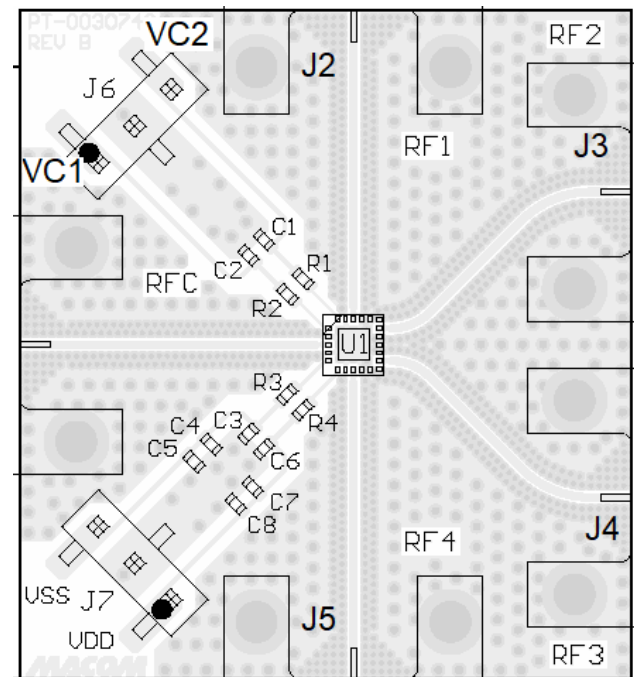

**Typical Performance Curves**

**Insertion Loss<sup>11</sup>**

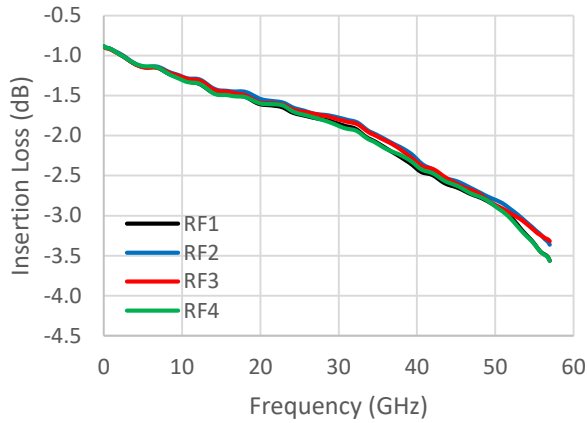

**RFC to RF1/RF4 Insertion Loss over Temperature<sup>11</sup>**

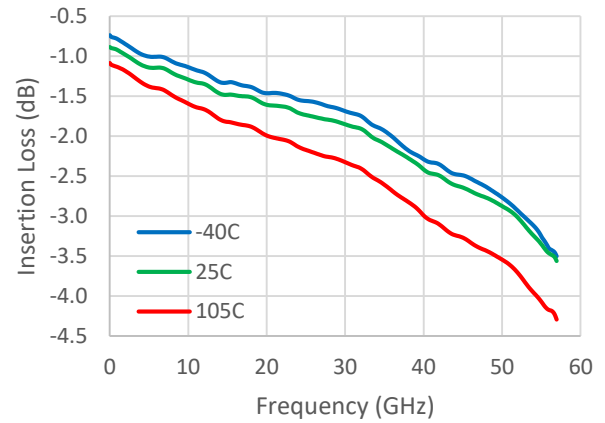

**RFC Return Loss<sup>12</sup>**

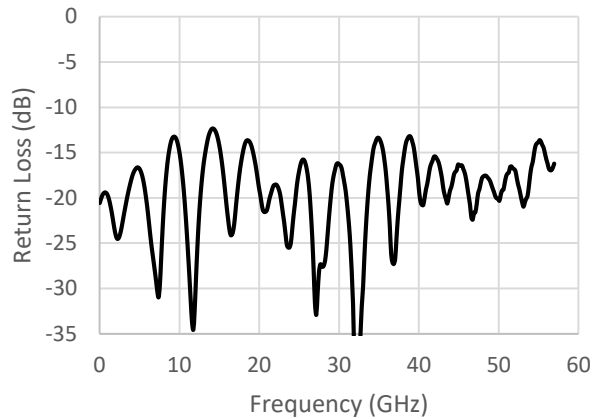

**RF1/RF2/RF3/RF4 Return Loss<sup>12</sup>**

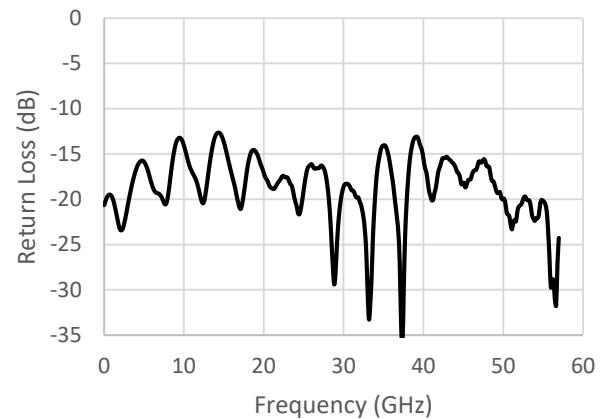

**Evaluation Board Thru Line Insertion Loss**

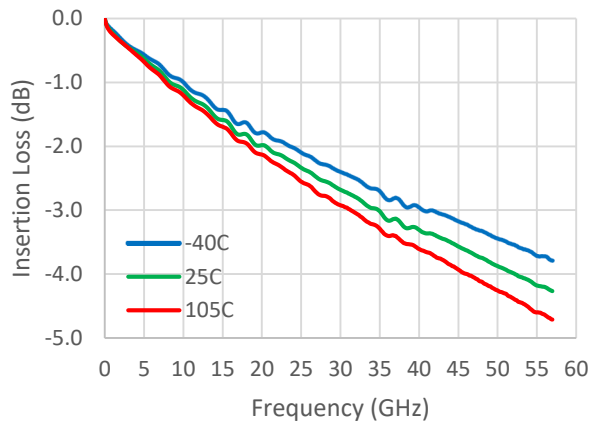

**Evaluation Board Thru Line Return Loss**

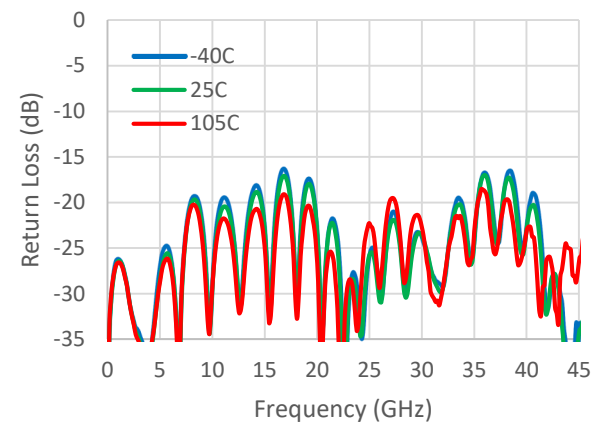

11. Insertion Loss and Isolation were measured using connectorized evaluation board with impedance match on RF transmission lines, and normalized using the insertion loss of the 50Ω thru line.

5 12. Return Loss with impedance match were measured using connectorized evaluation board with impedance match on RF transmission lines.

MACOM Technology Solutions Inc. (MACOM) and its affiliates reserve the right to make changes to the product(s) or information contained herein without notice. Visit [www.macom.com](http://www.macom.com) for additional data sheets and product information.

### Typical Performance Curves

**RFC to RF2 / RF3 / RF4 Isolation, RFC to RF1 On<sup>11</sup>**

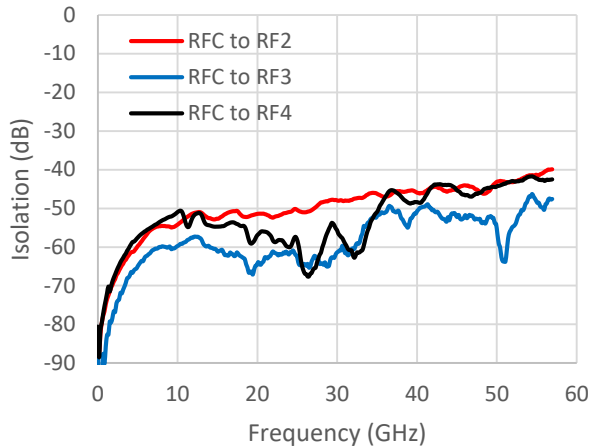

**RFC to RF1 / RF2 / RF3 Isolation, RFC to RF4 On<sup>11</sup>**

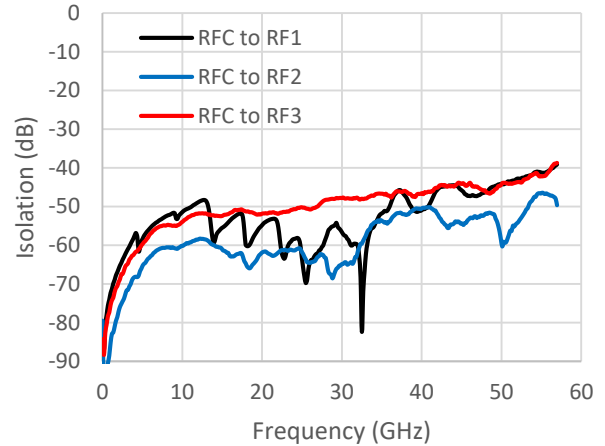

**RFC to RF1 / RF3 / RF4 Isolation, RFC to RF2 On<sup>11</sup>**

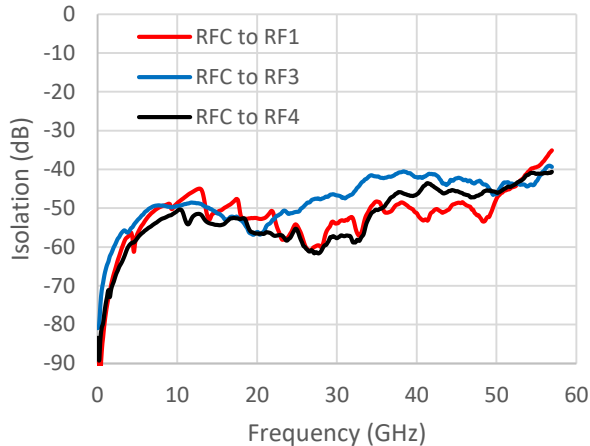

**RFC to RF1 / RF2 / RF4 Isolation, RFC to RF3 On<sup>11</sup>**

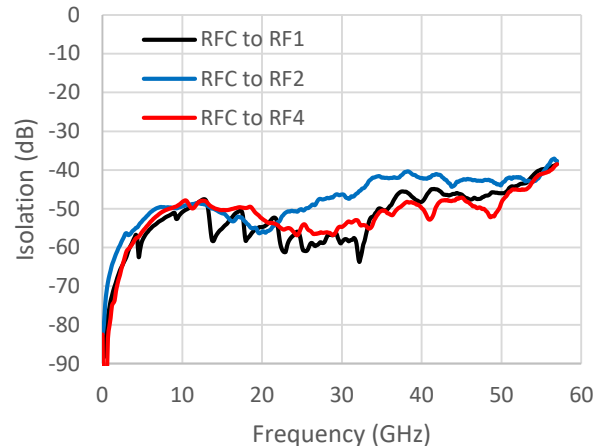

**Isolation between RF1 to RF4, RFC to RF1 On<sup>11</sup>**

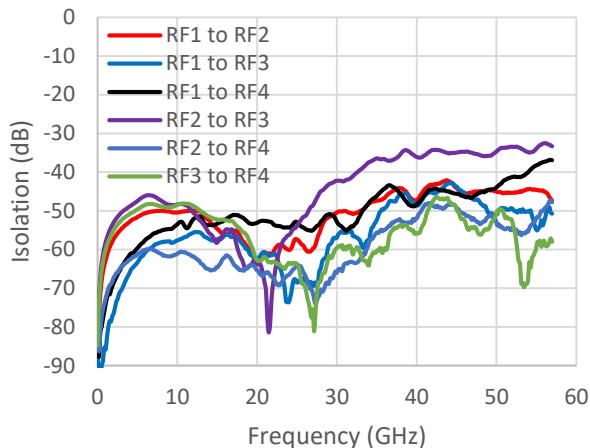

**Isolation between RF1 to RF4, RFC to RF4 On<sup>11</sup>**

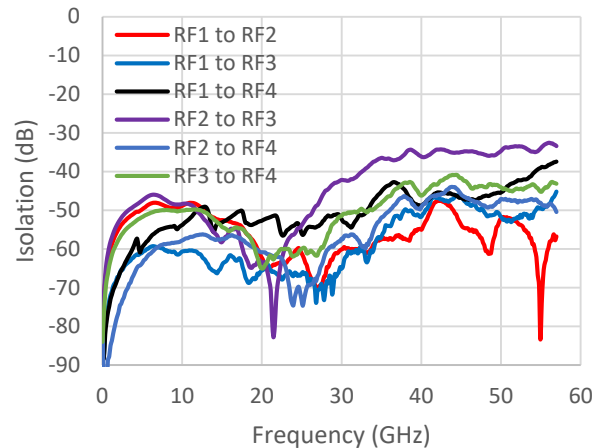

## Typical Performance Curves

**Isolation between RF1 to RF4, RFC to RF2 On<sup>11</sup>**

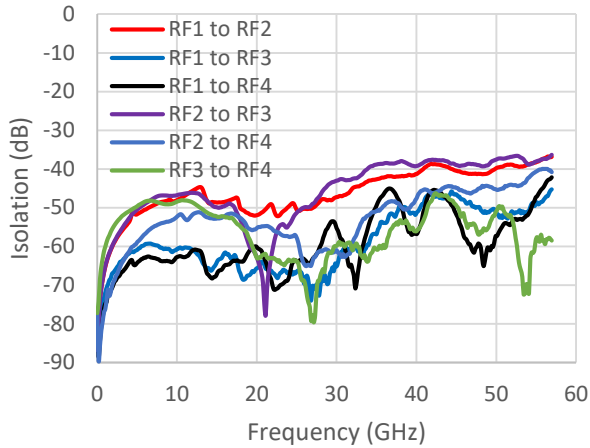

**Isolation between RF1 to RF4, RFC to RF3 On<sup>11</sup>**

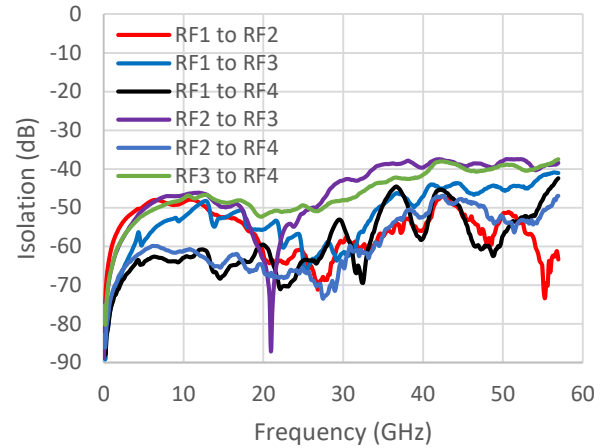

**Input P0.1dB**

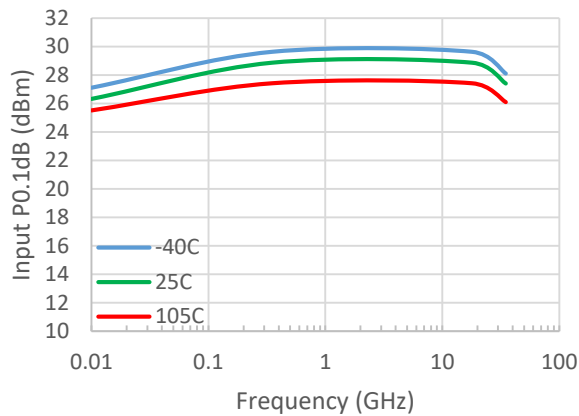

**Input P1dB**

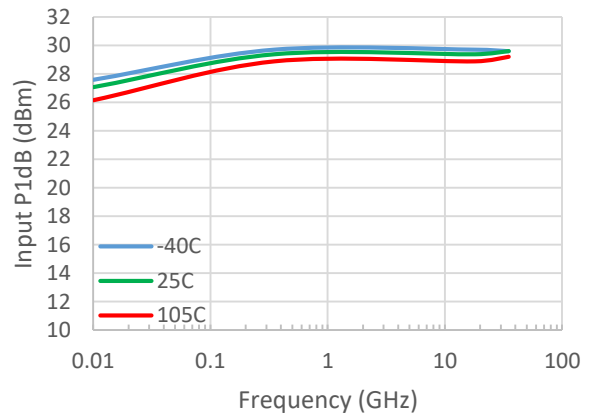

**Input IP3<sup>13</sup>**

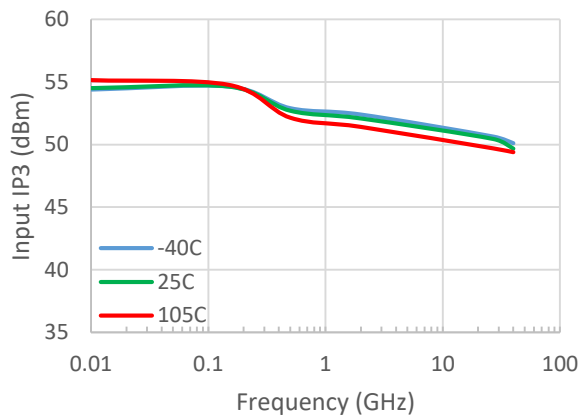

13. Input IP3 were measured using connectorized evaluation board with impedance matching. The RF input power was 14 dBm per tone with spacing of 1 MHz.

**Lead Free 3 mm 22-Lead Laminate Package †**

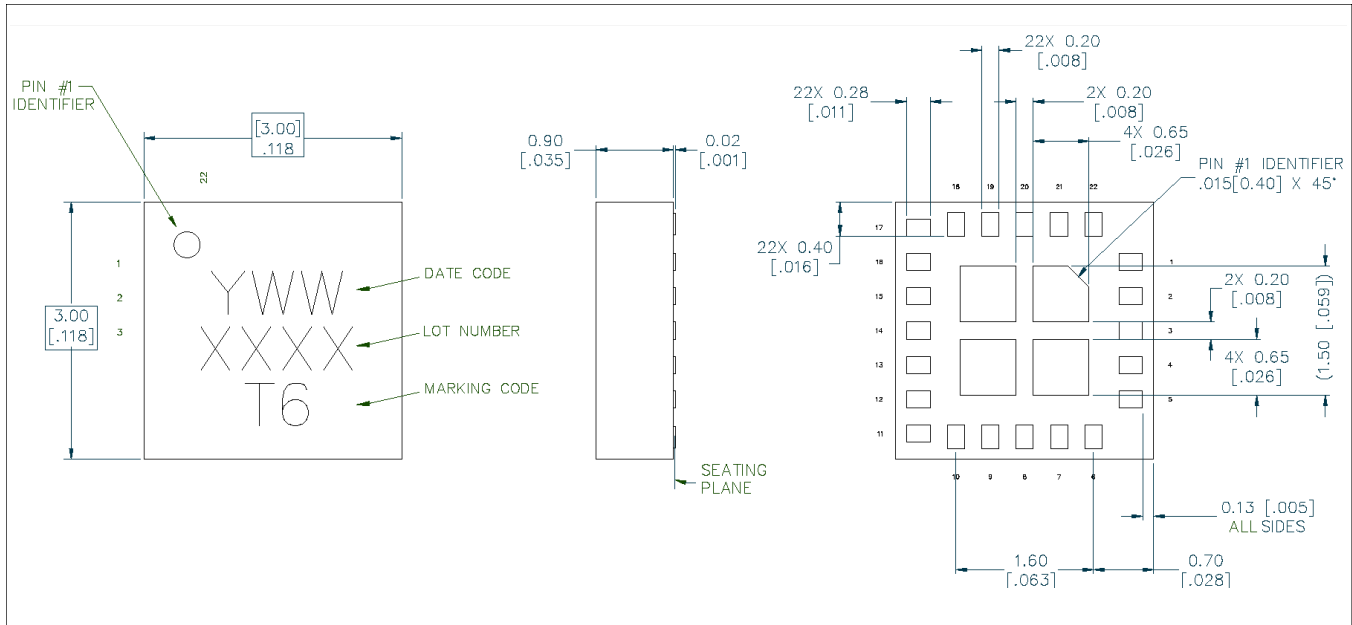

† Reference Application Note S2083 for lead-free solder reflow recommendations.  
Meets JEDEC moisture sensitivity level 3 requirements.  
Plating is 100% matte tin over copper.



MACOM Technology Solutions Inc. ("MACOM"). All rights reserved.

These materials are provided in connection with MACOM's products as a service to its customers and may be used for informational purposes only. Except as provided in its Terms and Conditions of Sale or any separate agreement, MACOM assumes no liability or responsibility whatsoever, including for (i) errors or omissions in these materials; (ii) failure to update these materials; or (iii) conflicts or incompatibilities arising from future changes to specifications and product descriptions, which MACOM may make at any time, without notice. These materials grant no license, express or implied, to any intellectual property rights.

THESE MATERIALS ARE PROVIDED "AS IS" WITH NO WARRANTY OR LIABILITY, EXPRESS OR IMPLIED, RELATING TO SALE AND/OR USE OF MACOM PRODUCTS INCLUDING FITNESS FOR A PARTICULAR PURPOSE, MERCHANTABILITY, INFRINGEMENT OF INTELLECTUAL PROPERTY RIGHT, ACCURACY OR COMPLETENESS, OR SPECIAL, INDIRECT, INCIDENTAL, OR CONSEQUENTIAL DAMAGES WHICH MAY RESULT FROM USE OF THESE MATERIALS.

MACOM products are not intended for use in medical, lifesaving or life sustaining applications. MACOM customers using or selling MACOM products for use in such applications do so at their own risk and agree to fully indemnify MACOM for any damages resulting from such improper use or sale.