

C-Band PIN Diode Limiter

4 - 8 GHz



MADL-011074-DIE

Rev. V1

Features

- Insertion Loss: <0.6 dB
- Return Loss: >15 dB
- Handles 40 dBm CW Power
- Low Flat Leakage Power: <19 dBm
- Die Size: 2.78 x 2.20 mm
- RoHS* Compliant
- Passive Device

Applications

- ISM
- Multi Market
- Radar
- EW

Description

The MADL-011074-DIE is an integrated AlGaAs PIN Diode limiter. It is a passive device, DC de-coupled at both the input and output ports.

The limiter is ideally designed to provide low insertion loss, at zero bias, as well as low flat leakage power with fast signal response/recovery times. It can limit up to 40 dBm incident CW power at room temperature. It is available in die form with a compact die dimension of 2.78 x 2.20 mm.

The MADL-011074 PIN limiter is designed for use in passive limiter control circuits to protect sensitive receiver components such as low noise amplifiers (LNA), detectors, and mixers.

Functional Schematic

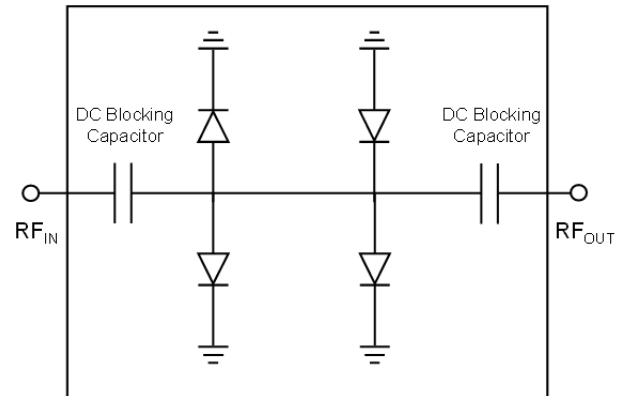

Pin Configuration

Pin #	Pin Name	Description
1	RF _{IN}	RF Input
2	RF _{OUT}	RF Output
3 - 6	GND	Ground

Ordering Information

Part Number	Package
MADL-011074-DIE	Die in Gel Pack

* Restrictions on Hazardous Substances, compliant to current RoHS EU directive.

Electrical Specifications: $T_A = 25^\circ\text{C}$, $Z_0 = 50 \Omega$

Parameter	Test Conditions	Units	Min.	Typ.	Max.
Insertion Loss	$P_{IN} = -10 \text{ dBm}$ 4 GHz 8 GHz	dB	—	0.6	0.8 0.9
Input Return Loss	$P_{IN} = -10 \text{ dBm}$ 4 - 8 GHz	dB	—	15	—
Output Return Loss	$P_{IN} = -10 \text{ dBm}$ 4 - 8 GHz	dB	—	15	—
Max CW Incident Power	4 - 8 GHz	dBm	—	40	—
CW Flat Leakage	$P_{IN} > 31 \text{ dBm}$ 4 GHz 8 GHz	dBm	—	17 16	19 18
Spike Leakage Power	$P_{IN} = 42 \text{ dBm}$, 100 μs , 1% DC 4 - 8 GHz	dBm	—	24	—
Recovery Time (1 dB Insertion Loss)	$P_{IN} = 42 \text{ dBm}$, 100 μs , 1% DC 4 - 8 GHz	ns	—	130	—
Input IP3	10 MHz Offset, $P_{IN}/\text{tone} = 0 \text{ dBm}$	dBm	—	32	—

Absolute Maximum Ratings^{1,2}

Parameter	Absolute Maximum
Incident CW RF Power at +25°C	40.3 dBm
Peak Incident Power 1 μs pulse, 1% DC at +25°C	43 dBm
Junction Temperature ³	+150°C
Operating Temperature	-40°C to +85°C
Storage Temperature	-55°C to +150°C

1. Exceeding any one or combination of these limits may cause permanent damage to this device.
2. MACOM does not recommend sustained operation near these survivability limits.
3. Operating at nominal conditions with $T_J \leq +150^\circ\text{C}$ will ensure $\text{MTTF} > 1 \times 10^6$ hours.

Handling Procedures

The protective polymer coating on the active areas of the die provides scratch and impact protection, particularly for the metal air bridge, which contacts the diode's anode. Die should primarily be handled with vacuum pickup tools, or alternatively with plastic tweezers.

Static Sensitivity

These electronic devices are sensitive to electrostatic discharge (ESD) and can be damaged by static electricity. Proper ESD control techniques should be used when handling these HBM Class 1B devices.

C-Band PIN Diode Limiter 4 - 8 GHz



MADL-011074-DIE

Rev. V1

Typical Small-Signal Performance, Die On-Wafer: $T_A = 25^\circ\text{C}$, $Z_0 = 50 \Omega$

Insertion Loss

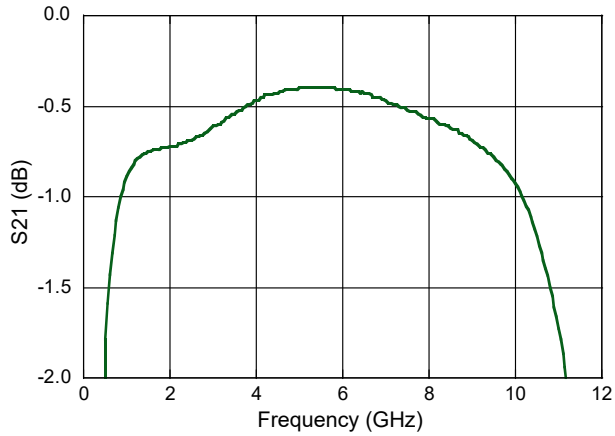

Input Return Loss

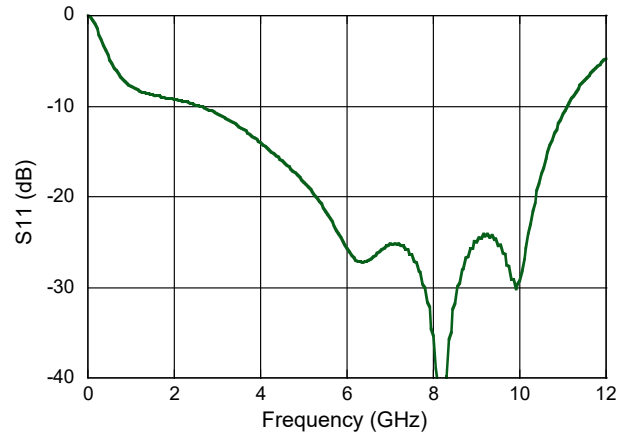

Output Return Loss

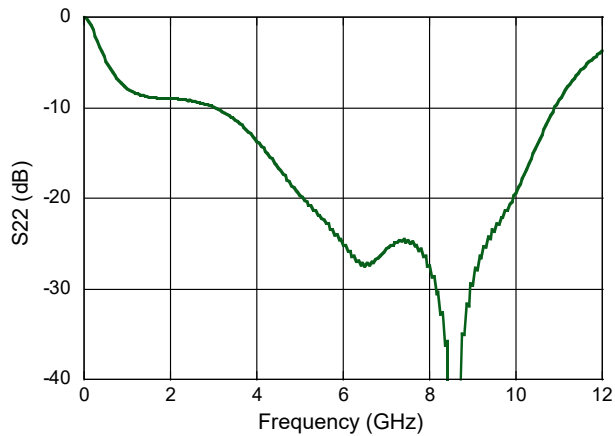

C-Band PIN Diode Limiter 4 - 8 GHz



MADL-011074-DIE

Rev. V1

Typical Small-Signal Performance, Die On-Board: $Z_0 = 50 \Omega$

Insertion Loss

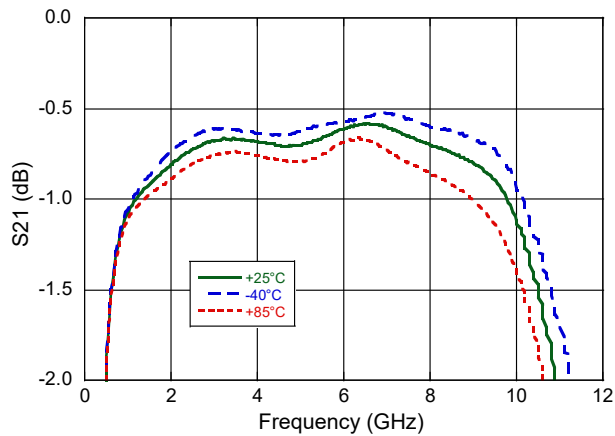

Input Return Loss

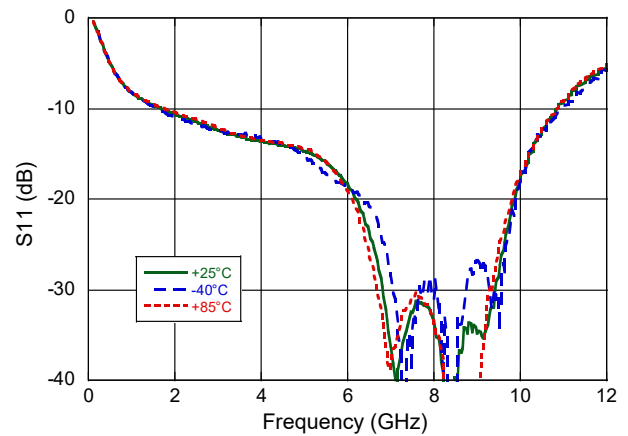

Output Return Loss

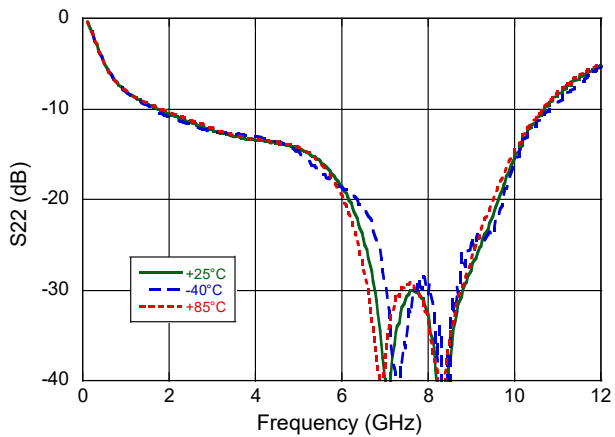

C-Band PIN Diode Limiter

4 - 8 GHz



MADL-011074-DIE

Rev. V1

Typical RF Power Performance, Die On-Board: $Z_0 = 50 \Omega$

CW Flat Leakage Power @ $T_A = 25^\circ\text{C}$

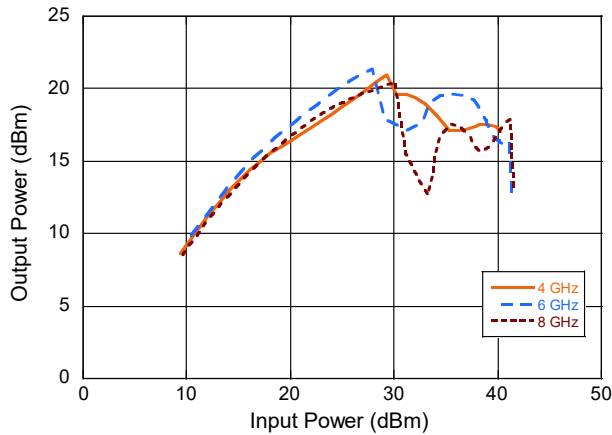

Input IP3 @ $T_A = 25^\circ\text{C}$

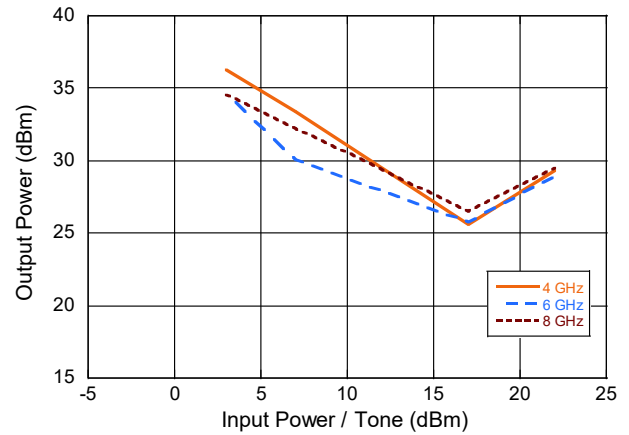

Input IP3 over temperature @ 4 GHz

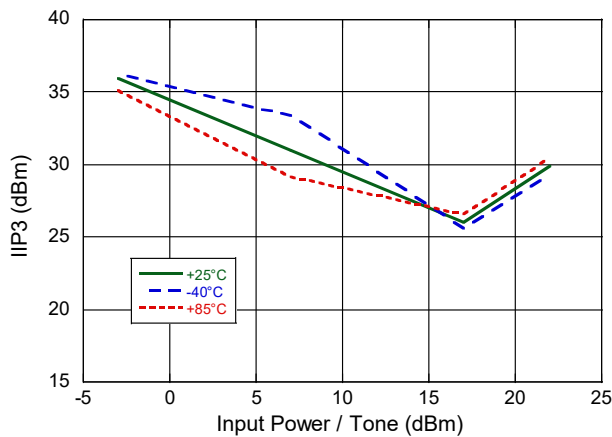

Input IP3 over temperature @ 6 GHz

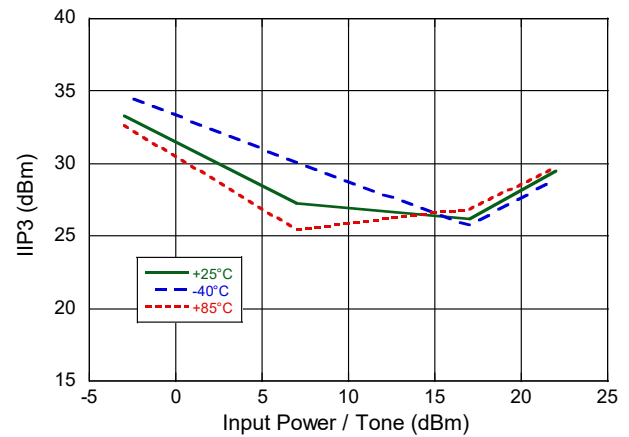

Input IP3 over Temperature @ 8 GHz

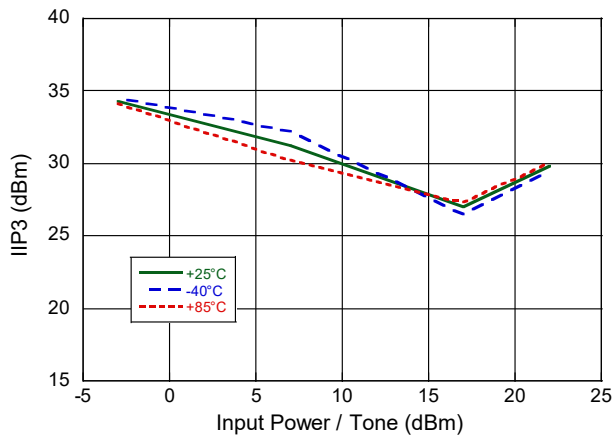

C-Band PIN Diode Limiter

4 - 8 GHz



MADL-011074-DIE

Rev. V1

Die Outline Drawing

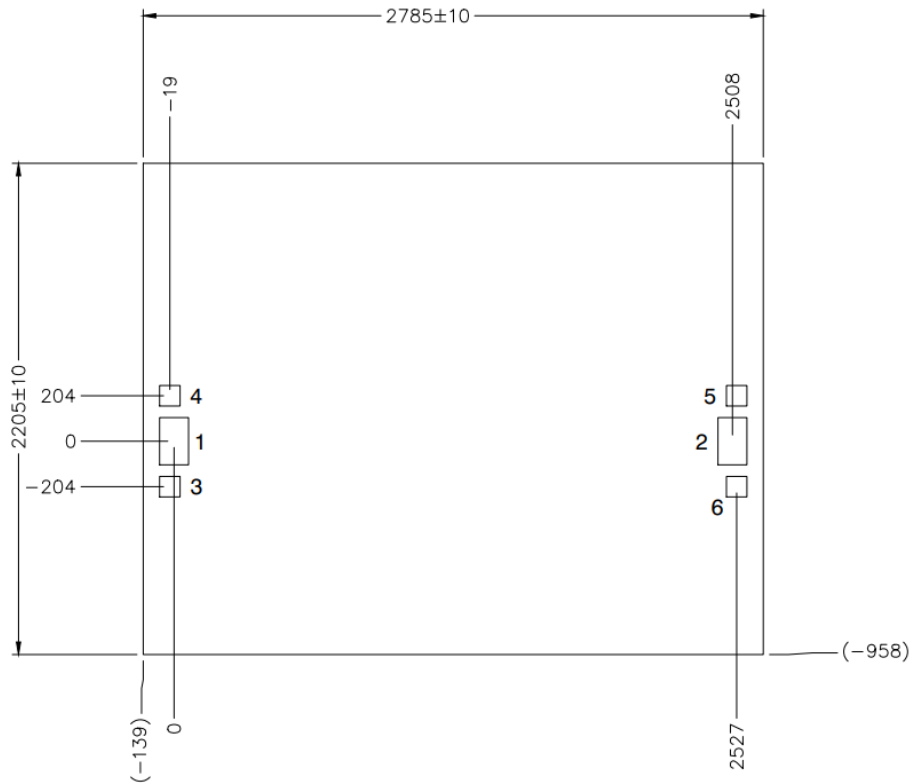

BOND PAD DIM (μm)		
PAD	X	Y
1,2	130	212
3,4,5,6	92	92

NOTES:

- UNLESS OTHERWISE SPECIFIED, ALL DIMENSIONS SHOWN ARE μm WITH A TOLERANCE OF $\pm 5 \mu\text{m}$.
- DIE THICKNESS IS $100 \pm 10 \mu\text{m}$.
- BOND PAD/BACKSIDE METALLIZATION: GOLD.

Recommended Die Attachment

The die edge to die attach pad edge is recommended to be 5 mils minimum. High density solid Cu via farm or Solid Cu heat Slug is recommended under the attach pad for optimum thermal heat dissipation. Eutectic die attachment is not recommended for this part. A high thermal conductivity epoxy shall be used. Voiding under the die should be minimized and no voiding should be present under the diode locations.

Wire Bonding Recommendation

For optimum bonding power handling performance & minimum bonding inductance, it is recommended to bond this part with two 3.0 x 0.5 mil gold ribbon wires on both the input and output RF pads. Low loop profile and minimum bond length are recommended.

MACOM Technology Solutions Inc. ("MACOM"). All rights reserved.

These materials are provided in connection with MACOM's products as a service to its customers and may be used for informational purposes only. Except as provided in its Terms and Conditions of Sale or any separate agreement, MACOM assumes no liability or responsibility whatsoever, including for (i) errors or omissions in these materials; (ii) failure to update these materials; or (iii) conflicts or incompatibilities arising from future changes to specifications and product descriptions, which MACOM may make at any time, without notice. These materials grant no license, express or implied, to any intellectual property rights.

THESE MATERIALS ARE PROVIDED "AS IS" WITH NO WARRANTY OR LIABILITY, EXPRESS OR IMPLIED, RELATING TO SALE AND/OR USE OF MACOM PRODUCTS INCLUDING FITNESS FOR A PARTICULAR PURPOSE, MERCHANTABILITY, INFRINGEMENT OF INTELLECTUAL PROPERTY RIGHT, ACCURACY OR COMPLETENESS, OR SPECIAL, INDIRECT, INCIDENTAL, OR CONSEQUENTIAL DAMAGES WHICH MAY RESULT FROM USE OF THESE MATERIALS.

MACOM products are not intended for use in medical, lifesaving or life sustaining applications. MACOM customers using or selling MACOM products for use in such applications do so at their own risk and agree to fully indemnify MACOM for any damages resulting from such improper use or sale.