

## Digital Attenuator, Constant Phase 15.5 dB, 5-Bit, TTL Driver, DC - 4 GHz

Rev. V3

### Features

- Attenuation: 0.5 dB Steps to 15.5 dB
- Minimal Phase Variation over Attenuation Range
- Low DC Power Consumption
- Small Footprint, PQFN Package
- Integral TTL Driver
- 50  $\Omega$  Impedance
- Test Boards are Available
- RoHS\* Compliant

### Description

The MAAD-009170 is a GaAs pHEMT 5-bit digital attenuator with integral TTL driver in an PQFN plastic surface mount package. Step size is 0.5 dB providing a 15.5 dB total attenuation range. This design has been optimized to minimize phase variation over the attenuation range.

MAAD-009170 is ideally suited for use where accuracy, fast switching, very low power consumption and low intermodulation products are required. Typical applications include dynamic range setting in precision receiver circuits and other gain/leveling control circuits.

### Ordering Information<sup>1</sup>

Part Number	Package
MAAD-009170-000100	Bulk Packaging
MAAD-009170-0001TR	1000 piece reel
MAAD-009170-0001TB	Sample Test Board

1. Reference Application Note M513 for reel size information.

### Functional Schematic

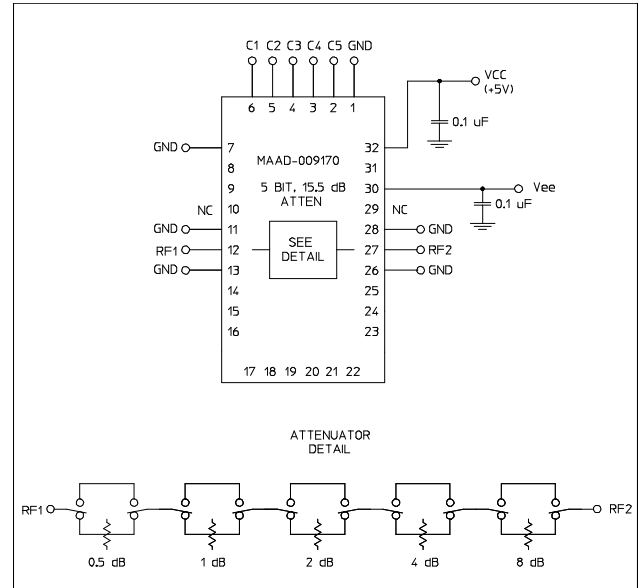

### Pin Configuration<sup>2</sup>

Pin #	Function
1, 7, 11, 13, 26, 28	GND
2	C5
3	C4
4	C3
5	C2
6	C1
8, 9, 14 - 25, 31	NC
10, 29	NC <sup>3</sup>
12	RF1
27	RF2
30	Vee
32	+Vcc

2. The exposed pad centered on the package bottom must be connected to RF and DC ground.  
3. Pins 10 & 29 must be isolated.

\* Restrictions on Hazardous Substances, compliant to current RoHS EU directive.

## Digital Attenuator, Constant Phase 15.5 dB, 5-Bit, TTL Driver, DC - 4 GHz

Rev. V3

Electrical Specifications:  $T_A = 25^\circ\text{C}$ ,  $Z_0 = 50 \Omega$ ,  $V_{CC} = +5 \text{ V}$ ,  $V_{EE} = -5 \text{ V}$

Parameter	Test Conditions	Units	Min.	Typ.	Max.
Operating Power <sup>4</sup>	—	dBm	—	—	20
Reference Insertion Loss	DC - 2.0 GHz 2.0 - 4.0 GHz	dB	—	—	4.7 5.2
Attenuation <sup>5</sup>	Above Loss, DC - 4.0 GHz 0.5 dB 1.0 dB 2.0 dB 4.0 dB 8.0 dB 15.5 dB	dB	0.24 0.73 1.71 3.67 7.59 14.94	—	0.76 1.27 2.29 4.33 8.41 16.20
Phase Accuracy Relative to Reference Loss State	Any Single Bit DC - 2.0 GHz 2.0 - 4.0 GHz Any Combination of Bits DC - 2.0 GHz 2.0 - 4.0 GHz	°	—	—	±2 ±3 ±4 ±7
VSWR	Full Range DC - 4.0 GHz	Ratio	—	—	1.9:1
Switching Speed $T_{ON}$ $T_{OFF}$ $T_{RISE}$ $T_{FALL}$	1.3 V Cntl to 90% RF 1.3 V Cntl to 10% RF 10% RF to 90% RF 90% RF to 10% RF	ns	—	47 24 23 13	—
1 dB Compression <sup>6</sup>	Reference State 0.05 GHz 0.5 - 4.0 GHz	dBm	—	+26 +26	—
Input IP3	Two-tone inputs up to +5 dBm 0.05 GHz 0.5 - 4.0 GHz	dBm	—	+43 +40	—
Input IP2	Two-tone inputs up to +5 dBm 0.05 GHz 0.5 - 4.0 GHz	dBm	—	+50 +72	—
$V_{CC}$ $V_{EE}$	—	V	4.5 -8.0	5.0 -5.0	5.5 -4.5
$V_{IL}$ $V_{IH}$	LOW-level input voltage HIGH-level input voltage	V	0.0 2.0	0.0 5.0	0.8 5.0
$I_{IN}$ (Input Leakage Current)	$V_{IN} = V_{CC}$ or GND	μA	-1.0	—	1.0
$I_{CC}$ (Quiescent Supply Current)	$V_{cntrl} = V_{CC}$ or GND	μA	—	250	400
$\Delta I_{CC}$ (Additional Supply Current Per TTL Input Pin)	$V_{CC} = \text{Max.}$ $V_{cntrl} = V_{CC} - 2.1 \text{ V}$	mA	—	—	1.0
$I_{EE}$	$V_{EE}$ min. to max, $V_{IN} = V_{IL}$ or $V_{IH}$	mA	-1.0	-0.2	—
Thermal Resistance ( $\theta_{JC}$ )	—	°C/W	—	35	—

4. Maximum operating power is specified with the input applied to RF1. If the input is applied to RF2, then maximum operating power is 16 dBm.

5. This attenuator is guaranteed monotonic.

2 6. 1 dB Compression was measured up to 26 dBm, which is the absolute maximum rating for this device.

MACOM Technology Solutions Inc. (MACOM) and its affiliates reserve the right to make changes to the product(s) or information contained herein without notice. Visit [www.macom.com](http://www.macom.com) for additional data sheets and product information.

## Digital Attenuator, Constant Phase 15.5 dB, 5-Bit, TTL Driver, DC - 4 GHz

Rev. V3

### Absolute Maximum Ratings<sup>7,8</sup>

Parameter	Absolute Maximum
Input Power <sup>9</sup> DC - 4.0 GHz	+26 dBm
$V_{CC}$	$-0.5 V \leq V_{CC} \leq +7.0 V$
$V_{EE}$	$-8.5 V \leq V_{EE} \leq +0.5 V$
$V_{CC} - V_{EE}$	$-0.5 V \leq V_{CC} - V_{EE} \leq 14.5 V$
$V_{IN}$ <sup>10</sup>	$-0.5 V \leq V_{in} \leq V_{CC} + 0.5 V$
Operating Temperature	-40°C to +85°C
Storage Temperature	-65°C to +125°C

7. Exceeding any one or combination of these limits may cause permanent damage to this device.
8. MACOM does not recommend sustained operation near these survivability limits.
9. The maximum operating power is specified with the input applied to RF1. If the input is applied to RF2, then maximum operating power is +22 dBm
10. Standard CMOS TTL interface, latch-up will occur if logic signal is applied prior to power supply.

### Recommended PCB Configuration<sup>11</sup>

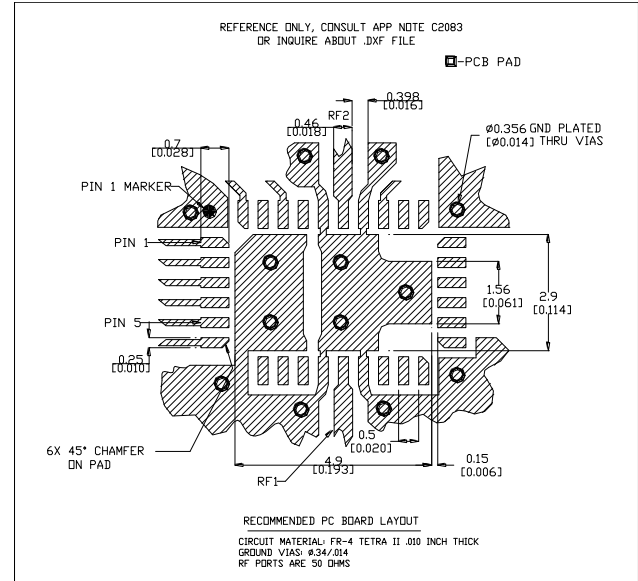

11. Application Note S2083 is available on the MACOM website.

### Handling Procedures

Please observe the following precautions to avoid damage:

### Static Sensitivity

Gallium Arsenide Integrated Circuits are sensitive to electrostatic discharge (ESD) and can be damaged by static electricity. Proper ESD control techniques should be used when handling these devices.

### Moisture Sensitivity

The MSL rating for this part is defined as Level 2 per IPC/JEDEC J-STD-020. Parts shall be stored and/or baked as required for MSL Level 2 parts.

### Truth Table (Digital Attenuator)<sup>12</sup>

C5	C4	C3	C2	C1	Attenuation
0	0	0	0	0	Loss, Reference
0	0	0	0	1	0.5 dB
0	0	0	1	0	1.0 dB
0	0	1	0	0	2.0 dB
0	1	0	0	0	4.0 dB
1	0	0	0	0	8.0 dB
1	1	1	1	1	15.5 dB

12. 0 = TTL Low; 1 = TTL High

## Typical Performance Curves

Reference Loss vs. Frequency

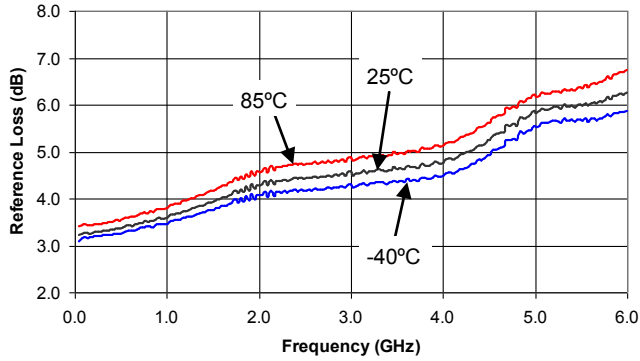

Attenuation - 0.5 dB Bit vs. Frequency

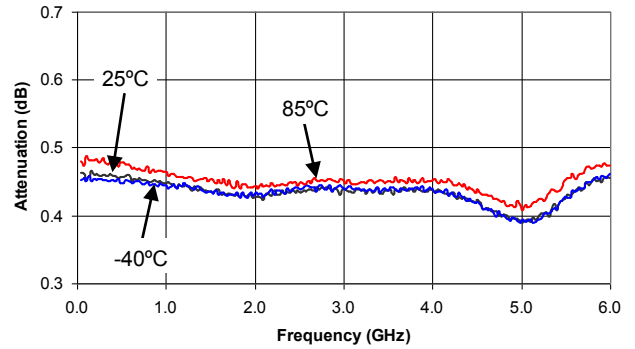

Attenuation - 1 dB Bit vs. Frequency

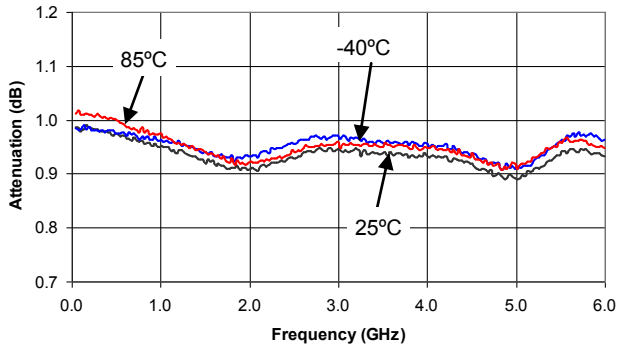

Attenuation - 2 dB Bit vs. Frequency

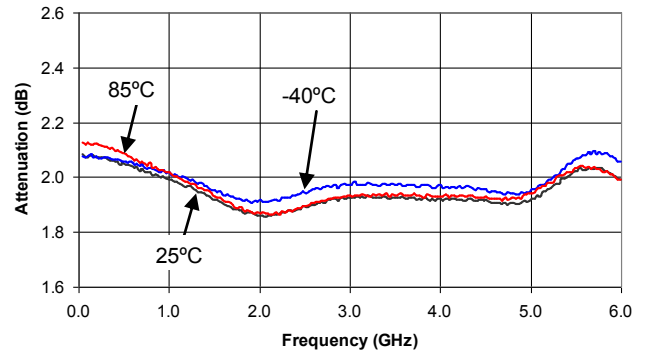

Attenuation - 4 dB Bit vs. Frequency

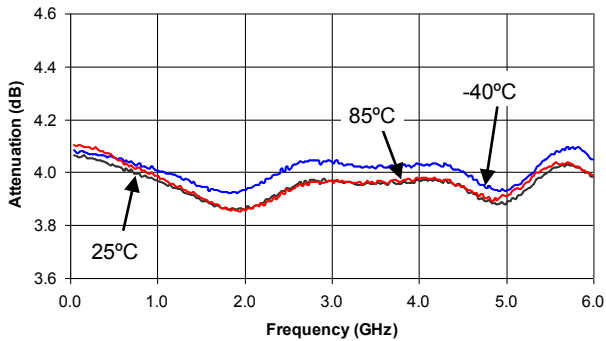

Attenuation - 8 dB Bit vs. Frequency

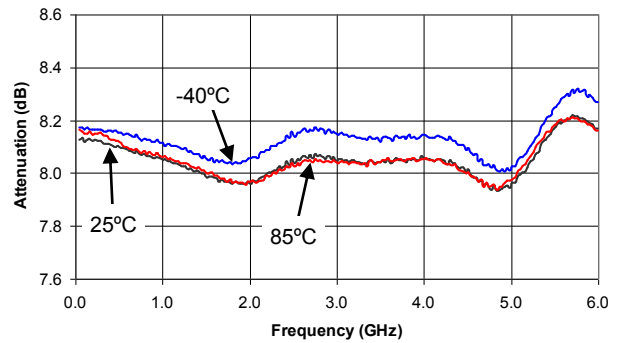

## Digital Attenuator, Constant Phase 15.5 dB, 5-Bit, TTL Driver, DC - 4 GHz

Rev. V3

### Typical Performance Curves

**Attenuation - 15.5 dB Attenuation vs. Frequency**

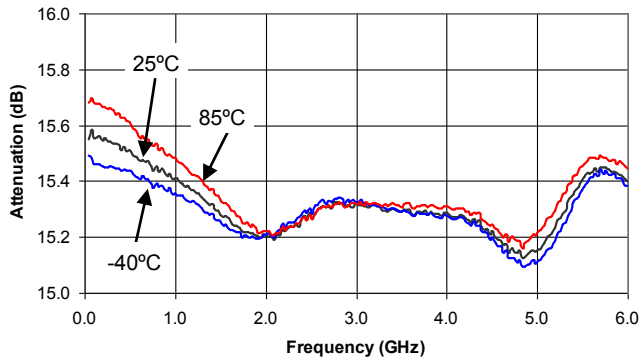

**Phase - 0.5 dB Bit vs. Frequency  
Relative to Reference Loss State**

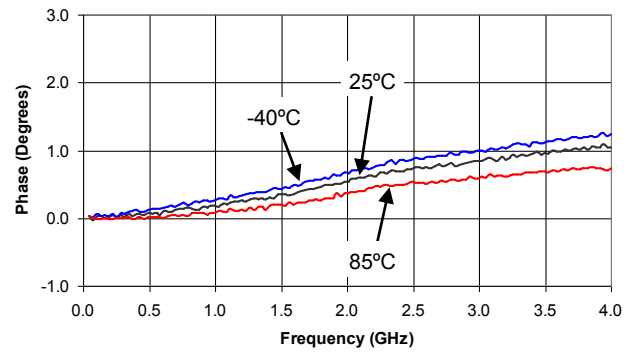

**Phase - 1 dB Bit vs. Frequency  
Relative to Reference Loss State**

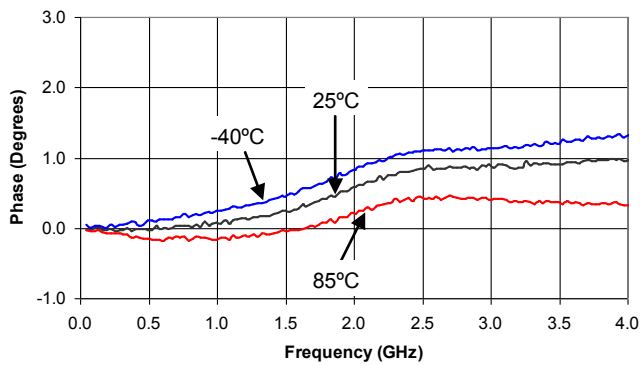

**Phase - 2 dB Bit vs. Frequency  
Relative to Reference Loss State**

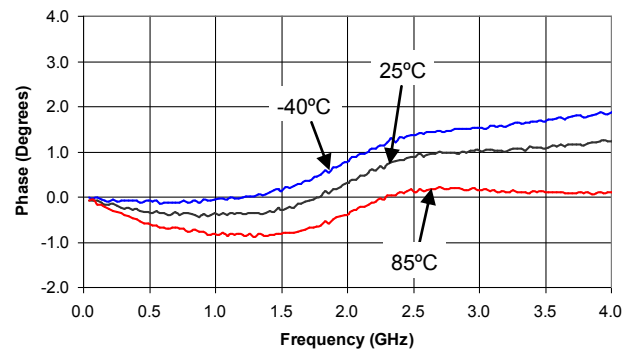

**Phase - 4 dB Bit vs. Frequency  
Relative to Reference Loss State**

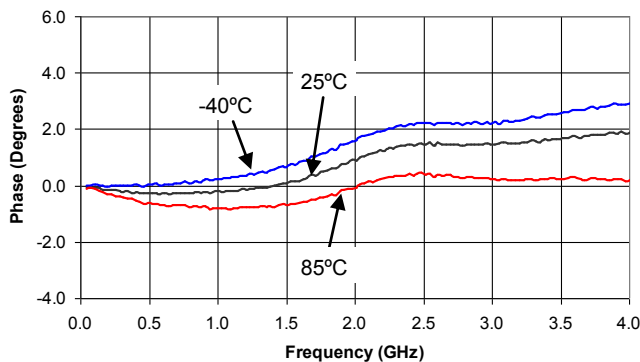

**Phase - 8 dB Bit vs. Frequency  
Relative to Reference Loss State**

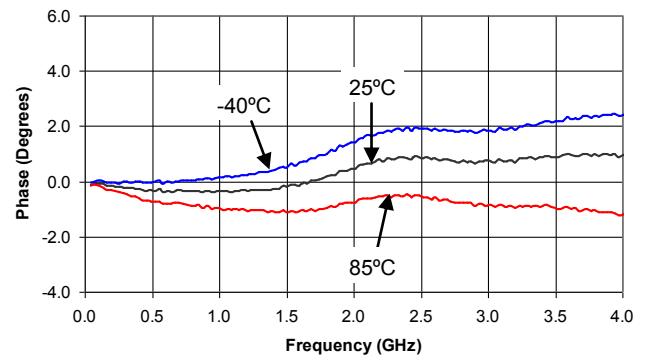

## Typical Performance Curves

**Phase - 15.5 dB Attenuation vs. Frequency**  
**Relative to Reference Loss State**

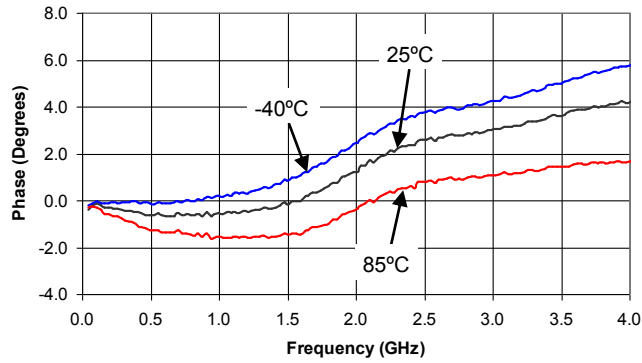

**VSWR - Reference State vs. Frequency**

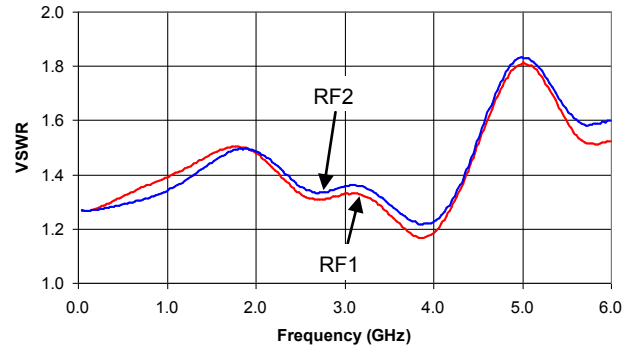

**VSWR - 0.5 dB Bit vs. Frequency**

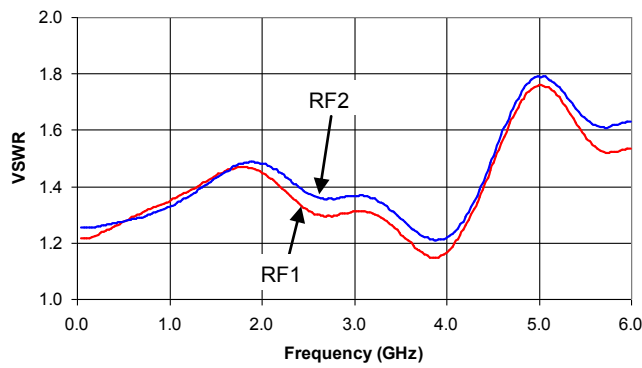

**VSWR - 1 dB Bit vs. Frequency**

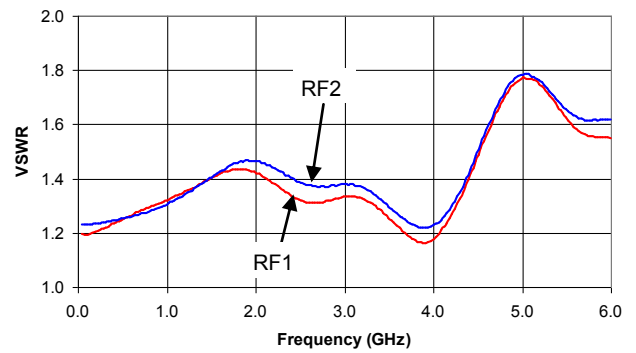

**VSWR - 2 dB Bit vs. Frequency**

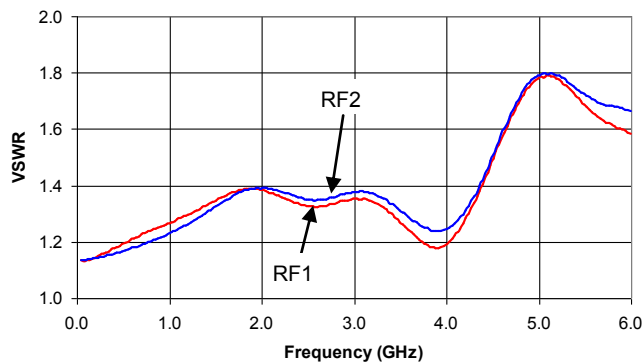

**VSWR - 4 dB Bit vs. Frequency**

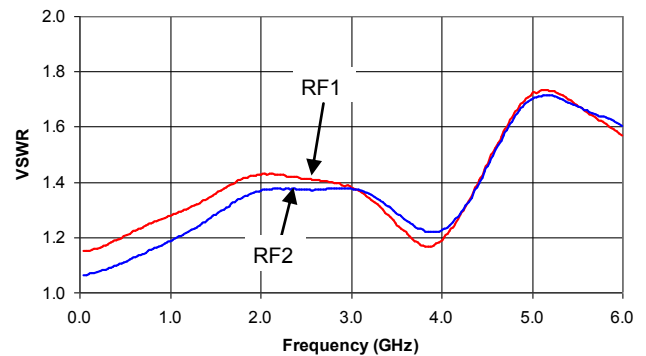

## Typical Performance Curves

*VSWR - 8 dB Bit vs. Frequency*

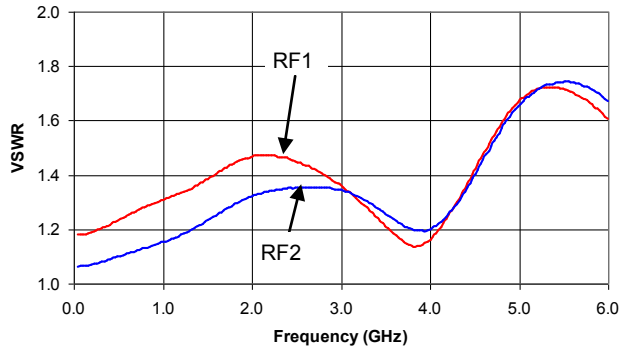

*VSWR - 15.5 dB Attenuation vs. Frequency*

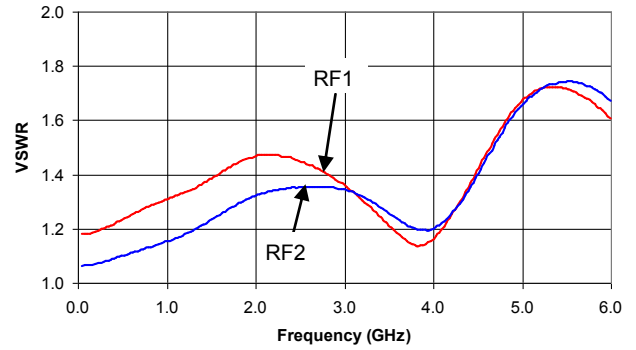

## Typical Input IP2 and IP3 at Room Temperature<sup>13</sup>

Attenuation	IP2			IP3			Units
	50 MHz	500 MHz	2 GHz	50 MHz	500 MHz	2 GHz	
Reference State	50	72	73	43	40	44	dBm
0.5 dB	51	73	74	43	41	44	dBm
1 dB	51	73	75	43	41	44	dBm
2 dB	51	73	74	43	41	45	dBm
4 dB	51	73	74	43	41	45	dBm
8 dB	50	71	75	41	43	41	dBm
15.5 dB	53	74	79	43	42	44	dBm

13. IP2 and IP3 are measured with two-tone inputs F1 and F2 up to +5 dBm with 1 MHz spacing.

**Digital Attenuator, Constant Phase**  
**15.5 dB, 5-Bit, TTL Driver, DC - 4 GHz**

Rev. V3

**CSP-1, 4 x 6 mm, 32-lead PQFN†**

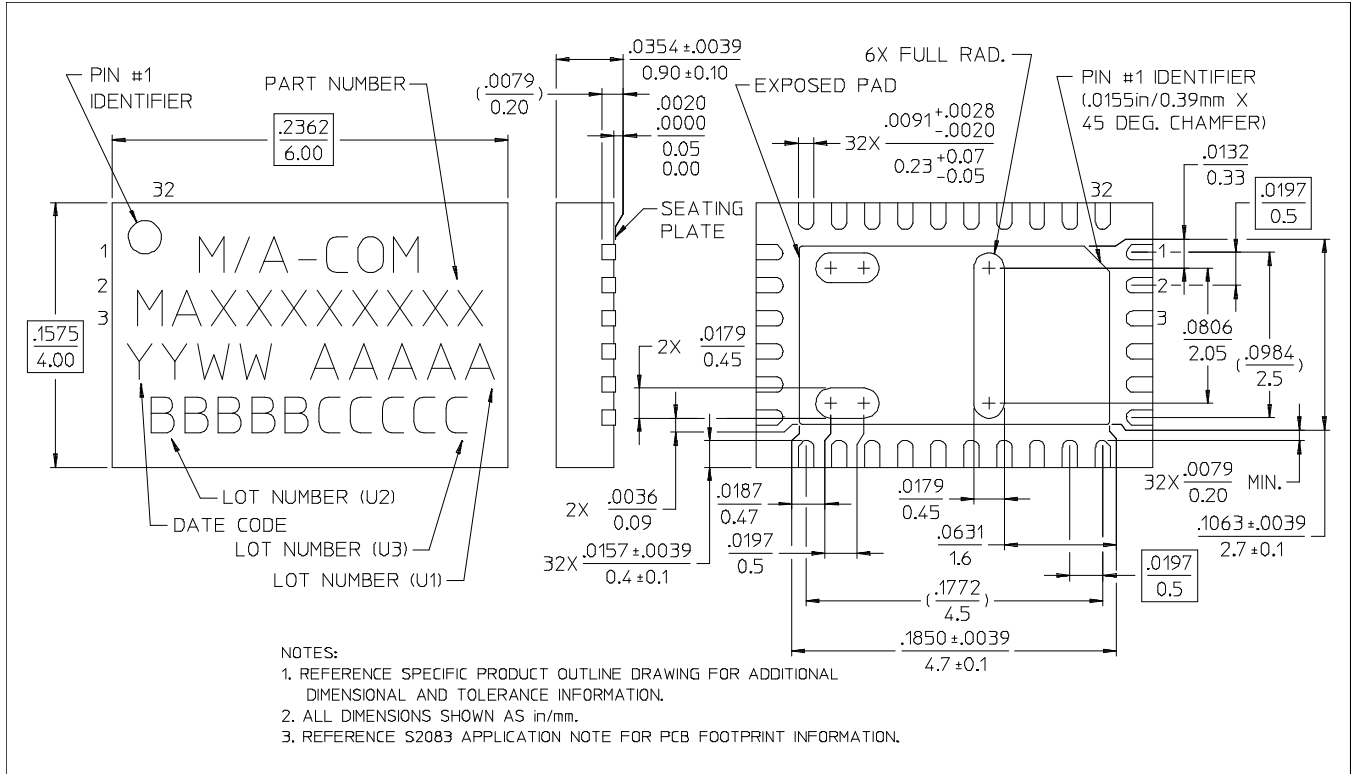

† Reference Application Note M538 for lead-free solder reflow recommendations.



MACOM Technology Solutions Inc. All rights reserved.

Information in this document is provided in connection with MACOM Technology Solutions Inc ("MACOM") products. These materials are provided by MACOM as a service to its customers and may be used for informational purposes only. Except as provided in MACOM's Terms and Conditions of Sale for such products or in any separate agreement related to this document, MACOM assumes no liability whatsoever. MACOM assumes no responsibility for errors or omissions in these materials. MACOM may make changes to specifications and product descriptions at any time, without notice. MACOM makes no commitment to update the information and shall have no responsibility whatsoever for conflicts or incompatibilities arising from future changes to its specifications and product descriptions. No license, express or implied, by estoppel or otherwise, to any intellectual property rights is granted by this document.

THESE MATERIALS ARE PROVIDED "AS IS" WITHOUT WARRANTY OF ANY KIND, EITHER EXPRESS OR IMPLIED, RELATING TO SALE AND/OR USE OF MACOM PRODUCTS INCLUDING LIABILITY OR WARRANTIES RELATING TO FITNESS FOR A PARTICULAR PURPOSE, CONSEQUENTIAL OR INCIDENTAL DAMAGES, MERCHANTABILITY, OR INFRINGEMENT OF ANY PATENT, COPYRIGHT OR OTHER INTELLECTUAL PROPERTY RIGHT. MACOM FURTHER DOES NOT WARRANT THE ACCURACY OR COMPLETENESS OF THE INFORMATION, TEXT, GRAPHICS OR OTHER ITEMS CONTAINED WITHIN THESE MATERIALS. MACOM SHALL NOT BE LIABLE FOR ANY SPECIAL, INDIRECT, INCIDENTAL, OR CONSEQUENTIAL DAMAGES, INCLUDING WITHOUT LIMITATION, LOST REVENUES OR LOST PROFITS, WHICH MAY RESULT FROM THE USE OF THESE MATERIALS.

MACOM products are not intended for use in medical, lifesaving or life sustaining applications. MACOM customers using or selling MACOM products for use in such applications do so at their own risk and agree to fully indemnify MACOM for any damages resulting from such improper use or sale.