



# TAOGLAS®



## Datasheet

### Colosseum

**Part No:**  
MA841.A.BI.002

#### **Description:**

Colosseum MA841 2in1 5G/4G MIMO Permanent Mount Antenna

#### **Features:**

2\* 5G/4G MIMO 600~6000MHz  
Screw-Mount [Permanent Mount]  
Worldwide 5G/4G Bands  
IP67 Rated Enclosure  
Dimensions: Diameter: 94.3mm, Height: 57.4 mm  
1m RG-316 with SMA(M) connectors as standard  
Custom Cables and Connectors Available  
RoHS & Reach Compliant

1. Introduction	3
2. Specifications	4
3. Antenna Characteristics	7
4. Radiation Patterns	10
5. Mechanical Drawing	43
6. Installation Guide	44
<hr/>	
7. Packaging	45
<hr/>	
Changelog	46

Taoglas makes no warranties based on the accuracy or completeness of the contents of this document and reserves the right to make changes to specifications and product descriptions at any time without notice. Taoglas reserves all rights to this document and the information contained herein.

Reproduction, use or disclosure to third parties without express permission is strictly prohibited.



# 1. Introduction



The Colosseum MA841 antenna is a low profile, heavy-duty, fully IP67 waterproof external M2M antenna for use in worldwide telematics applications which require best in class 5G/4G LTE MIMO performance.

This unique product, only 57.4mm height, delivers powerful worldwide 5G/4G MIMO antenna technology from 600 to 6000MHz, so it provides coverage to all bands within that spectrum to maintain a stable connection over the lifetime of your system.

#### Typical applications

- Remote Asset and Pipeline Monitoring
- Digital Signage
- HD Video over LTE
- First Responder and Emergency Services
- Automotive Vehicle Tracking and Telematics

5G/4G applications demand high speed data uplink and downlink. High efficiency and high gain MIMO antennas are necessary to achieve the required signal to noise ratio and throughput required to solve these challenges. Taoglas also takes care to have high isolation between the two MIMO antennas to prevent self-interference. Low loss cables are used to keep efficiency high over long cable lengths. In contrast, smaller MIMO antennas with poorer quality thinner cables will have much reduced efficiency and isolation, which would lead to a large drop in system throughput or drops and may indeed not make a system connection at all.

Cable length and connector types are customizable. Contact your regional Taoglas customer support team for installation instructions or further support.

## 2. Specifications

Electrical								
Band	Frequency (MHz)		Efficiency (%)	Average Gain (dB)	Peak Gain (dBi)	Impedance	VSWR	Polarization
5G NR/4G Band 71	617~698	LTE 1	27	-5.8	0.59	50Ω	< 3	Linear
		LTE 2	20	-7.1	1.48			
4G/3G Band 12,13,14,17,28,29	698~806	LTE 1	37	-4.3	2.70			
		LTE 2	20	-7.1	2.57			
4G/3G/NB-IoT/Cat M Band 5,8,18,19,20,26,27	824~960	LTE 1	36	-4.4	2.13			
		LTE 2	31	-5.3	2.00			
5G NR/4G Band 21,32,74,75,76	1427~1518	LTE 1	30	-5.4	1.66			
		LTE 2	26	-5.9	2.02			
4G/3G Band 1,2,3,4,9,23,25,35,39,66	1710~2200	LTE 1	47	-3.6	4.88			
		LTE 2	39	-4.1	4.88			
4G/3G Band 7,30,38,40,41	2300~2690	LTE 1	46	-3.4	6.77			
		LTE 2	46	-3.3	6.74			
5G NR/4G Band 22,42,48,77,78,79	3300~4200	LTE 1	44	-3.6	5.33			
		LTE 2	40	-4.1	5.39			
LTE5200/ Wi-Fi 5800	5150~5925	LTE 1	36	-4.4	3.95			
		LTE 2	27	-5.7	3.71			

\*Tested with 300mm Cable

<b>Mechanical</b>	
Dimensions	Diameter: 94.3mm, Height: 57.4 mm
Casing	ASA
Base and thread	Zinc Alloy
Weight	250g
Ingress Protection Rating	IP69K
Recommended Troque for Mounting	5-7 N•m
Cable	0.3m RG-316 standard, fully customizable
Connectors	SMA(M) standard, fully customizable
<b>Environmental</b>	
Operation Temperature	-40°C to 85°C
Storage Temperature	-40°C to 85°C
Humidity	Non-condensing 65°C 95% RH

5G/4G Bands			
Band Number	5G NR / FR1 / LTE / LTE-Advanced / WCDMA / HSPA / HSPA+ / TD-SCDMA		
	Uplink	Downlink	Covered
1	UL: 1920 to 1980	DL: 2110 to 2170	✓
2	UL: 1850 to 1910	DL: 1930 to 1990	✓
3	UL: 1710 to 1785	DL: 1805 to 1880	✓
4	UL: 1710 to 1755	DL: 2110 to 2155	✓
5	UL: 824 to 849	DL: 869 to 894	✓
7	UL: 2500 to 2570	DL: 2620 to 2690	✓
8	UL: 880 to 915	DL: 925 to 960	✓
9	UL: 1749.9 to 1784.9	DL: 1844.9 to 1879.9	✓
11	UL: 1427.9 to 1447.9	DL: 1475.9 to 1495.9	✓
12	UL: 699 to 716	DL: 729 to 746	✓
13	UL: 777 to 787	DL: 746 to 756	✓
14	UL: 788 to 798	DL: 758 to 768	✓
17	UL: 704 to 716	DL: 734 to 746	✓
18	UL: 815 to 830	DL: 860 to 875	✓
19	UL: 830 to 845	DL: 875 to 890	✓
20	UL: 832 to 862	DL: 791 to 821	✓
21	UL: 1447.9 to 1462.9	DL: 1495.9 to 1510.9	✓
22	UL: 3410 to 3490	DL: 3510 to 3590	✓
23	UL: 2000 to 2020	DL: 2180 to 2200	✓
24	UL: 1625.5 to 1660.5	DL: 1525 to 1559	✓
25	UL: 1850 to 1915	DL: 1930 to 1995	✓
26	UL: 814 to 849	DL: 859 to 894	✓
27	UL: 807 to 824	DL: 852 to 869	✓
28	UL: 703 to 748	DL: 758 to 803	✓
29	UL: -	DL: 717 to 728	✓
30	UL: 2305 to 2315	DL: 2350 to 2360	✓
31	UL: 452.5 to 457.5	DL: 462.5 to 467.5	✗
32	UL: -	DL: 1452 - 1496	✓
35		1850 to 1910	✓
38		2570 to 2620	✓
39		1880 to 1920	✓
40		2300 to 2400	✓
41		2496 to 2690	✓
42		3400 to 3600	✓
43		3600 to 3800	✓
48		3550 to 3700	✓
66	UL: 1710-1780	DL: 2110-2200	✓
71		617 to 698	✓
74/75/76		1427 to 1518	✓
78		3300 to 3800	✓
79		4400 to 5000	✓
85	698-716	728-746	✓

### 3. Antenna Characteristics

#### 3.1 Return Loss

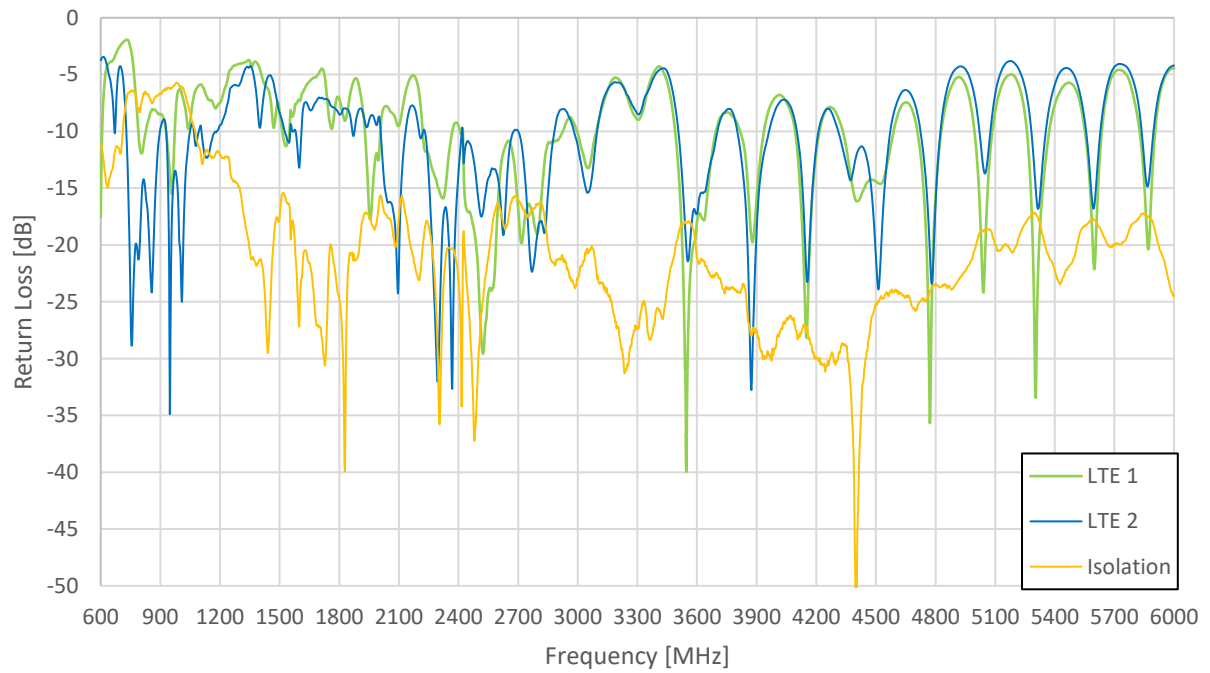

#### 3.2 Efficiency

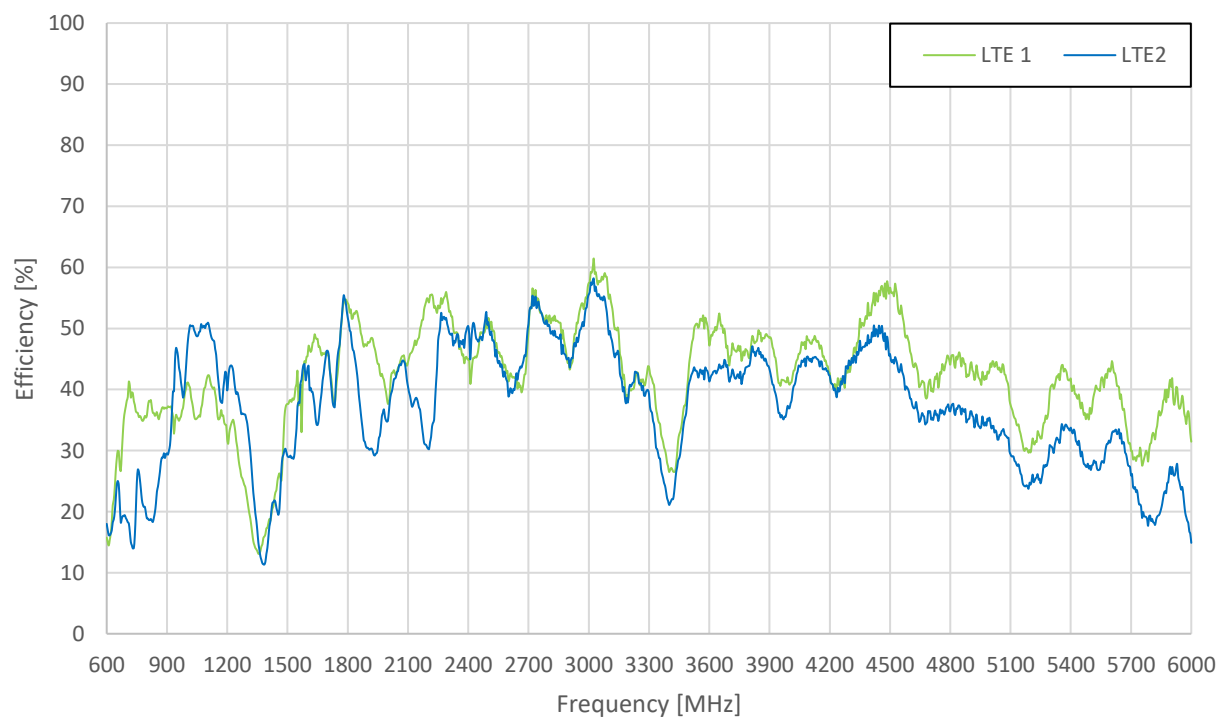

### 3.3 Average Gain

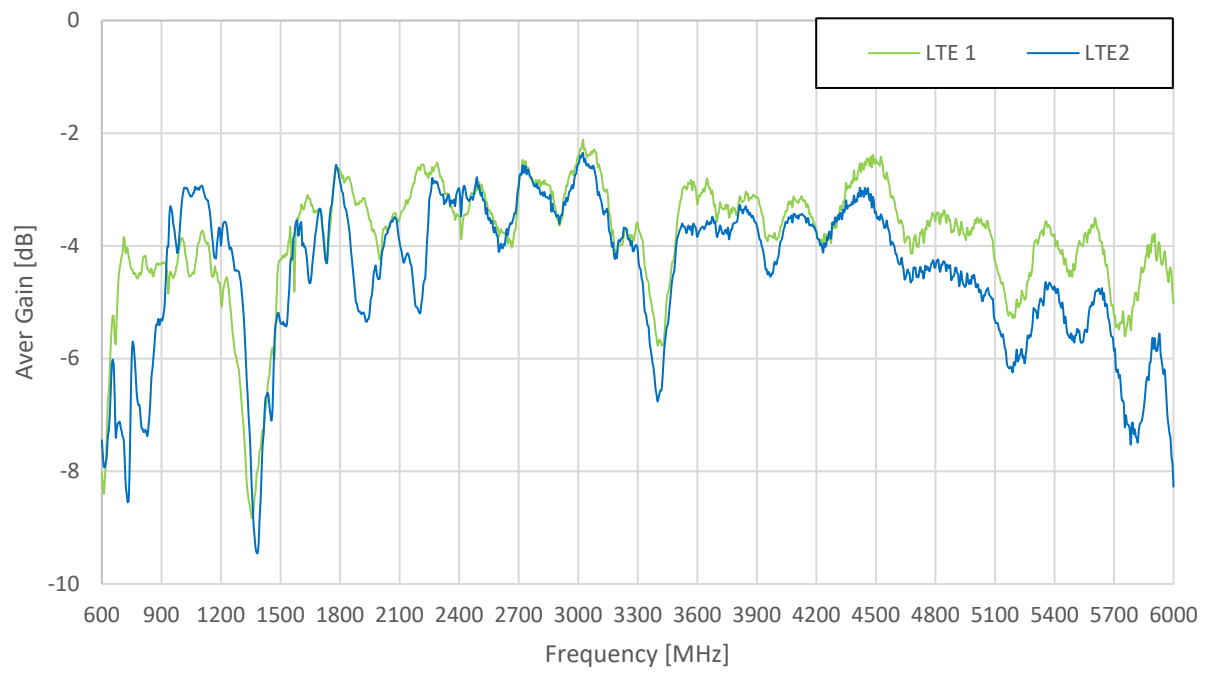

### 3.4 Peak Gain

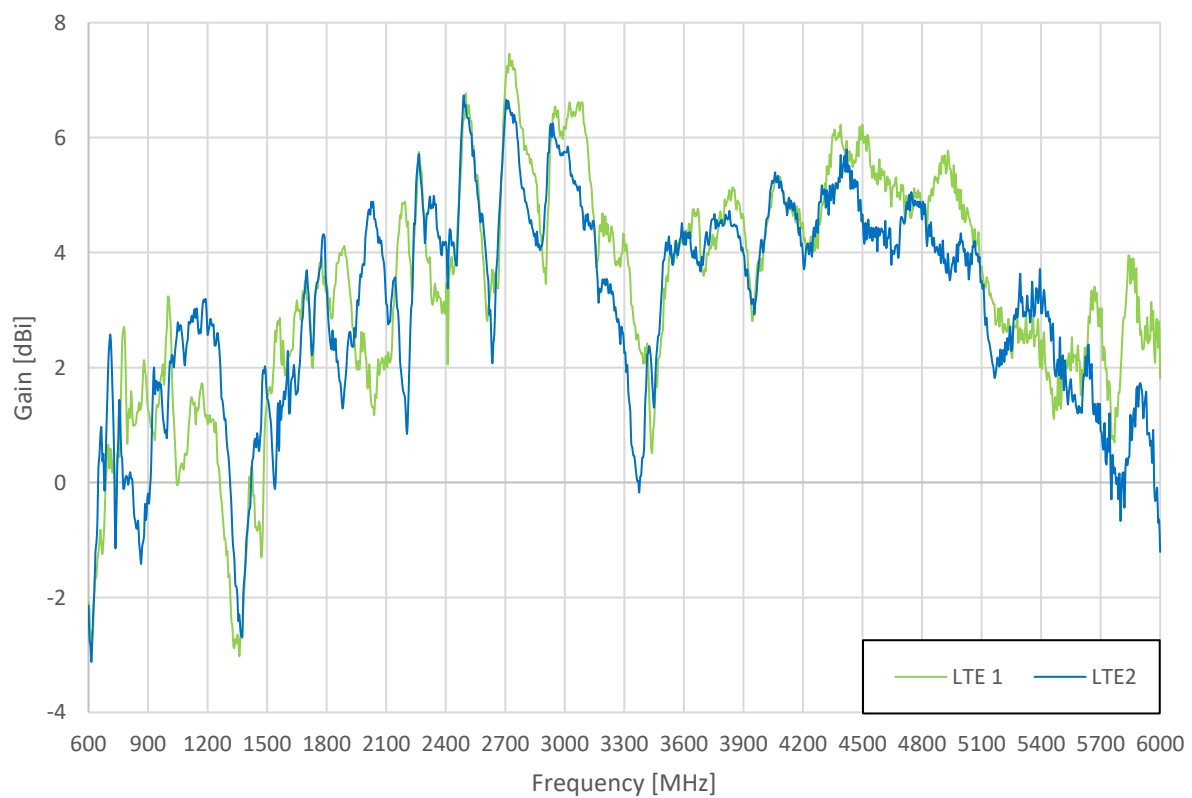



3.5 ECC

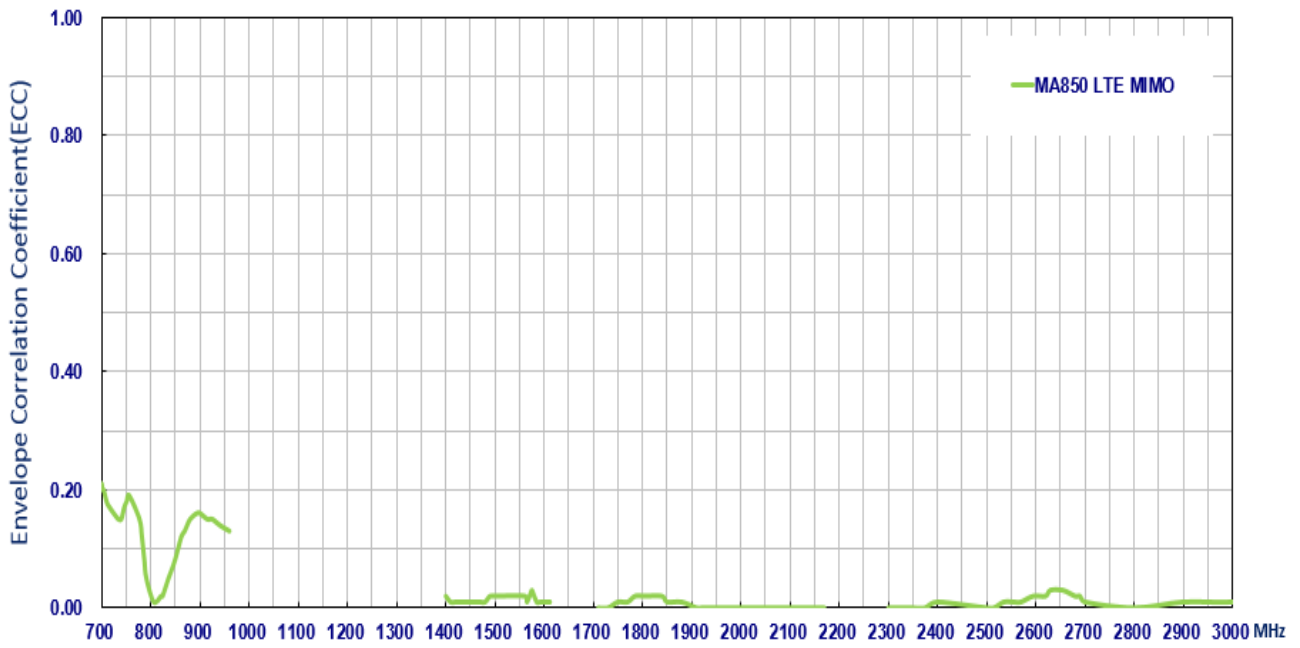

## 4. Radiation Patterns

### 4.1 Test Setup

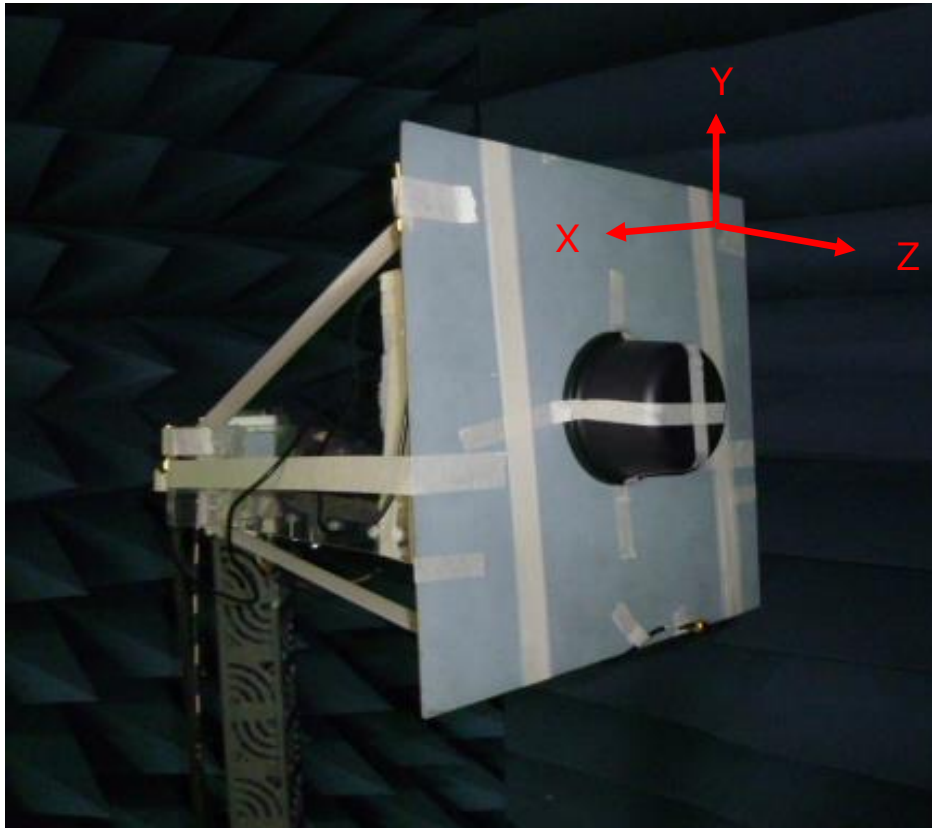

300 x 300mm Ground Plane

4.2 LTE1 – 705MHz 3D and 2D Radiation Patterns

Azimuth = 0.0  
Elevation = 0.0  
Roll = -35.0

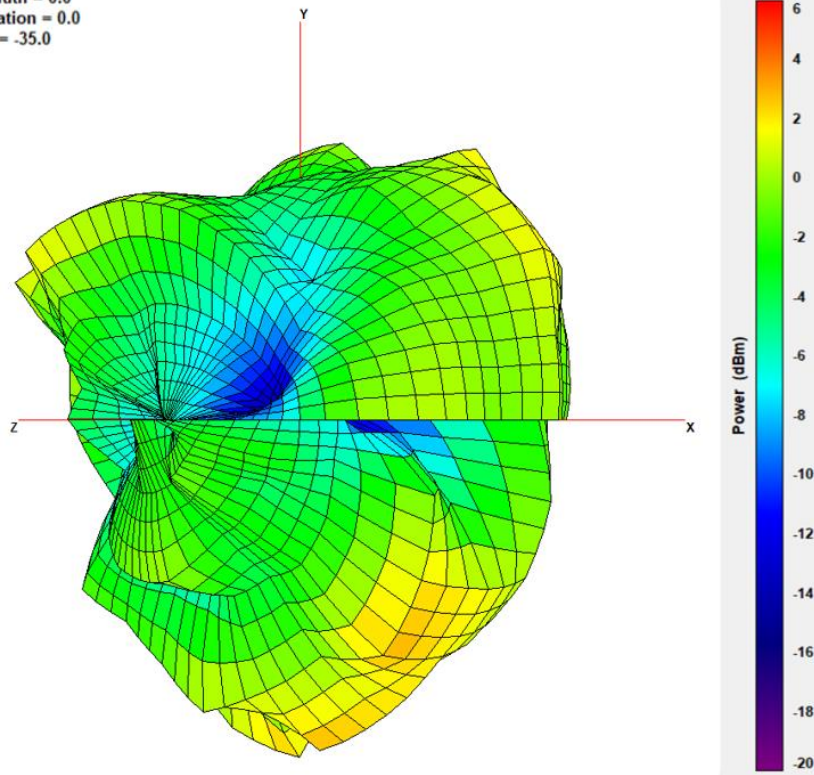

XY Plane

XZ Plane

YZ Plane

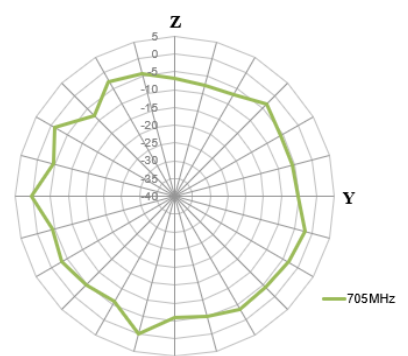
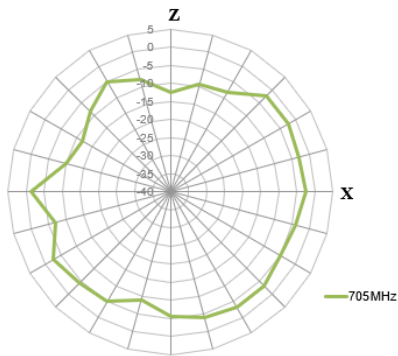
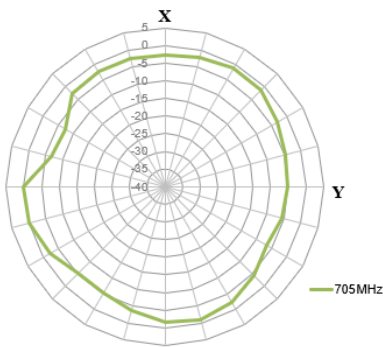

750MHz

Azimuth = 0.0  
Elevation = 0.0  
Roll = -35.0

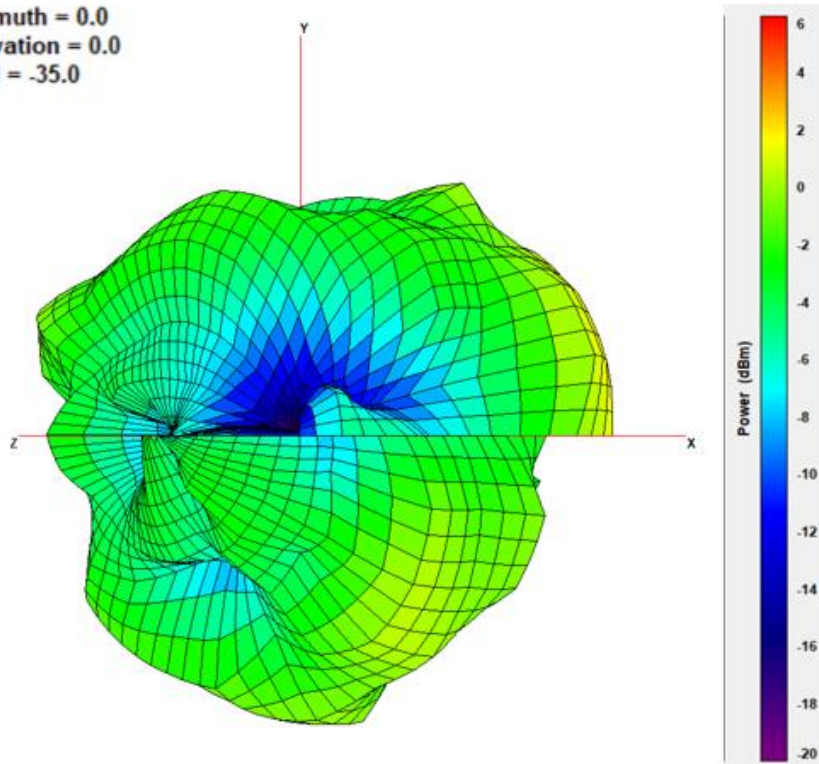

XY Plane

XZ Plane

YZ Plane

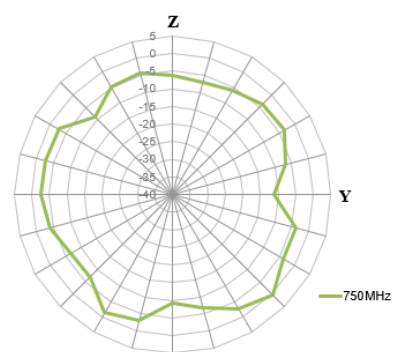
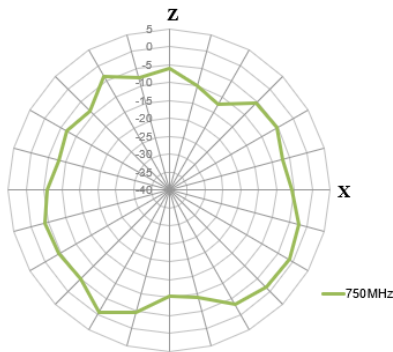
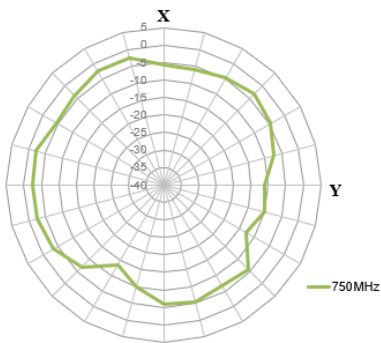

825MHz

Azimuth = 0.0  
 Elevation = 0.0  
 Roll = -35.0

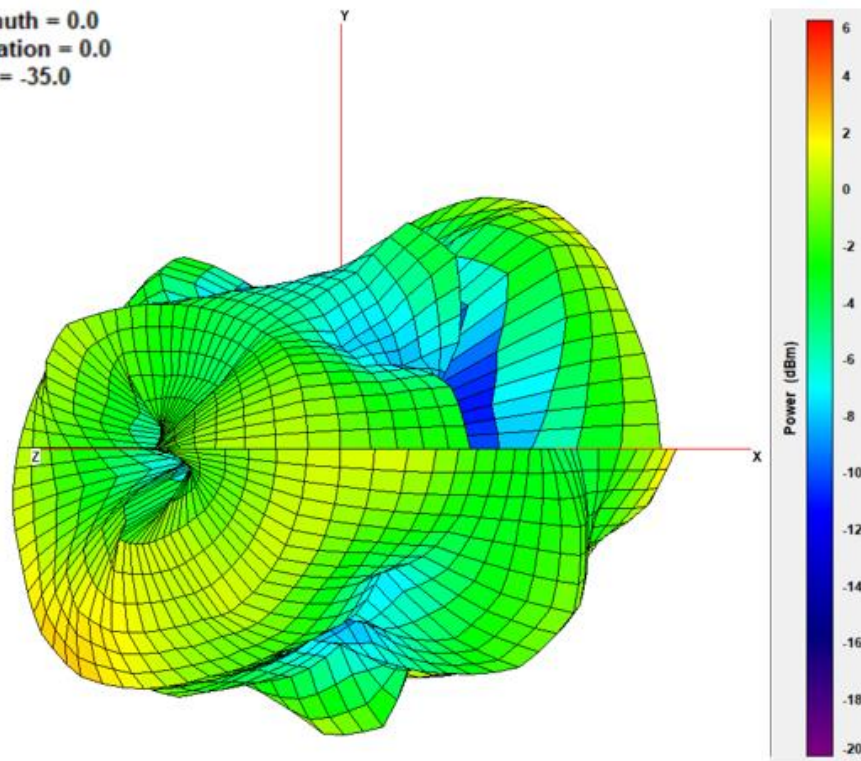

XY Plane

XZ Plane

YZ Plane

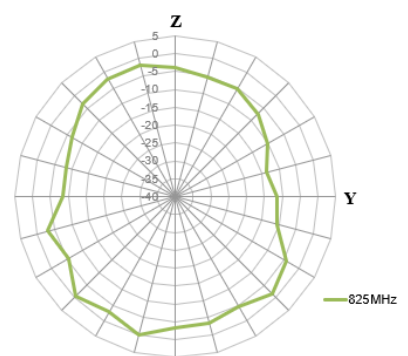
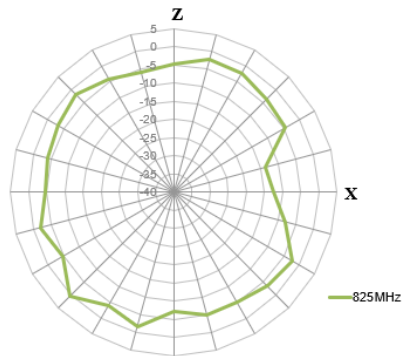
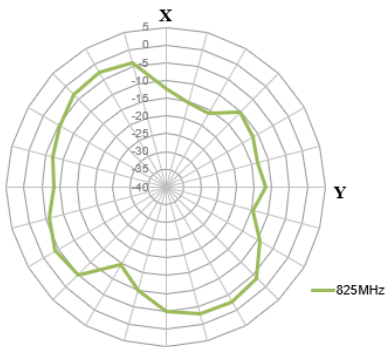

880MHz

Azimuth = 0.0  
Elevation = 0.0  
Roll = -35.0

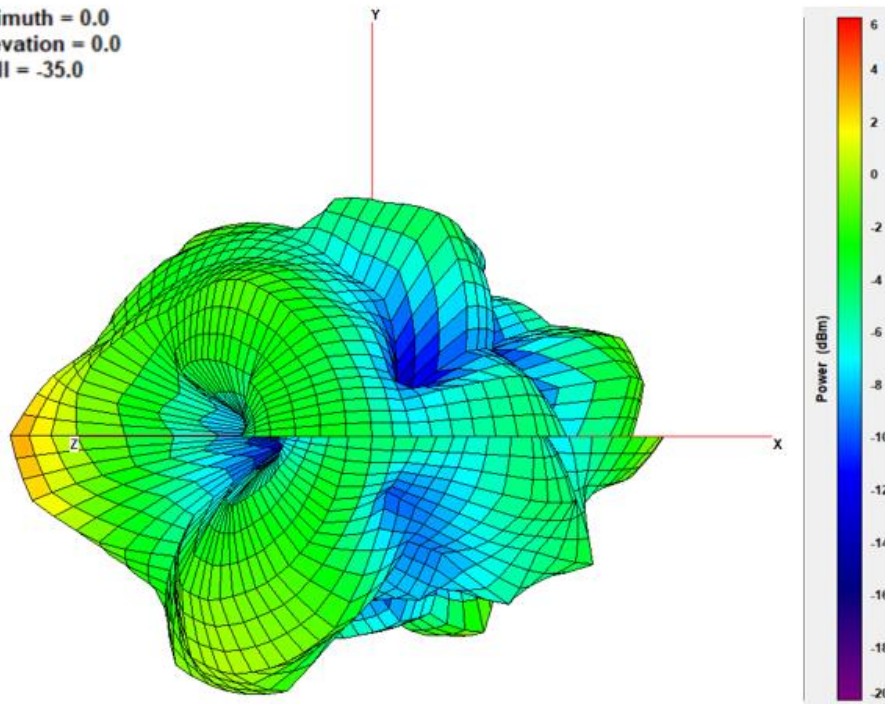

XY Plane

XZ Plane

YZ Plane

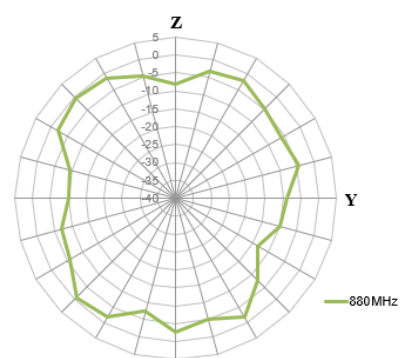
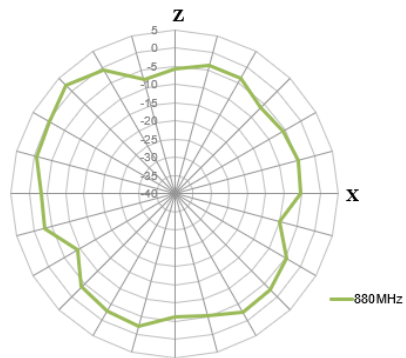
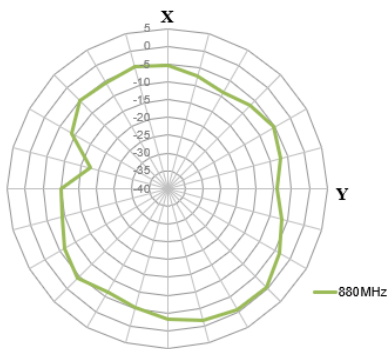

960MHz

Azimuth = 0.0  
Elevation = 0.0  
Roll = -35.0

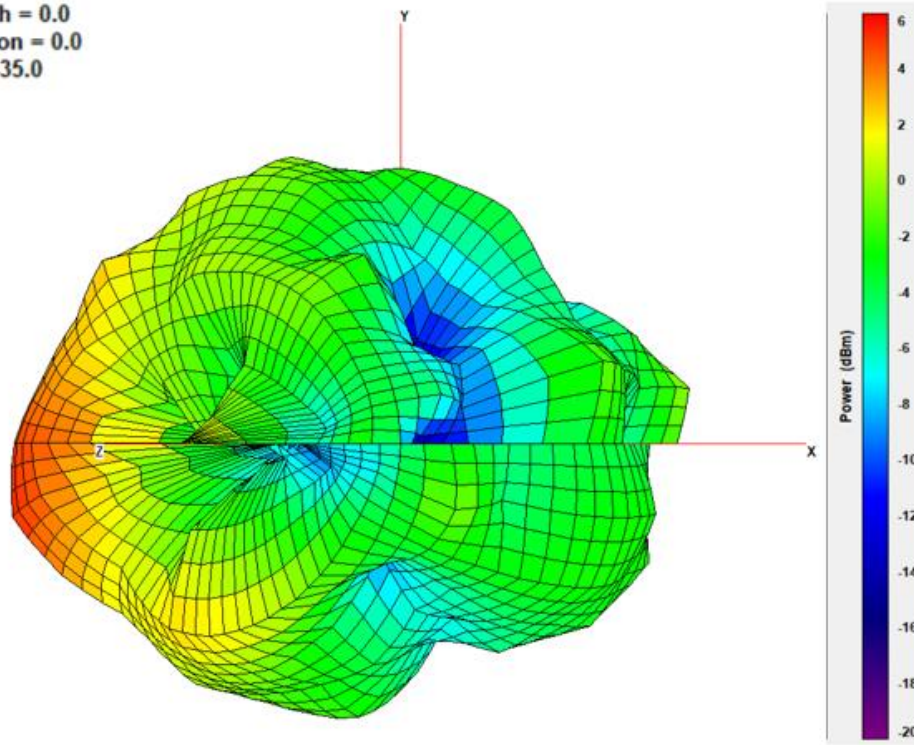

XY Plane

XZ Plane

YZ Plane

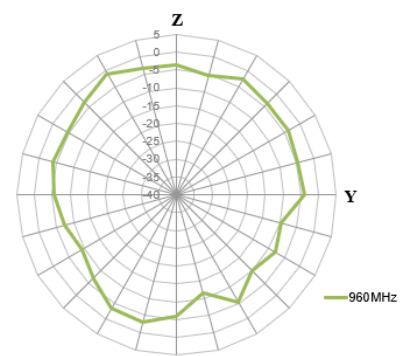
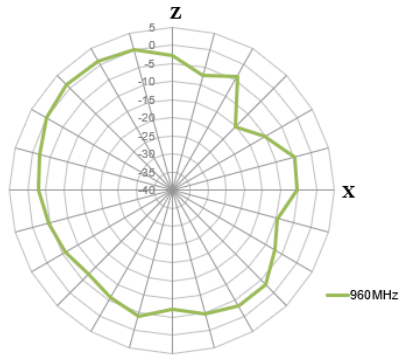
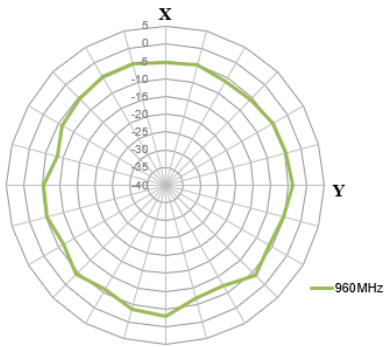

1710MHz

Azimuth = 0.0  
Elevation = 0.0  
Roll = -35.0

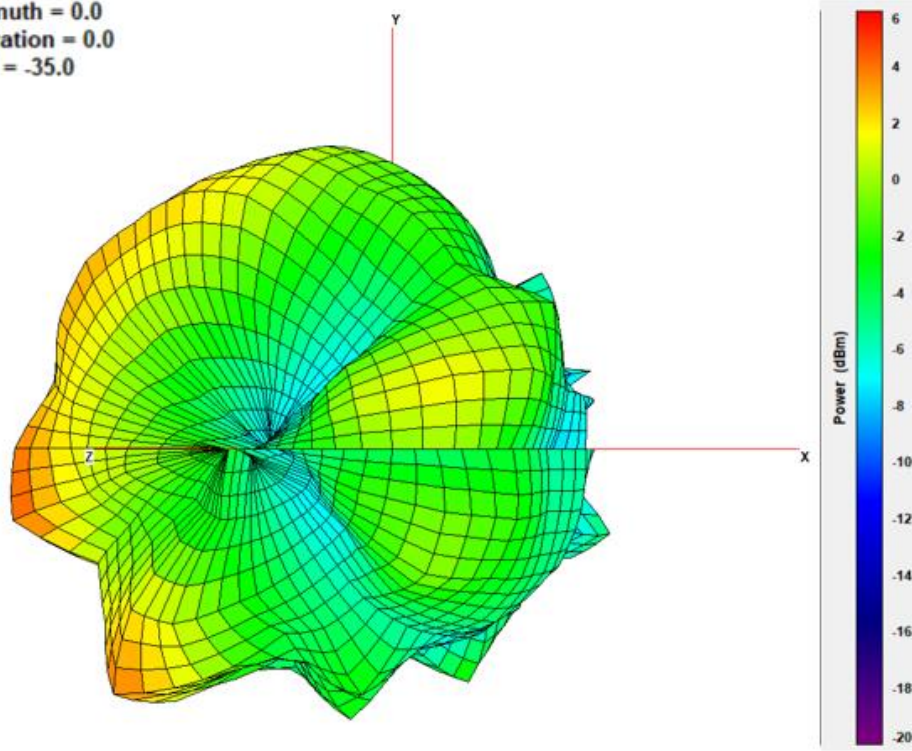

XY Plane

XZ Plane

YZ Plane

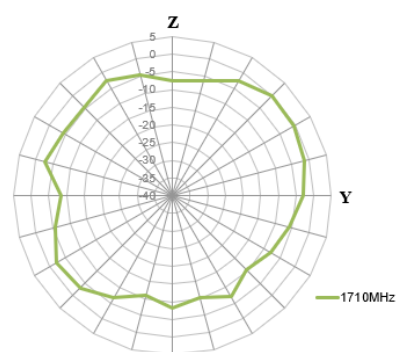
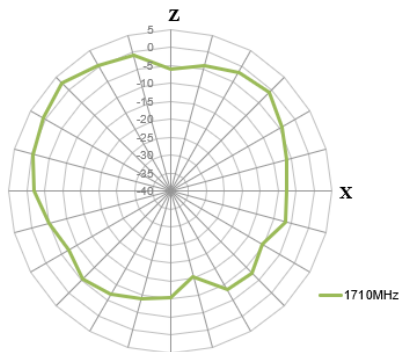
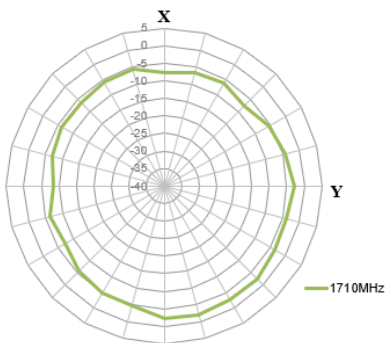



1880MHz

Azimuth = 0.0  
 Elevation = 0.0  
 Roll = -35.0

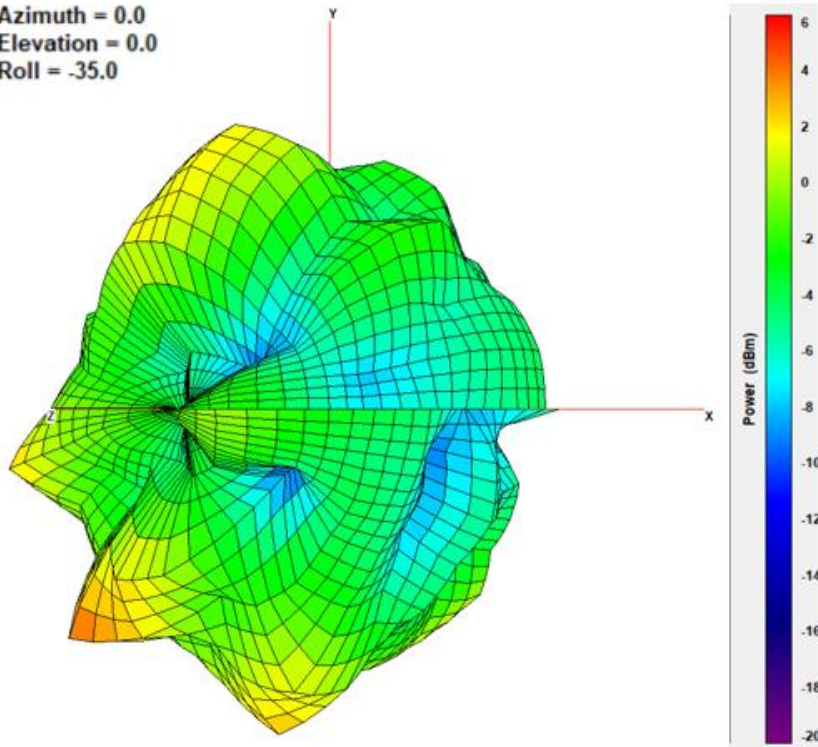

XY Plane

XZ Plane

YZ Plane

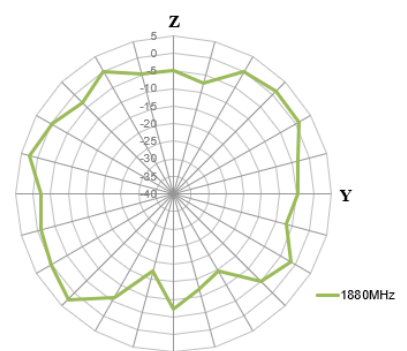
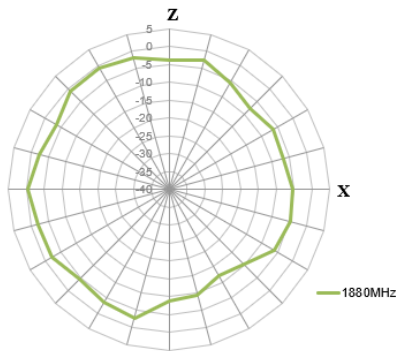
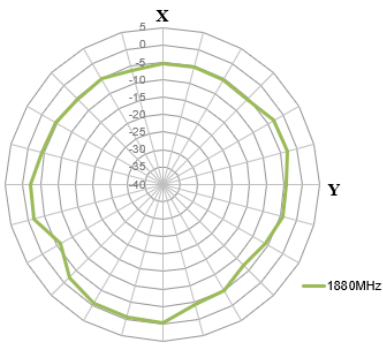

1990MHz

Azimuth = 0.0  
Elevation = 0.0  
Roll = -35.0

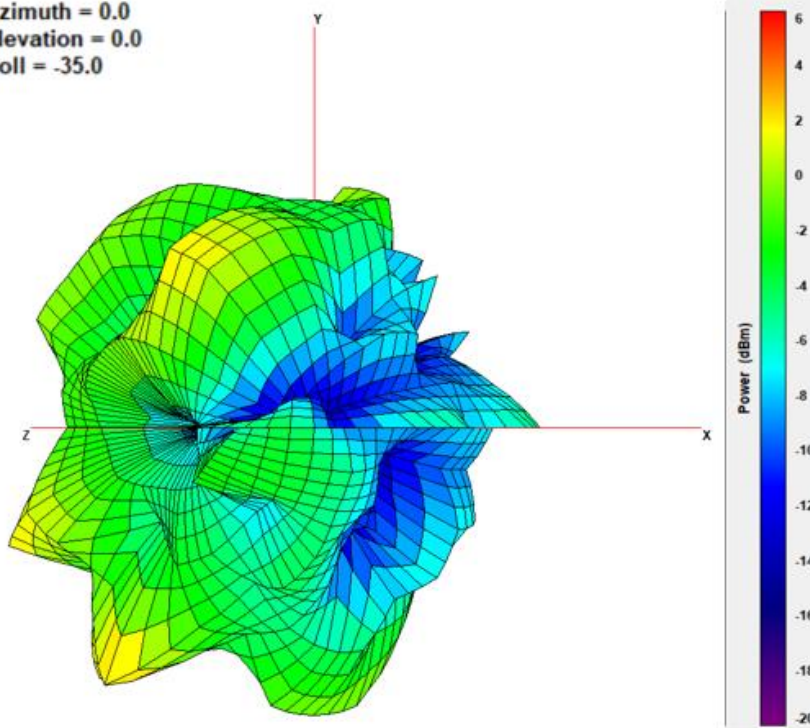

XY Plane

XZ Plane

YZ Plane

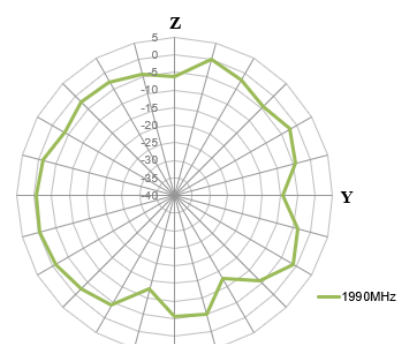
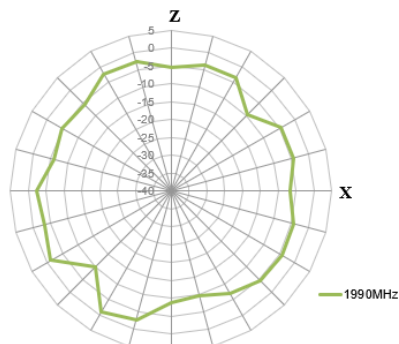
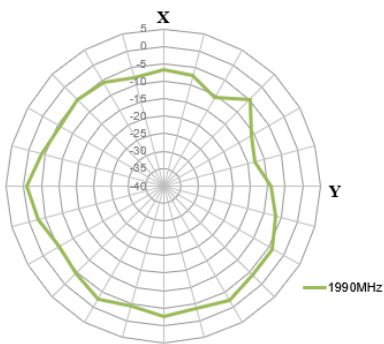

2170MHz

Azimuth = 0.0  
Elevation = 0.0  
Roll = -35.0

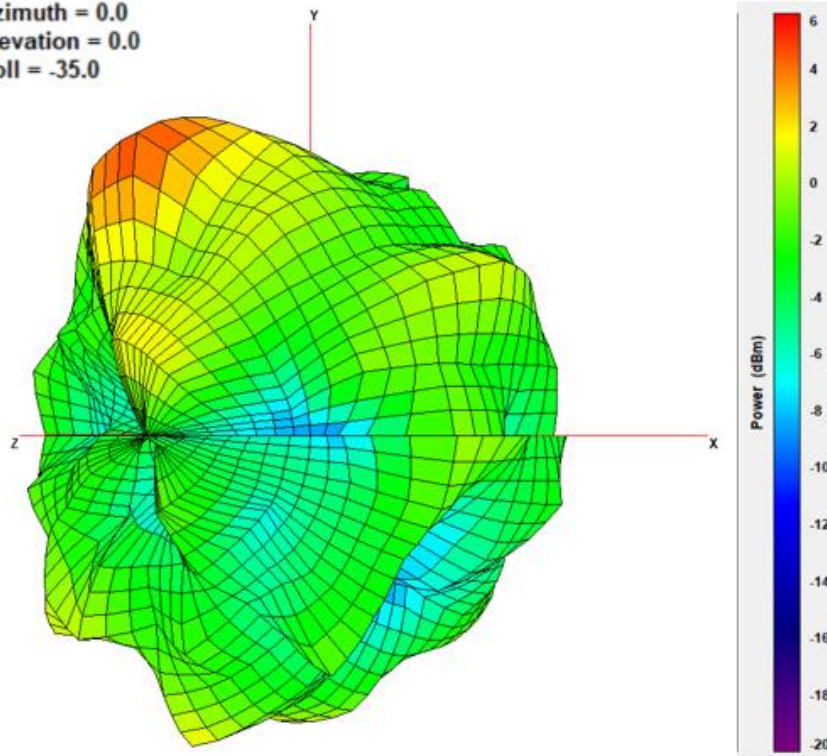

XY Plane

XZ Plane

YZ Plane

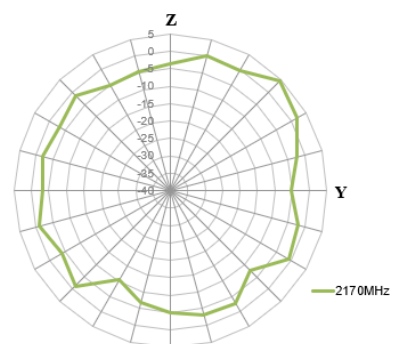
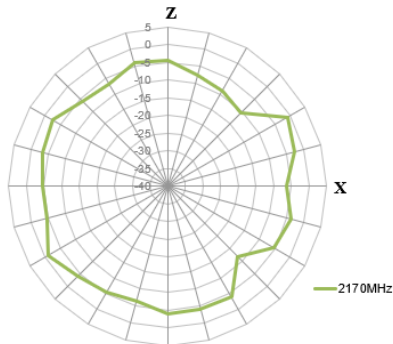
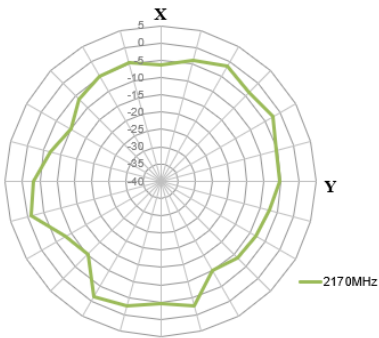

2300MHz

Azimuth = 0.0  
Elevation = 0.0  
Roll = -35.0

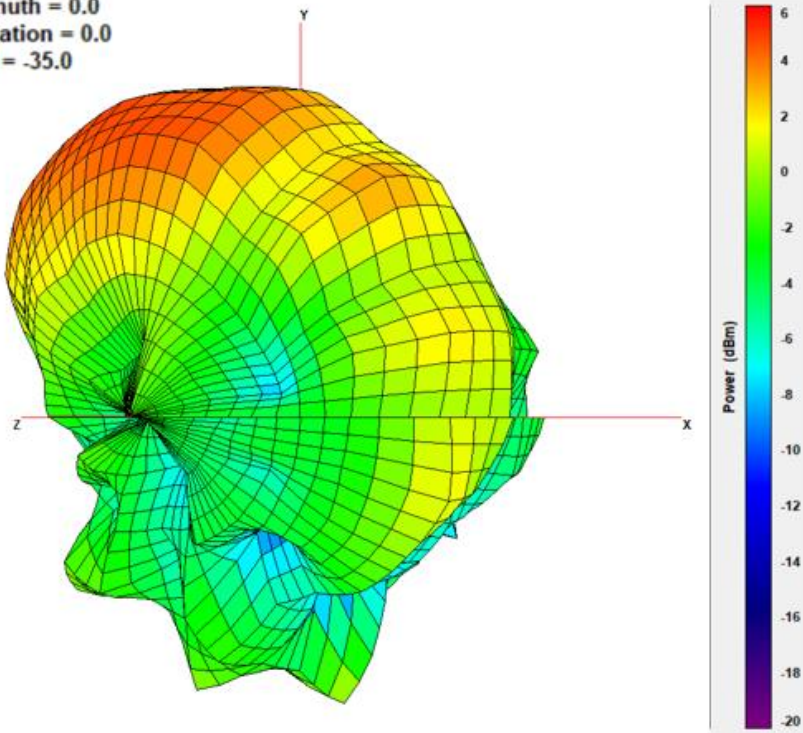

XY Plane

XZ Plane

YZ Plane

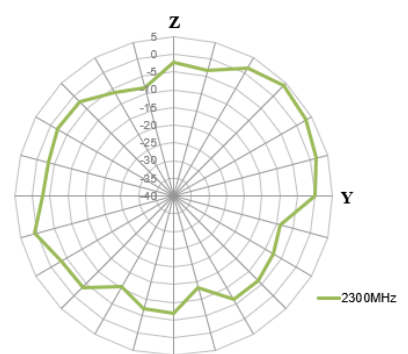
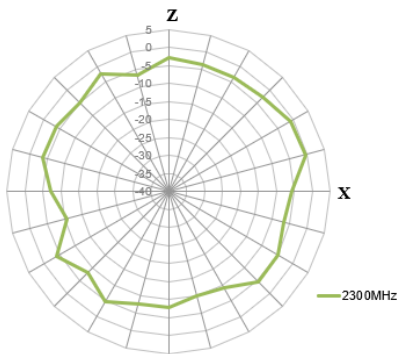
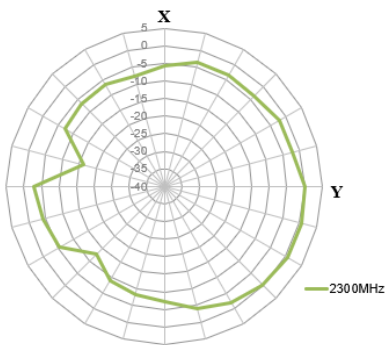

2500MHz

Azimuth = 0.0  
Elevation = 0.0  
Roll = -35.0

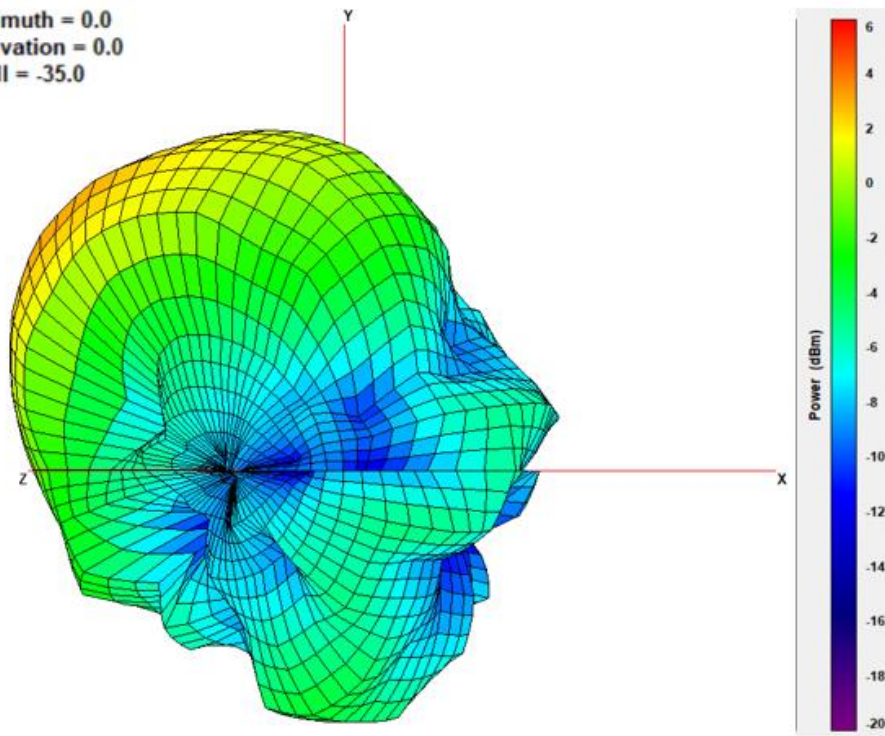

XY Plane

XZ Plane

YZ Plane

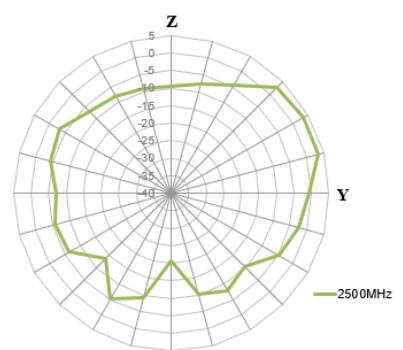
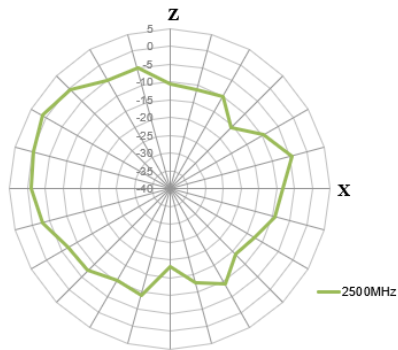
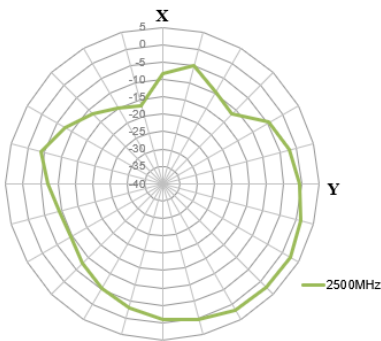

2700MHz

Azimuth = 0.0  
Elevation = 0.0  
Roll = -35.0

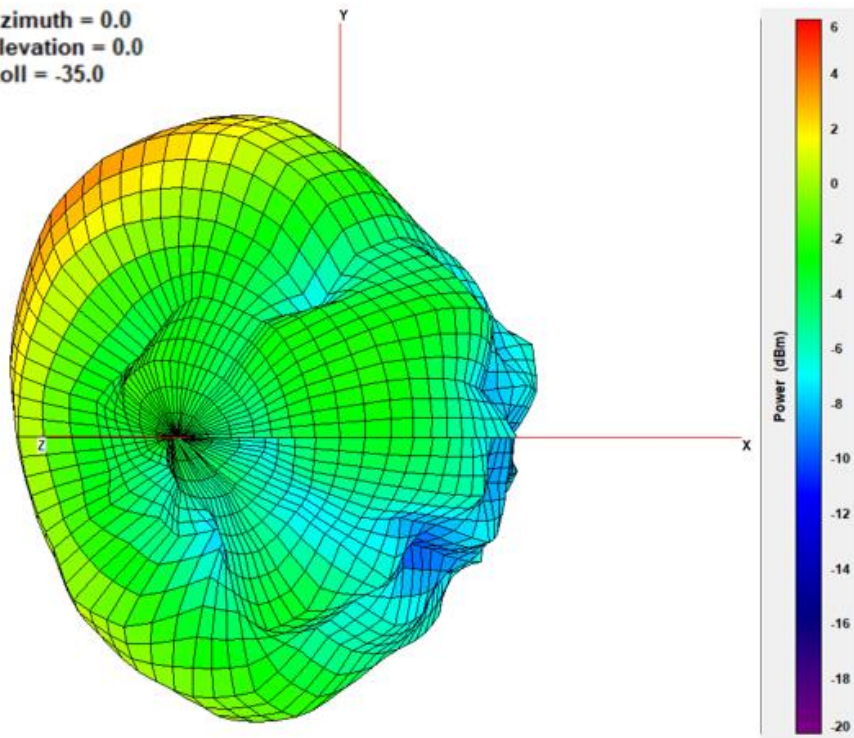

XY Plane

XZ Plane

YZ Plane

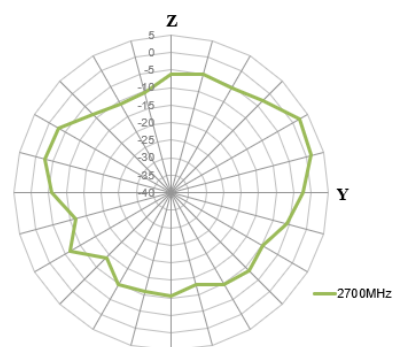
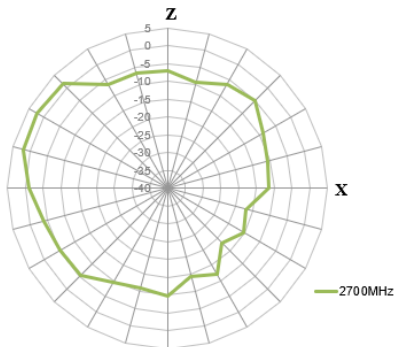
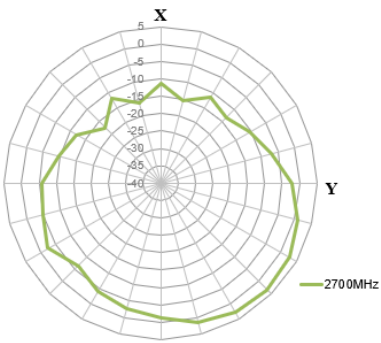

3200MHz

Azimuth = 0.0  
Elevation = 0.0  
Roll = -35.0

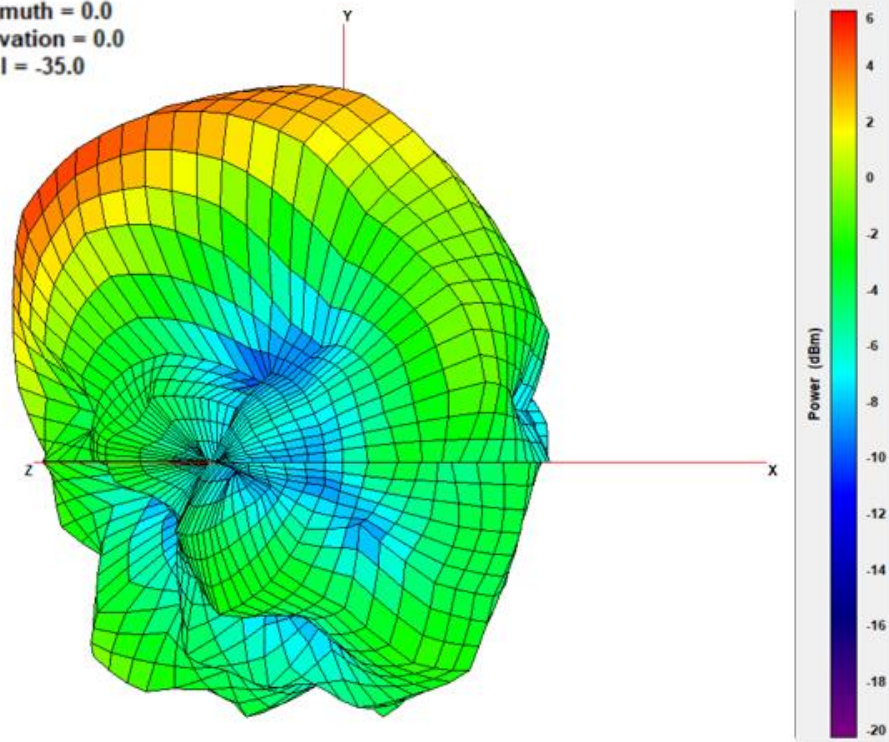

XY Plane

XZ Plane

YZ Plane

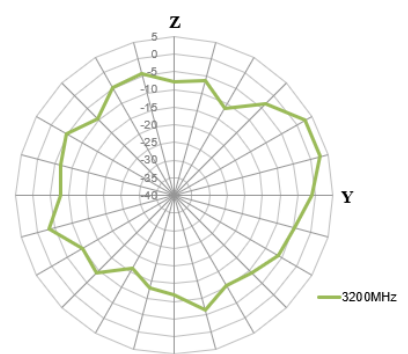
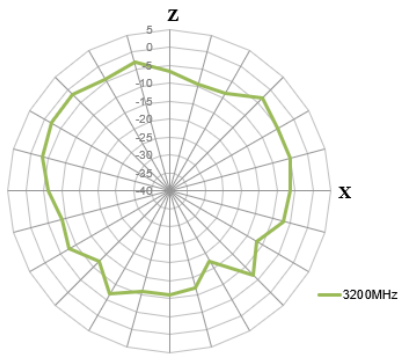
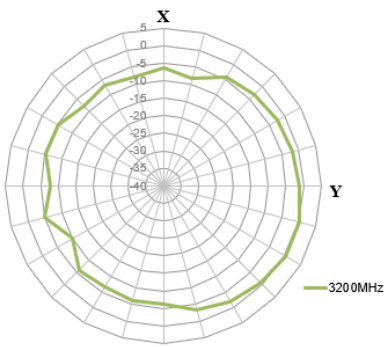

4200MHz

Azimuth = 0.0  
Elevation = 0.0  
Roll = -35.0

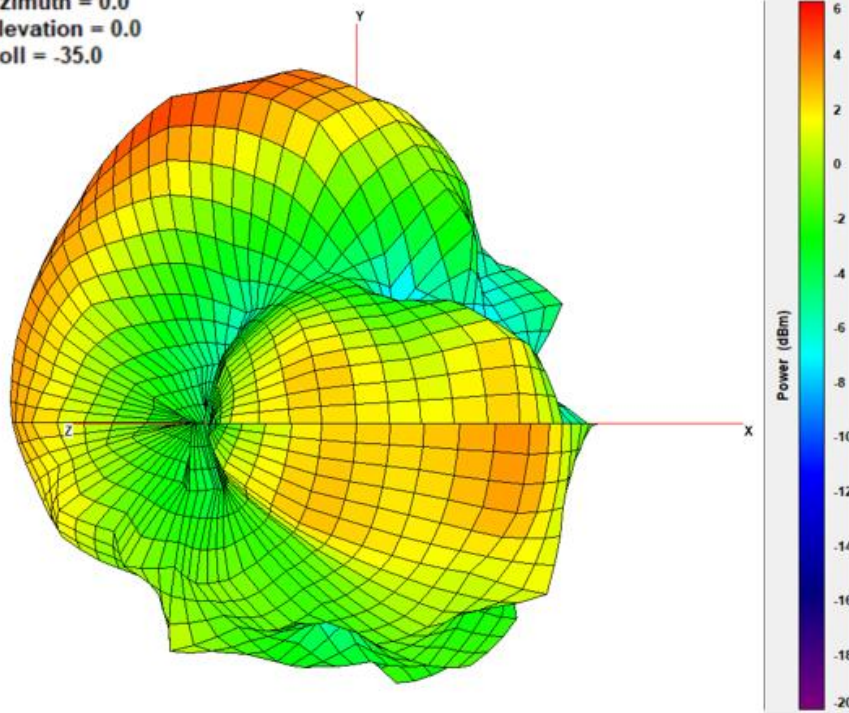

XY Plane

XZ Plane

YZ Plane

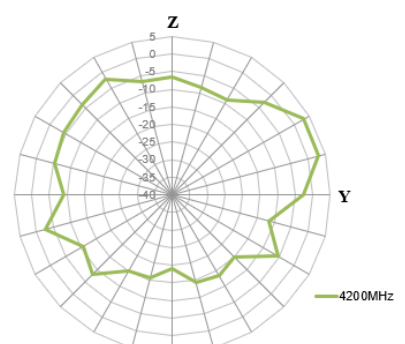
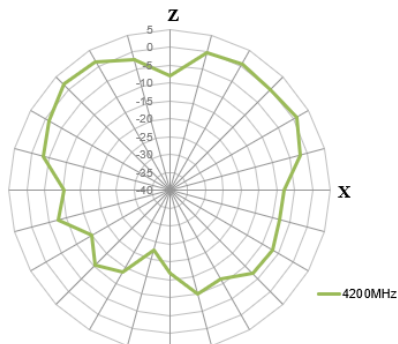
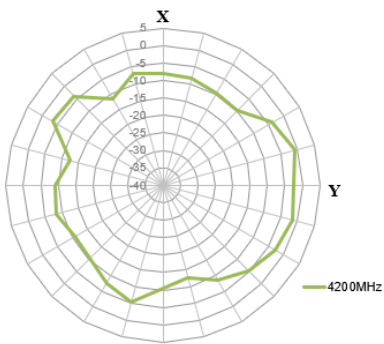



# 5150MHz

Azimuth = 0.0  
Elevation = 0.0  
Roll = -35.0

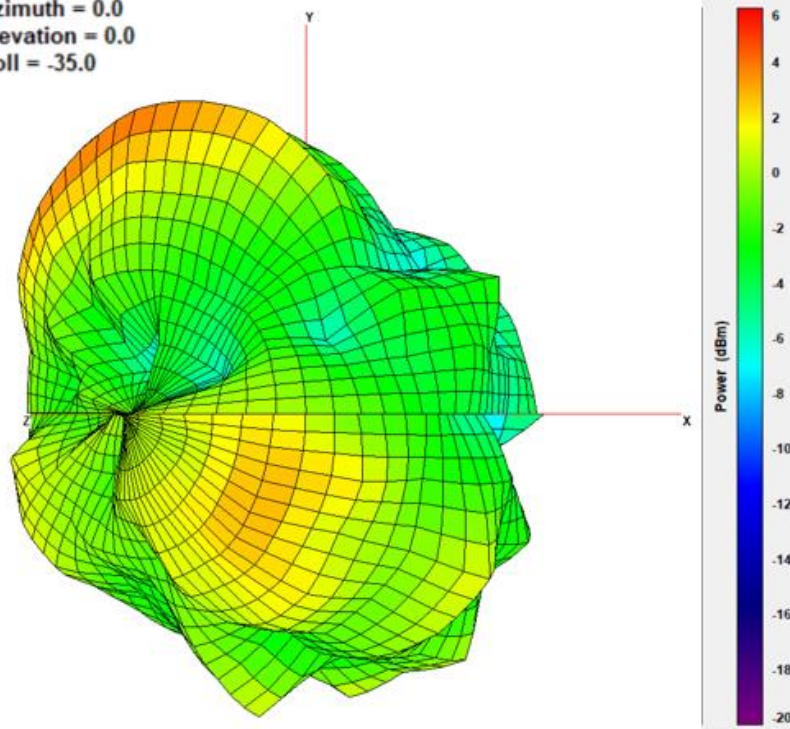

XY Plane

XZ Plane

YZ Plane

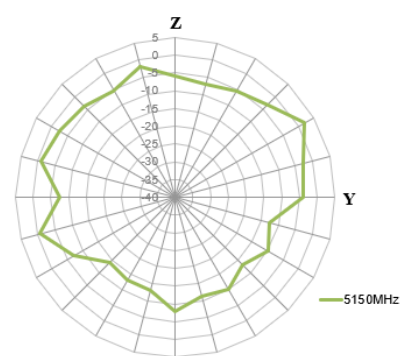
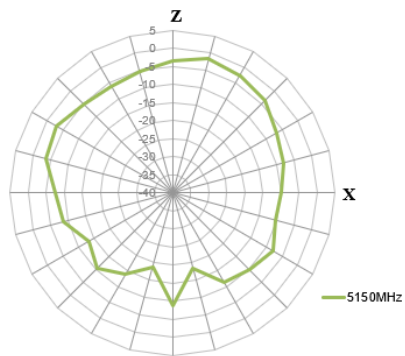
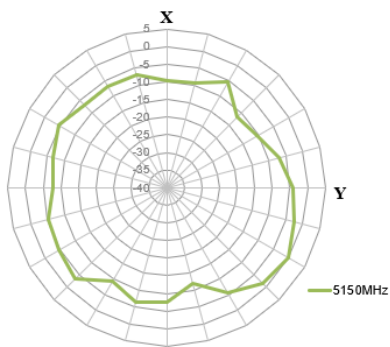

5550MHz

Azimuth = 0.0  
 Elevation = 0.0  
 Roll = -35.0

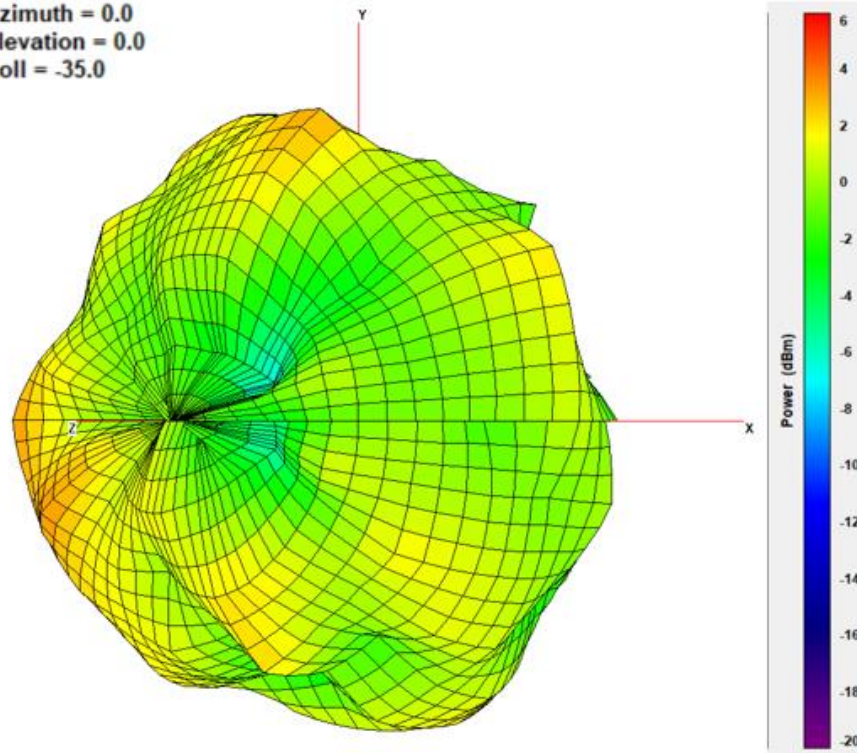

XY Plane

XZ Plane

YZ Plane

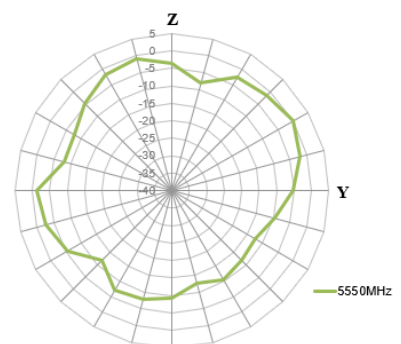
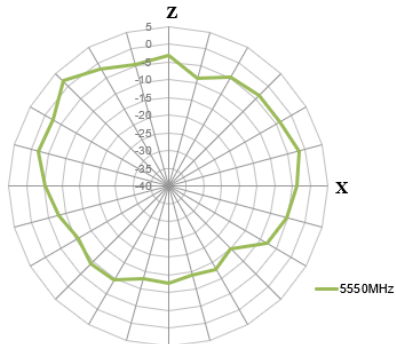
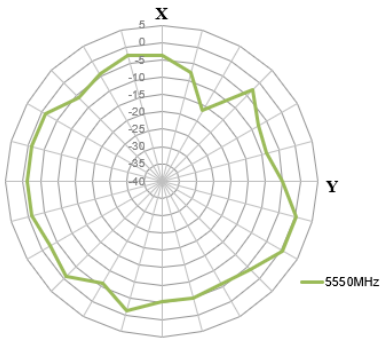

4.3 LTE2 – 705MHz 3D and 2D Radiation Patterns

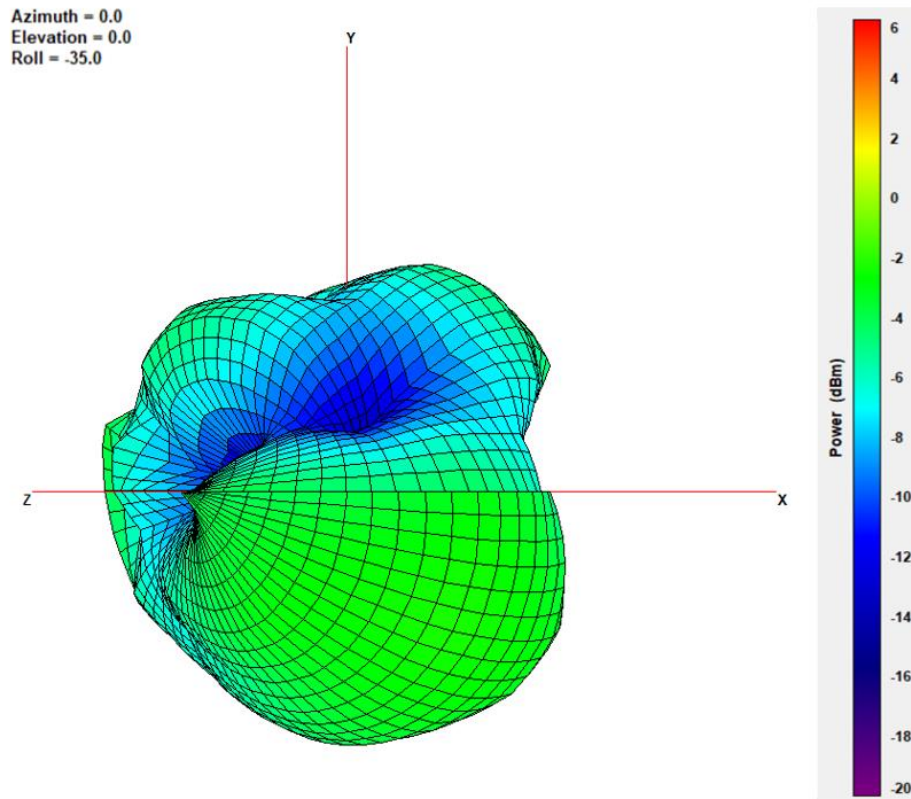

XY Plane

XZ Plane

YZ Plane

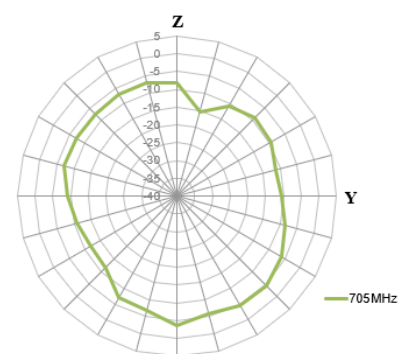
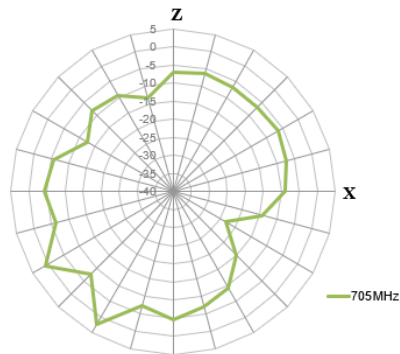
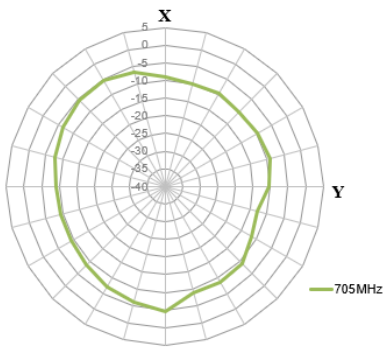

750MHz

Azimuth = 0.0  
Elevation = 0.0  
Roll = -35.0

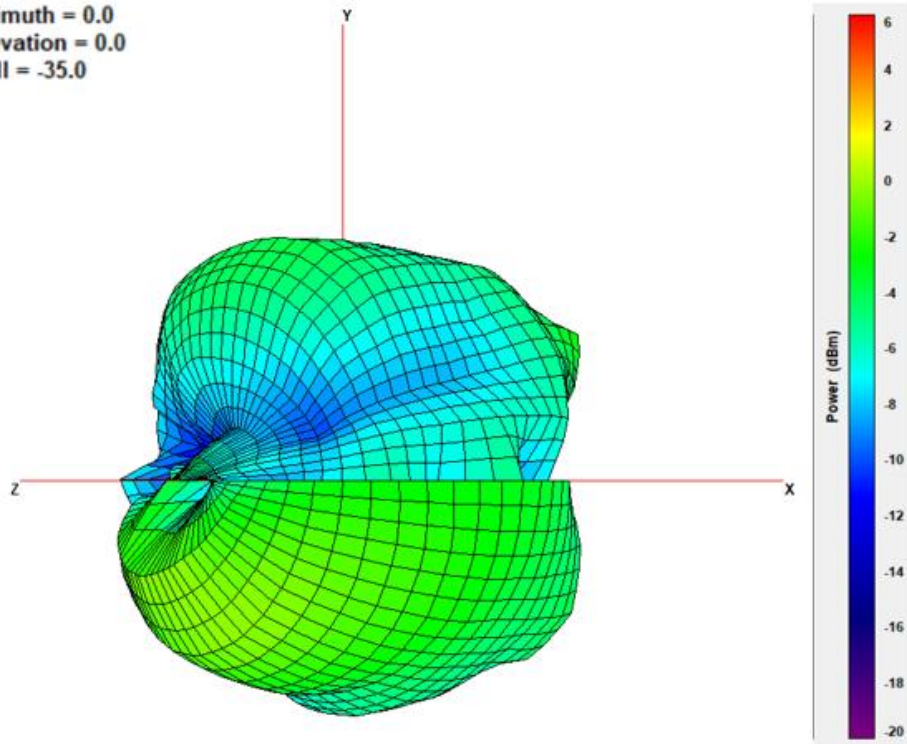

XY Plane

XZ Plane

YZ Plane

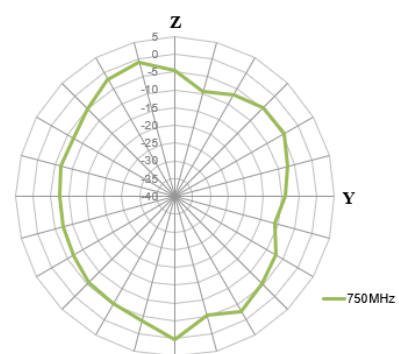
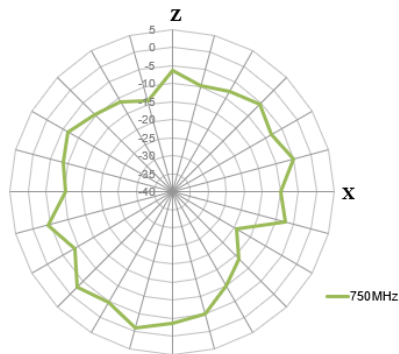
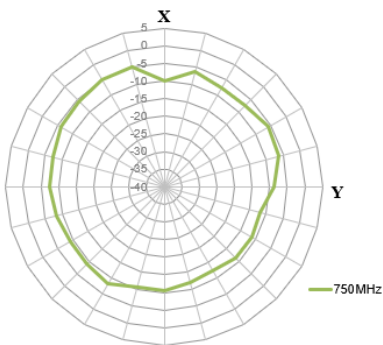

825MHz

Azimuth = 0.0  
Elevation = 0.0  
Roll = -35.0

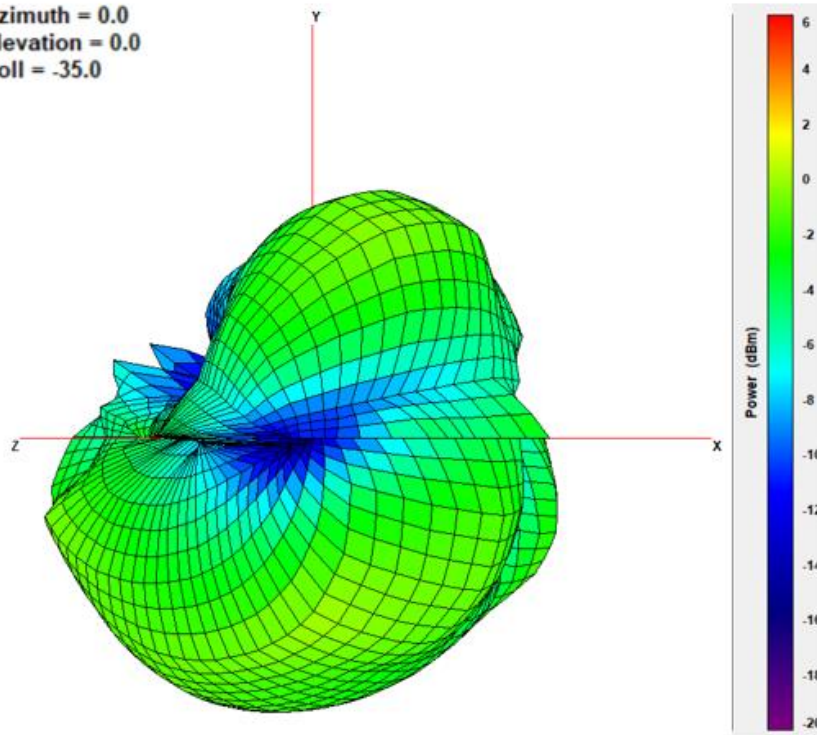

XY Plane

XZ Plane

YZ Plane

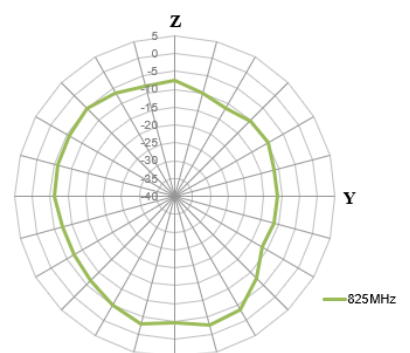
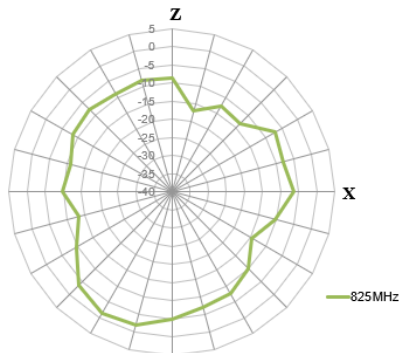
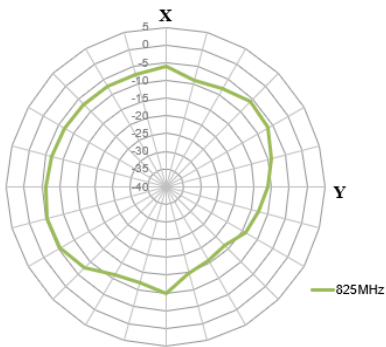

880MHz

Azimuth = 0.0  
Elevation = 0.0  
Roll = -35.0

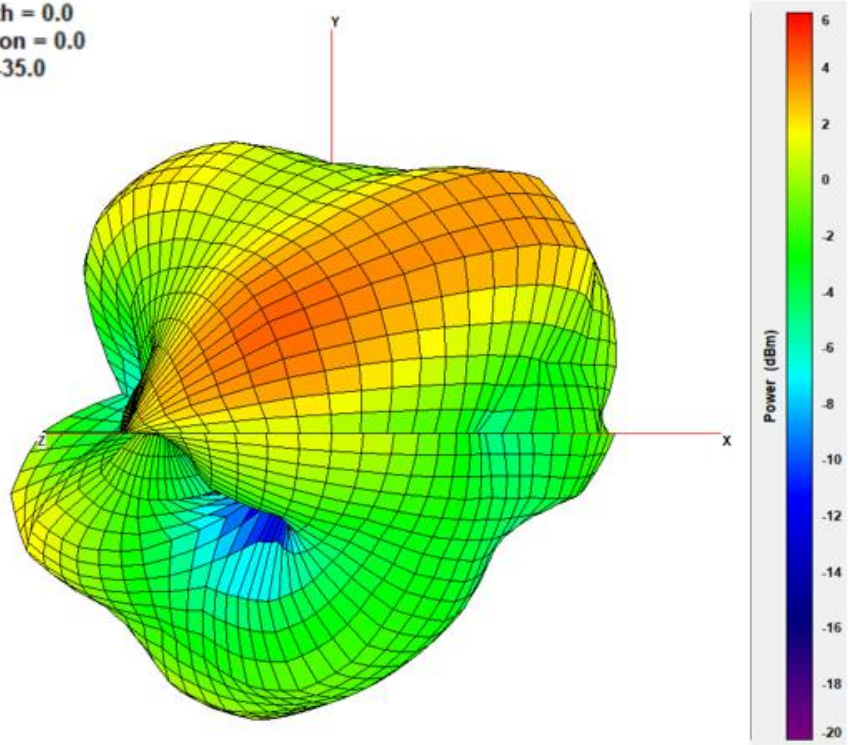

XY Plane

XZ Plane

YZ Plane

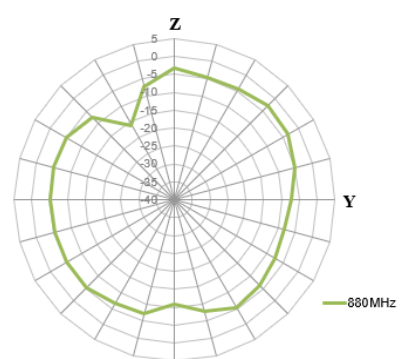
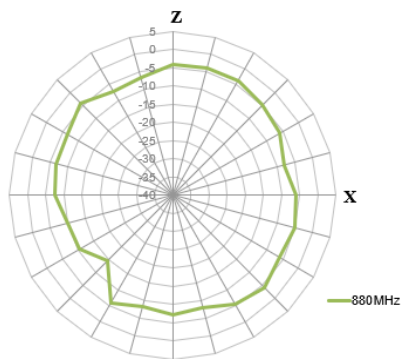
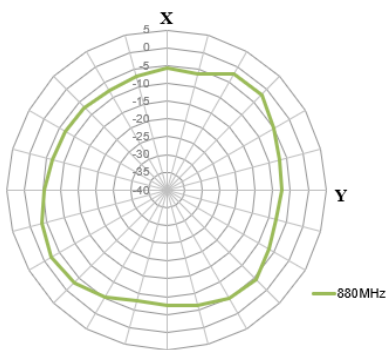

960MHz

Azimuth = 0.0  
Elevation = 0.0  
Roll = -35.0

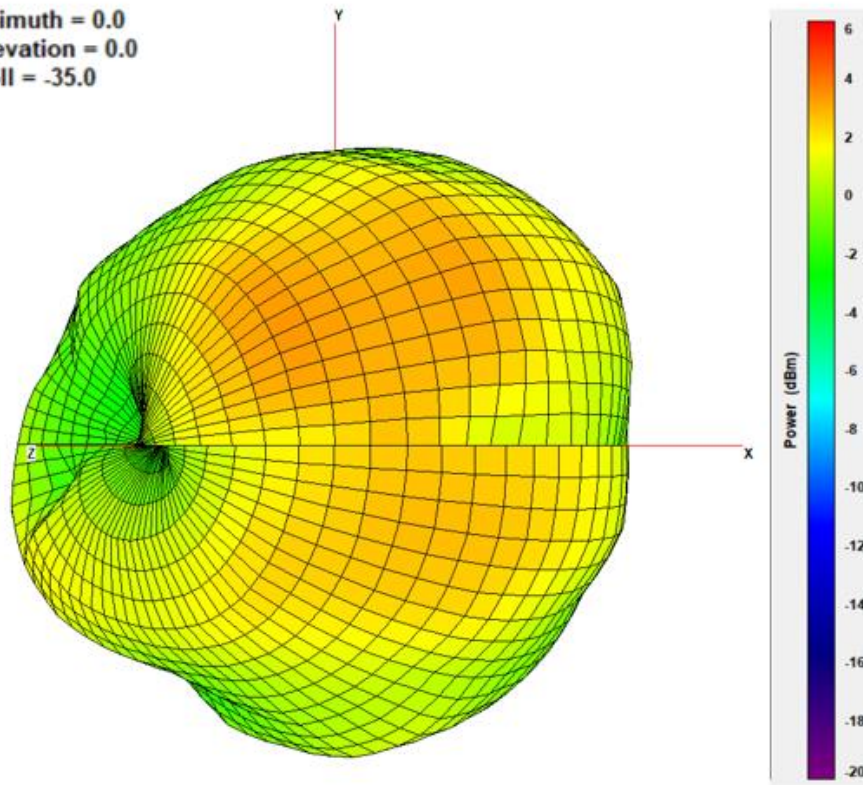

XY Plane

XZ Plane

YZ Plane

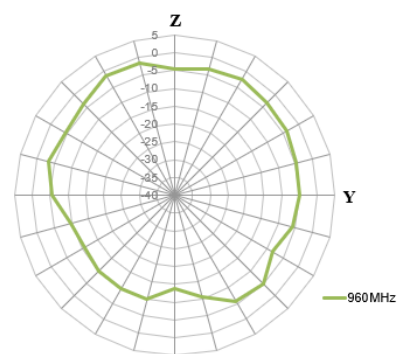
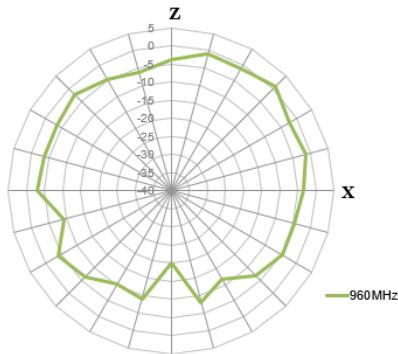
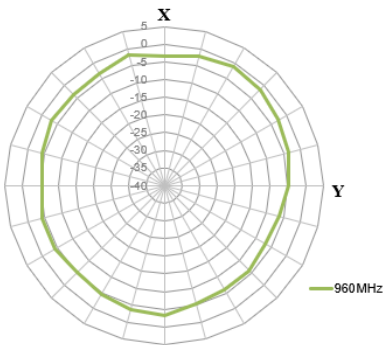

1710MHz

Azimuth = 0.0  
Elevation = 0.0  
Roll = -35.0

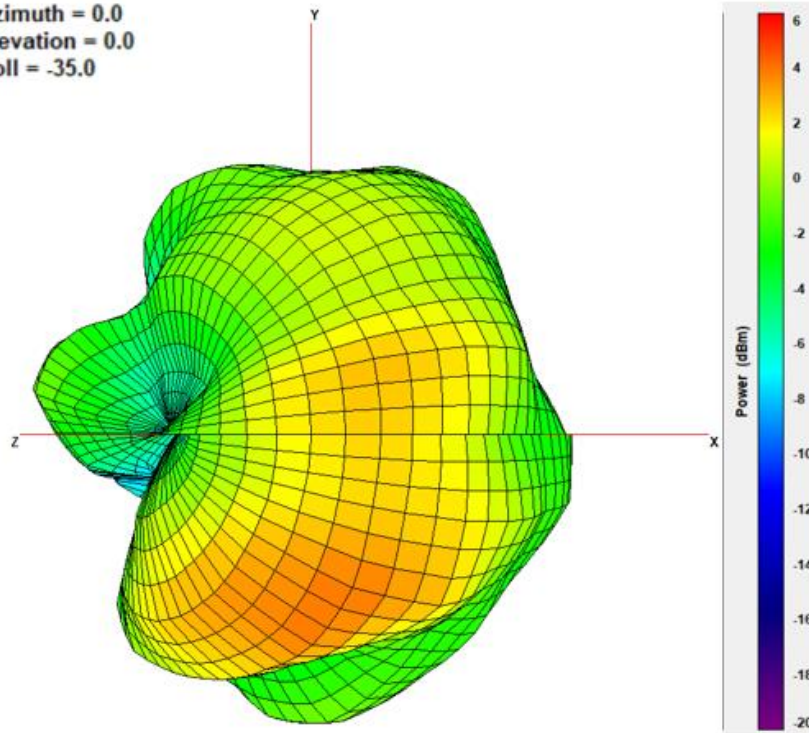

XY Plane

XZ Plane

YZ Plane

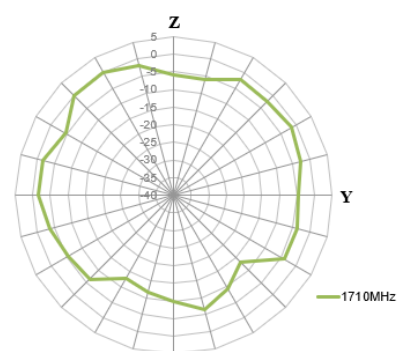
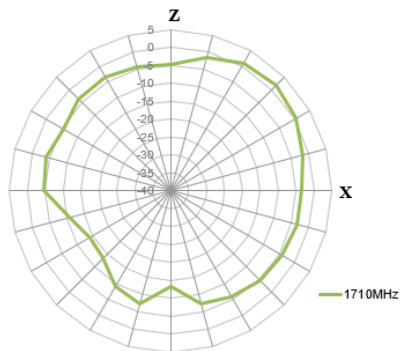
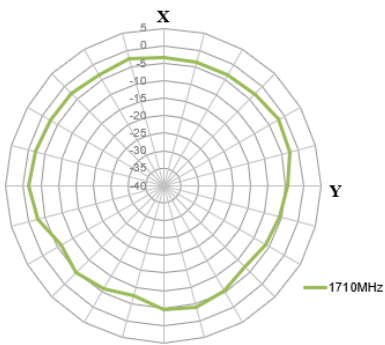



1880MHz

Azimuth = 0.0  
Elevation = 0.0  
Roll = -35.0

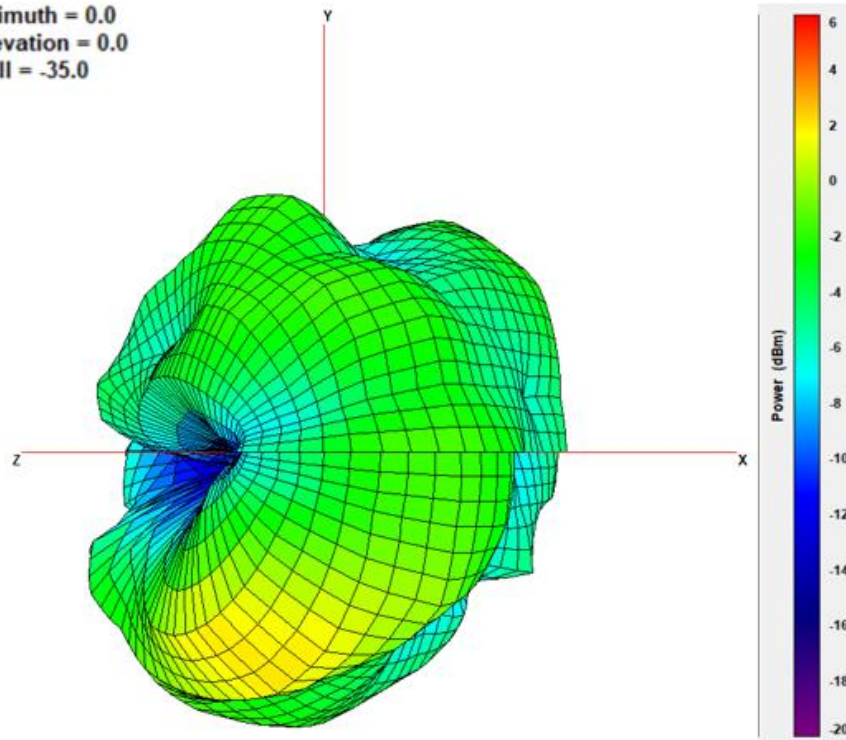

XY Plane

XZ Plane

YZ Plane

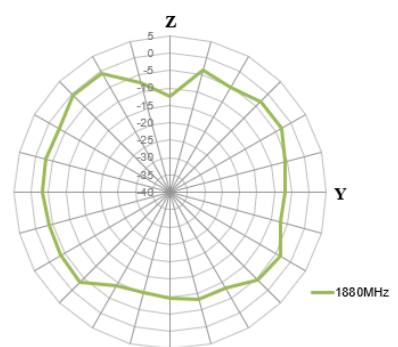
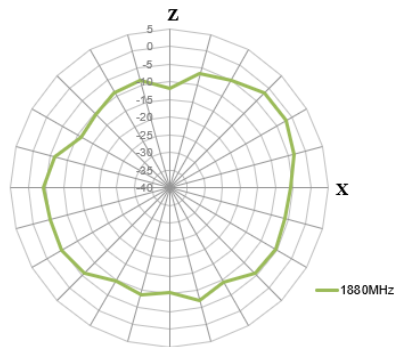
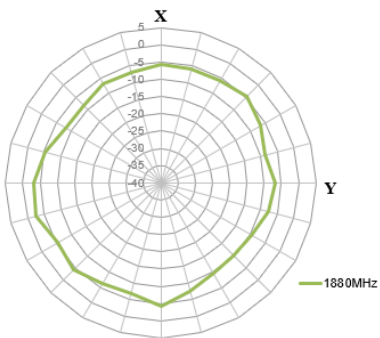

1990MHz

Azimuth = 0.0  
Elevation = 0.0  
Roll = -35.0

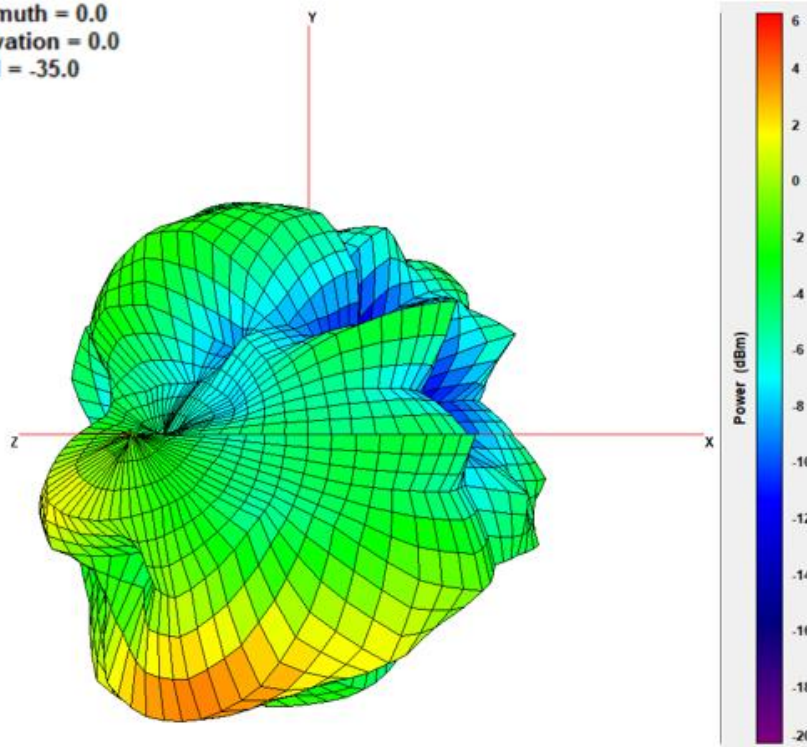

XY Plane

XZ Plane

YZ Plane

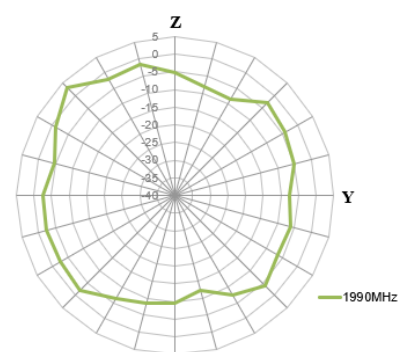
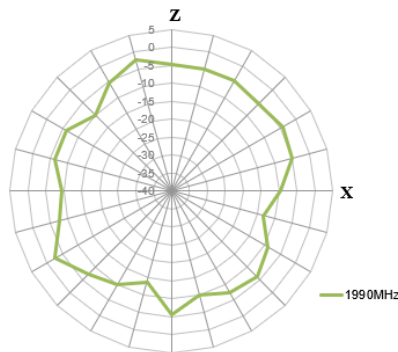
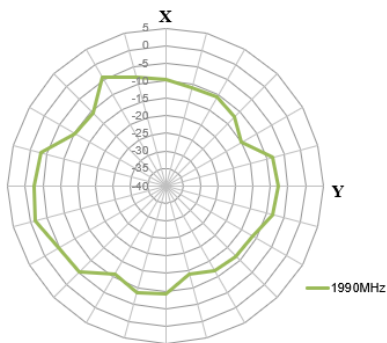

2170MHz

Azimuth = 0.0  
Elevation = 0.0  
Roll = -35.0

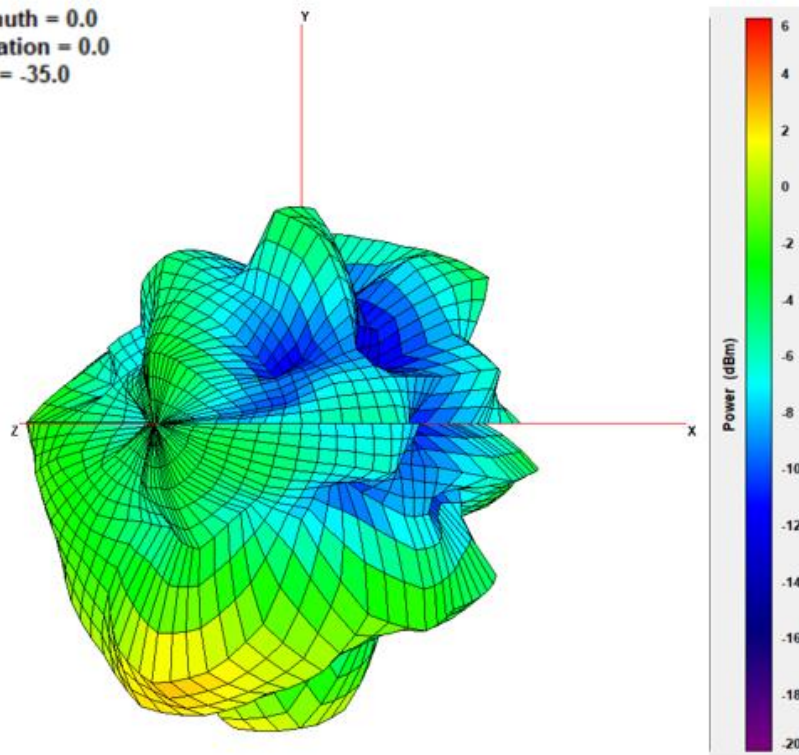

XY Plane

XZ Plane

YZ Plane

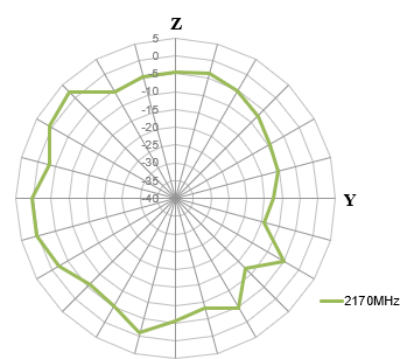
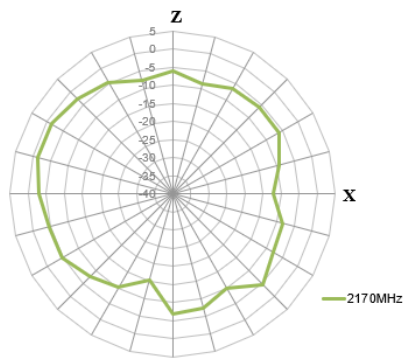
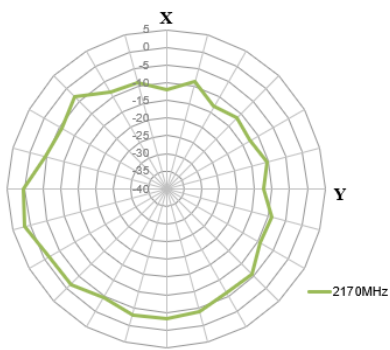

2300MHz

Azimuth = 0.0  
Elevation = 0.0  
Roll = -35.0

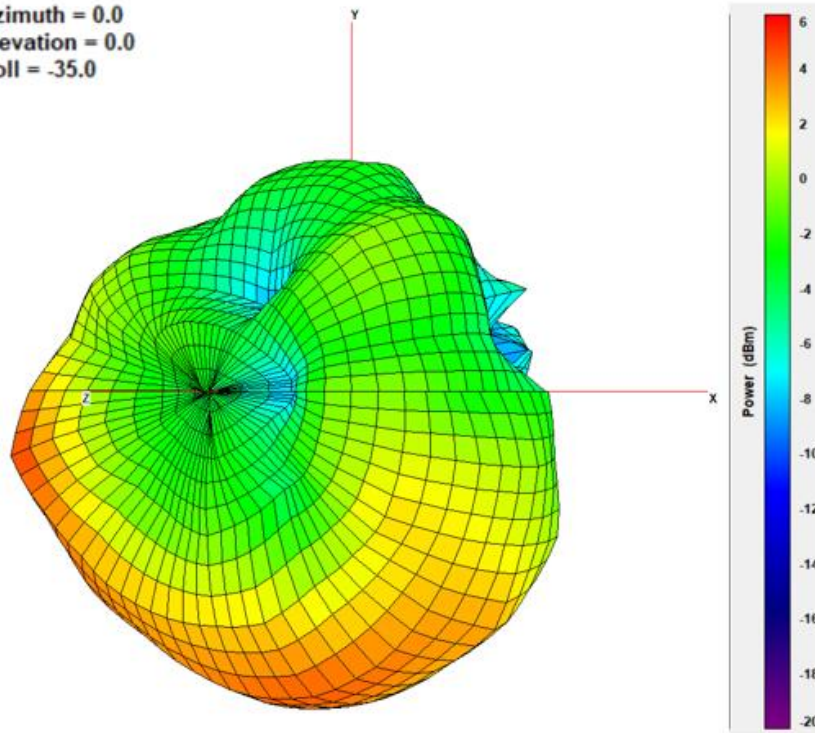

XY Plane

XZ Plane

YZ Plane

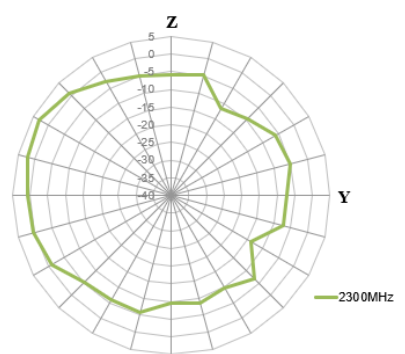
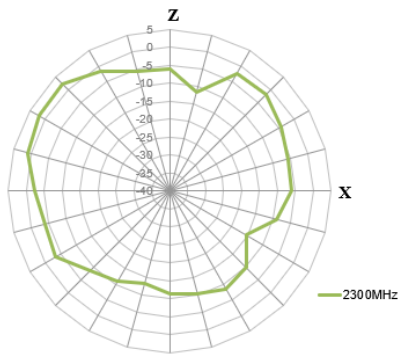
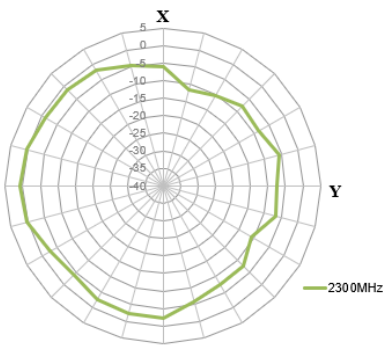

2500MHz

Azimuth = 0.0  
Elevation = 0.0  
Roll = -35.0

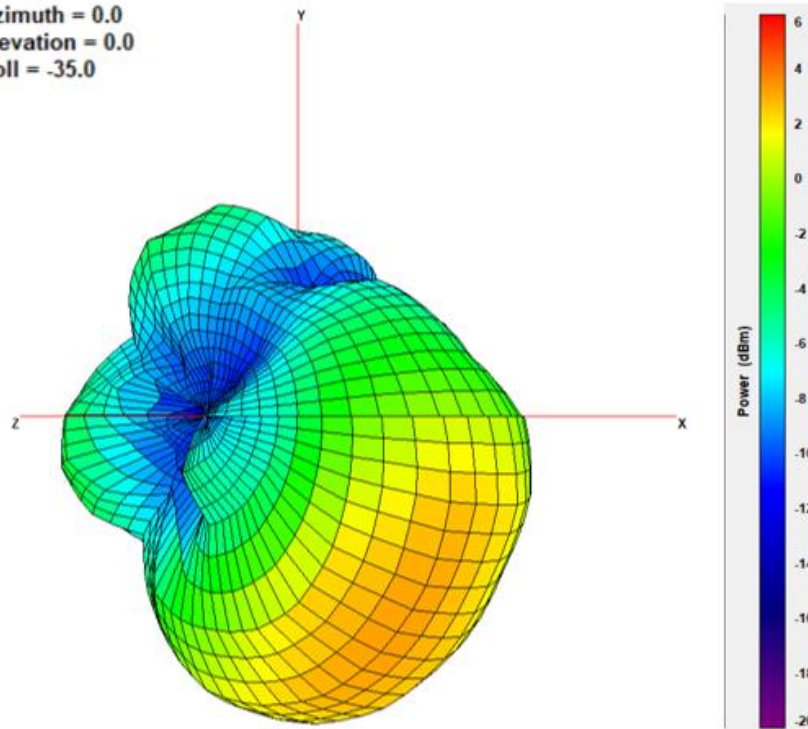

XY Plane

XZ Plane

YZ Plane

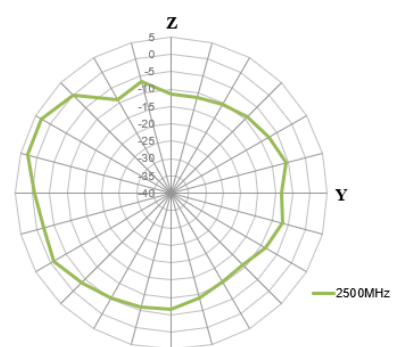
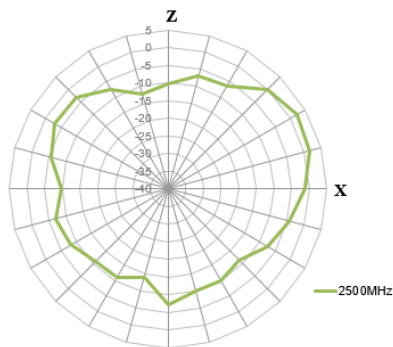
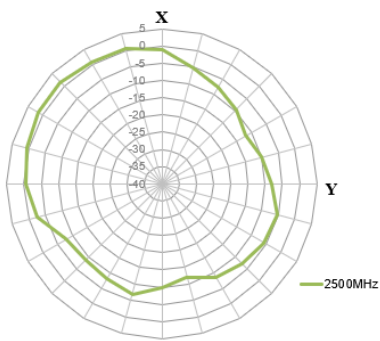

2700MHz

Azimuth = 0.0  
Elevation = 0.0  
Roll = -35.0

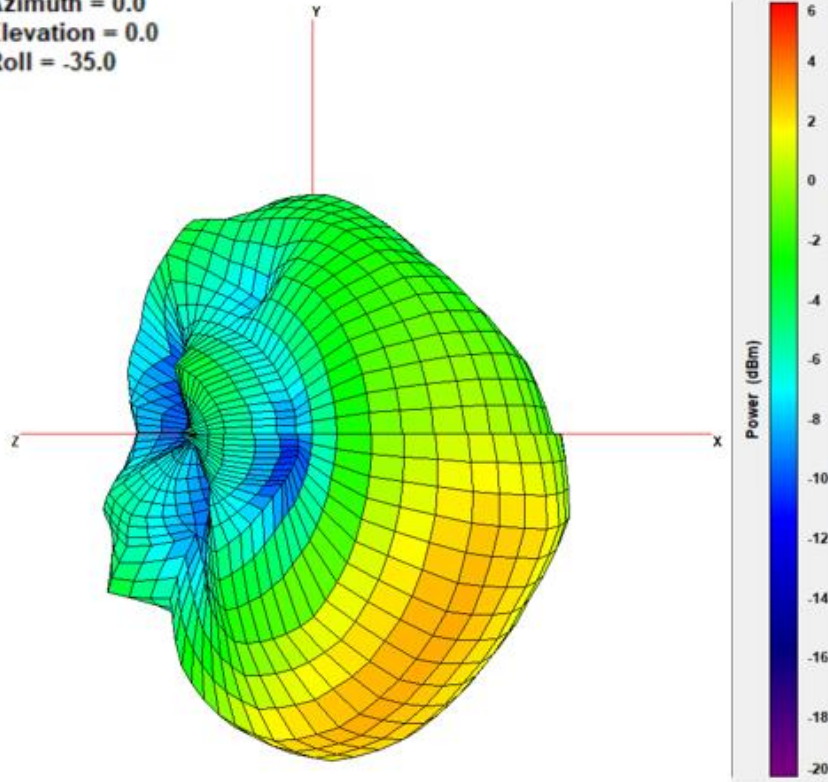

XY Plane

XZ Plane

YZ Plane

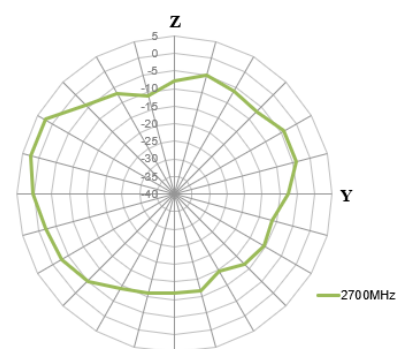
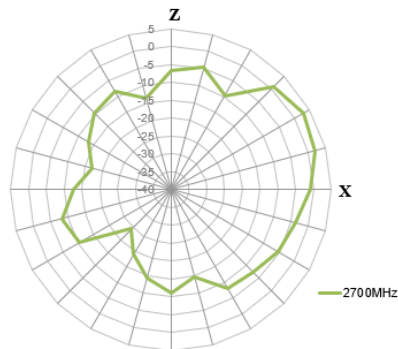
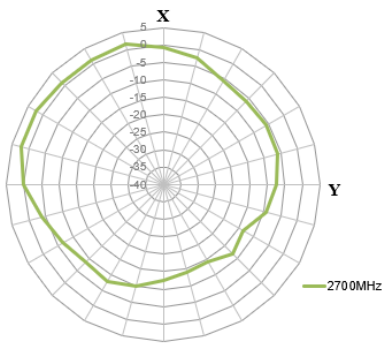

3200MHz

Azimuth = 0.0  
Elevation = 0.0  
Roll = -35.0

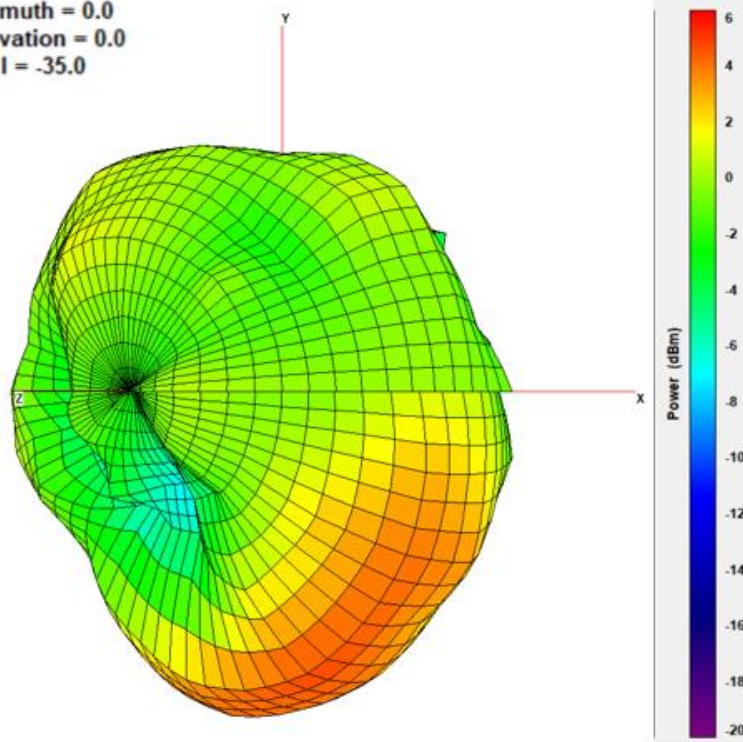

XY Plane

XZ Plane

YZ Plane

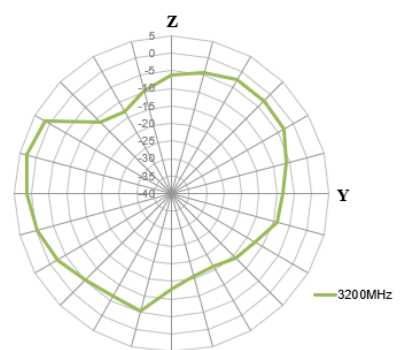
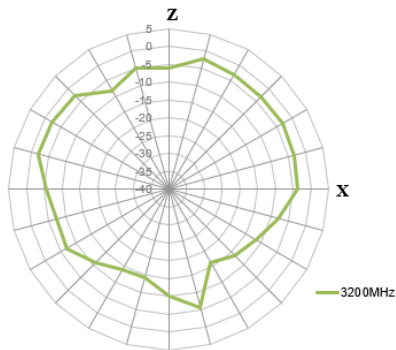
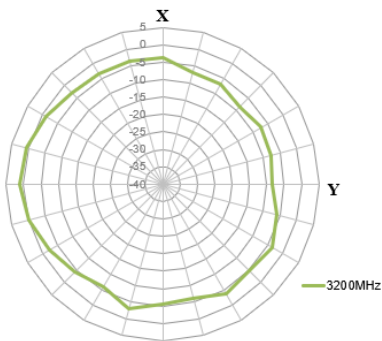

4200MHz

Azimuth = 0.0  
Elevation = 0.0  
Roll = -35.0

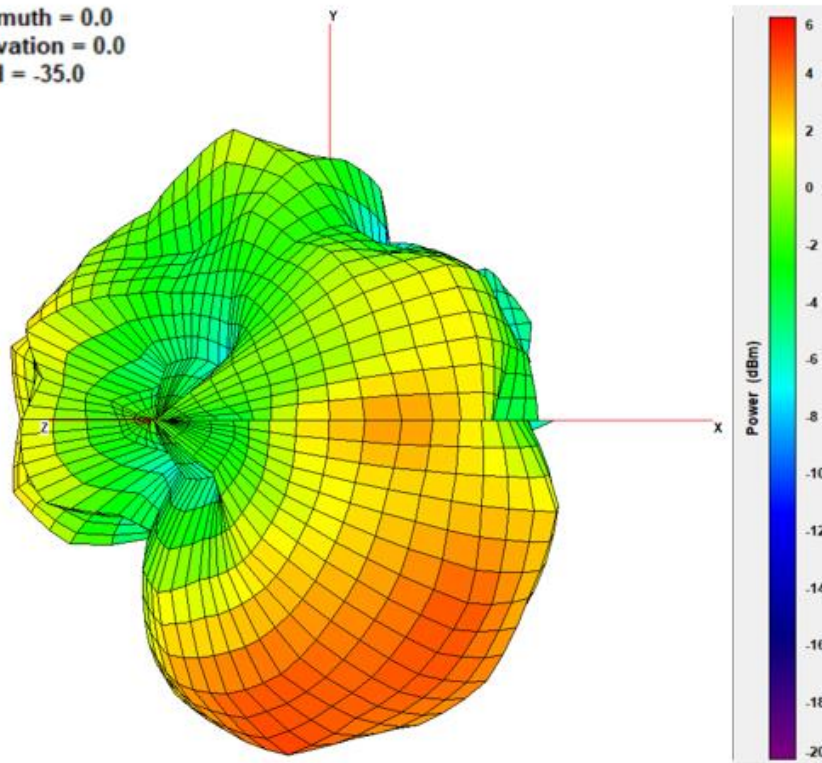

XY Plane

XZ Plane

YZ Plane

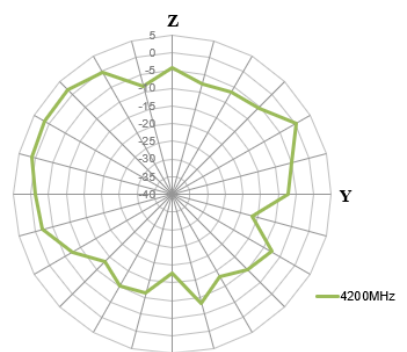
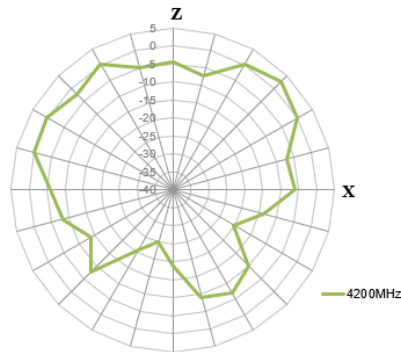
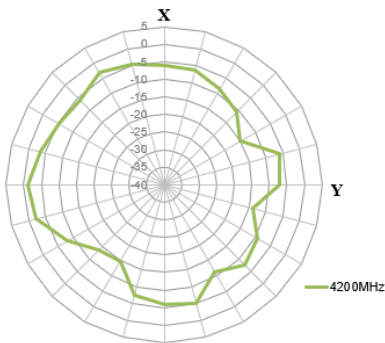



5150MHz

Azimuth = 0.0  
Elevation = 0.0  
Roll = -35.0

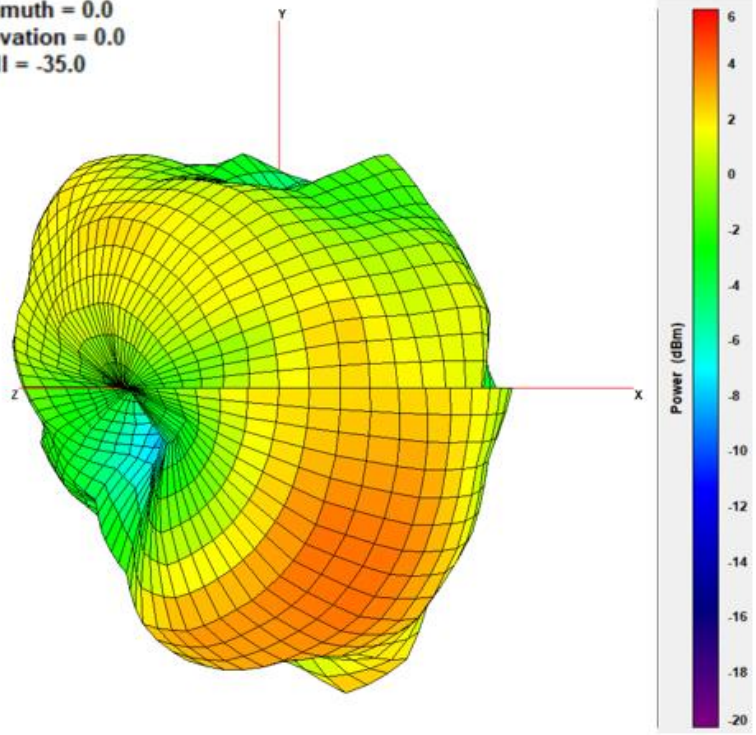

XY Plane

XZ Plane

YZ Plane

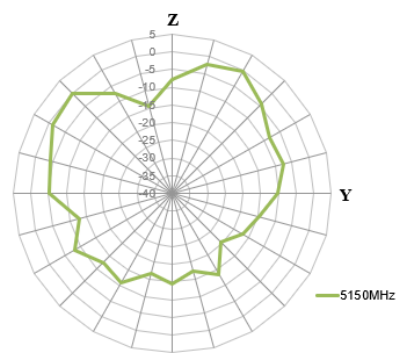
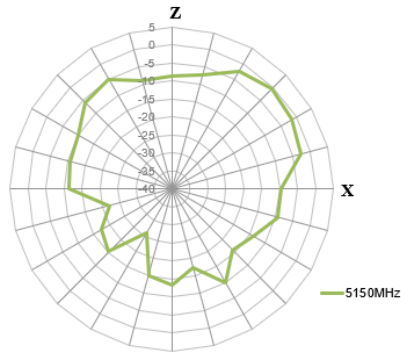
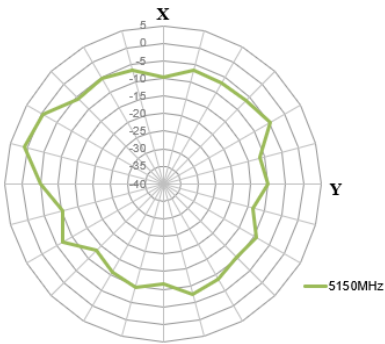

5550MHz

Azimuth = 0.0  
 Elevation = 0.0  
 Roll = -35.0

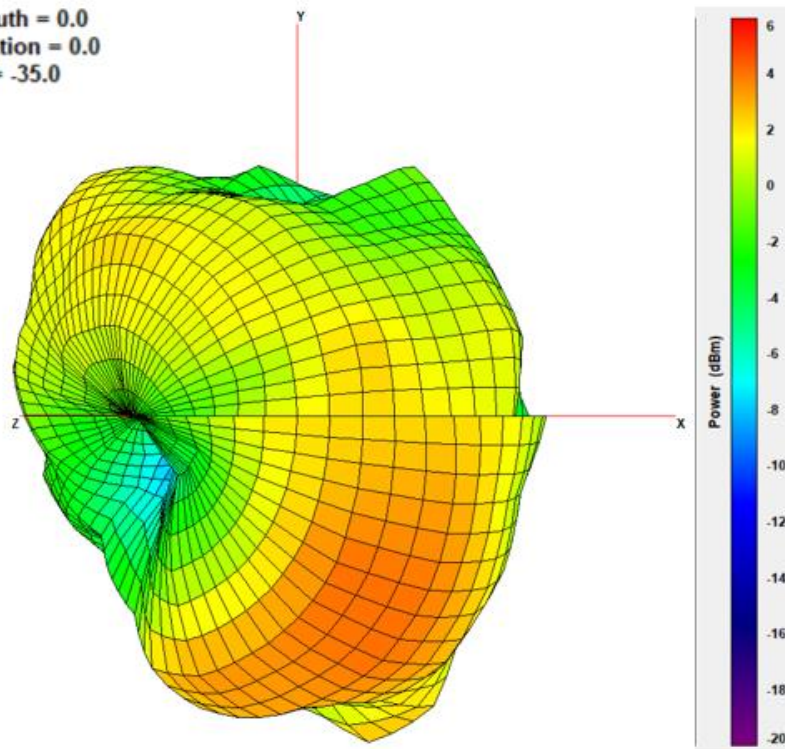

XY Plane

XZ Plane

YZ Plane

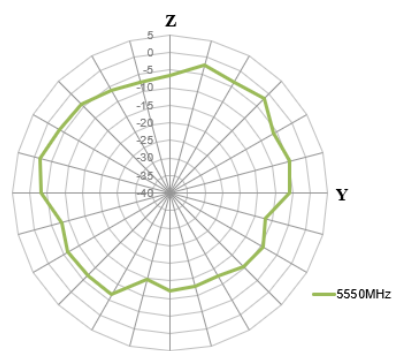
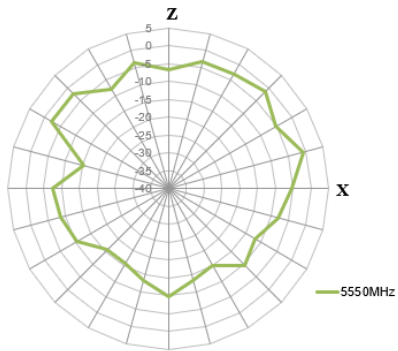
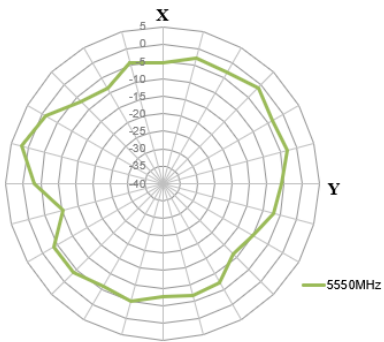

# 5. Mechanical Drawing (Units: mm)

Top View

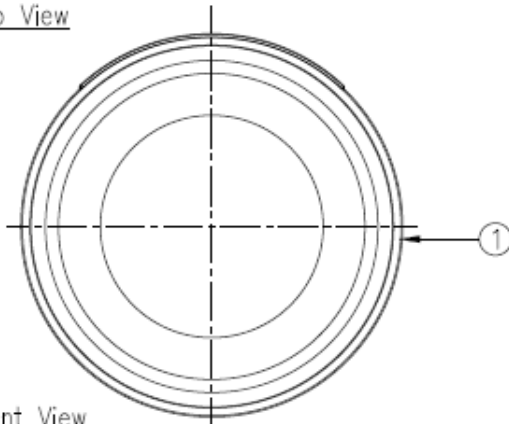

Front View

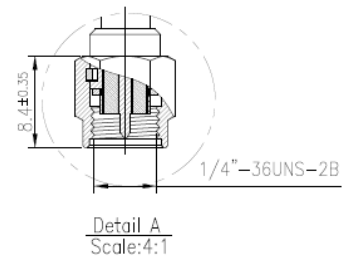
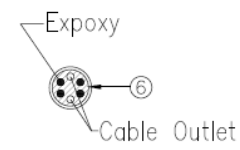
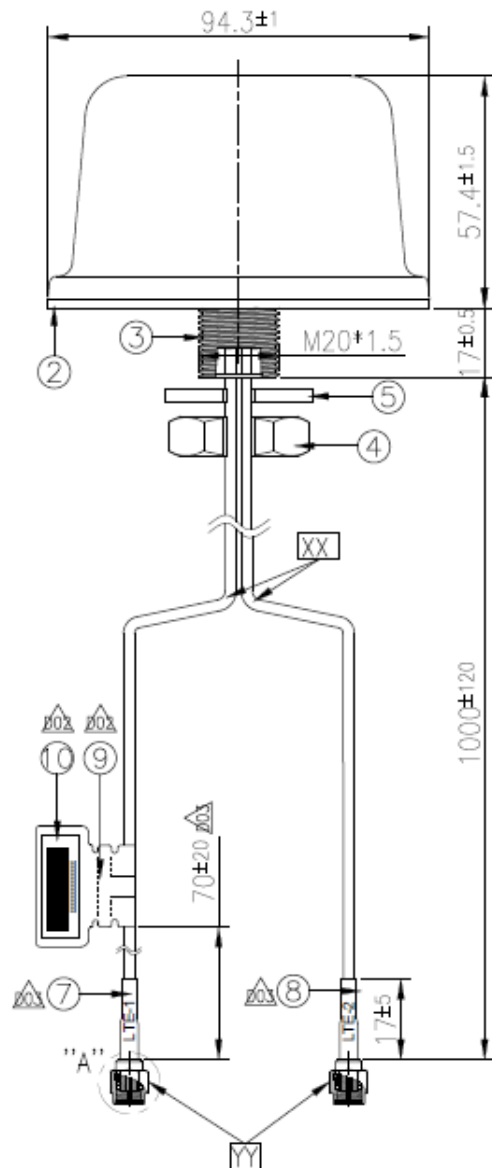

Name	P/N	Material	Finish	QTY
1 Mini ST Short Case	000114K000092A	ASA	Black	1
2 Adhese Foam Mini ST(Adl Foam)	001015C020000A	3M94484CR 4305	White Liner $\phi 0.3$	1
3 Mini ST Base	000314K000092A	Zinc Alloy	Ni Plated	1
4 Nut_M20x1.5Px10H_Cut	000413E030061A	Steel Carbon	Zn-Ni Plated $\phi 0.3$	1
5 Washer_Cut	000413E040061A	Steel Carbon	Zn-Ni Plated $\phi 0.3$	1
6 Cable Rubber	000713K000064A	Silicone	Black	1
7 Heat Shrink Tube (LTE-1)	001316C040000A	PE	Red Tube/White Text	1
8 Heat Shrink Tube (LTE-2)	001316C050000A	PE	Red Tube/White Text	1
9 Empty Label	001015G000000A	PEPA	White	1
10 Barcode Label	001015G010000A	PET	White	1

Name	P/N	Material	Finish	QTY
XX Cable Type	301615C000000A	RC316	Brown	2
YY Connector Type	200212G000013A	SMA(M)/ST	Au Plated	2

## 6. Installation Guide

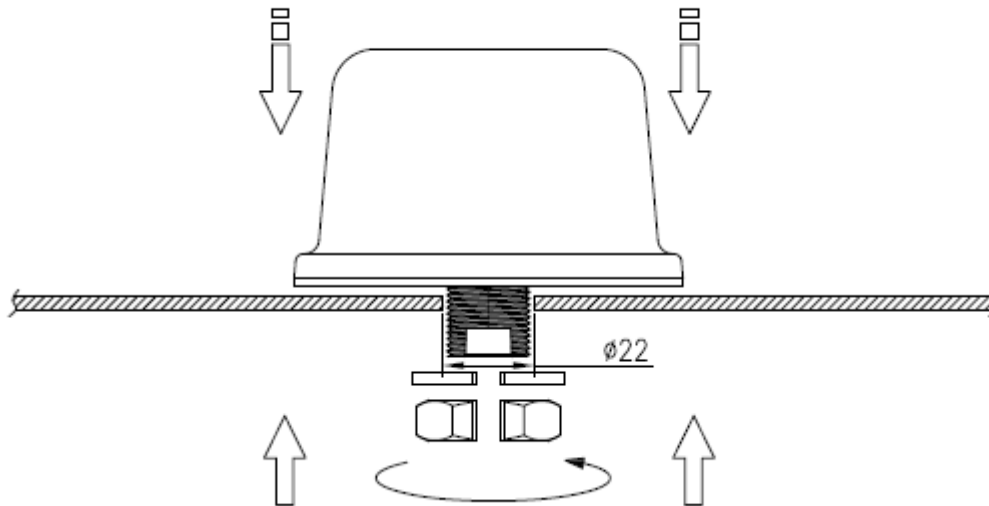

**Recommended torque for mounting: 5-7Nm**  
(Torque value obtained with antenna mounted on 1mm thick SUS-316 bracket)

## 7. Packaging

1 No. MA841.A.BI.002 per small box  
 Box Dimensions - 133 x 133 x 135mm  
 Weight - 350g

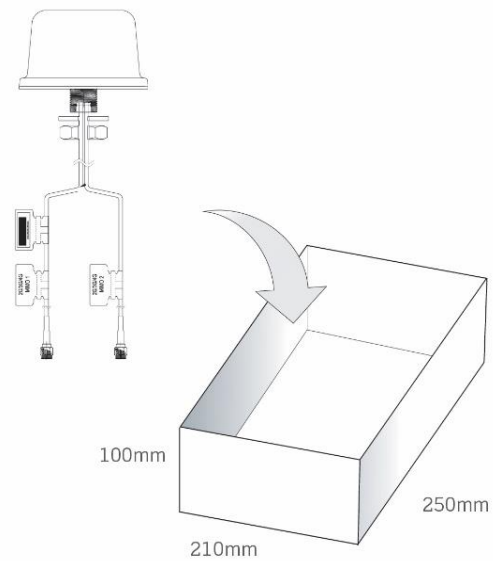

1 Outer Carton  
 Carton Dimensions - 590 x 310 x 140mm  
 8 pcs MA841.A.BI.002 per carton  
 Weight - 3.5Kg

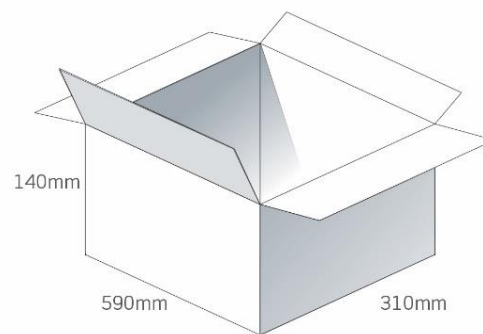

Pallet Dimensions 1200\*1000\*1460mm  
 54 Cartons per Pallet  
 9 Cartons per layer  
 6 Layers

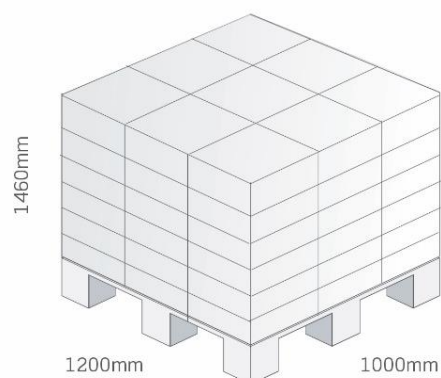

Changelog for the datasheet

**SPE-19-8-152 – MA841.A.BI.002**

**Revision: C (Current Version)**

Date:	2023-07-25
Notes:	Updated specifications
Author:	Cesar Sousa

**Previous Revisions**

**Revision: B**

Date:	2022-02-18
Notes:	Updated data, Coverage up to 6GHz.
Author:	Gary West

**Revision: A (Original First Release)**

Date:	2019-12-09
Notes:	
Author:	Jack Conroy



**TAOGLAS**®

[www.taoglas.com](http://www.taoglas.com)