

Features

- Ultra Broad Bandwidth: 50 MHz to 50 GHz
- Functional Bandwidth: 50 MHz to 70 GHz
- 0.3 dB Insertion Loss
- 46 dB Isolation @ 50 GHz
- Low Current Consumption
 - 5 V for Low Loss State
 - +10 mA for Isolation State
- Unique AlGaAs Hetero-Junction Anode Technology
- Silicon Nitride Passivation
- Polymer Scratch Protection
- RoHS* Compliant

Applications

- Aerospace & Defense
- ISM

Description

The MA4AGSW1 is an aluminum-gallium-arsenide, single pole, single throw (SPST), PIN diode switch. The switch features enhanced AlGaAs anodes which are formed using a patented hetero-junction technology. This technology produces a switch with less loss than conventional GaAs processes. As much as a 0.3 dB reduction in insertion loss can be realized at 50 GHz. These devices are fabricated on an OMCVD epitaxial wafer using a process designed for high device uniformity and extremely low parasitics. The diodes themselves exhibit low series resistance, low capacitance, and fast switching speed. They are fully passivated with silicon nitride and have an additional polymer layer for scratch protection. The protective coating prevents damage to the diode junction and anode air-bridges during handling and assembly. Off chip bias circuitry is required.

The high electron mobility of AlGaAs and the low capacitance of the PIN diodes makes this switch ideal for fast switching, high frequency, multi-throw switch designs. These AlGaAs PIN switches are used in switching arrays for radar systems, radiometers, test equipment and other multi-assembly components.

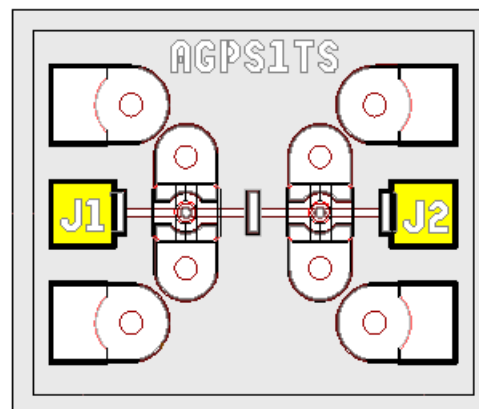

Yellow areas indicate bond pads

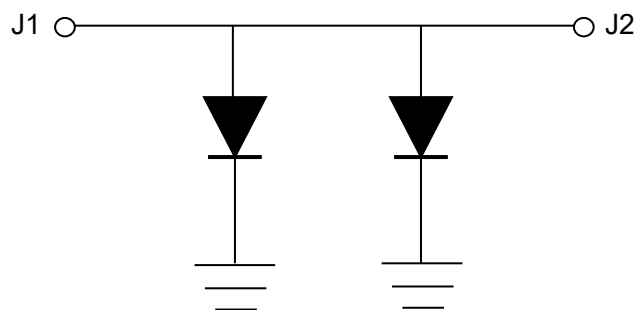

Ordering Information

Part Number	Package
MA4AGSW1	Waffle Pack

* Restrictions on Hazardous Substances, compliant to current RoHS EU directive.

Electrical Specifications: $T_A = +25^\circ\text{C}$ (on wafer measurements)

Parameter	Test Conditions	Units	Min.	Typ.	Max.
Insertion Loss	-5 V, 0.05 - 18 GHz -5 V, 18 - 50 GHz	dB	—	0.2 0.3	0.3 0.6
Isolation	10 mA, 0.05 - 18 GHz 10 mA, 18 - 50 GHz	dB	20 40	22 46	—
Input & Output Return Loss	-5 V, 0.05 - 18 GHz -5 V, 18 - 50 GHz	dB	—	30 16	—
Switching Speed	10% -90% RF Voltage, 10 GHz	ns	—	10	—

1. Typical switching speed is measured from 10% to 90% of the detected RF voltage driven by a TTL compatible driver. Driver output parallel RC network uses a capacitor between 390 pF - 560 pF and a resistor between 150 - 220 Ω to achieve 10 ns rise and fall times.

Absolute Maximum Ratings @ $T_A = +25^\circ\text{C}$

Parameter	Maximum Rating
Incident CW RF Power ²	+23 dBm CW
Breakdown Voltage	25 V
Bias Current	± 25 mA
Junction Temperature	+150°C
Operating Temperature	-55°C to +125°C
Storage Temperature	-55°C to +150°C

2. Maximum combined operating conditions for RF Power, DC bias, and temperature: +23 dBm CW @ 10 mA (per diode) @ +85°C.

Typical RF Performance (Probed on Wafer)

Insertion Loss @ -5 V

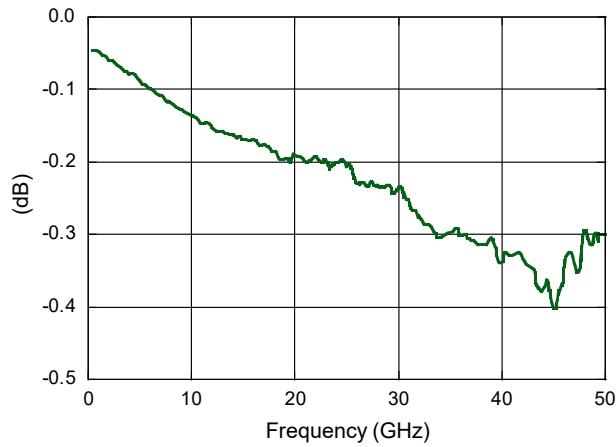

Isolation @ +10 mA (J2)

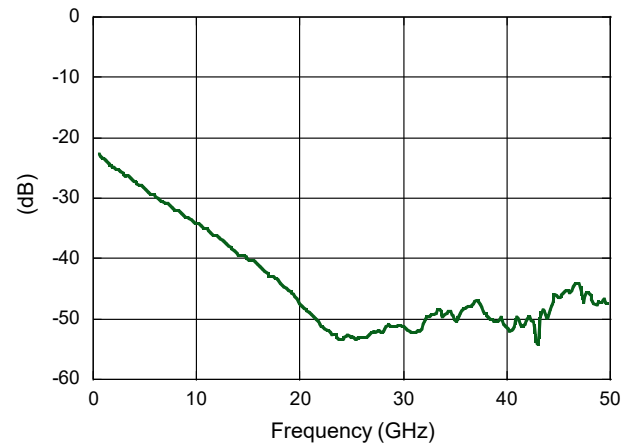

Input Return Loss @ -5 V

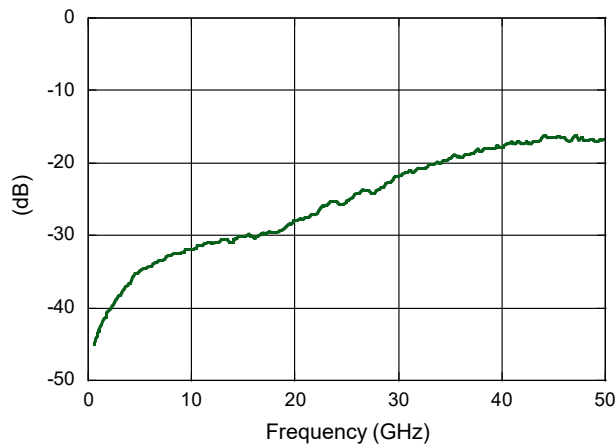

Output Return Loss @ -5 V

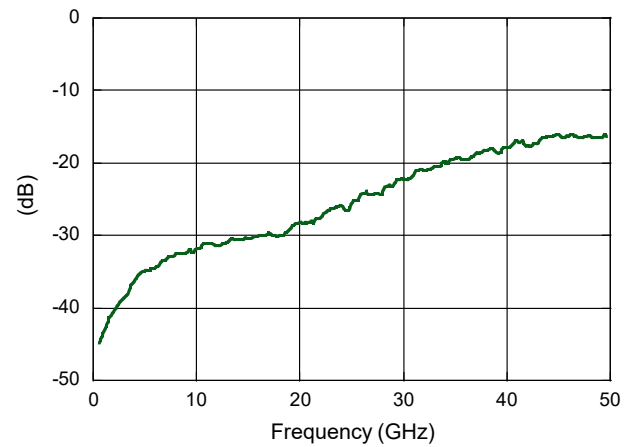

Operation of the MA4AGSW1 Switch

The MA4AGSW1 is a single-pole single-throw reflective switch, comprising a pair of shunt AlGaAs PIN diodes. The underside of this die is fully metalized and forms the DC, RF, and thermal ground connection of the switch.

Low insertion loss state is produced when 0 V or a negative DC bias voltage is applied through a bias decoupling network, such as a bias tee, to either the J1 or J2 port.

The switch produces high isolation state between the RF ports when a forward bias current is applied through a bias tee to either J1 or J2. This current is recommended to be 10 mA and must be less than the absolute maximum rated bias current of 25 mA. The typical forward voltage of each diode in the switch is 1.4 V when 10 mA is applied.

MACOM recommends the bias tee should produce a minimum of 30 dB isolation between the RF signal path and the bias source. Please refer to the data sheets for MACOM's integrated HMIC™ bias tees, MA4BN1840-1 and MA4BN1840-2 or MABT-011000, available from www.macom.com, for additional information.

Schematic with 2 - 18 GHz Bias Network

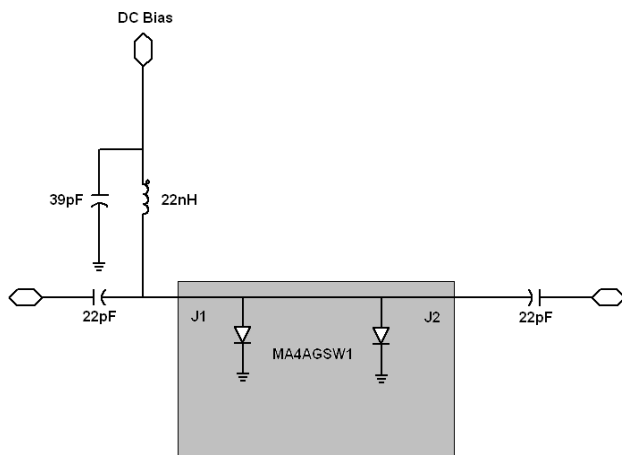

Note: The bias network can be connected to either J1 or J2

Chip & Bonding Pad Locations (In Yellow)

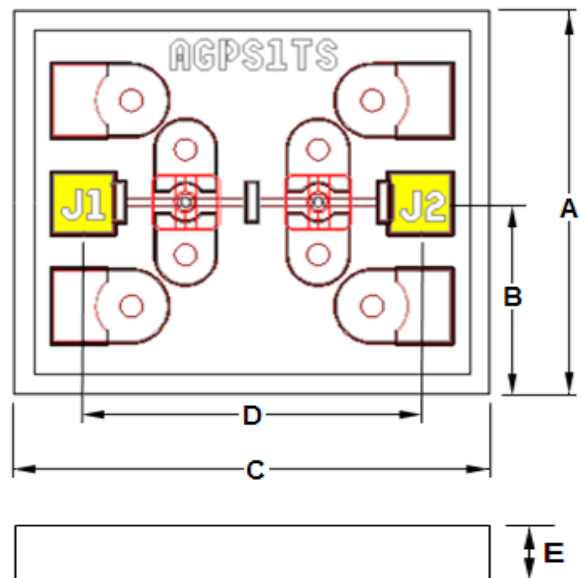

Typical Driver Connections

Control Level (DC Current)	RF Output State
J1 or J2	J1-J2
-5 V	Low Loss
+10 mA	Isolation

Dimensions

Dim.	Mils		Millimeters	
	Min.	Max.	Min.	Max.
A	23.5	25.5	0.597	0.648
B	11.75	12.75	0.299	0.324
C	28.50	30.50	0.724	0.775
D	20.50	21.00	0.521	0.533
E	3.50	4.50	0.089	0.114
Pads X-Y	3.50	4.50	0.089	0.114

Assembly Instructions:

Cleanliness

These chips should be handled in a clean environment.

Static Sensitivity

These Devices are considered ESD Class 0 HBM. Proper ESD techniques should be used when handling these devices.

General Handling

The protective polymer coating on the active areas of the die provides scratch and impact protection, particularly for the metal air bridge, which contacts the diode's anode. Die should primarily be handled with vacuum pickups, or alternatively with plastic tweezers.

Assembly Technique

The MA4AGSW1, AlGaAs switch is designed to be mounted with electrically conductive silver epoxy or with a lower temperature solder perform, which does not have a rich tin content.

Solder Die Attach

All die attach and bonding methods should be compatible with gold metal. Solder which does not scavenge gold, such as 80/20, Au/Sn or Indalloy #2 is recommended. Do not expose die to temperatures greater than 300°C for more than 10 seconds.

Electrical Conductive Epoxy Die Attach

Use a controlled thickness of approximately 2 mils for best electrical conductivity and lowest thermal resistance. Cure epoxy per manufacturer's schedule. Typically 150°C for 1 hour.

Ribbon / Wire Bonding

Thermo-compression wedge or ball bonding may be used to attach ribbons or wire to the gold bonding pads. A 1/4 x 3 mil gold ribbon is recommended on all RF ports and should be kept as short as possible for the lowest inductance and best microwave performance. For more detailed handling and assembly instructions, see Application Note M541.

MACOM Technology Solutions Inc. ("MACOM"). All rights reserved.

These materials are provided in connection with MACOM's products as a service to its customers and may be used for informational purposes only. Except as provided in its Terms and Conditions of Sale or any separate agreement, MACOM assumes no liability or responsibility whatsoever, including for (i) errors or omissions in these materials; (ii) failure to update these materials; or (iii) conflicts or incompatibilities arising from future changes to specifications and product descriptions, which MACOM may make at any time, without notice. These materials grant no license, express or implied, to any intellectual property rights.

THESE MATERIALS ARE PROVIDED "AS IS" WITH NO WARRANTY OR LIABILITY, EXPRESS OR IMPLIED, RELATING TO SALE AND/OR USE OF MACOM PRODUCTS INCLUDING FITNESS FOR A PARTICULAR PURPOSE, MERCHANTABILITY, INFRINGEMENT OF INTELLECTUAL PROPERTY RIGHT, ACCURACY OR COMPLETENESS, OR SPECIAL, INDIRECT, INCIDENTAL, OR CONSEQUENTIAL DAMAGES WHICH MAY RESULT FROM USE OF THESE MATERIALS.

MACOM products are not intended for use in medical, lifesaving or life sustaining applications. MACOM customers using or selling MACOM products for use in such applications do so at their own risk and agree to fully indemnify MACOM for any damages resulting from such improper use or sale.