



TAOGLAS®



Datasheet

Storm

Part No:
MA413.A.B.004

Description:

Low Profile 5G/4G Permanent Mount Antenna

Features:

- 600-6000MHz 5G/4G Antenna
- Screw-Mount [Permanent Mount]
- Worldwide 5G/4G Bands including 3G and 2G
- Aerodynamic, Super Low-profile Vandal Resistant Housing
- IP67 Enclosure
- Dimensions: 216.24*93.25*30.95mm
- 5m CFD200 with SMA(M) connector
- Custom Cables and Connectors Available
- CE Certified
- RoHS and REACH Compliant

1. Introduction	3
2. Specifications	4
3. Antenna Characteristics	7
4. Radiation Patterns	9
5. Mechanical Drawing	34
6. Installation	35
7. Packaging	36
<hr/>	
Changelog	37

Taoglas makes no warranties based on the accuracy or completeness of the contents of this document and reserv make changes to specifications and product descriptions at any time without notice. Taoglas reserves all rights to this document and the information contained herein. Reproduction, use or disclosure to third parties without express permission is strictly prohibited.



1. Introduction



The Storm MA413 antenna is a low profile, heavy-duty, fully IP67 waterproof external M2M antenna for use in worldwide telematics applications which combine Global Cellular communications. The MA413 delivers best in class 5G/4G antenna performance. You will never be out of touch with this extremely robust, reliable, high gain antenna.

At only 31mm high, the Storm is the world's lowest profile global telematics antenna solution. It delivers powerful worldwide 5G/4G antenna technology while also covering the 3G and 2G bands.

Typical applications:

- Transportation
- HD Video Streaming
- First Responder and Emergency Services
- Internet of Things (IoT market)
- Wireless M2M Devices
- Digital Signage

LTE 4G applications demand high speed data uplink and downlink. The MA413 does not require a ground plane. Low loss cables are used to keep efficiency high over long cable lengths. Cable length and connector types are fully customizable. Contact your regional Taoglas customer support team for further information.

2. Specifications

Electrical

Band	Frequency (MHz)		Efficiency (%)	Average Gain (dB)	Peak Gain (dBi)	Impedance	VSWR	Polarization
5G NR/4G Band 71	617~698	Free space	24	-6.8	2.4	50Ω	< 3	Linear
		50cmX50cm Groundplane	22	-7.8	2.0			
4G/3G Band 12,13,14,17,28,29	698~806	Free space	37	-4.4	2.1			
		50cmX50cm Groundplane	40	-4.1	3.3			
4G/3G/NB-IoT/Cat M Band 5,8,18,19,20,26,27	824~960	Free space	33	-4.9	1.9			
		50cmX50cm Groundplane	37	-4.3	1.9			
5G NR/4G Band 21,32,74,75,76	1427~1518	Free space	24	-6.4	3.1			
		50cmX50cm Groundplane	23	-6.6	4.0			
4G/3G Band 1,2,3,4,9,23,25,35,39,66	1710~2200	Free space	31	-5.4	5.0			
		50cmX50cm Groundplane	31	-5.4	5.4			
4G/3G Band 7,30,38,40,41	2300~2690	Free space	29	-5.4	4.9			
		50cmX50cm Groundplane	29	-5.4	5.0			
5G NR/4G Band 22,42,48,77,78,79	3300~4200	Free space	25	-6.1	4.1			
		50cmX50cm Groundplane	24	-6.2	4.4			
LTE5200/ Wi-Fi 5800	5150~5925	Free space	16	-8.0	1.5			
		50cmX50cm Groundplane	16	-8.0	1.3			

Mechanical	
Dimensions	216.24*93.25*30.95mm
Casing	ABS+PC
Base and thread	Nickel Plated Aluminum
Weight (including cable)	570g
IP Rating	IP67
Recommended Assembly Torque	5-7 N-m
Cable	5 meter CFD200 standard, fully customizable
Connector	SMA Male connector, fully customizable
Environmental	
Operation Temperature	-40°C to 85°C
Storage Temperature	-40°C to 90°C
Humidity	Non-condensing 65°C 95% RH

5G/4G Bands			
Band Number	5GNR / FR1 / LTE / LTE-Advanced / WCDMA / HSPA / HSPA+ / TD-SCDMA		
	Uplink	Downlink	Covered
1	UL: 1920 to 1980	DL: 2110 to 2170	✓
2	UL: 1850 to 1910	DL: 1930 to 1990	✓
3	UL: 1710 to 1785	DL: 1805 to 1880	✓
4	UL: 1710 to 1755	DL: 2110 to 2155	✓
5	UL: 824 to 849	DL: 869 to 894	✓
7	UL: 2500 to 2570	DL: 2620 to 2690	✓
8	UL: 880 to 915	DL: 925 to 960	✓
9	UL: 1749.9 to 1784.9	DL: 1844.9 to 1879.9	✓
11	UL: 1427.9 to 1447.9	DL: 1475.9 to 1495.9	✓
12	UL: 699 to 716	DL: 729 to 746	✓
13	UL: 777 to 787	DL: 746 to 756	✓
14	UL: 788 to 798	DL: 758 to 768	✓
17	UL: 704 to 716	DL: 734 to 746	✓
18	UL: 815 to 830	DL: 860 to 875	✓
19	UL: 830 to 845	DL: 875 to 890	✓
20	UL: 832 to 862	DL: 791 to 821	✓
21	UL: 1447.9 to 1462.9	DL: 1495.9 to 1510.9	✓
22	UL: 3410 to 3490	DL: 3510 to 3590	✓
23	UL: 2000 to 2020	DL: 2180 to 2200	✓
24	UL: 1625.5 to 1660.5	DL: 1525 to 1559	✓
25	UL: 1850 to 1915	DL: 1930 to 1995	✓
26	UL: 814 to 849	DL: 859 to 894	✓
27	UL: 807 to 824	DL: 852 to 869	✓
28	UL: 703 to 748	DL: 758 to 803	✓
29	UL: -	DL: 717 to 728	✓
30	UL: 2305 to 2315	DL: 2350 to 2360	✓
31	UL: 452.5 to 457.5	DL: 462.5 to 467.5	✗
32	UL: -	DL: 1452 - 1496	✓
35		1850 to 1910	✓
38		2570 to 2620	✓
39		1880 to 1920	✓
40		2300 to 2400	✓
41		2496 to 2690	✓
42		3400 to 3600	✓
43		3600 to 3800	✓
48		3550 to 3700	✓
66	UL: 1710-1780	DL: 2110-2200	✓
71		617 to 698	✓
74/75/76		1427 to 1518	✓
78		3300 to 3800	✓
79		4400 to 5000	✓
85	698-716	728-746	✓

3. Antenna Characteristics

3.1 Return Loss

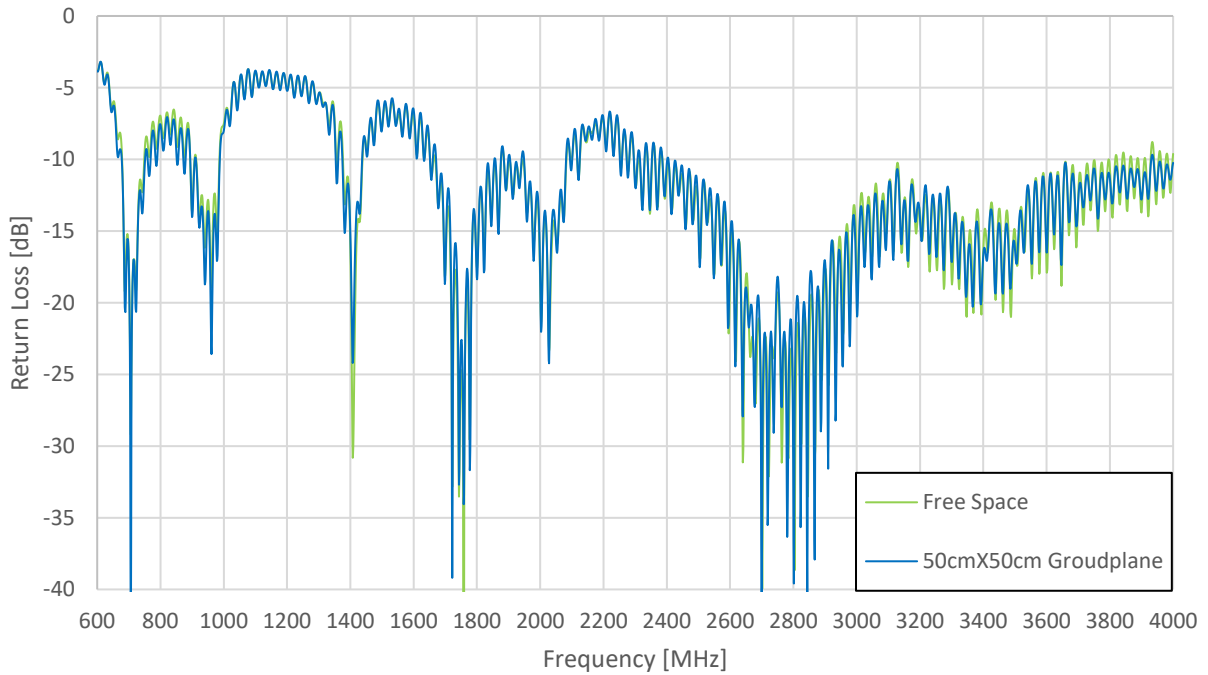

3.2 Efficiency

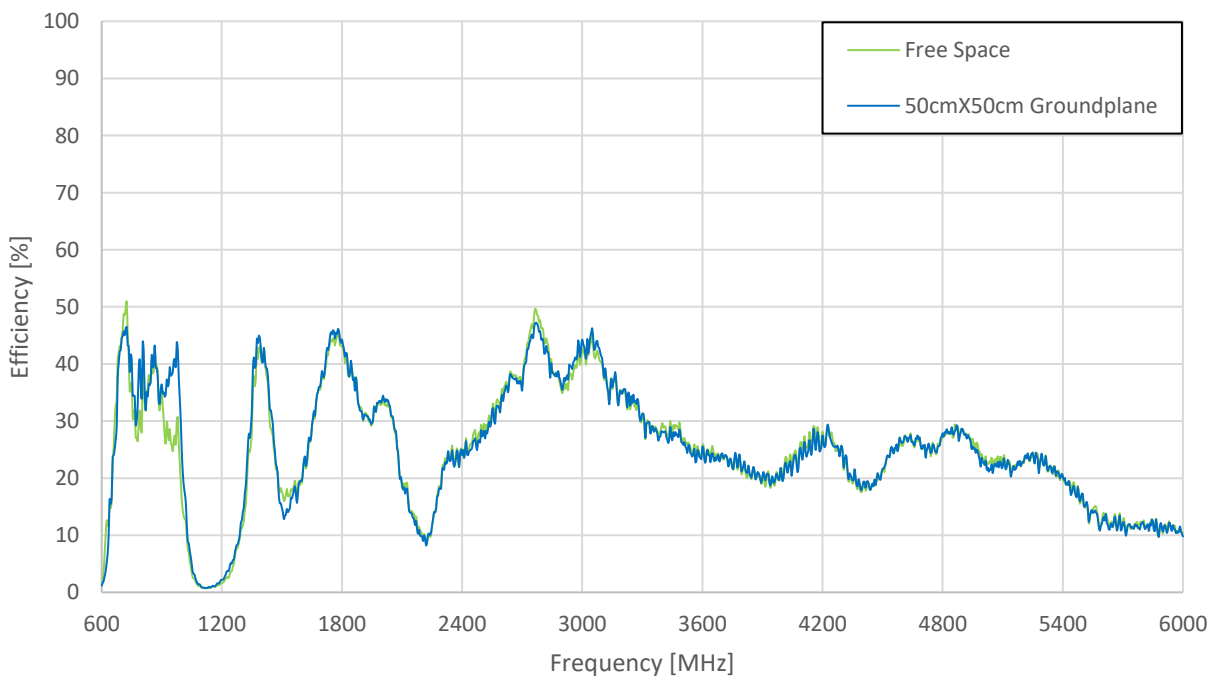

3.3 Peak Gain

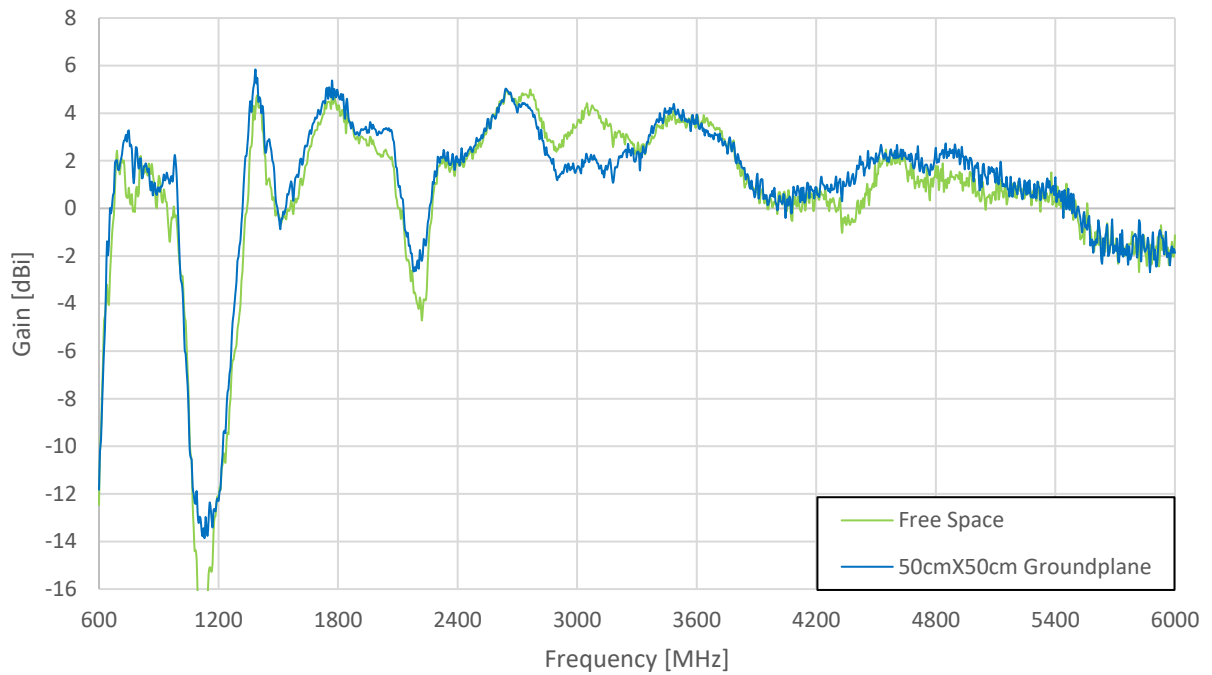

3.4 Average Gain

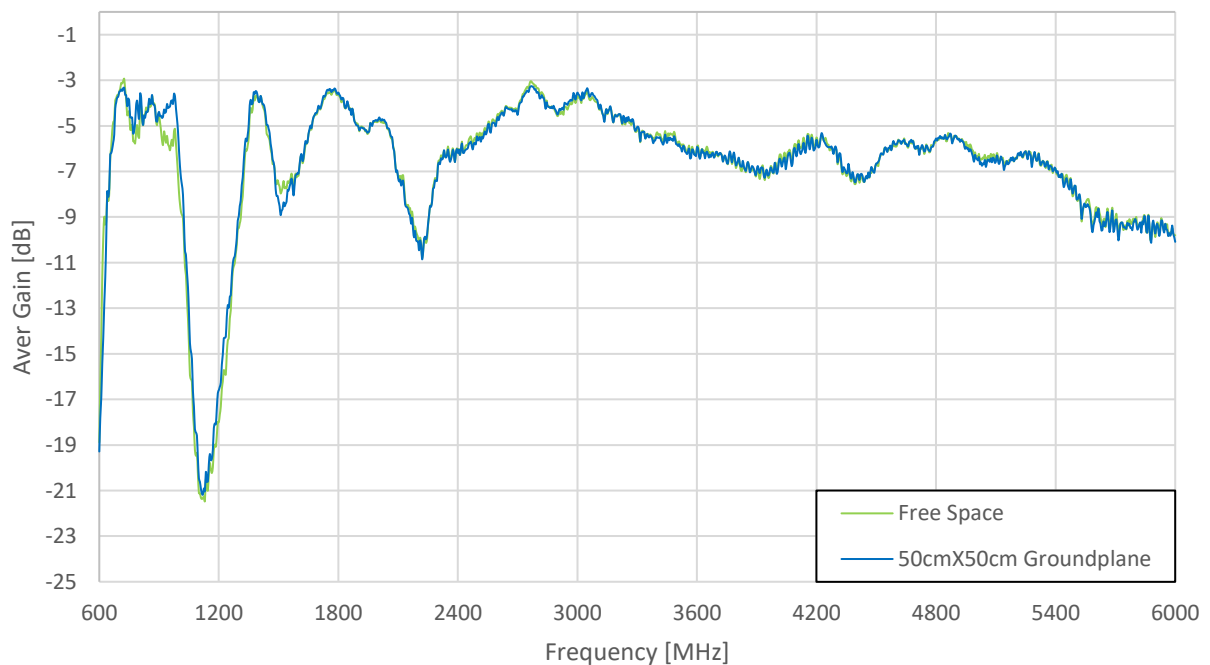

4. Radiation Patterns

4.1 Test Setup



50cmx50cm Ground Plane

Freespace

4.2 705MHz (Freespace) 3D and 2D Radiation Patterns

Azimuth = 0.0
Elevation = 0.0
Roll = -35.0

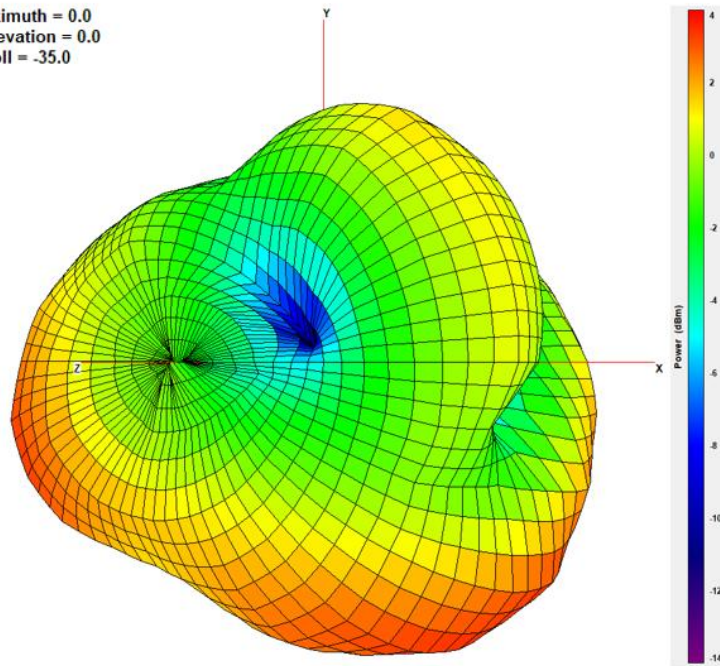

XY Plane

XZ Plane

YZ Plane

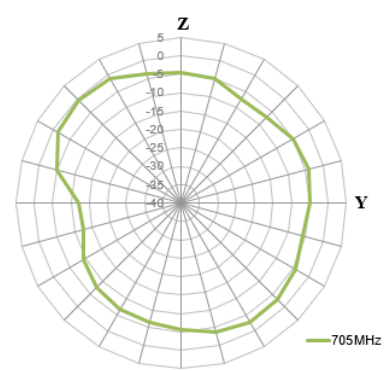
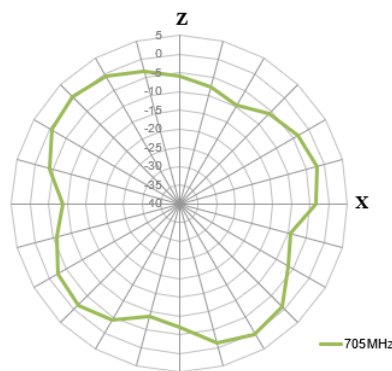
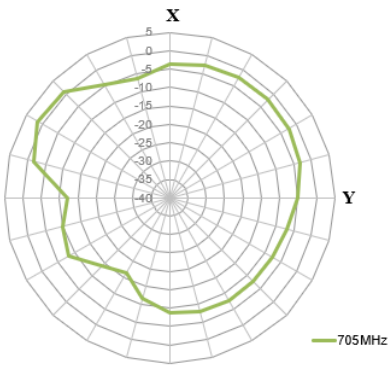

750MHZ

Azimuth = 0.0
Elevation = 0.0
Roll = -35.0

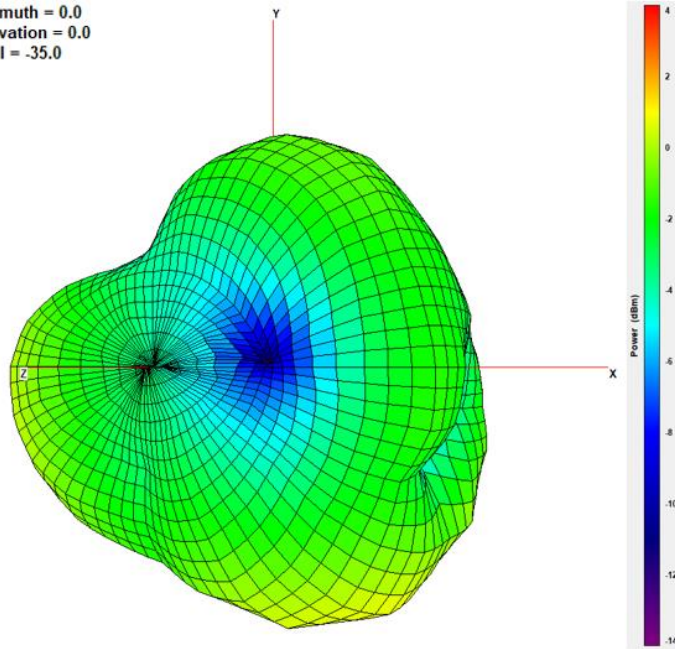

XY Plane

XZ Plane

YZ Plane

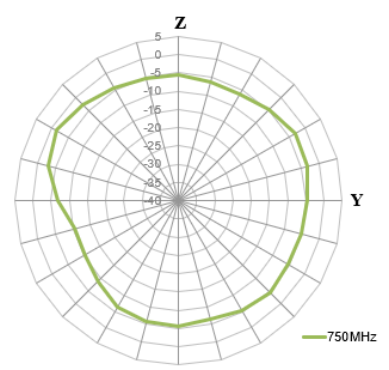
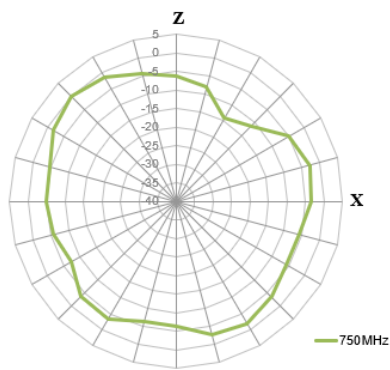
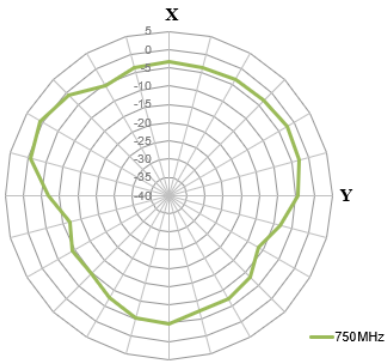

825MHz

Azimuth = 0.0
Elevation = 0.0
Roll = -35.0

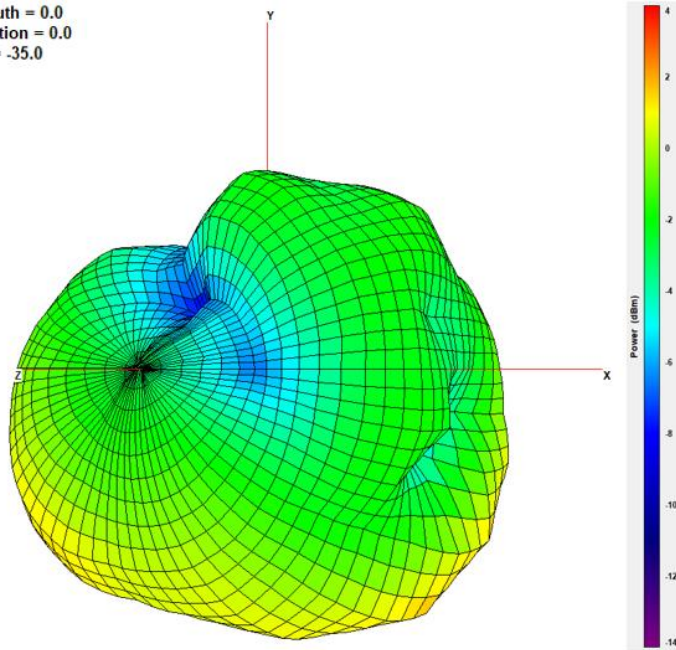

XY Plane

XZ Plane

YZ Plane

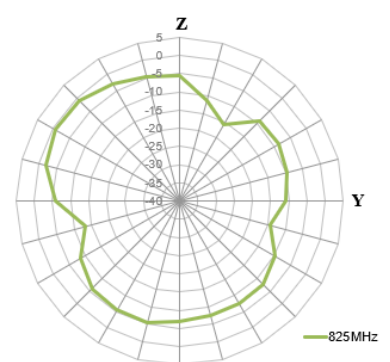
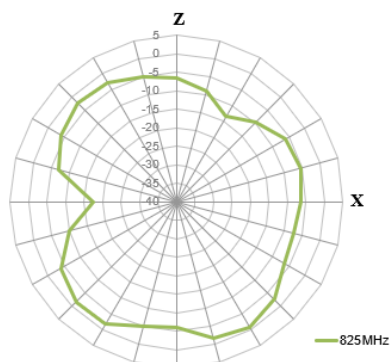
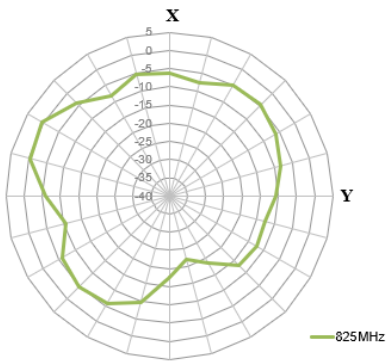

960MHz

Azimuth = 0.0
Elevation = 0.0
Roll = -35.0

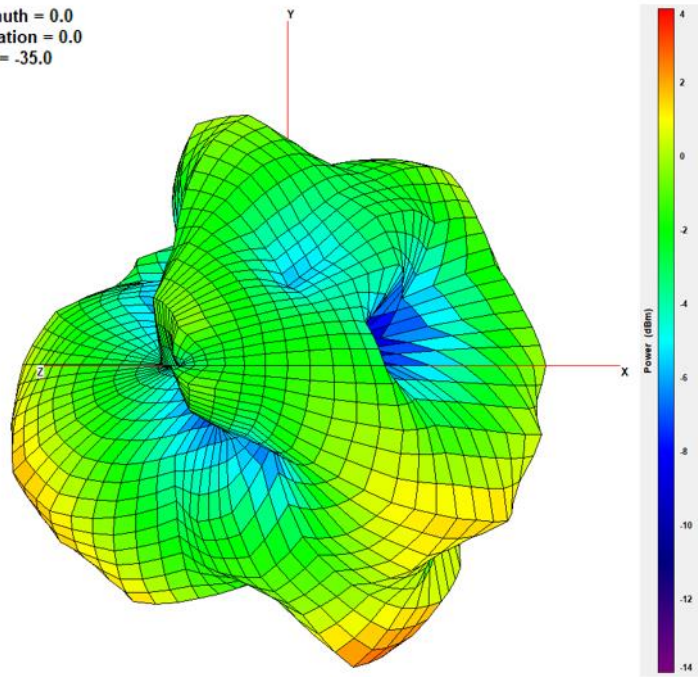

XY Plane

XZ Plane

YZ Plane

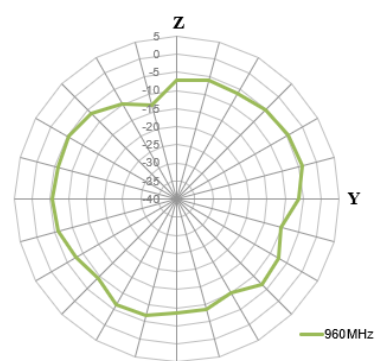
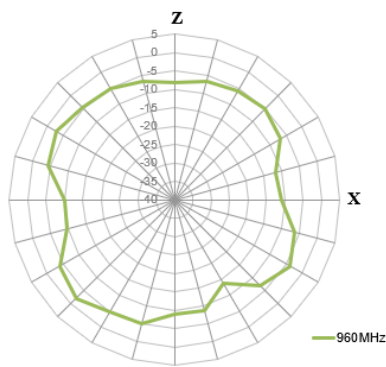
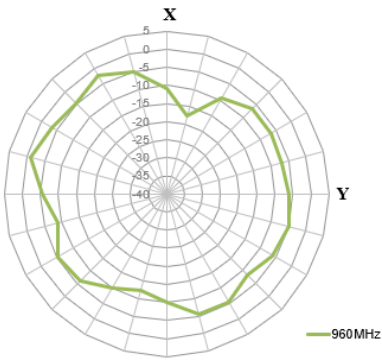

1710MHz

Azimuth = 0.0
Elevation = 0.0
Roll = -35.0

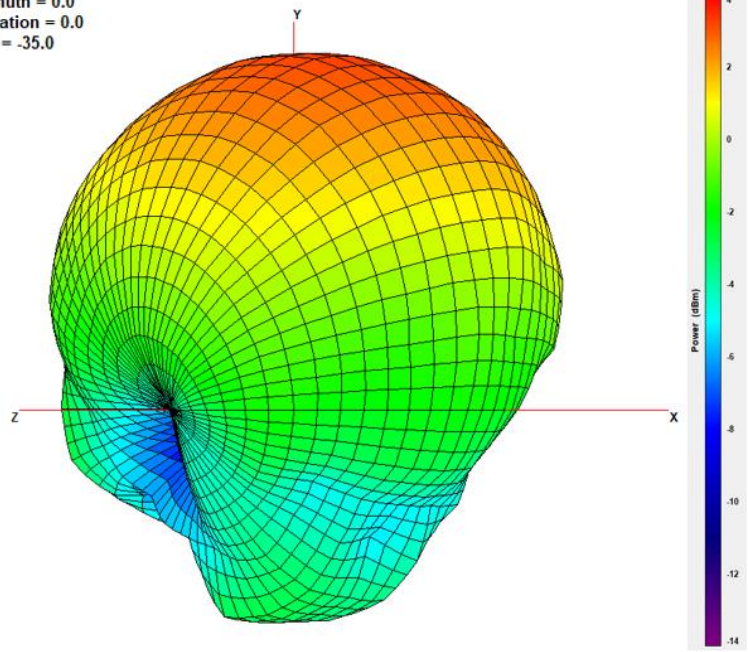

XY Plane

XZ Plane

YZ Plane

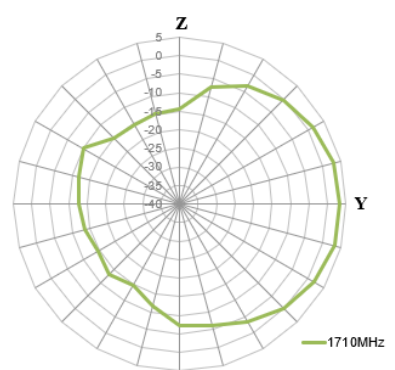
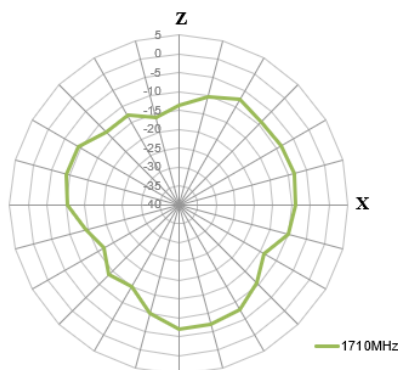
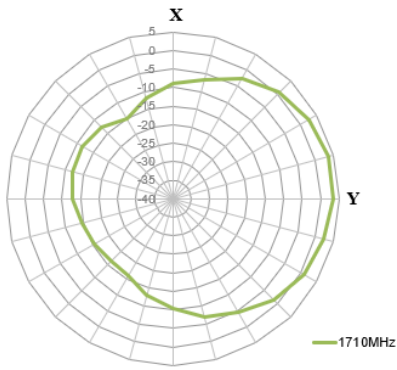

1850MHz

Azimuth = 0.0
 Elevation = 0.0
 Roll = -35.0

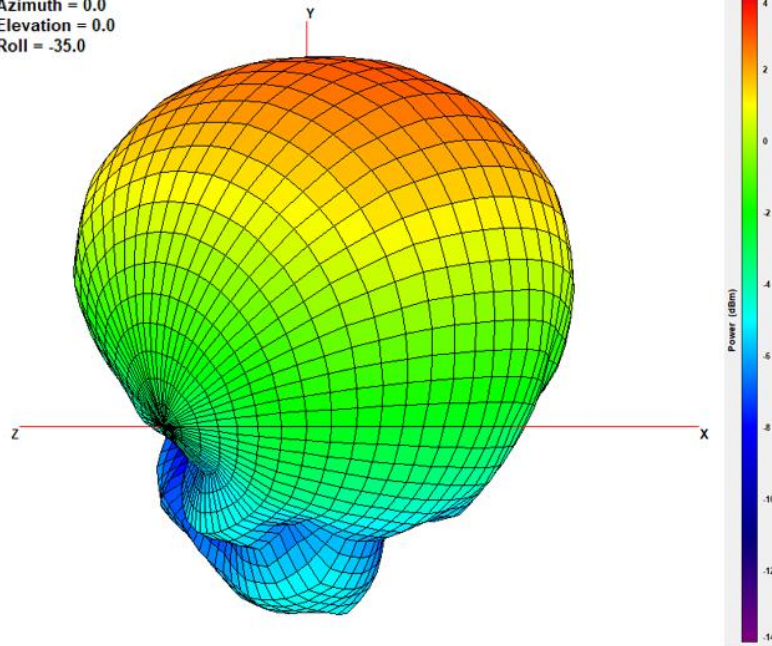

XY Plane

XZ Plane

YZ Plane

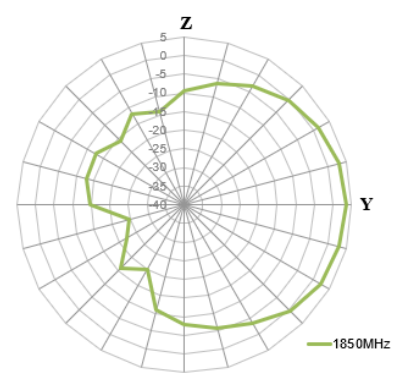
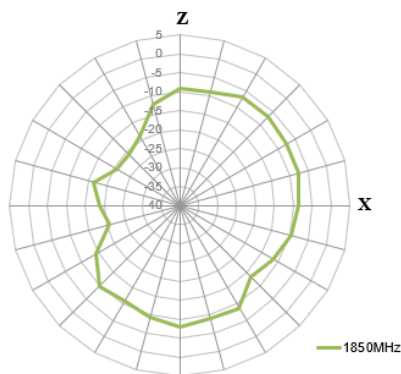
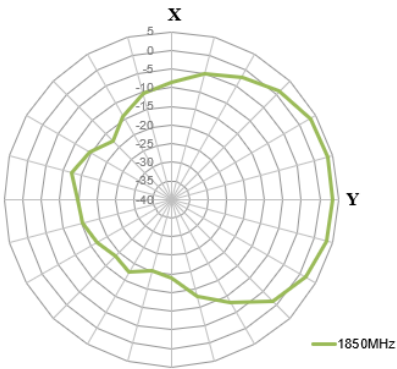

1990MHz

Azimuth = 0.0
Elevation = 0.0
Roll = -35.0

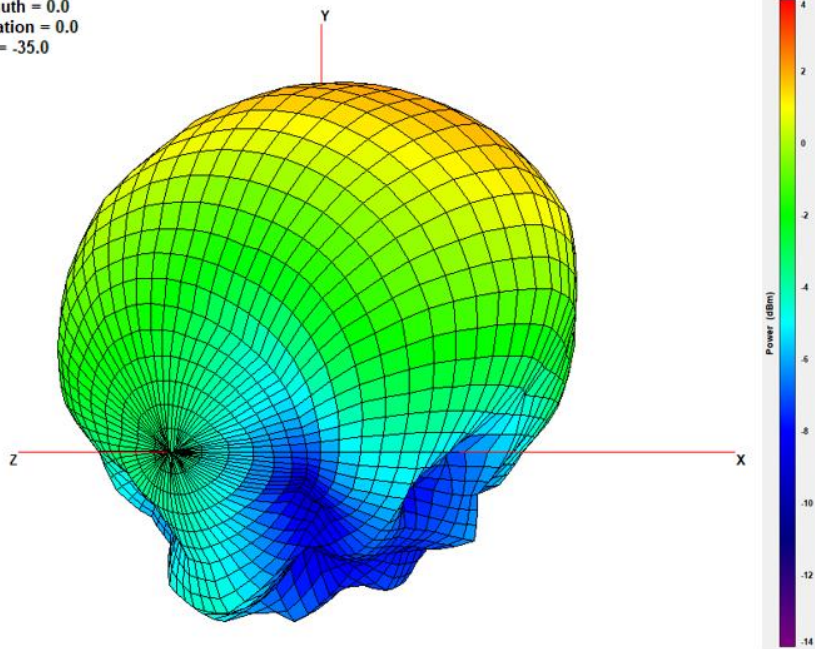

XY Plane

XZ Plane

YZ Plane

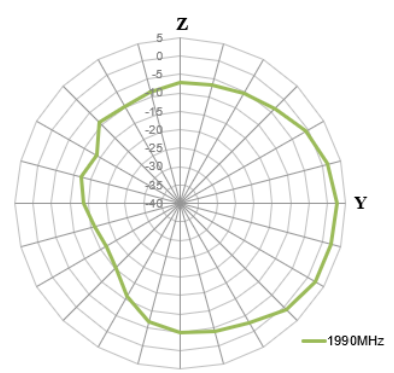
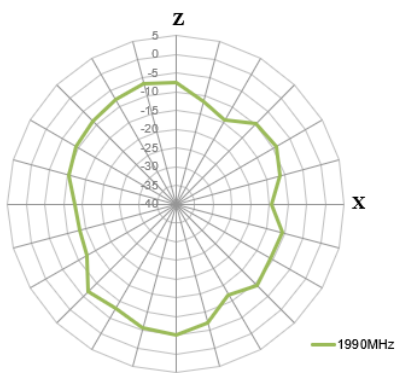
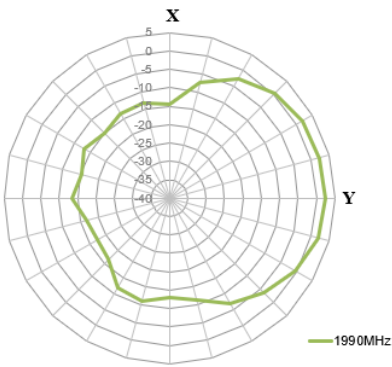

2170MHz

Azimuth = 0.0
Elevation = 0.0
Roll = -35.0

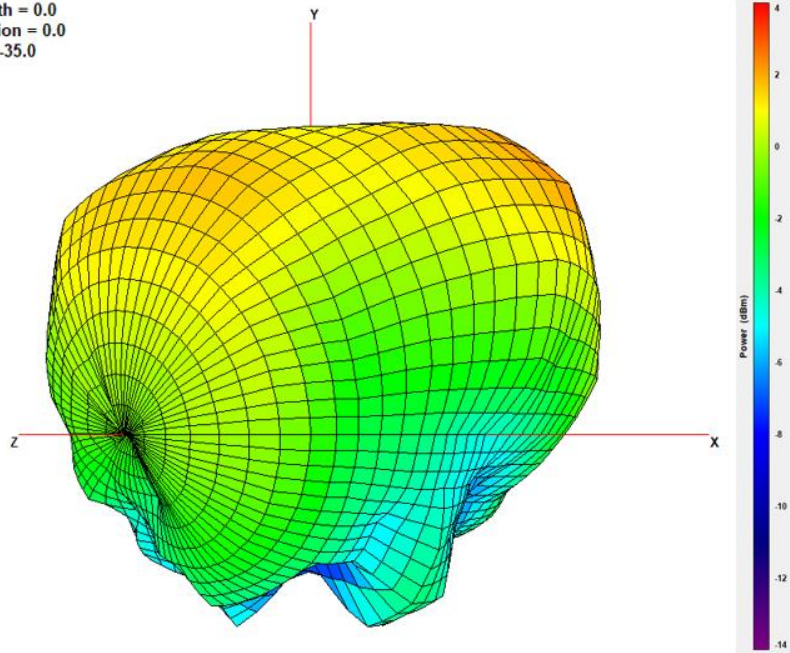

XY Plane

XZ Plane

YZ Plane

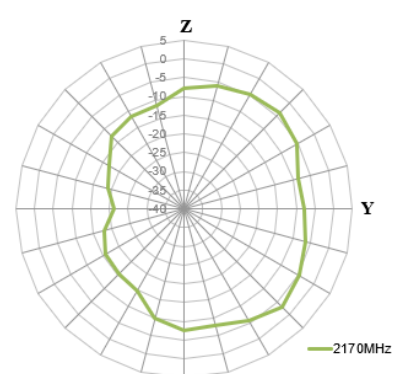
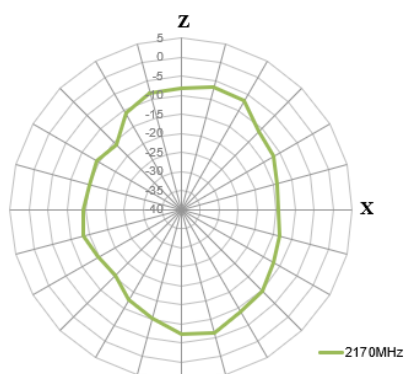
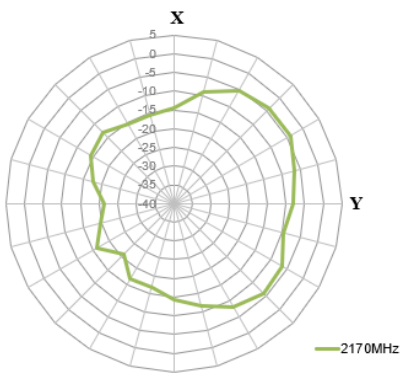

2500MHz

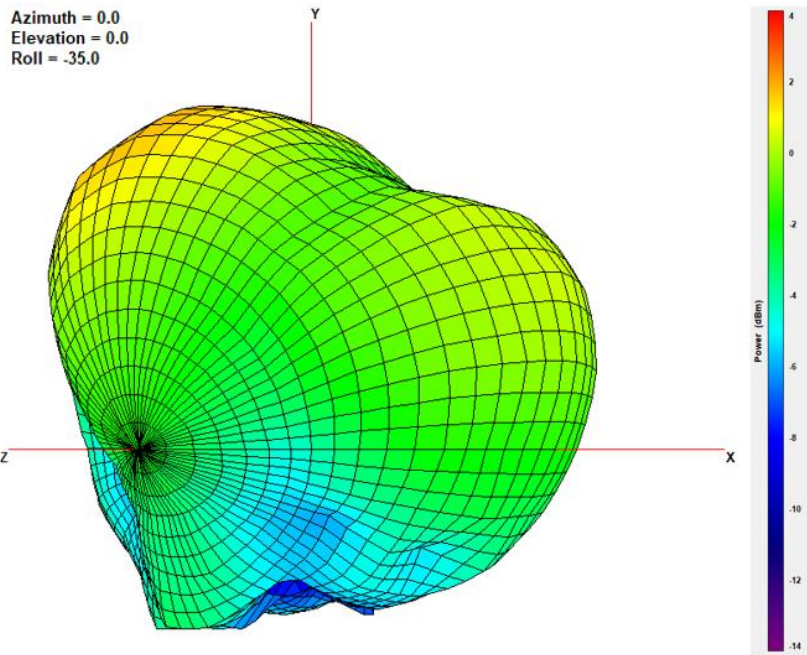

XY Plane

XZ Plane

YZ Plane

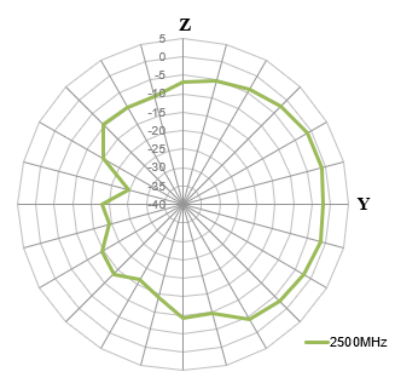
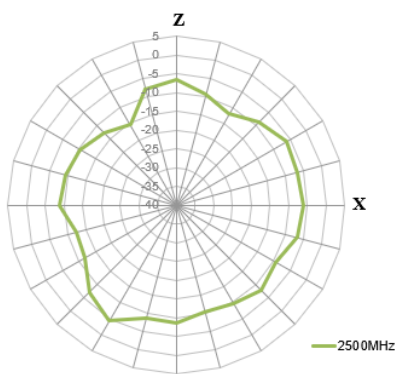
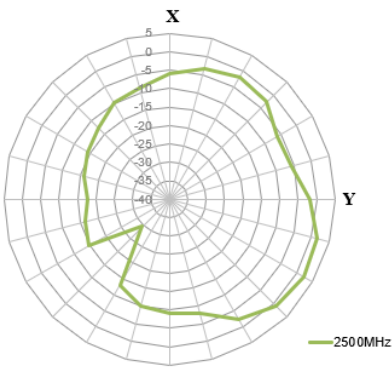

2690MHz

Azimuth = 0.0
Elevation = 0.0
Roll = -35.0

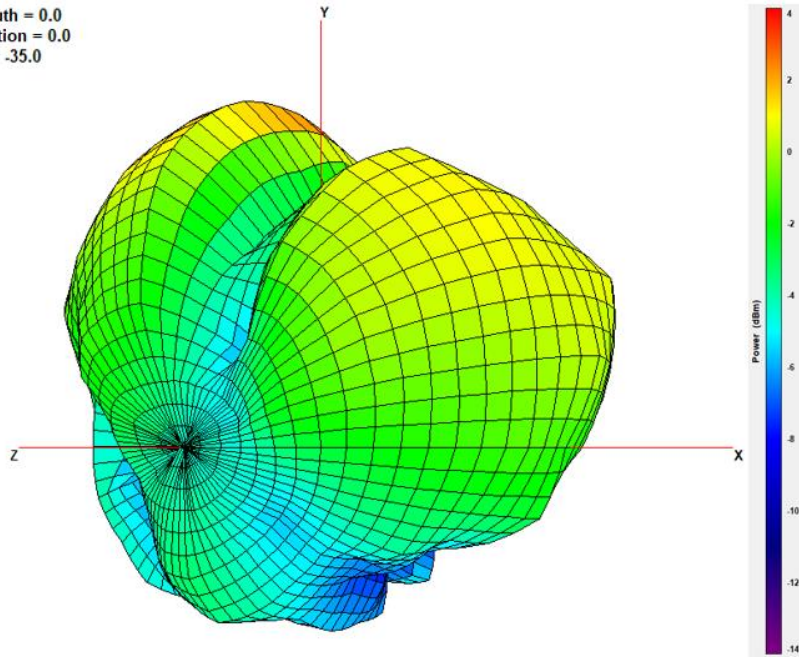

XY Plane

XZ Plane

YZ Plane

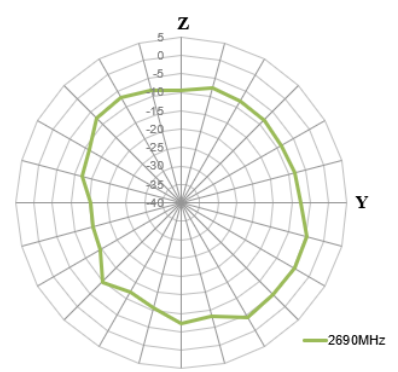
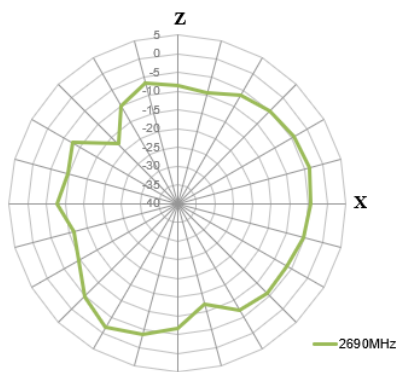
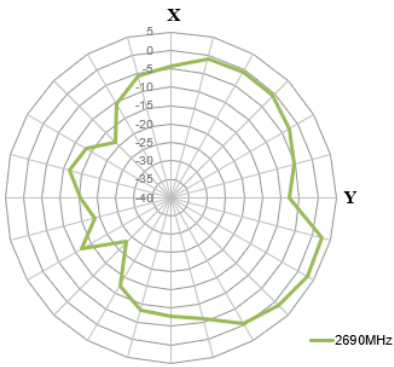

3300MHz

Azimuth = 0.0
Elevation = 0.0
Roll = -35.0

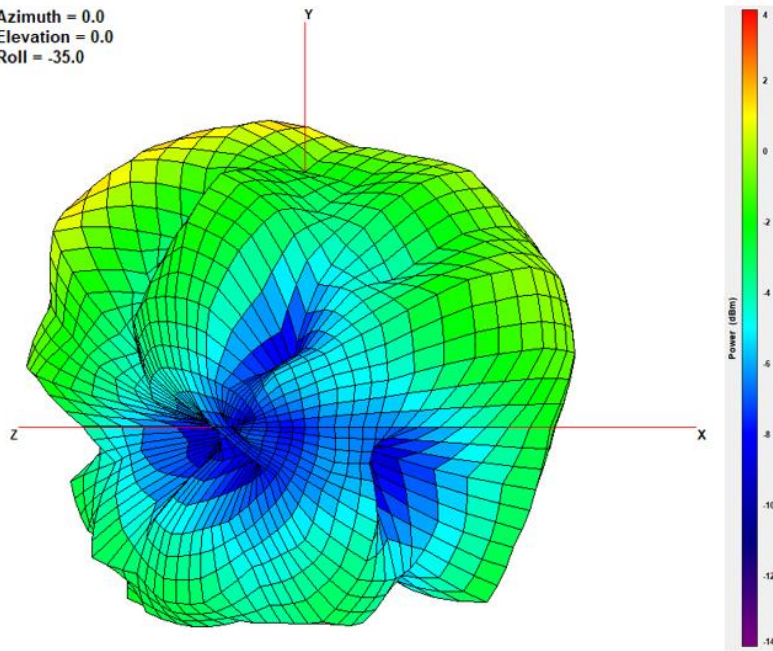

XY Plane

XZ Plane

YZ Plane

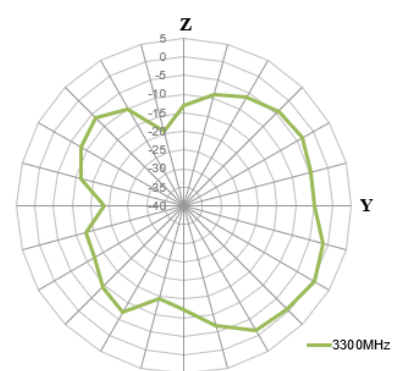
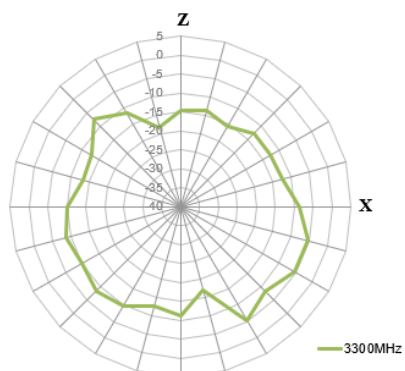
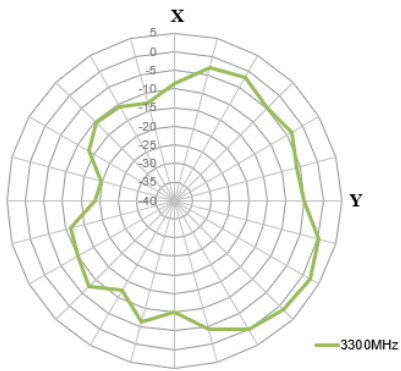

3500MHz

Azimuth = 0.0
Elevation = 0.0
Roll = -35.0

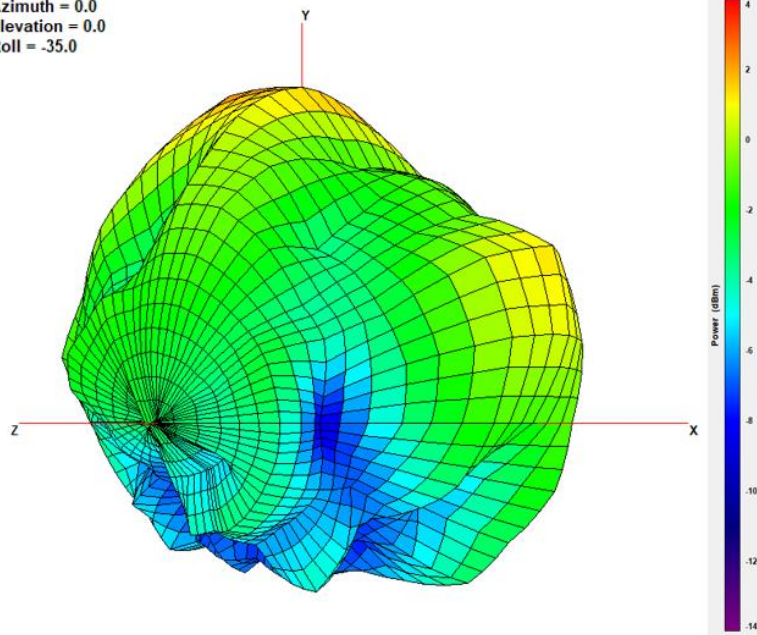

XY Plane

XZ Plane

YZ Plane

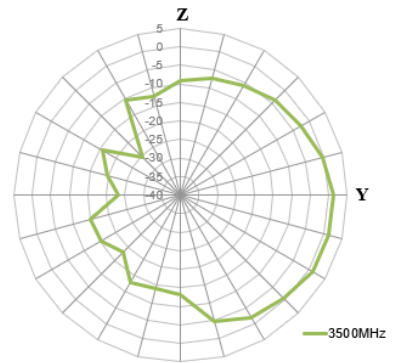
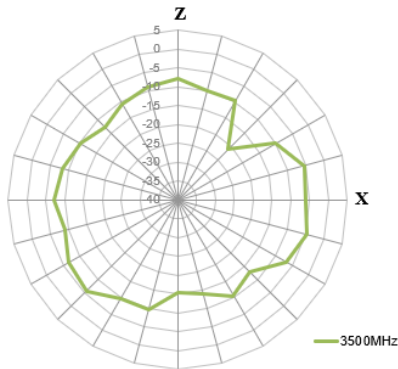
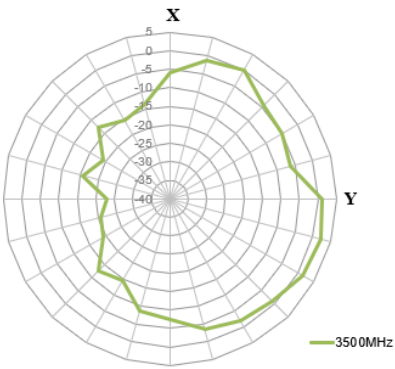

4.3 705MHz (50cm X 50cm Groundplane) 3D and 2D Radiation Patterns

Azimuth = 0.0
Elevation = 0.0
Roll = -35.0

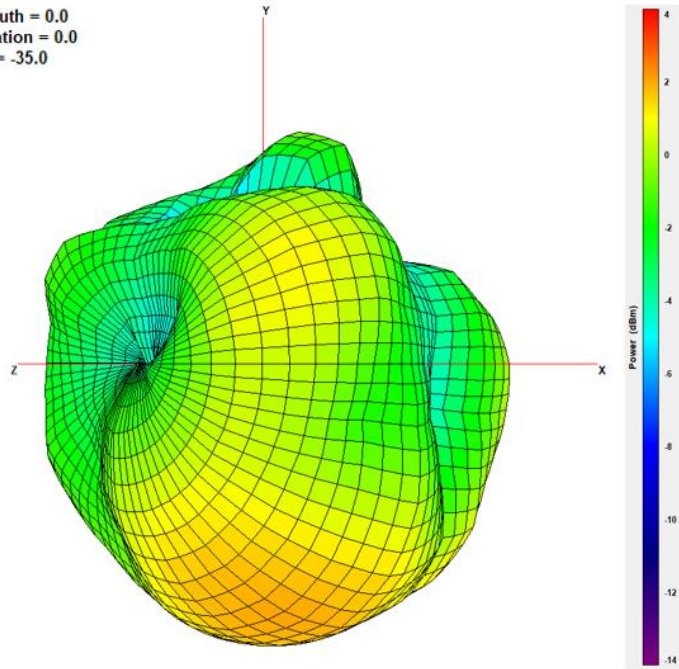

XY Plane

XZ Plane

YZ Plane

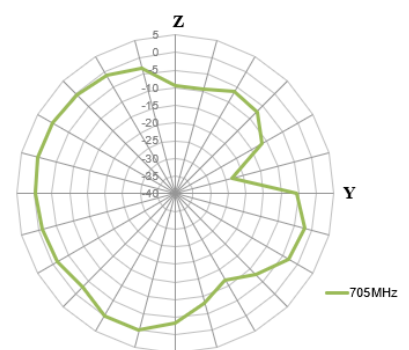
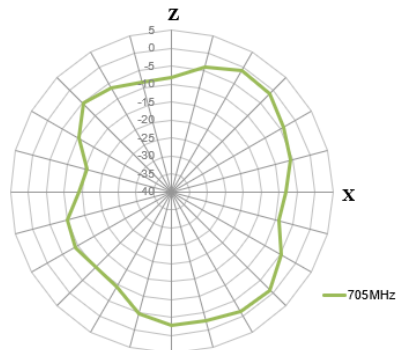
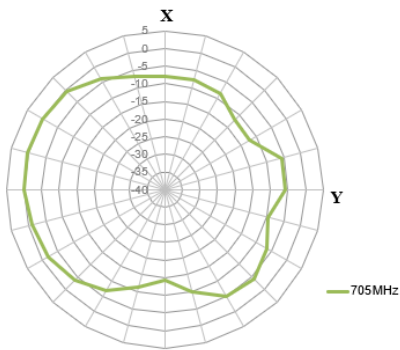

750MHZ

Azimuth = 0.0
Elevation = 0.0
Roll = -35.0

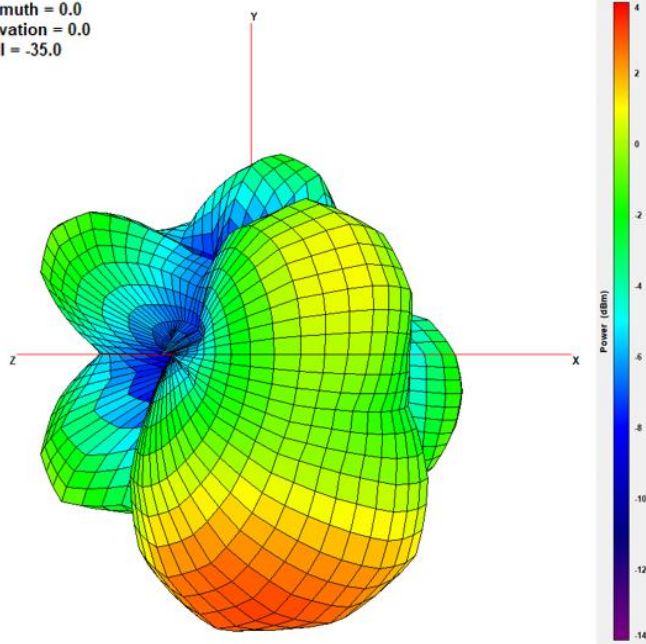

XY Plane

XZ Plane

YZ Plane

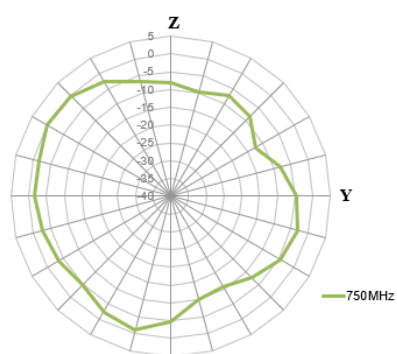
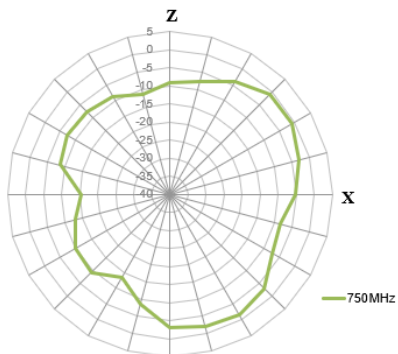
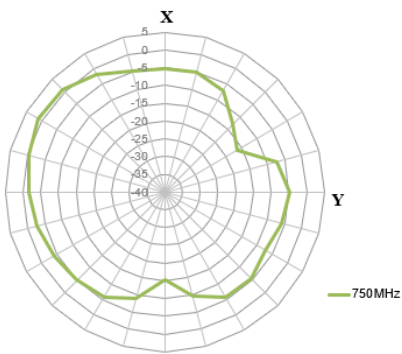

825MHz

Azimuth = 0.0
Elevation = 0.0
Roll = -35.0

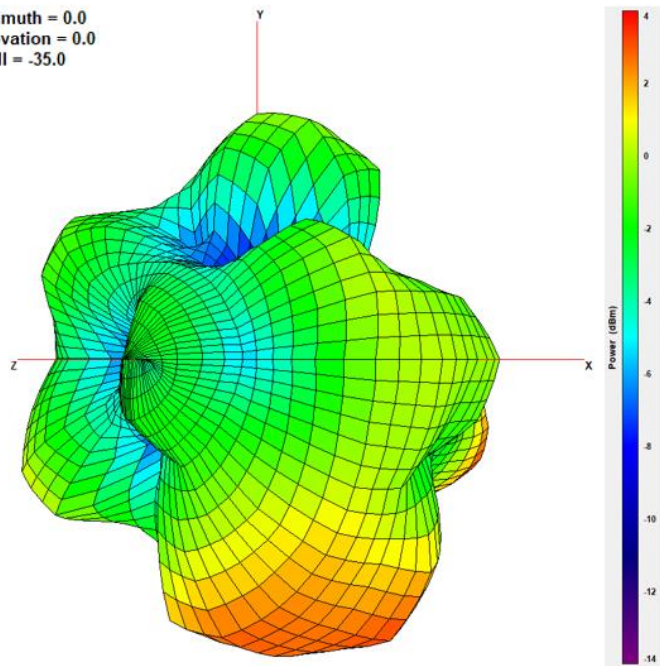

XY Plane

XZ Plane

YZ Plane

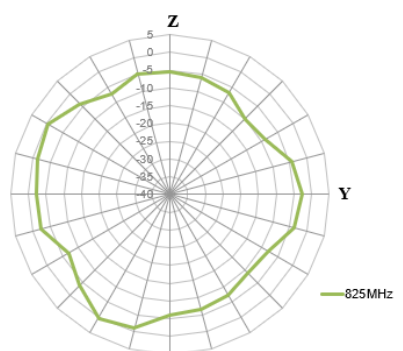
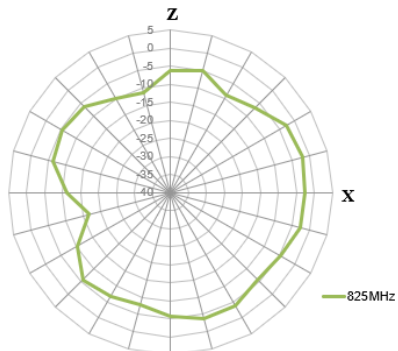
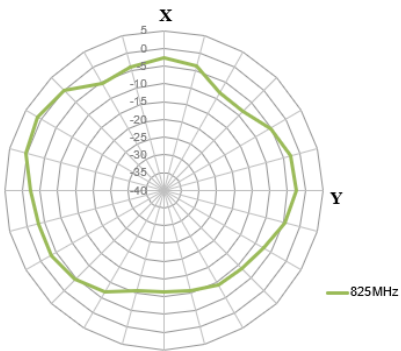

960MHz

Azimuth = 0.0
Elevation = 0.0
Roll = -35.0

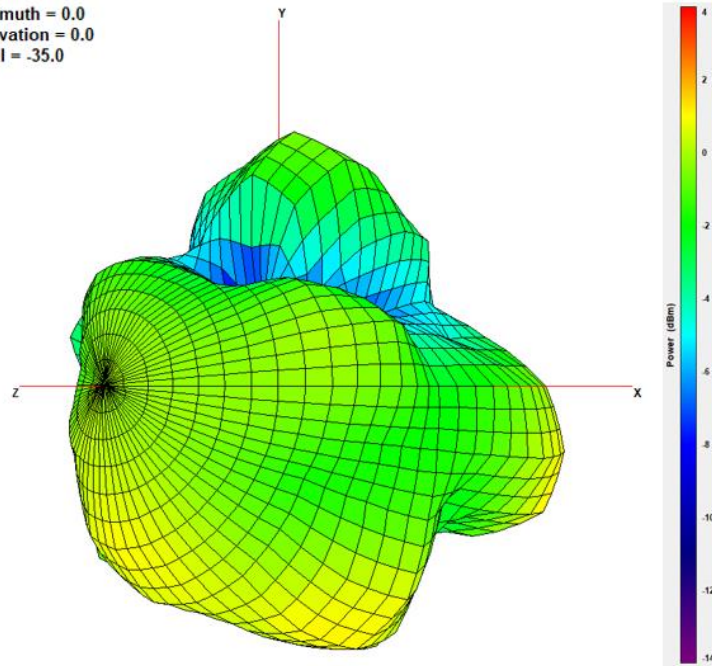

XY Plane

XZ Plane

YZ Plane

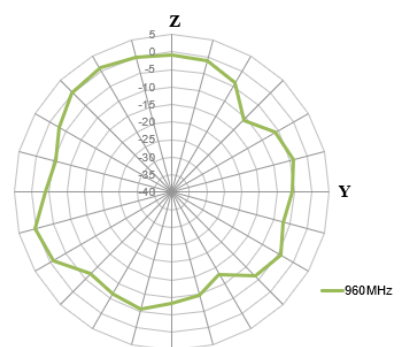
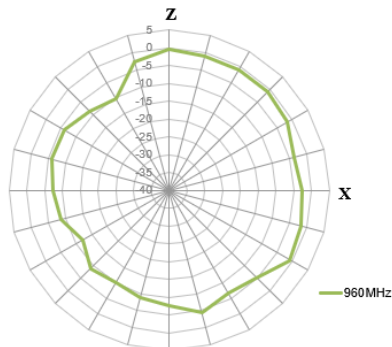
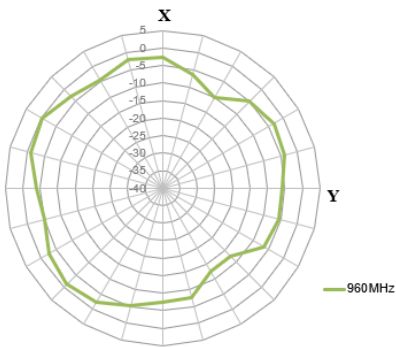

1710MHz

Azimuth = 0.0
Elevation = 0.0
Roll = -35.0

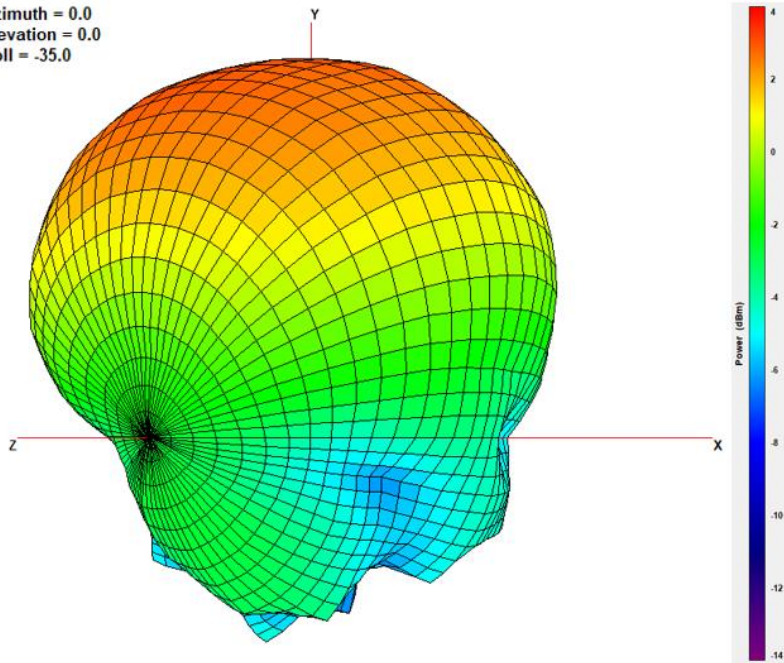

XY Plane

XZ Plane

YZ Plane

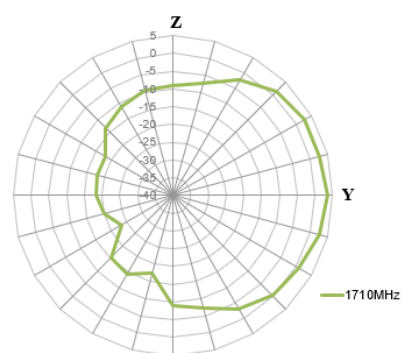
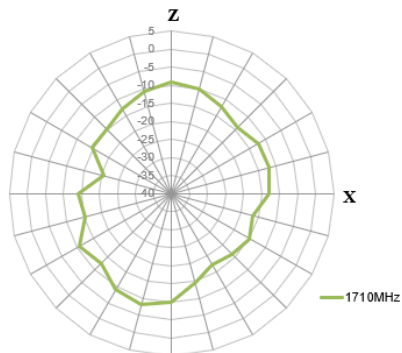
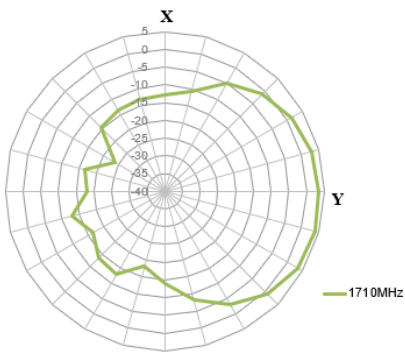

1850MHz

Azimuth = 0.0
 Elevation = 0.0
 Roll = -35.0

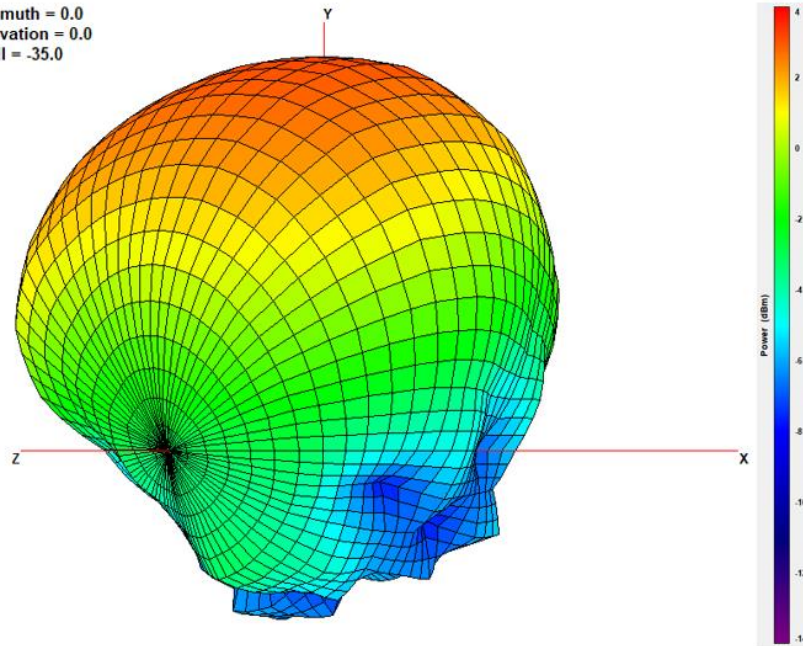

XY Plane

XZ Plane

YZ Plane

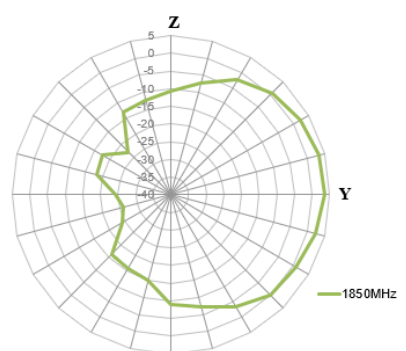
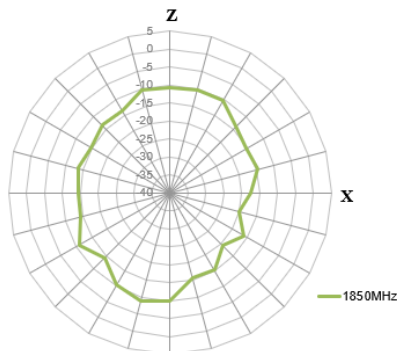
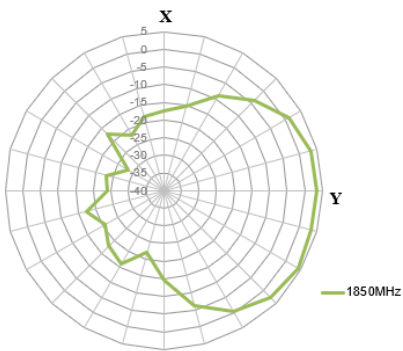

1990MHz

Azimuth = 0.0
Elevation = 0.0
Roll = -35.0

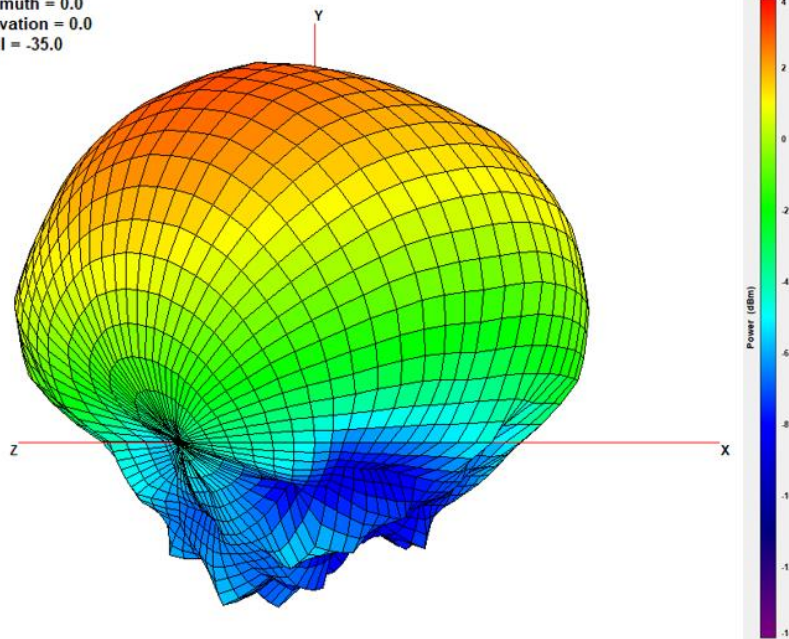

XY Plane

XZ Plane

YZ Plane

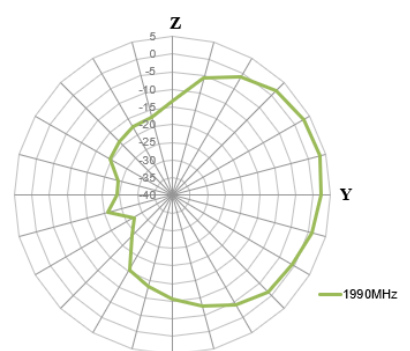
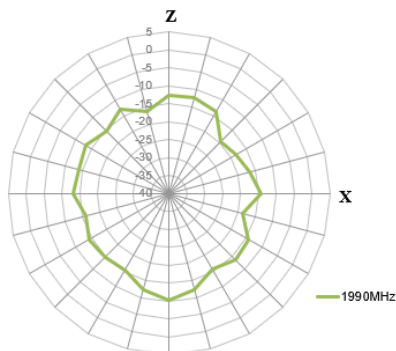
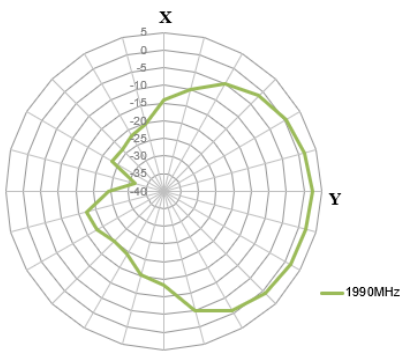

2170MHz

Azimuth = 0.0
Elevation = 0.0
Roll = -35.0

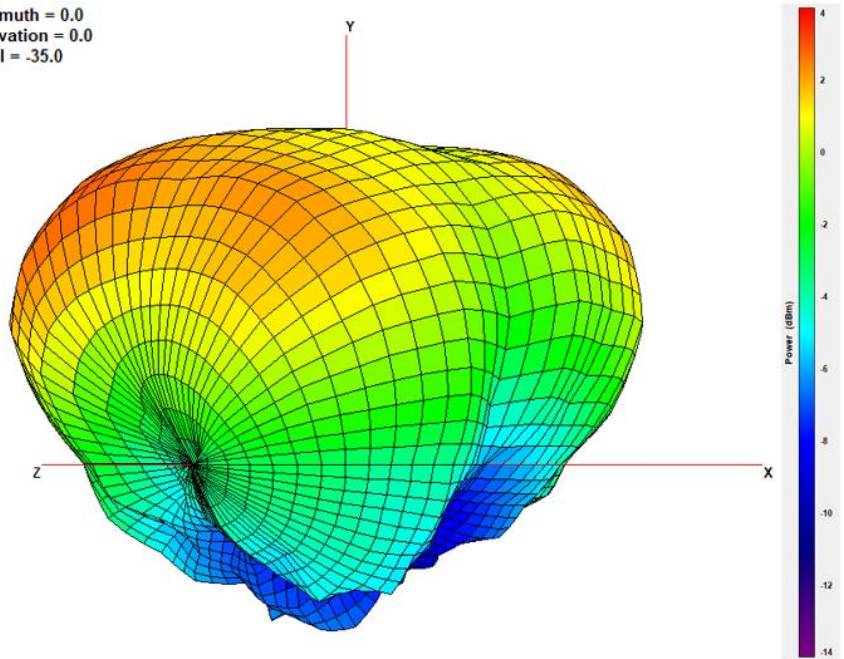

XY Plane

XZ Plane

YZ Plane

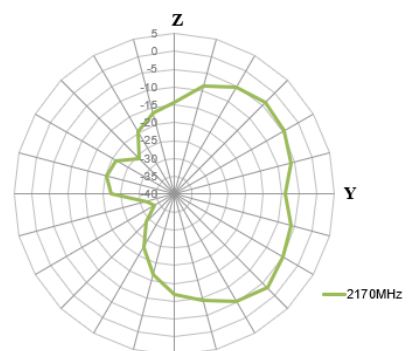
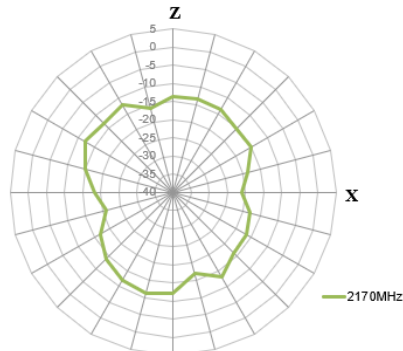
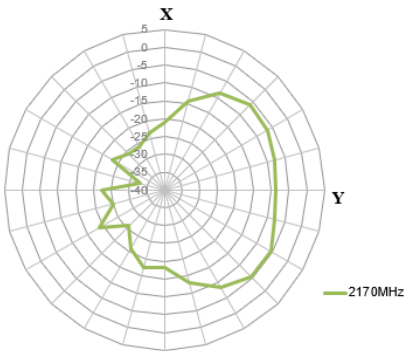

2500MHz

Azimuth = 0.0
Elevation = 0.0
Roll = -35.0

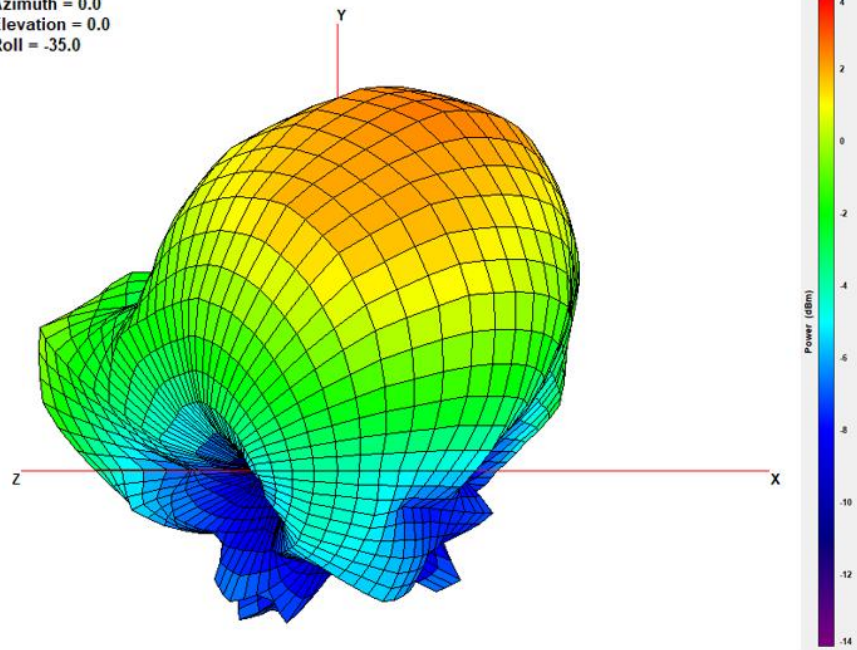

XY Plane

XZ Plane

YZ Plane

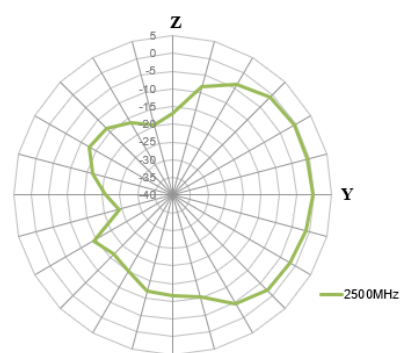
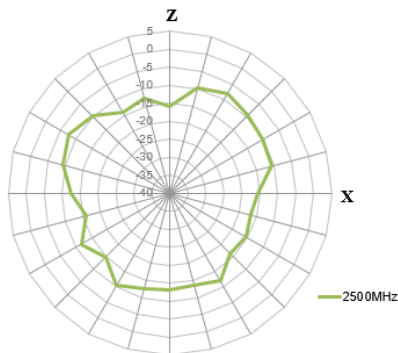
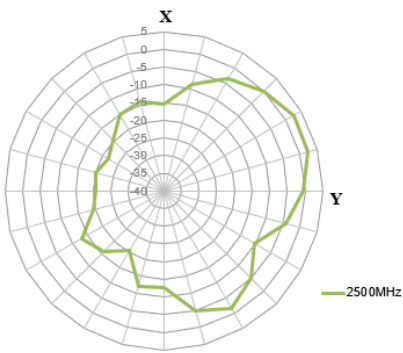

2690MHz

Azimuth = 0.0
Elevation = 0.0
Roll = -35.0

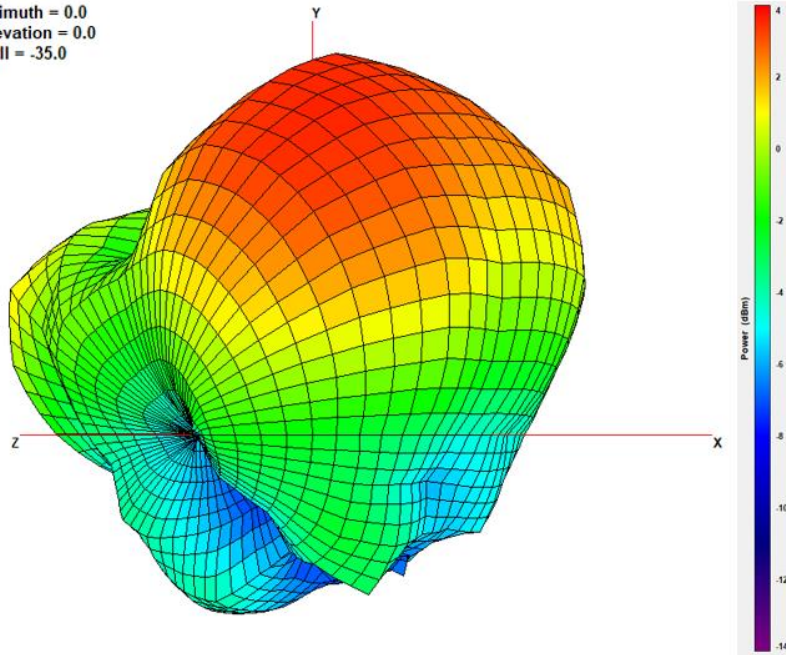

XY Plane

XZ Plane

YZ Plane

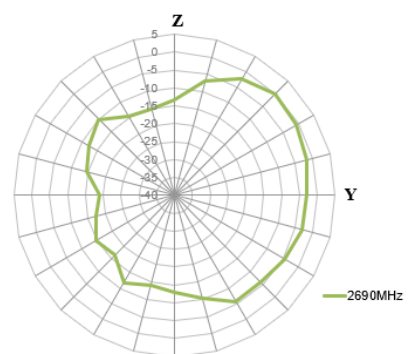
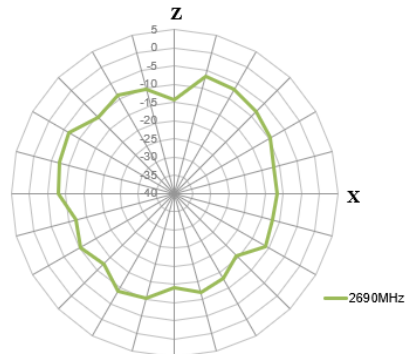
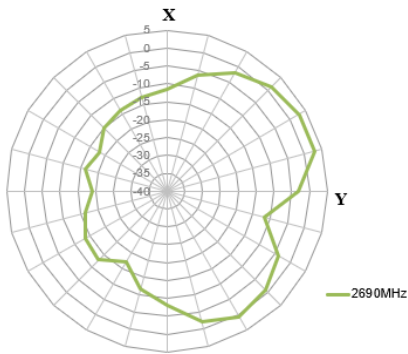

3300MHz

Azimuth = 0.0
Elevation = 0.0
Roll = -35.0

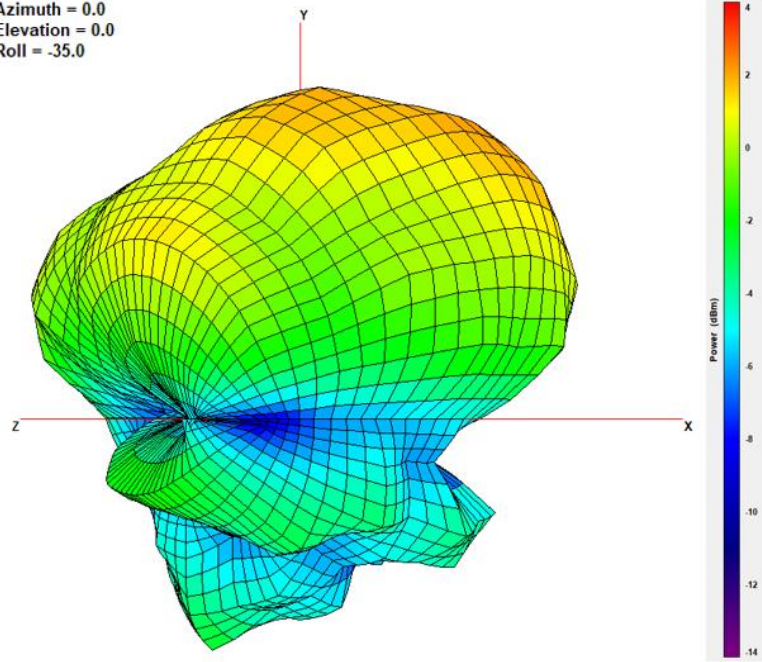

XY Plane

XZ Plane

YZ Plane

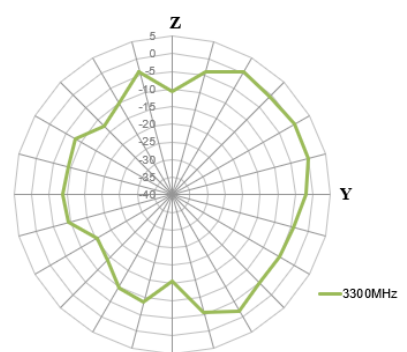
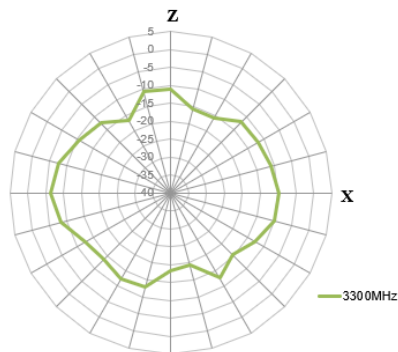
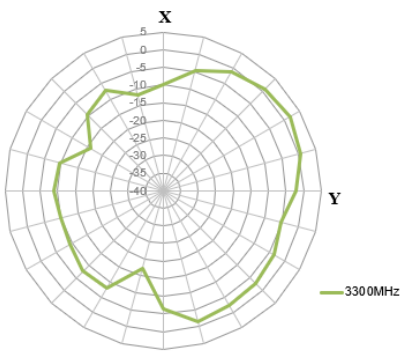

3500MHz

Azimuth = 0.0
Elevation = 0.0
Roll = -35.0

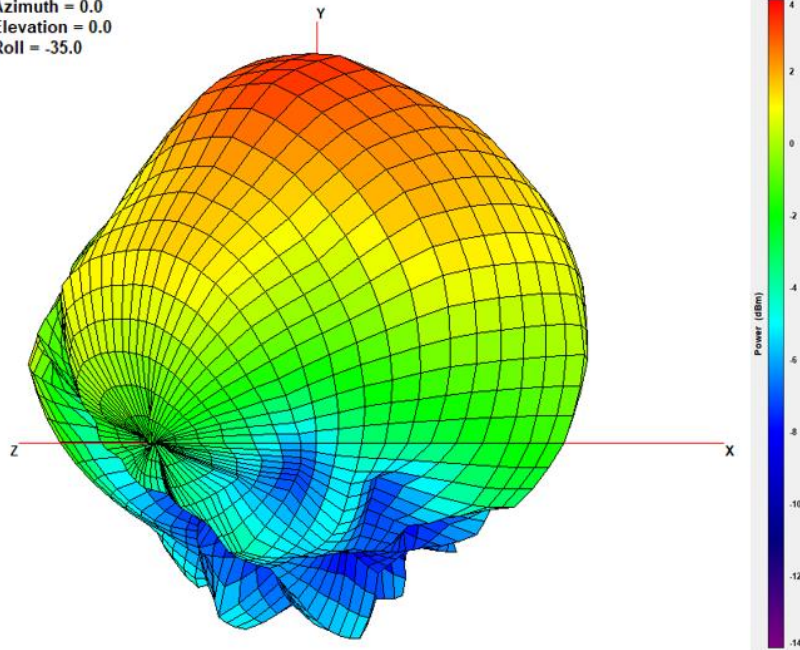

XY Plane

XZ Plane

YZ Plane

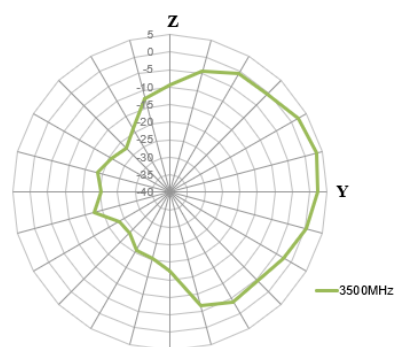
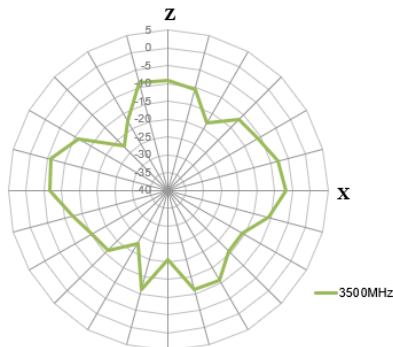
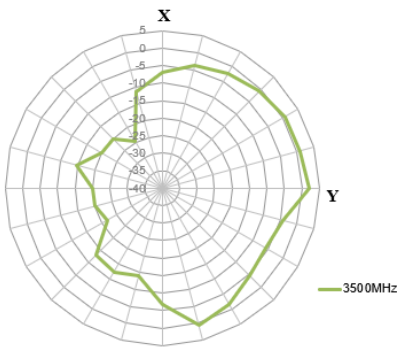

5. Mechanical Drawing (Units: mm)

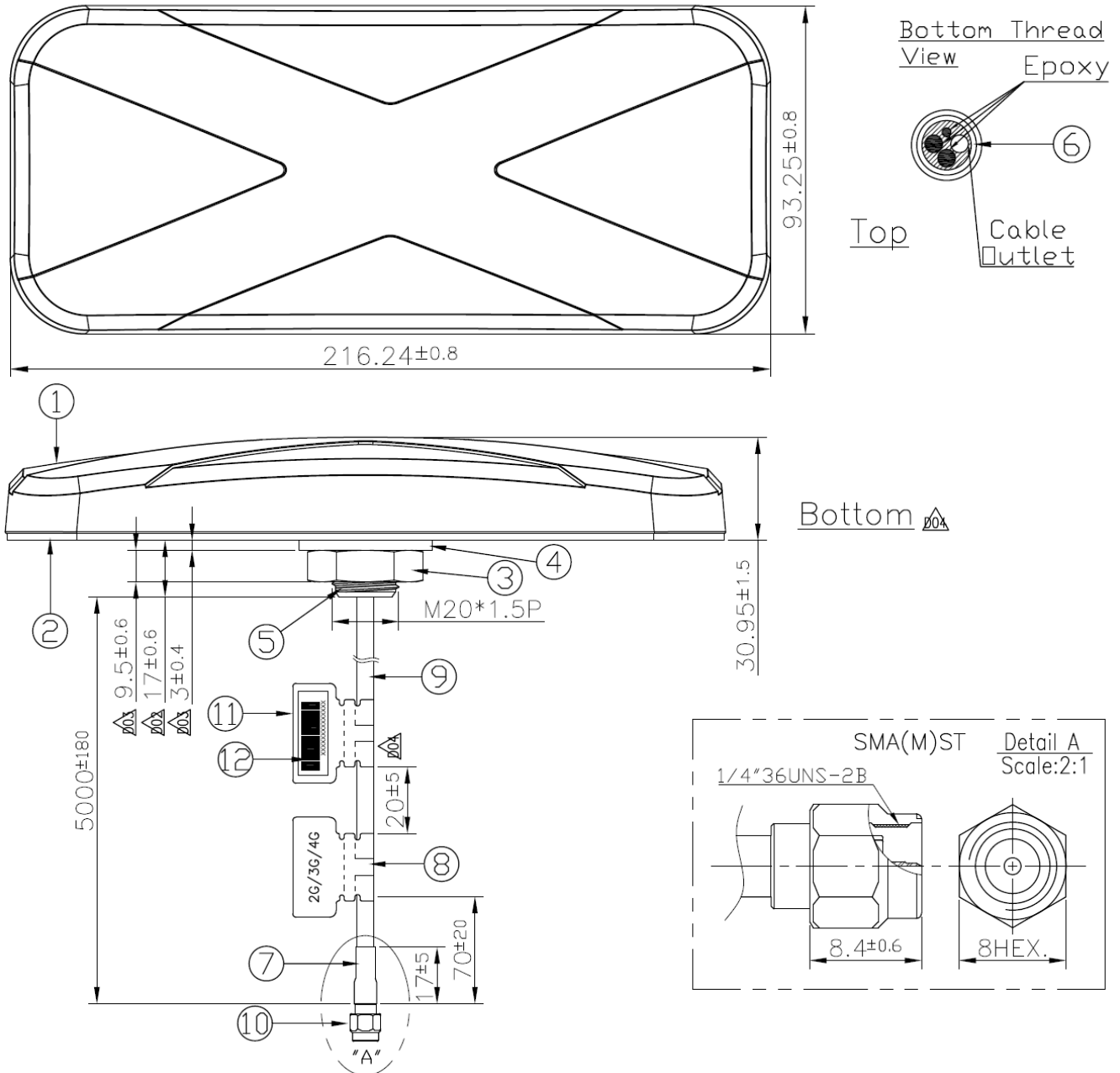

	Name	P/N	Material	Finish	QTY
1	Housing	000113K000066A	ABS+PC	Black	1
2	Closed Cell Foam	001013K000039A	3M 9448+CR-4305	Black	1
3	Nut_M20x1.5Px10H Cut	000413E030061A	Steel	Ni Plated	1
4	Washer_Cut	000413E040061A	Steel	Ni Plated	1
5	Metal Base	000313K000060A	AL	Ni Plated	1
6	Cable Rubber	000713E000063A	Silicone Rubber	Black	1
7	Heat Shrink Tube	001315C030000A	PE	Black	1
8	2G/3G/4G Label	001014C020051A	Coated Paper	White	1
9	CFD200 Coaxial Cable	301415C010000A	PVC	Black	1
10	SMA(M)ST	200211G010013A	Brass	Au Plated	1
11	Empty Label	001015G000000A	PET	White	1
12	Barcode Label	001015G010000A	PET	White	1

6. Installation

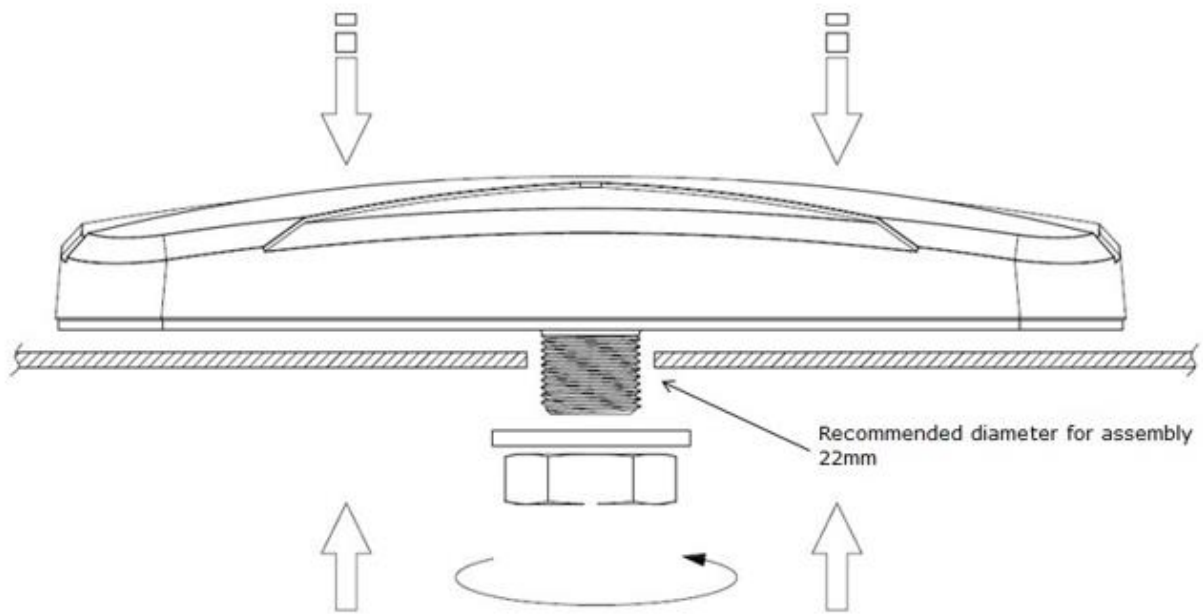

Recommended torque for mounting: 5-7Nm
(Torque value obtained with antenna mounted on 1mm thick SUS-316 bracket)

7. Packaging

MA413.A.B.004

Packaging Specifications

2 pc MA413.A.B.004 per carton
 Carton Dimensions – 390*260*350mm
 Total Weight – 1.56Kg

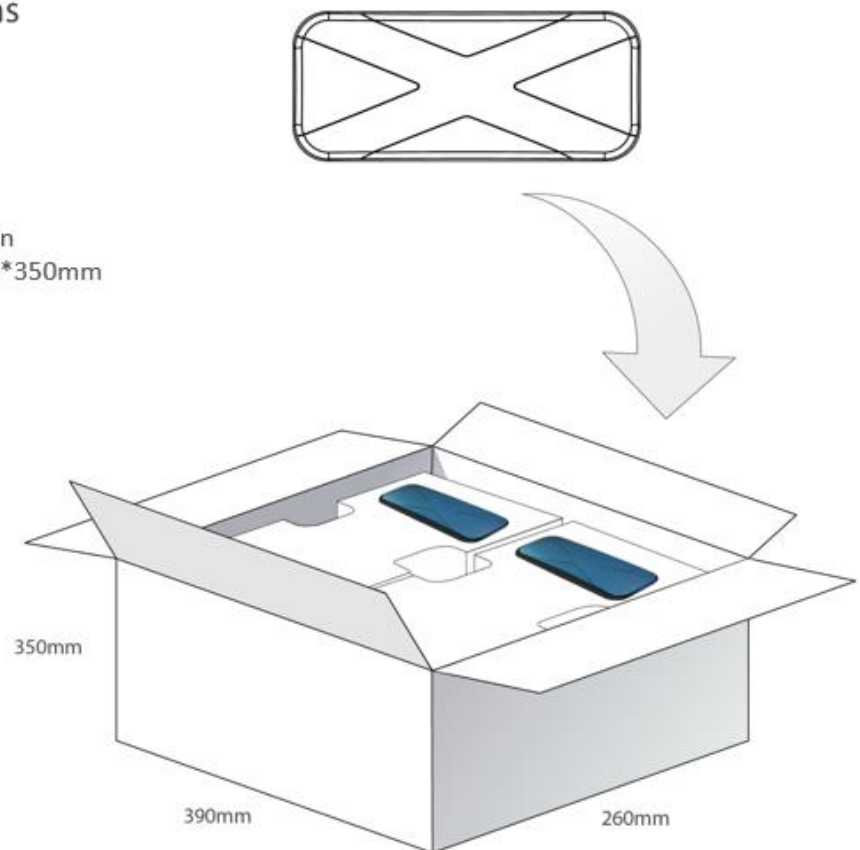

Pallet Dimensions 1180*900*1410mm
 54 Cartons per pallet
 9 Cartons per layer
 6 Layers

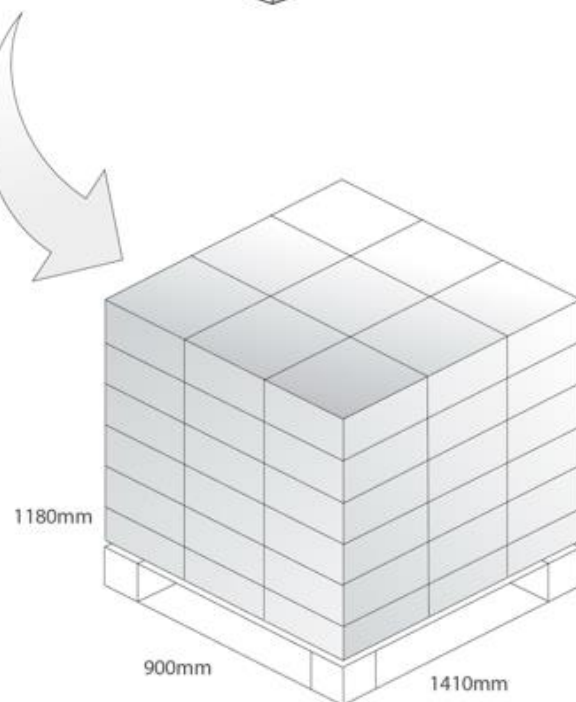

Changelog for the datasheet

SPE-16-8-014 – MA413.A.B.002

Revision: D (Current Version)

Date:	2021-12-16
Changes:	Updated RF data and datasheet template.
Changes Made by:	Gary West

Previous Revisions

Revision: C

Date:	2017-03-30
Changes:	Updated Spec with LTE table
Changes Made by:	Andy Mahoney

Revision: B

Date:	2016-11-28
Changes:	Added CE mark as per request by DC
Changes Made by:	Andy Mahoney

Revision: A (Original First Release)

Date:	2016-03-03
Notes:	
Author:	Technical Writer



www.taoglas.com

