



# TAOGLAS®



# Datasheet

## Steedan

**Part No:**  
MA352.A.LBI.001

### Description:

Steedan 3-in-1 Magnetic Mount Combination Antenna with  
GNSS & 2\*5G/4G MIMO

### Features:

Low Profile Magnetic Mount Enclosure  
2\* 5G/4G MIMO 600-6000MHz  
1\* GPS-GLONASS-Galileo-BeiDou Antenna  
IP65 Rated, Ruggedized PC/ABS Enclosure  
LTE: 3m TGC200 Cable and SMA(M)ST Connector  
GNSS: 3m RG-174 Cable and SMA(M)ST Connector  
Dimensions: 247 \* 144.3 \* 47.8 mm  
RoHS & Reach Compliant

1. Introduction	3
2. Specifications	4
3. Antenna Characteristics	8
4. Radiation Patterns	15
5. Active Antenna Characteristics	37
6. Mechanical Drawing	39
7. Packaging	40
8. Application Note	41
<hr/>	
Changelog	50

Taoglas makes no warranties based on the accuracy or completeness of the contents of this document and reserves the right to make changes to specifications and product descriptions at any time without notice. Taoglas reserves all rights to this document and the information contained herein. Reproduction, use or disclosure to third parties without express permission is strictly prohibited.



# 1. Introduction



The Taoglas Steedan MA352 is a 3-in-1 next-generation low profile magnetic mount antenna for vehicle, outdoor building and heavy equipment roof applications. It has a fully IP65 rated waterproof robust ABS enclosure and base. This is an ideal external combination antenna solution that is used where drilling a hole through the roof of a vehicle or a metal panel is not feasible. It can be mounted on steel surfaces and its ultra-strong neodymium magnets. A soft foam cushion on the base protects the mounting surface during installation and removal. Only 48mm high it mounts discretely to the target application out of sight of most onlookers.

This outstanding antenna delivers powerful MIMO antenna technology 5G/4G and a custom tuned GPS/GLONASS/BeiDou patch antenna for GNSS location services. The 3 internal antennas have superior isolation. The 5G/4G antennas also include backward compatibility to work at most worldwide 3G and 2G bands.

#### Typical Applications:

- Next Generation OEM Automotive Connectivity
- Multimedia, Navigation and Telematics Systems
- V2V, V2X and Fleet Management Applications
- First Net Responder Routers

The MA352 is ideal for applications that require highly sophisticated antennas for real-time streaming applications that demand high-speed video uplink and downlink into the cabin of the vehicle. These challenges are resolved by the highly efficient, high gain MIMO antennas, with high isolation, all of which is necessary to achieve the required signal to noise ratio and throughput.

The MA352 can also be customized for your particular wireless application and frequency band, subject to NRE and MOQ. There are 2x 3000mm low loss TGC-200 cables, terminating in SMA(M) connectors for LTE MIMO. There is a 3000mm RG-174 cable for GNSS terminating in an SMA(M) connector. All cable lengths and connector types are customizable, for further information contact your regional Taoglas customer support team.

## 2. Specifications

GNSS Frequency Bands Covered						
GPS	L1	L2	L5			
	■	■	□			
GLONASS	G1	G2	G3			
	■	■	□			
Galileo	E1	E5a	E5b	E6		
	■	□	■	□		
BeiDou	B1	B2a	B2b	B3		
	■	□	■	□		
QZSS (Regional)	L1	L2C	L5	L6		
	■	■	□	□		
IRNSS (Regional)	L5					
	□					
SBAS	L1/E1/B1	L5/B2a/E5a	G1	G2	G3	
	■	□	■	□	□	

■ GNSS Frequency Bands Covered. □ GNSS Frequency Bands Not Covered.

\*SBAS systems: WASS(L1/L5), EGNOS(E1/E5a), SDCM(G1/G2/G3), SNAS(B1,B2a), GAGAN(L1/L5), QZSS(L1/L5), KAZZ(L1/L5).

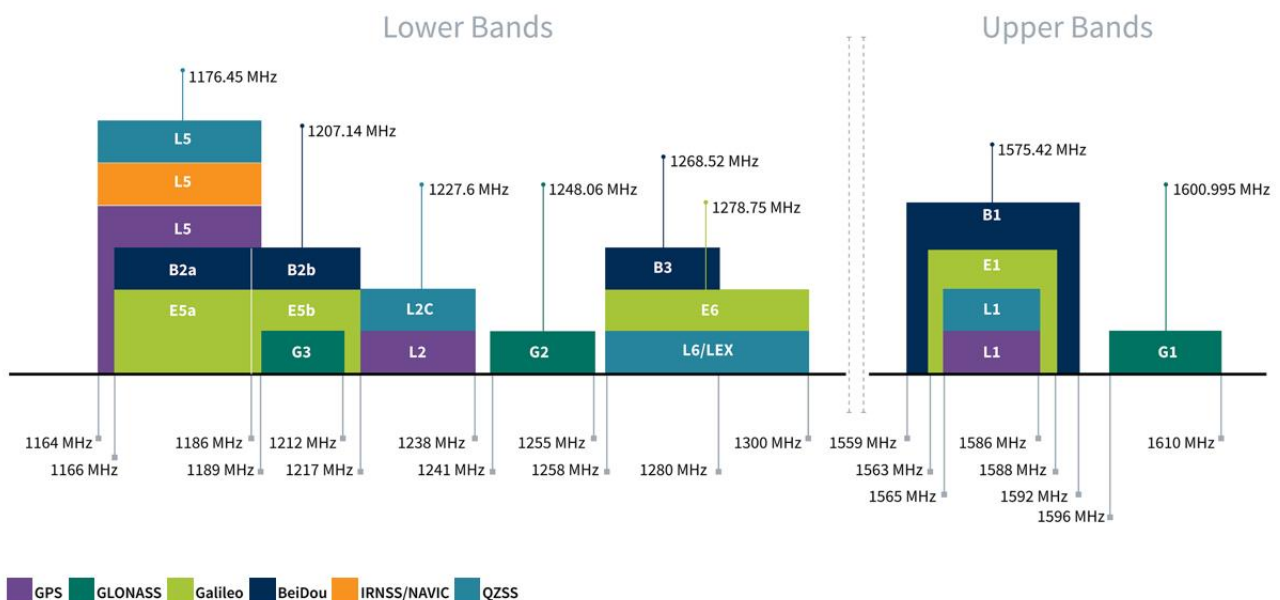

GNSS Bands and Constellations



GNSS Electrical			
Frequency (MHz)	1561	1575.42	1602
Return Loss (dB)	<-10	<-10	<-10
Passive Antenna Gain at Zenith (dBi)	1	1	1
Polarization	RHCP		
Impedance	50Ω		

LNA and Filter Electrical Properties			
Frequency (MHz)	1561	1575.42	1602
Gain@1.8V (Typ.)	25dBic		
Gain@3.0V (Typ.)	30dBic		
Gain@5.5V (Typ.)	32dBic		
Noise@1.8V (Typ.)	2.7dB		
Noise@3.0V (Typ.)	3dB		
Noise@5.5V (Typ.)	3.7dB		
Power consumption@1.8V (Typ.)	6mA		
Power consumption@3.0V (Typ.)	12mA		
Power consumption@5.5V (Typ.)	30mA		

5G/4G MIMO Free Space Electrical									
Band	Frequency (MHz)		Efficiency (%)	Average Gain (dB)	Peak Gain (dBi)	Impedance	Max Input Power	Polarization	Radiation Pattern
5G NR/4G Band 71	617~698	MIMO 1	34.1	-4.7	1.1	50 Ω	10W	Linear	Omni-Directional
		MIMO 2	21.6	-6.7	0.1				
4G/3G Band 12,13,14,17,28,29	698~824	MIMO 1	32.8	-4.8	3				
		MIMO 2	47.1	-3.3	3.5				
4G/3G/NB-IoT/Cat M Band 5,8,18,19,20,26,27	824~960	MIMO 1	39.7	-4	4.2				
		MIMO 2	53.2	-2.7	4				
5G NR/4G Band 21,32,74,75,76	1427~1518	MIMO 1	43.2	-3.7	3.1				
		MIMO 2	54.1	-2.7	3.6				
4G/3G Band 1,2,3,4,9,23,25,35,39,66	1710~2200	MIMO 1	46.8	-3.3	5.5				
		MIMO 2	38.5	-4.1	5				
4G/3G Band 7,38,40,41	2300~2690	MIMO 1	41.7	-3.8	4.9				
		MIMO 2	39.5	-4	5.7				
5G NR Band 22,42,48,77,78,79	3300~4200	MIMO 1	46	-3.4	3.9				
		MIMO 2	46.4	-3.3	4.8				
LTE5200/Wi-Fi 5800	5150~5925	MIMO 1	23.9	-6.2	1.6				
		MIMO 2	26	-5.8	1.7				

### 5G/4G MIMO 30\*30cm Ground Plane Electrical

Band	Frequency (MHz)		Efficiency (%)	Average Gain (dB)	Peak Gain (dBi)	Impedance	Max Input Power	Polarization	Radiation Pattern
5G NR/4G Band 71	617~698	MIMO 1	33.6	-4.7	1.6	50 Ω	10W	Linear	Omni-Directional
		MIMO 2	22.3	-6.5	-1.6				
4G/3G Band 12,13,14,17,28,29	698~824	MIMO 1	35.3	-4.5	2.3				
		MIMO 2	21.5	-6.7	2.1				
4G/3G/NB-IoT/Cat M Band 5,8,18,19,20,26,27	824~960	MIMO 1	44.8	-3.5	5				
		MIMO 2	34.8	-4.6	4				
5G NR/4G Band 21,32,74,75,76	1427~1518	MIMO 1	26.8	-5.7	3.4				
		MIMO 2	40	-4	5.1				
4G/3G Band 1,2,3,4,9,23,25,35,39,66	1710~2200	MIMO 1	41.8	-3.8	6.6				
		MIMO 2	37.9	-4.2	6				
4G/3G Band 7,38,40,41	2300~2690	MIMO 1	37.9	-4.2	5.9				
		MIMO 2	40.5	-3.9	6.9				
5G NR Band 22,42,48,77,78,79	3300~4200	MIMO 1	44.9	-3.5	5.4				
		MIMO 2	48.1	-3.2	5.9				
LTE5200/ Wi-Fi 5800	5150~5925	MIMO 1	21	-6.8	3				
		MIMO 2	23.5	-6.3	3.3				

### Mechanical

Dimensions	247*144.3*47.78 mm
Weight	550 g
Material	PC+ABS
Connector	LTE: SMA(M) GNSS: SMA(M)
Cable	LTE MIMO: 3000mm TGC200 GNSS: 3000mm RG-174
Sealant	Rubber Stopper

### Environmental

Protection	IP65
Corrosion	5% NaCl for 96hrs - Nickel plated steel base and thread
Temperature Range	-40°C to +85°C
Thermal Shock	100 cycles -40°C to +85°C
Humidity	Non-condensing 65°C 95% RH
Shock (Drop Test)	1m drop on concrete 6 axes
Cable Pull	8 Kgf

5G/4G Bands			
Band Number	5G NR / FR1 / LTE / LTE-Advanced / WCDMA / HSPA / HSPA+ / TD-SCDMA		
	Uplink	Downlink	Covered
1	UL: 1920 to 1980	DL: 2110 to 2170	✓
2	UL: 1850 to 1910	DL: 1930 to 1990	✓
3	UL: 1710 to 1785	DL: 1805 to 1880	✓
4	UL: 1710 to 1755	DL: 2110 to 2155	✓
5	UL: 824 to 849	DL: 869 to 894	✓
7	UL: 2500 to 2570	DL: 2620 to 2690	✓
8	UL: 880 to 915	DL: 925 to 960	✓
9	UL: 1749.9 to 1784.9	DL: 1844.9 to 1879.9	✓
11	UL: 1427.9 to 1447.9	DL: 1475.9 to 1495.9	✓
12	UL: 699 to 716	DL: 729 to 746	✓
13	UL: 777 to 787	DL: 746 to 756	✓
14	UL: 788 to 798	DL: 758 to 768	✓
17	UL: 704 to 716	DL: 734 to 746	✓
18	UL: 815 to 830	DL: 860 to 875	✓
19	UL: 830 to 845	DL: 875 to 890	✓
20	UL: 832 to 862	DL: 791 to 821	✓
21	UL: 1447.9 to 1462.9	DL: 1495.9 to 1510.9	✓
22	UL: 3410 to 3490	DL: 3510 to 3590	✓
23	UL: 2000 to 2020	DL: 2180 to 2200	✓
24	UL: 1625.5 to 1660.5	DL: 1525 to 1559	✓
25	UL: 1850 to 1915	DL: 1930 to 1995	✓
26	UL: 814 to 849	DL: 859 to 894	✓
27	UL: 807 to 824	DL: 852 to 869	✓
28	UL: 703 to 748	DL: 758 to 803	✓
29	UL: -	DL: 717 to 728	✓
30	UL: 2305 to 2315	DL: 2350 to 2360	✓
31	UL: 452.5 to 457.5	DL: 462.5 to 467.5	✗
32	UL: -	DL: 1452 - 1496	✓
35		1850 to 1910	✓
38		2570 to 2620	✓
39		1880 to 1920	✓
40		2300 to 2400	✓
41		2496 to 2690	✓
42		3400 to 3600	✓
43		3600 to 3800	✓
48		3550 to 3700	✓
66	UL: 1710-1780	DL: 2110-2200	✓
71		617 to 698	✓
74/75/76		1427 to 1518	✓
78		3300 to 3800	✓
79		4400 to 5000	✓
126		410 to 430	✗

### 3. Antenna Characteristics

#### 3.1 Return Loss - GNSS

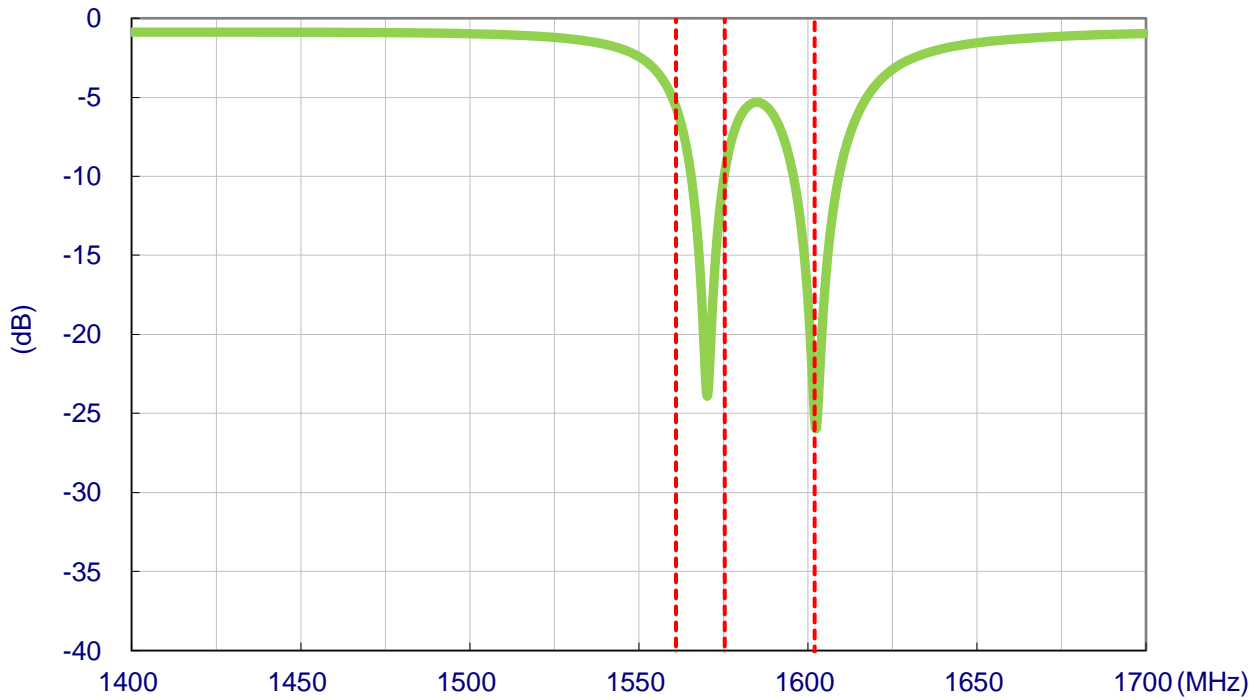

#### 3.2 Return Loss – 5G/4G MIMO Free Space

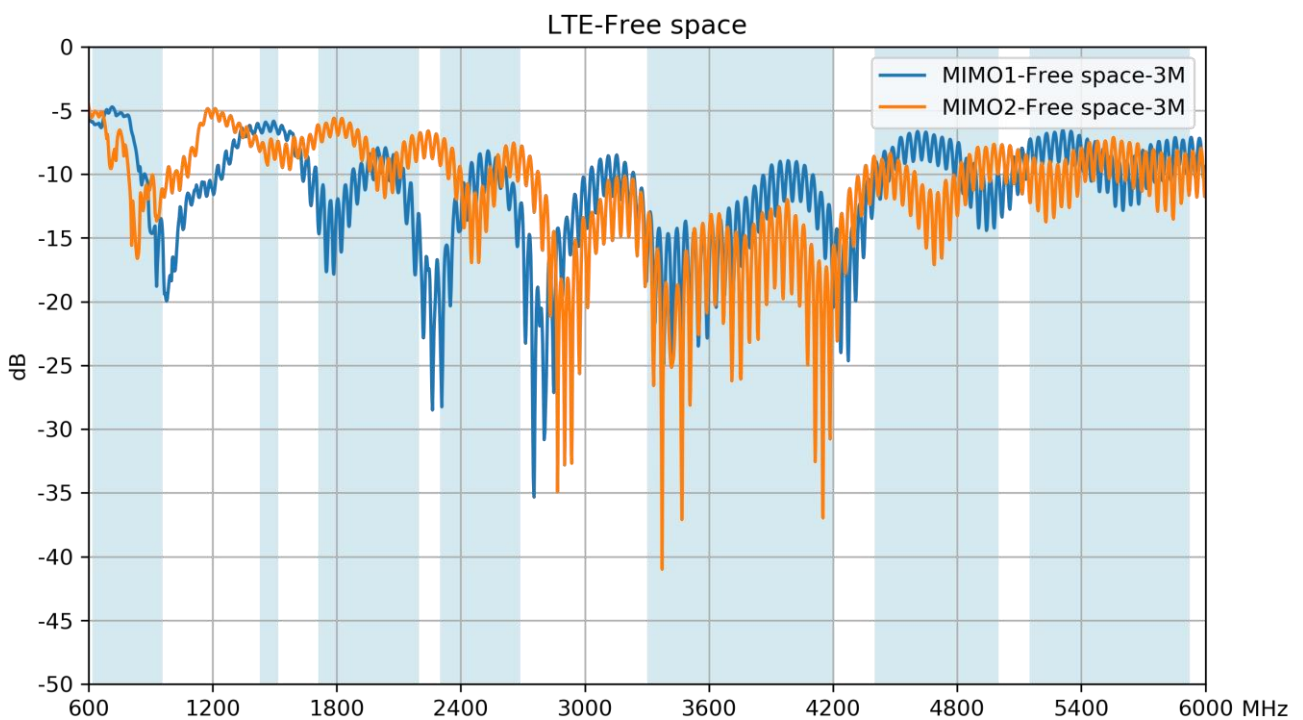

### 3.3 Return Loss – 5G/4G MIMO 30\*30cm Ground Plane

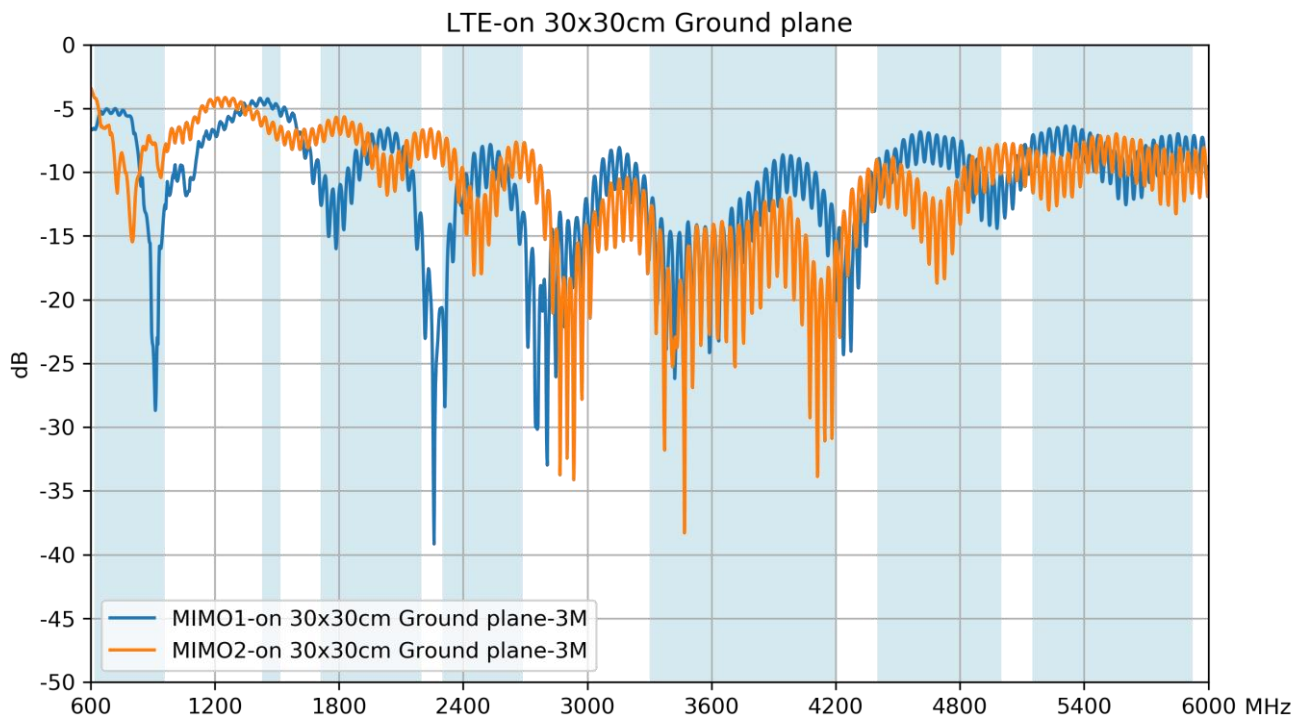

### 3.4 Isolation

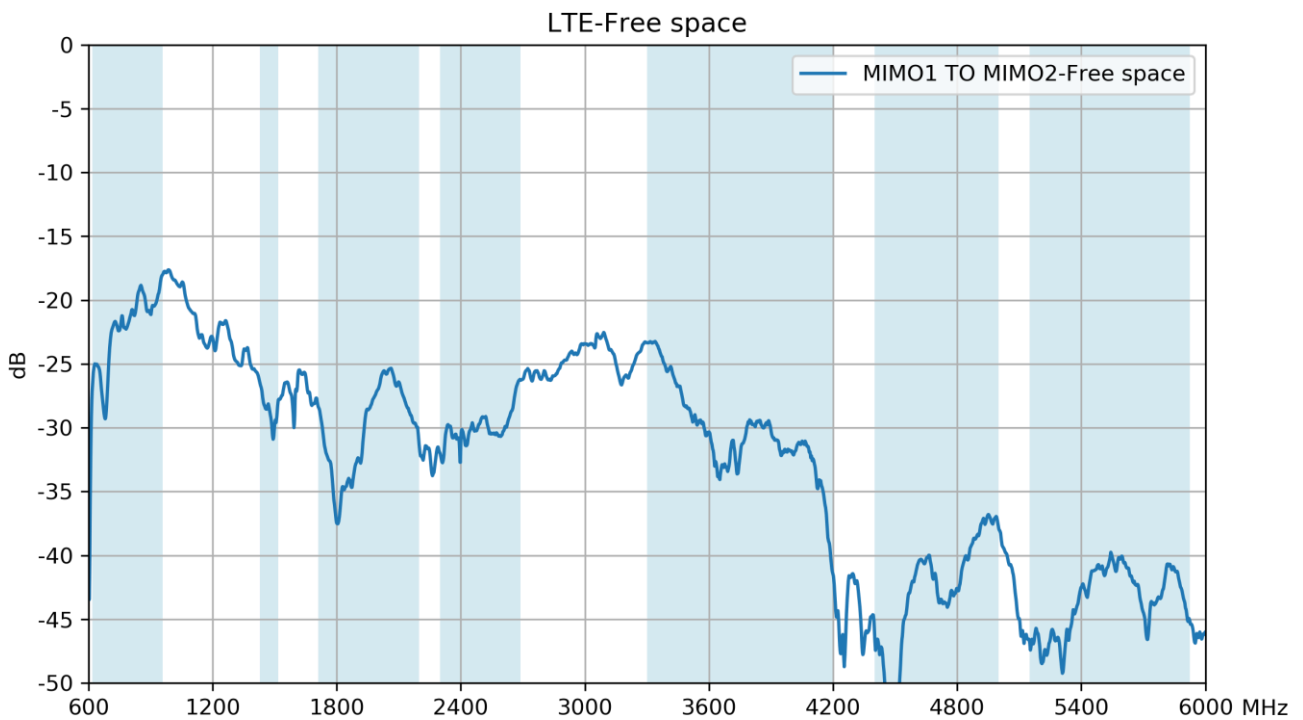

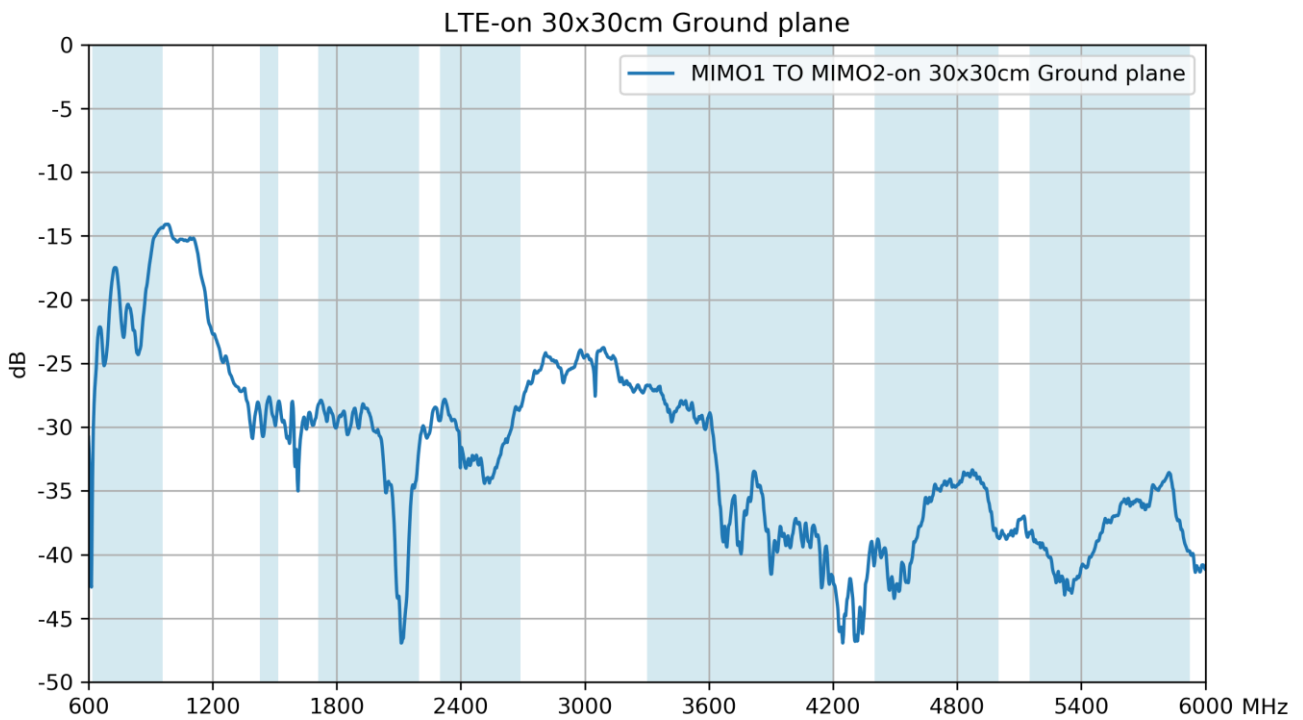

### 3.5 Efficiency – GNSS

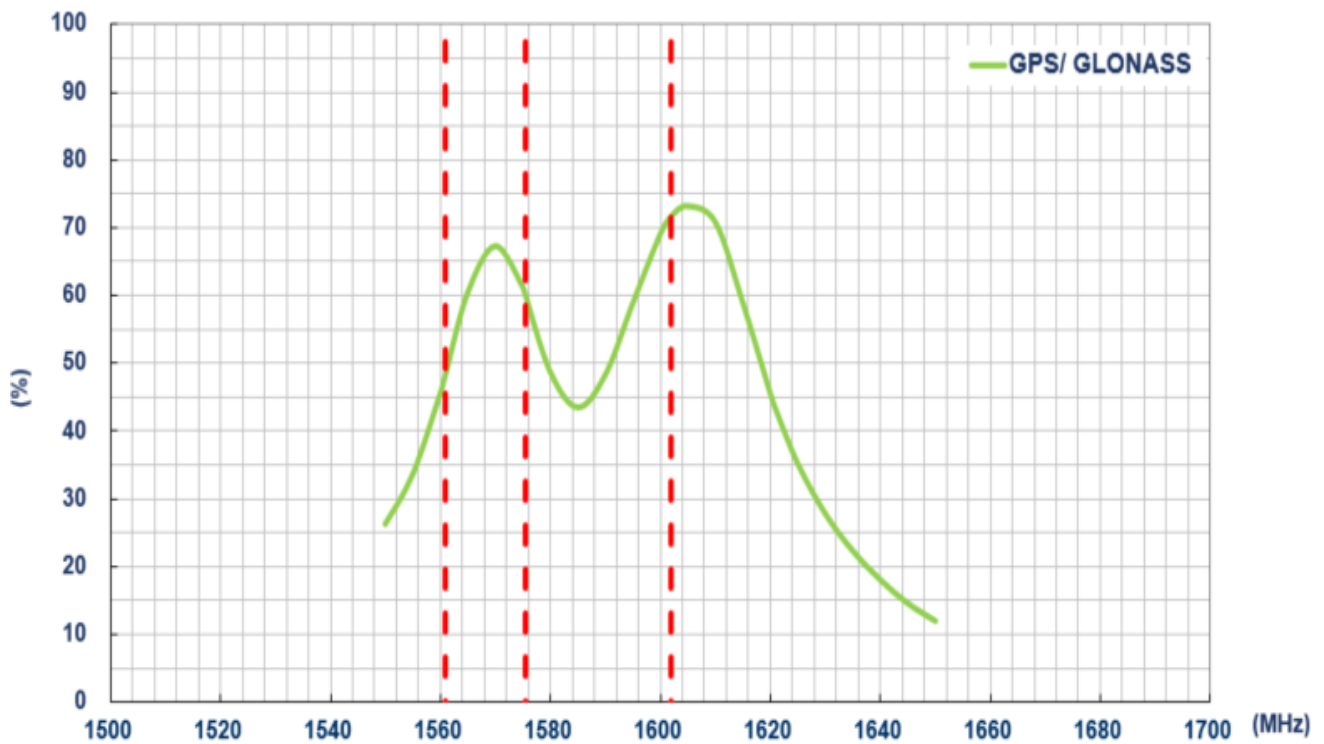

### 3.6 Efficiency – 5G/4G MIMO Free Space

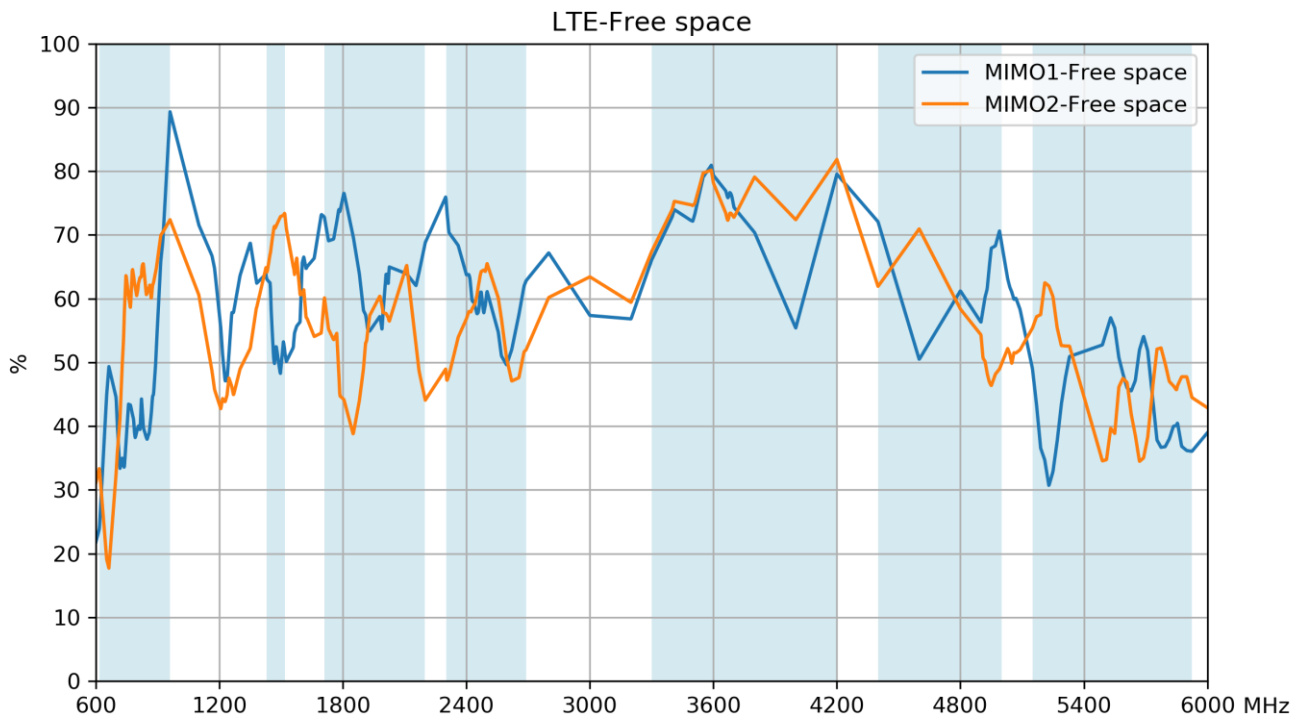

### 3.7 Efficiency – 5G/4G MIMO 30\*30cm Ground Plane

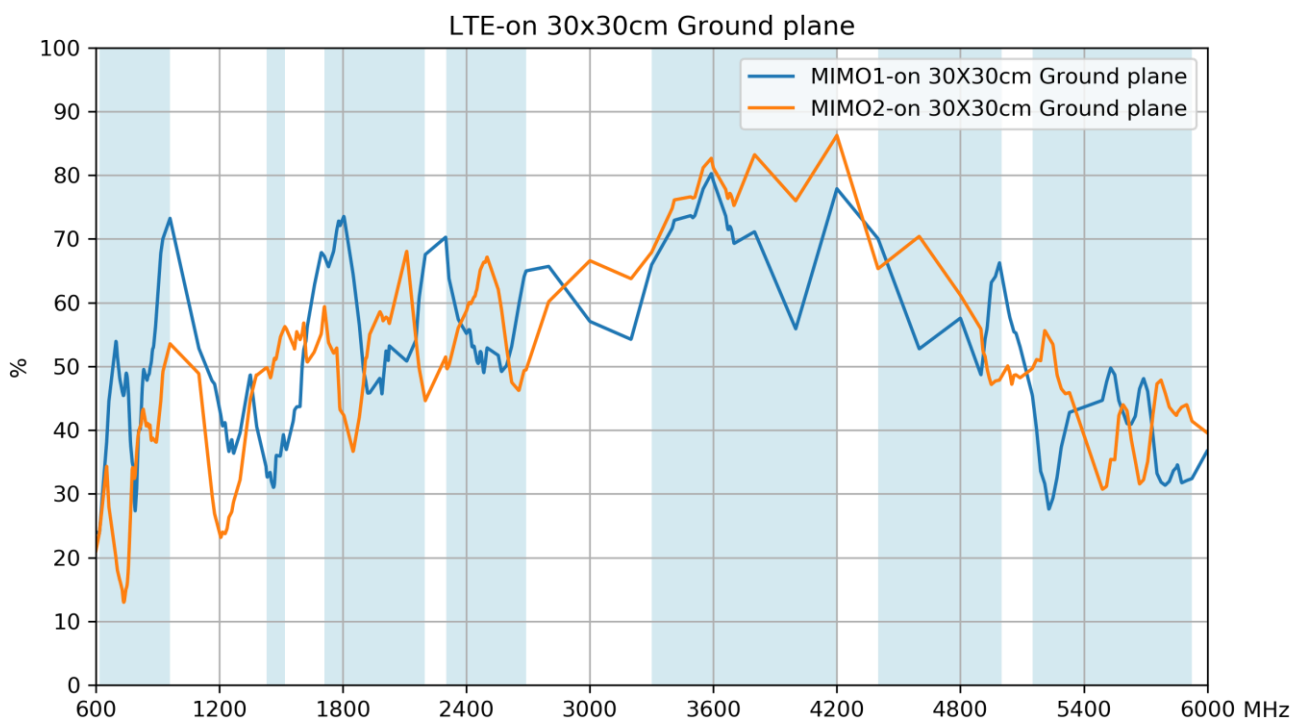



### 3.8 Average Gain – GNSS

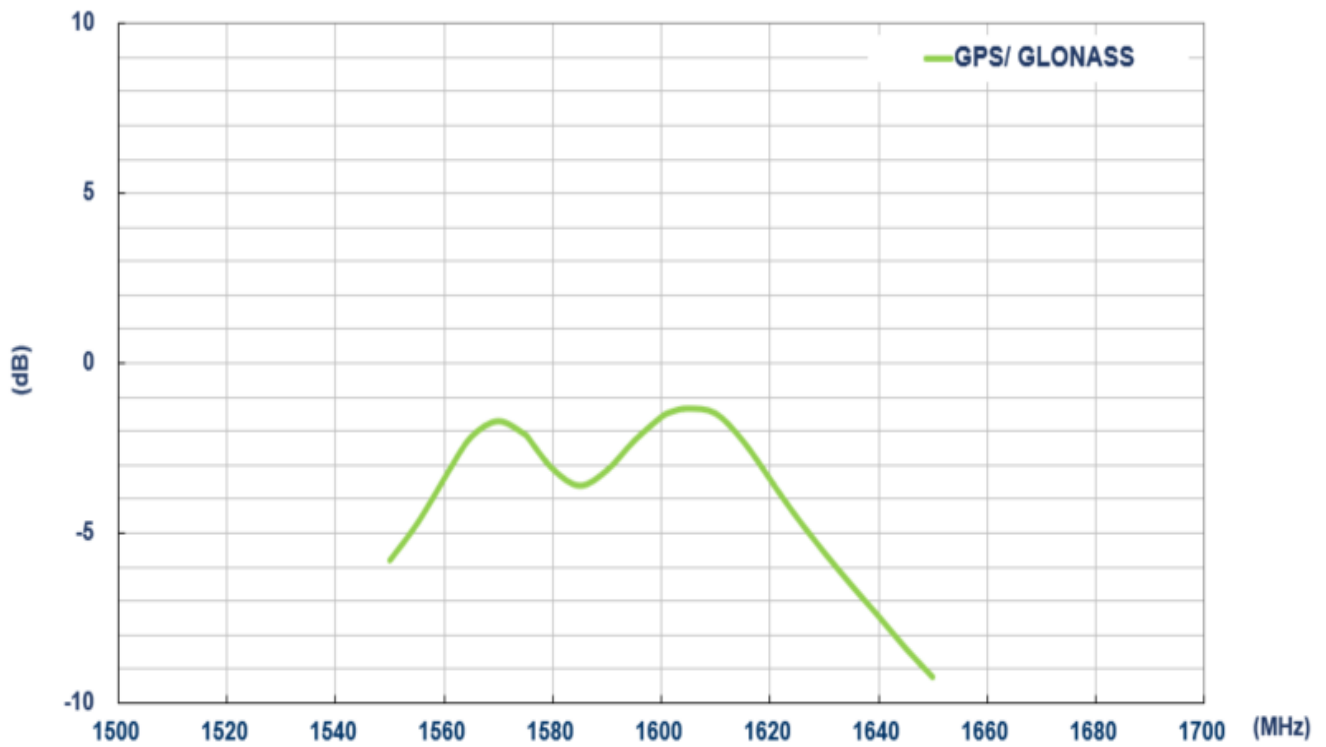

### 3.9 Average Gain – 5G/4G MIMO Free Space

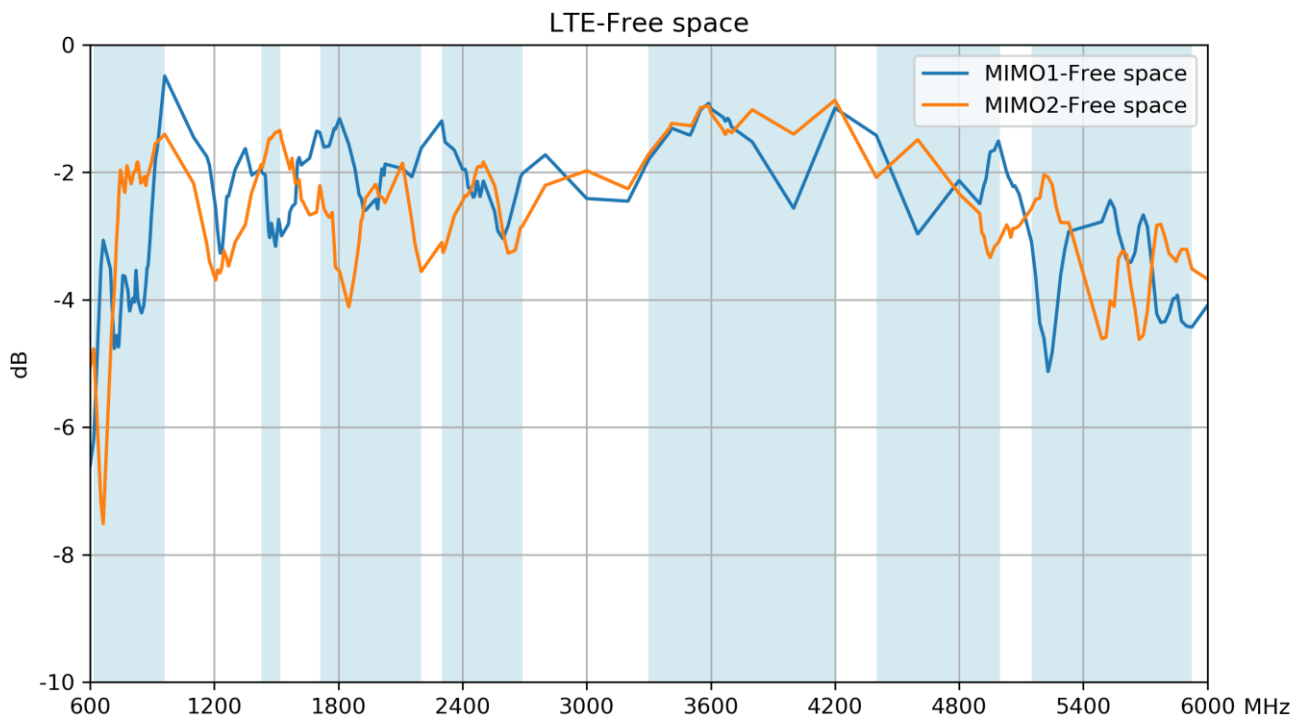

### 3.10 Average Gain – 5G/4G MIMO 30\*30cm Ground Plane

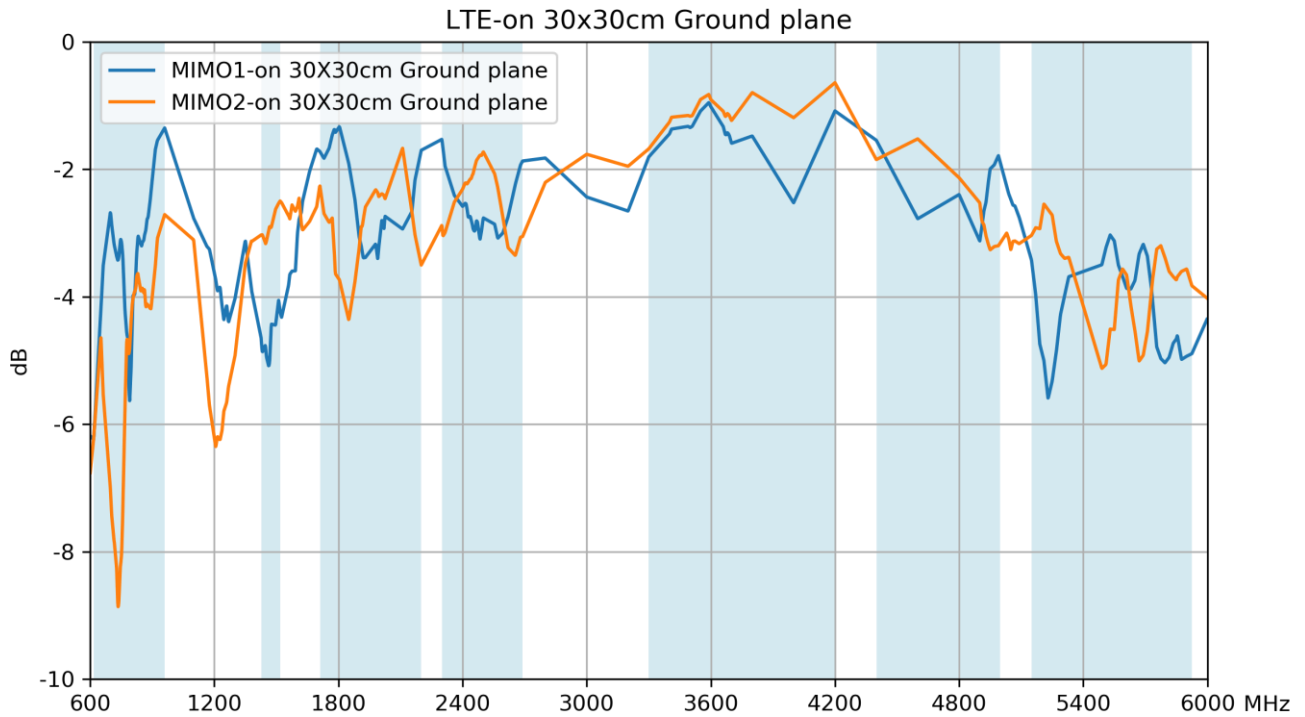

### 3.11 Peak Gain – GNSS

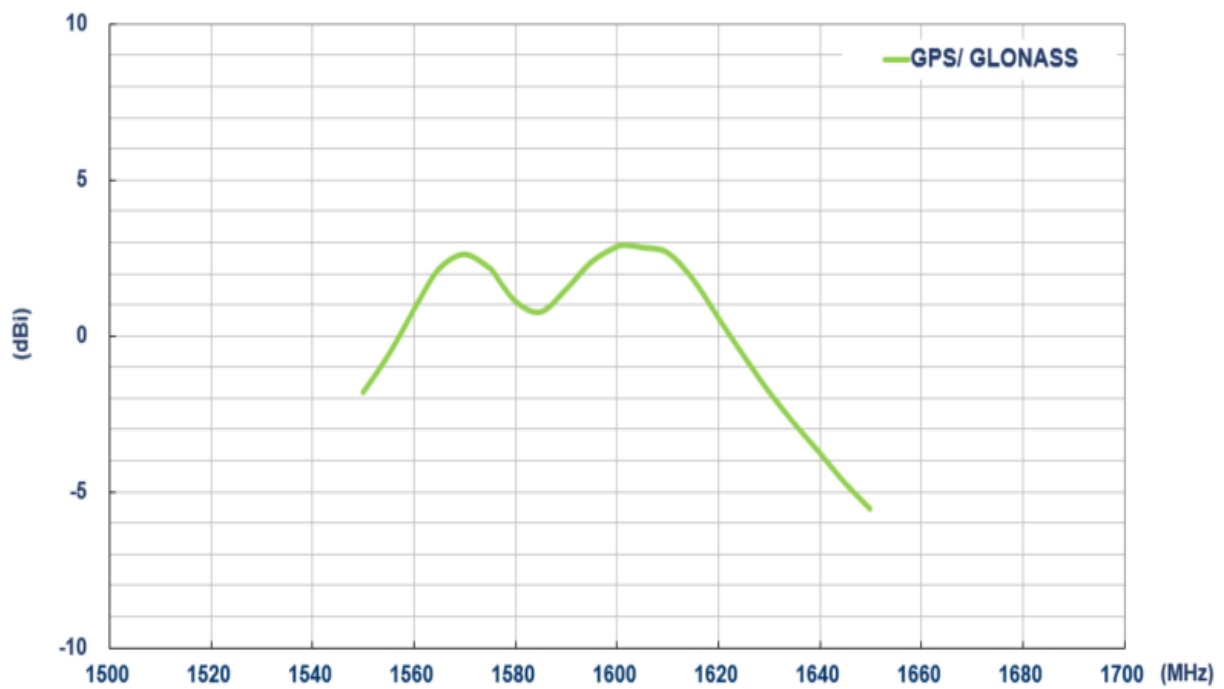

### 3.12 Peak Gain – 5G/4G MIMO Free Space

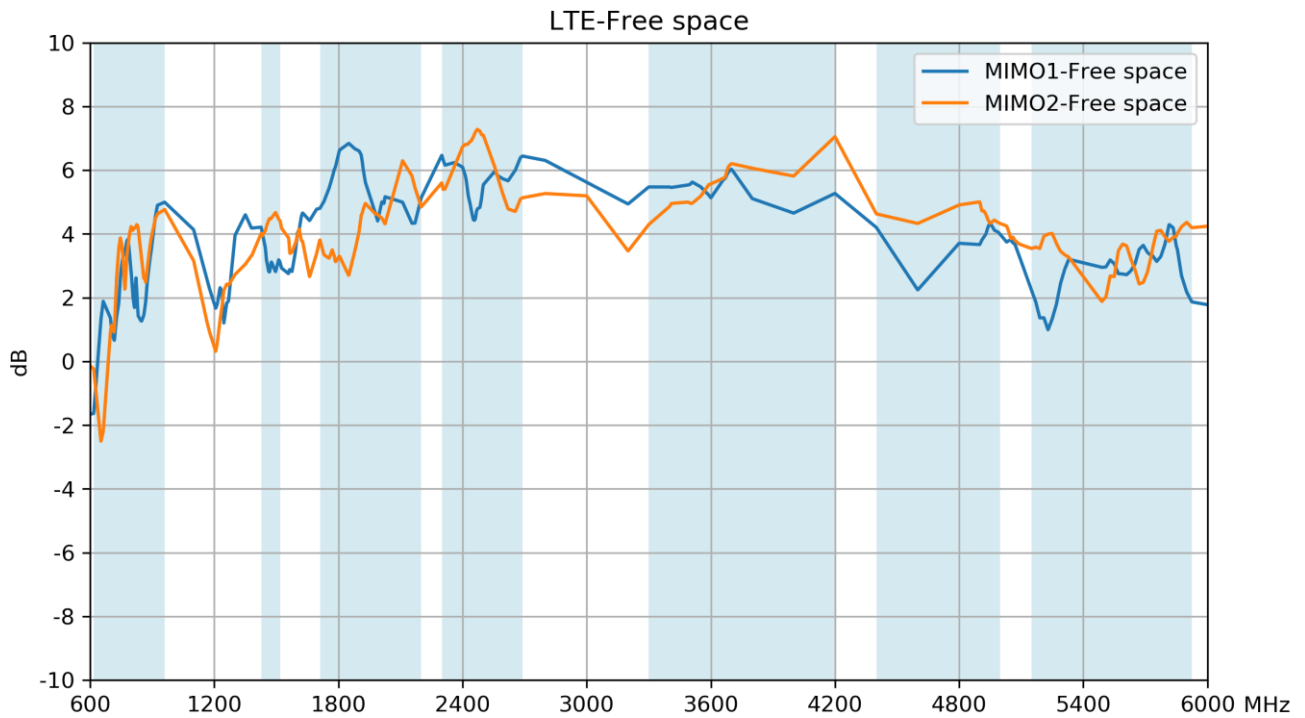

### 3.13 Peak Gain – 5G/4G MIMO 30\*30cm Ground Plane

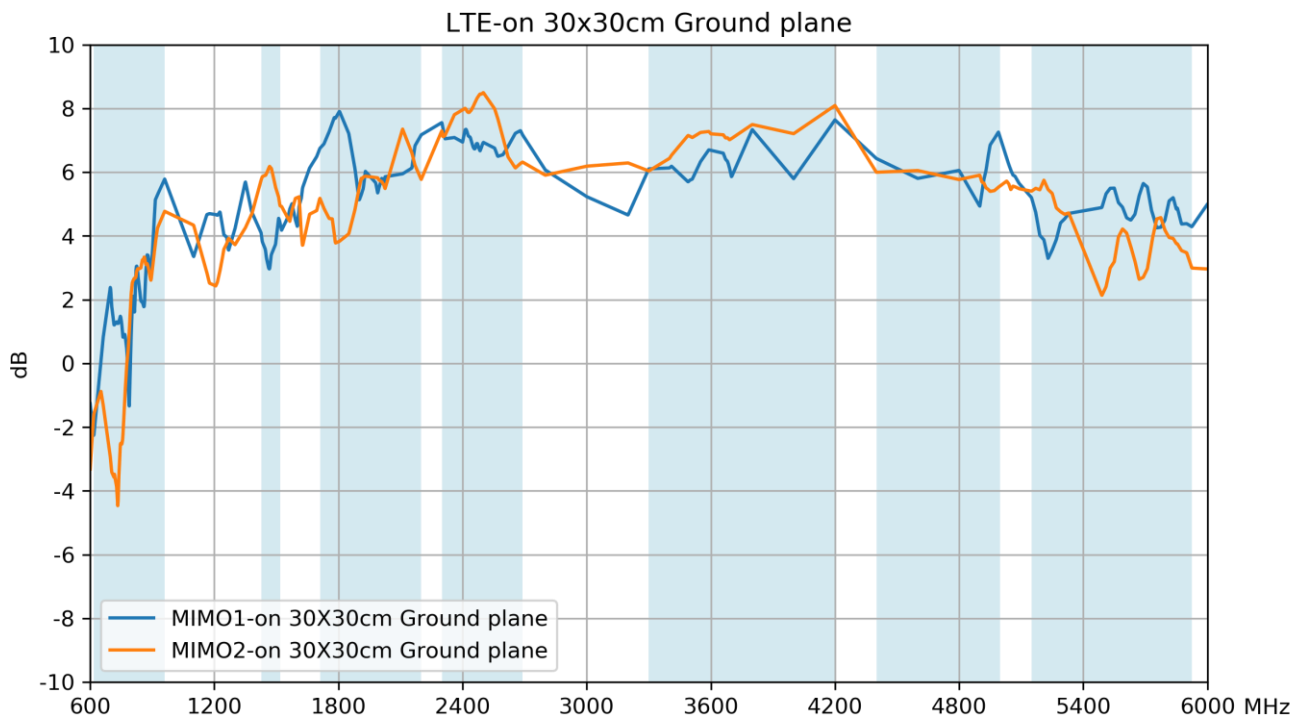

## 4. Radiation Patterns

### 4.1 Test Setup – 30\*30cm Ground Plane

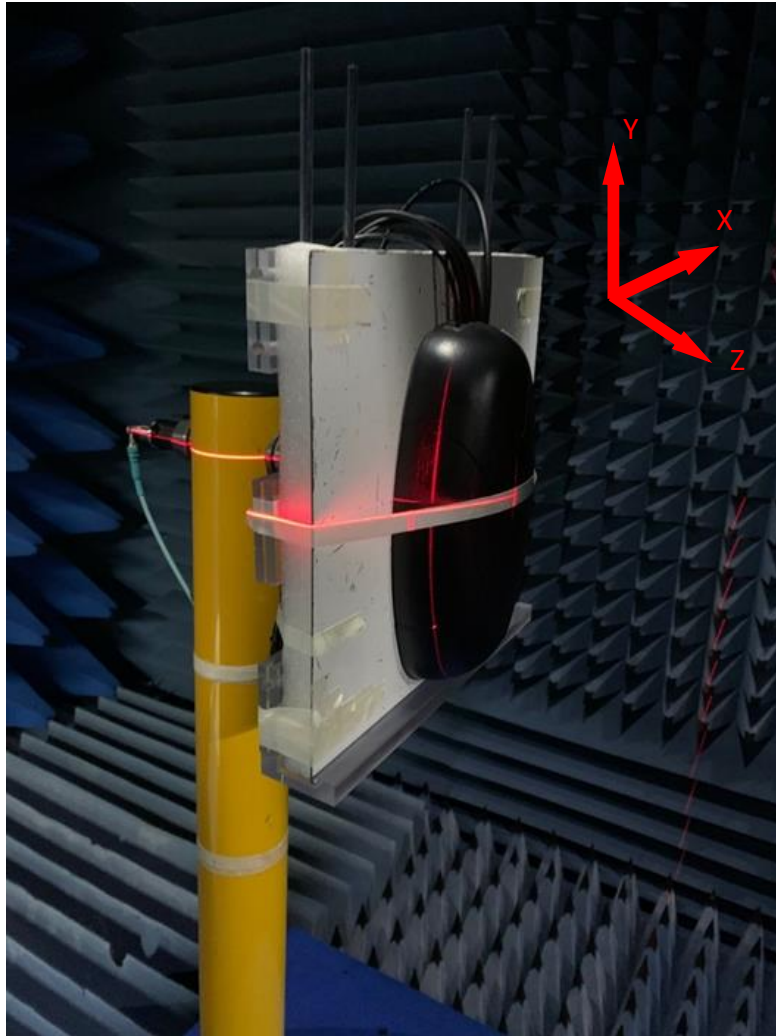

## 4.2 GNSS 3D and 2D Radiation Patterns – 30\*30cm Ground Plane

1575.42MHz

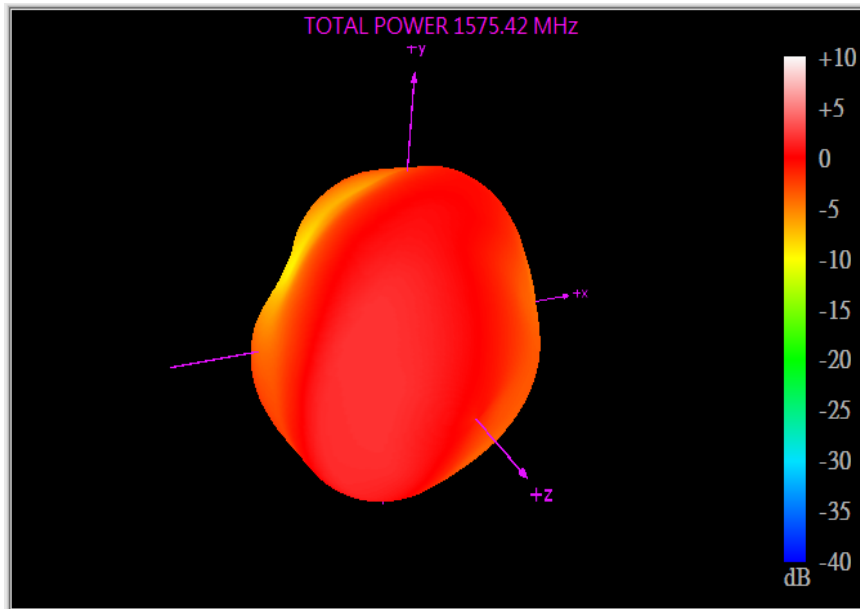

XY Plane

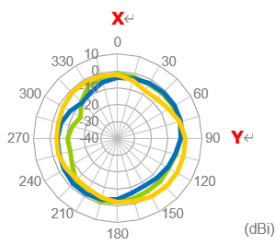

1561MHz  
1575.42MHz  
1602MHz

XZ Plane

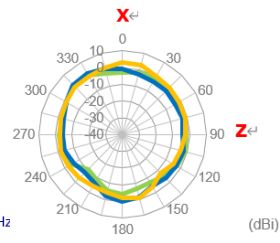

1561MHz  
1575.42MHz  
1602MHz

YZ Plane

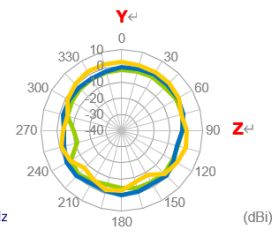

1561MHz  
1575.42MHz  
1602MHz

4.3 5G/4G MIMO 1 3D and 2D Radiation Patterns – 30\*30cm Ground Plane

652MHz

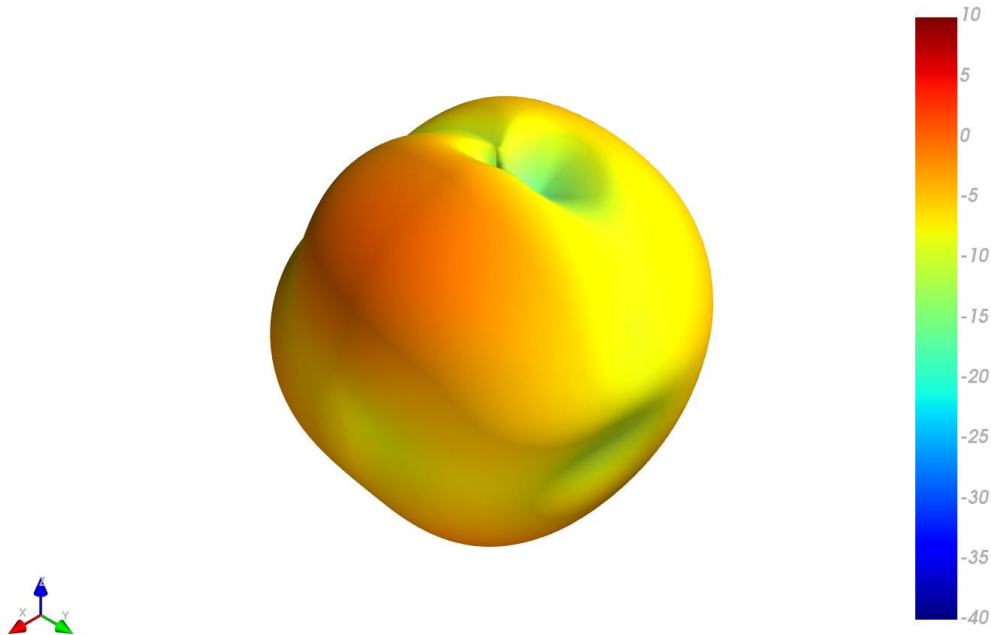

XY Plane

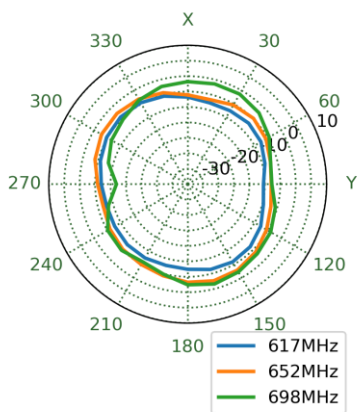

XZ Plane

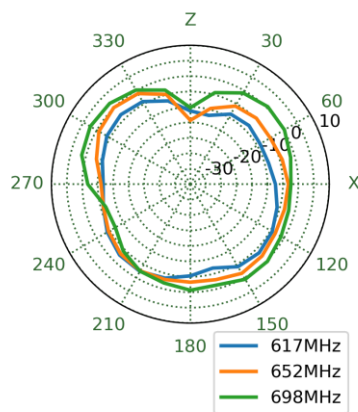

YZ Plane

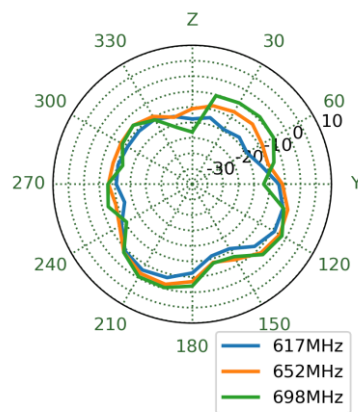

751MHz

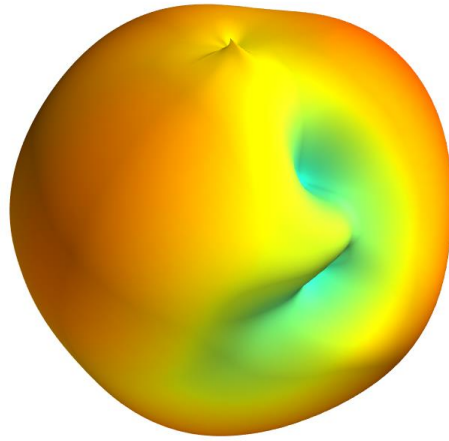

XY Plane

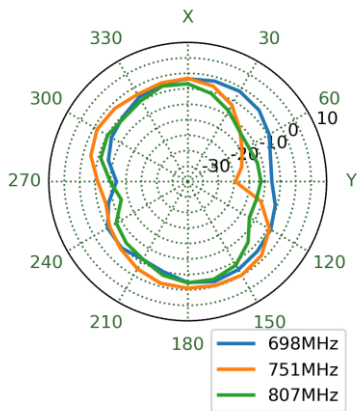

XZ Plane

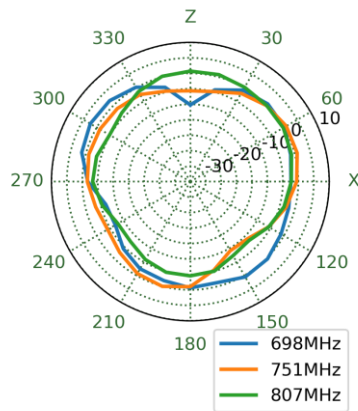

YZ Plane

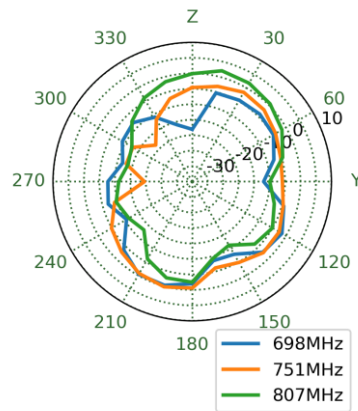



890MHz

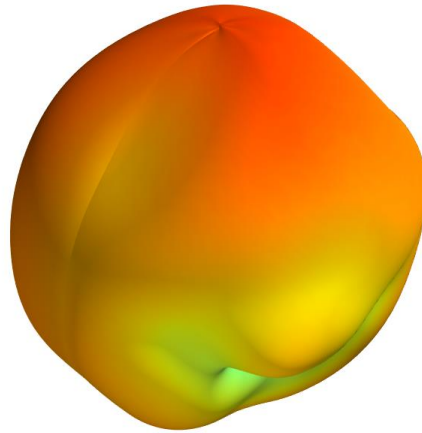

XY Plane

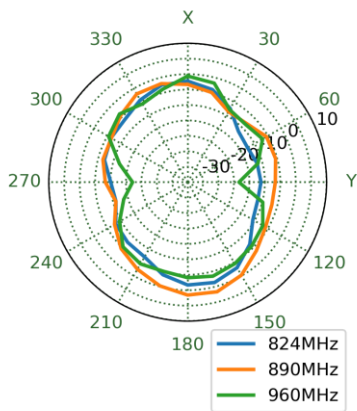

XZ Plane

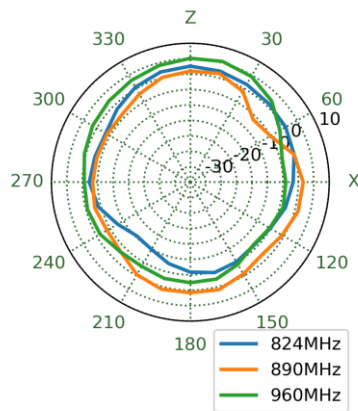

YZ Plane

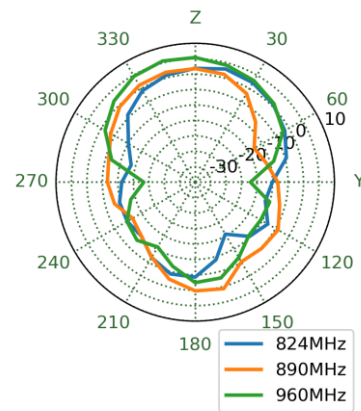

1470MHz

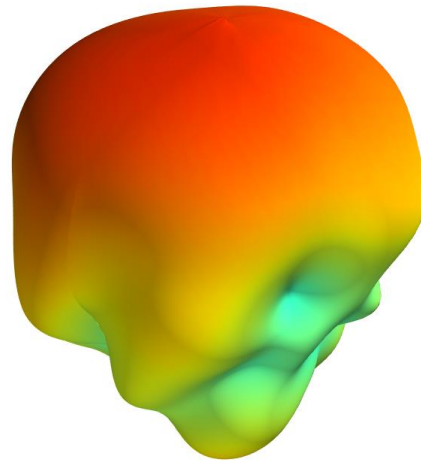

XY Plane

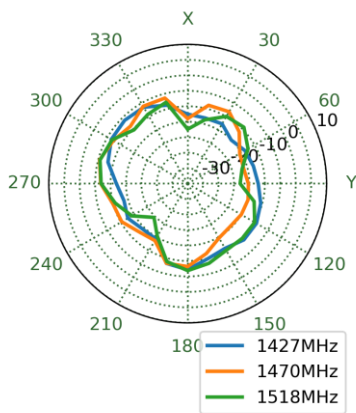

XZ Plane

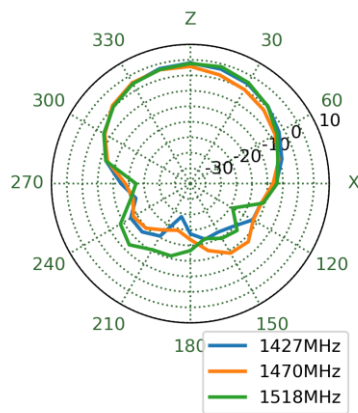

YZ Plane

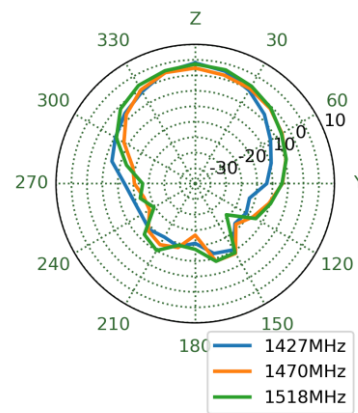

1805MHz

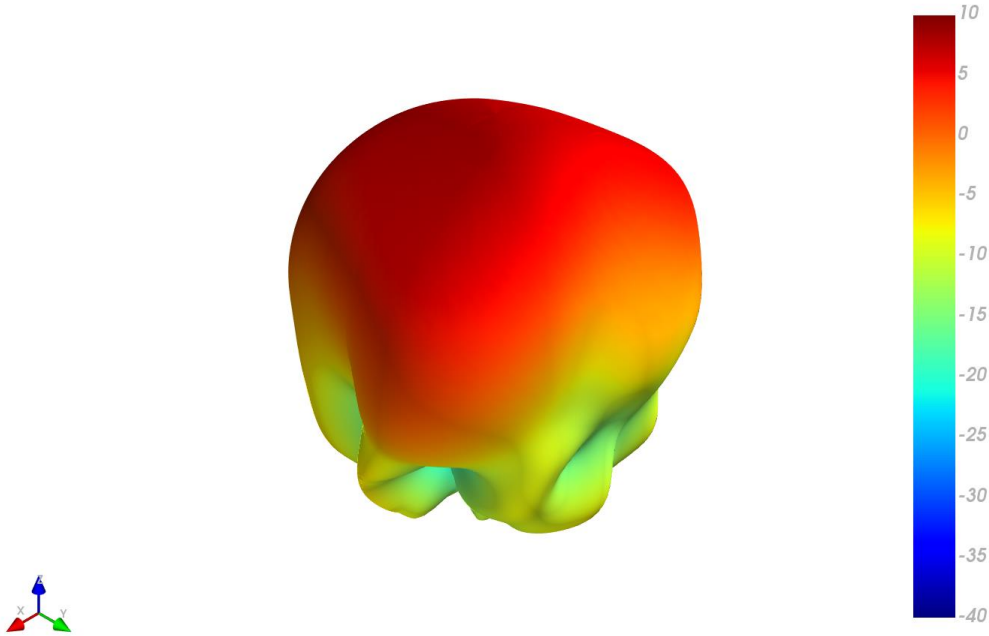

XY Plane

XZ Plane

YZ Plane

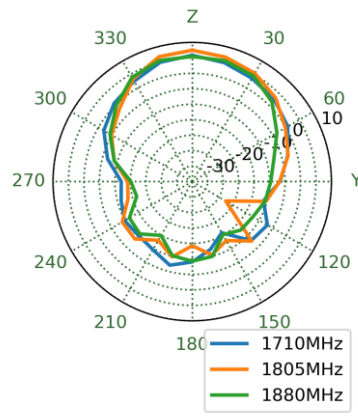
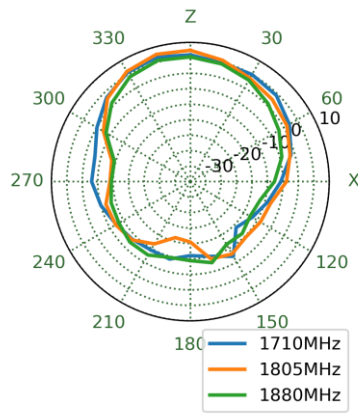
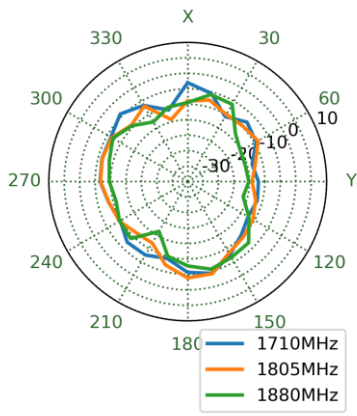

# 1920MHz

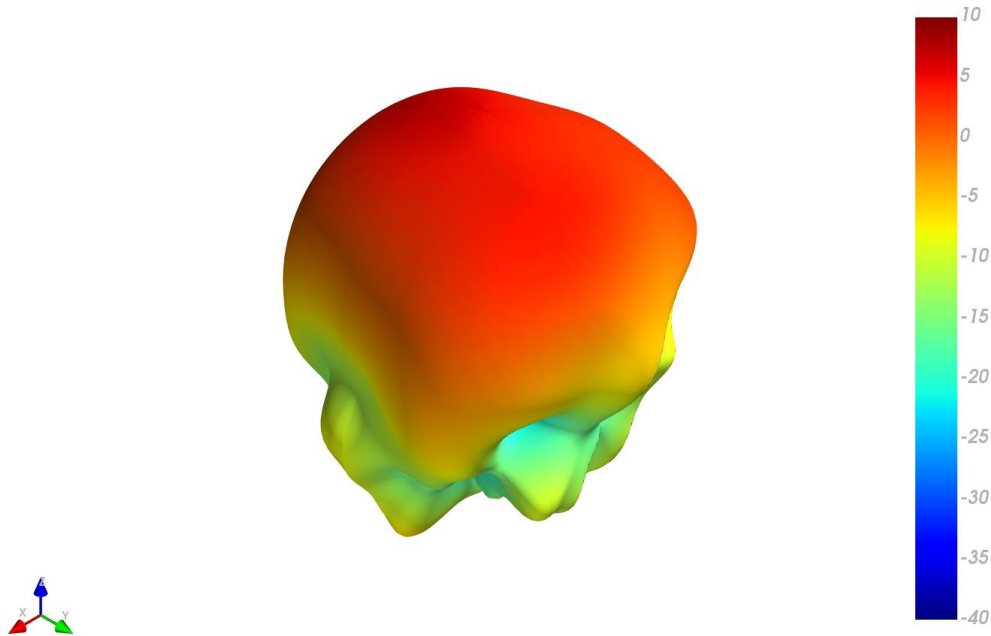

XY Plane

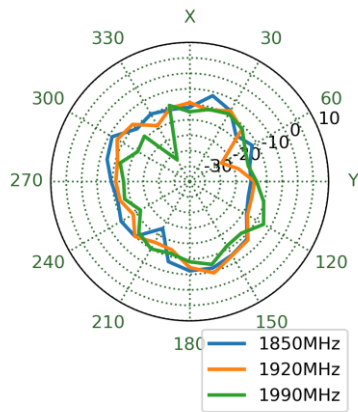

XZ Plane

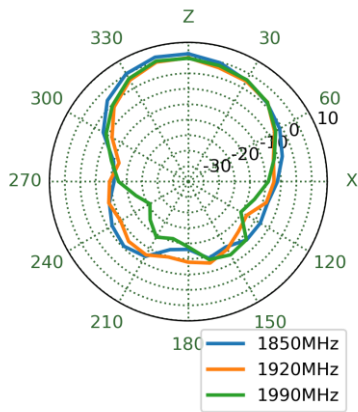

YZ Plane

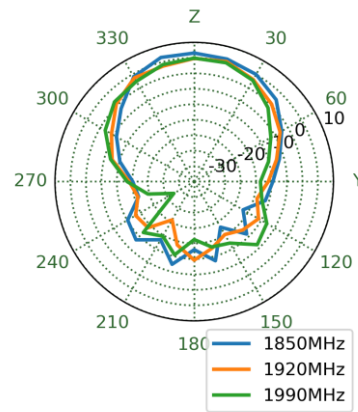

# 1990MHz

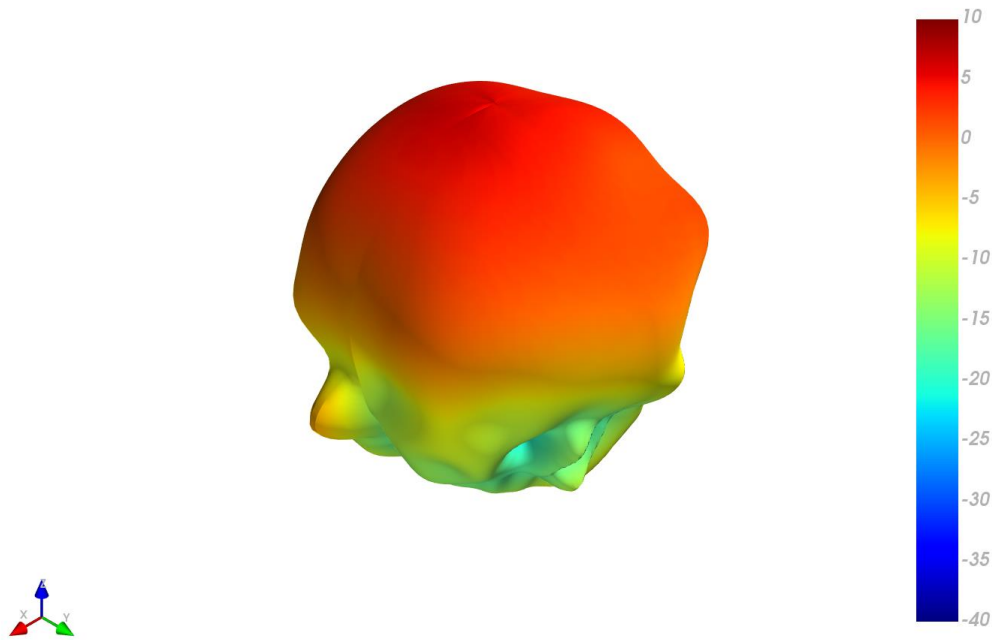

## XY Plane

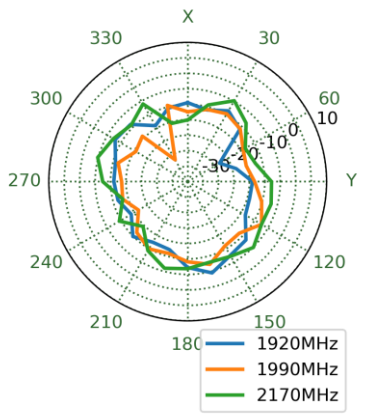

## XZ Plane

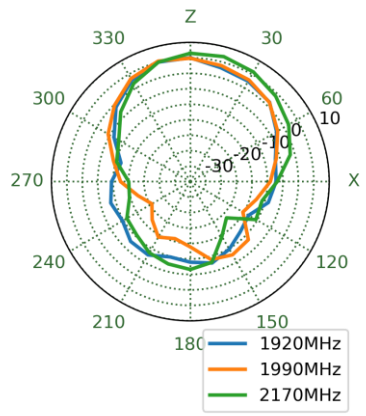

## YZ Plane

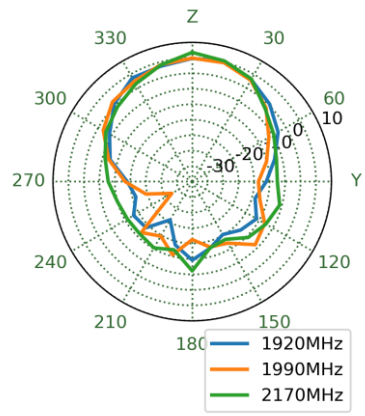

2595MHz

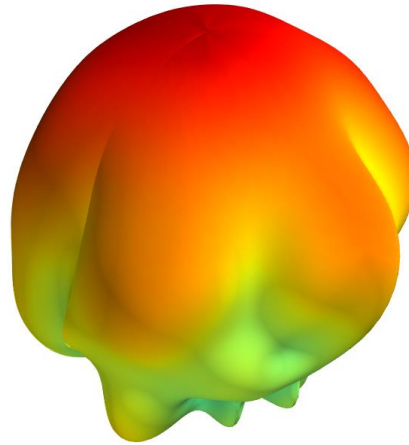

XY Plane

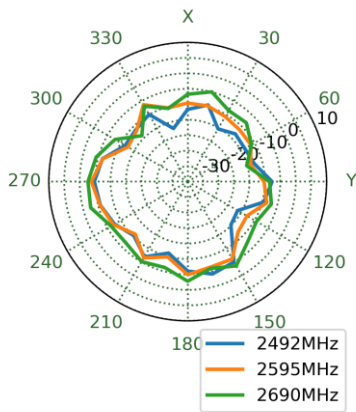

XZ Plane

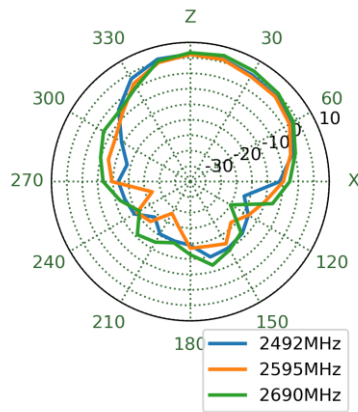

YZ Plane

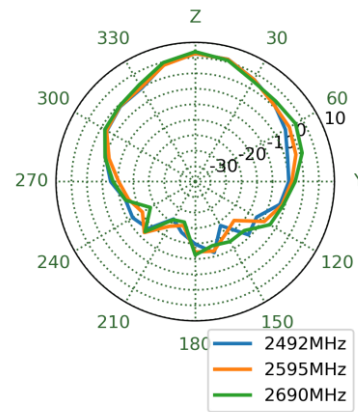

3550MHz

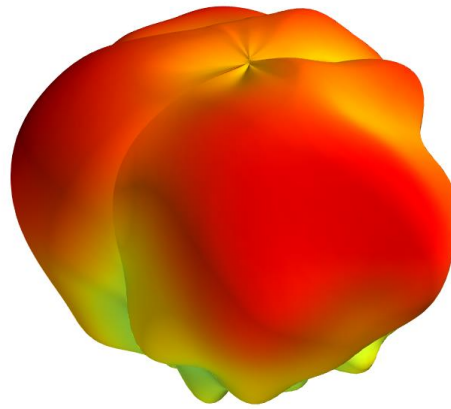

XY Plane

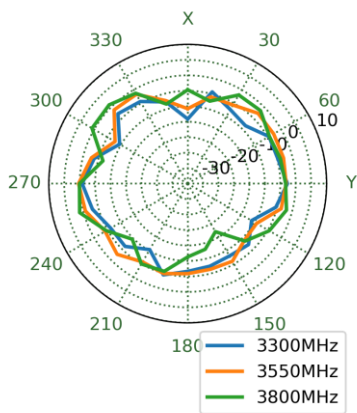

XZ Plane

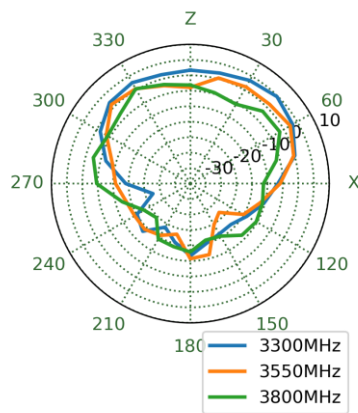

YZ Plane

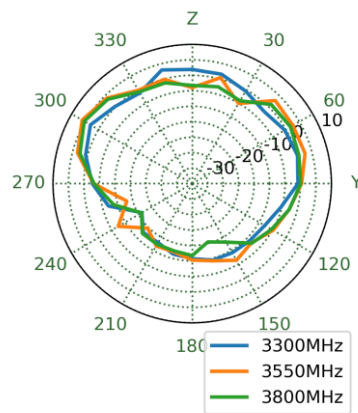



5530MHz

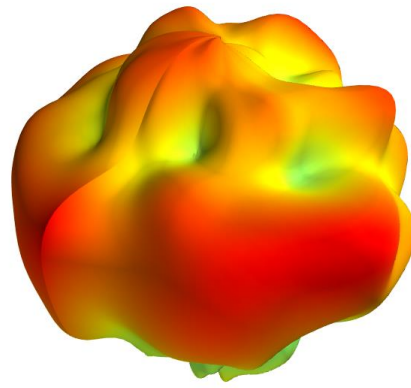

XY Plane

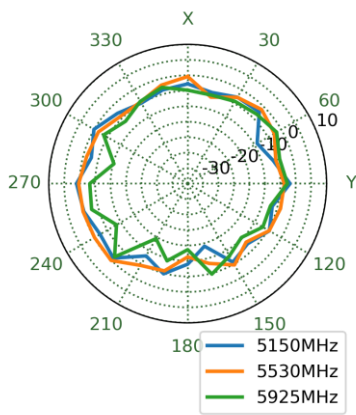

XZ Plane

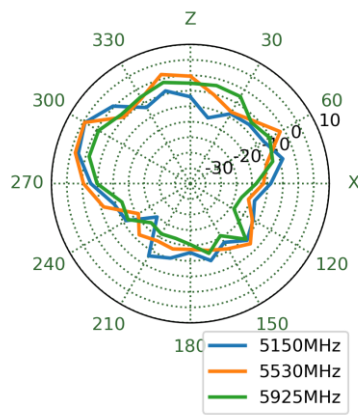

YZ Plane

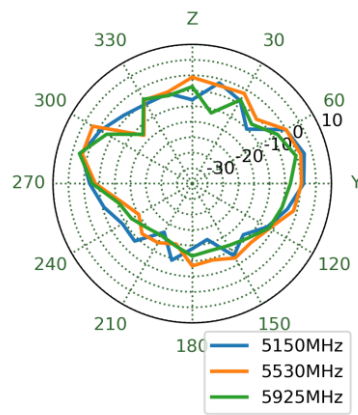

## 4.4 5G/4G MIMO 2 3D and 2D Radiation Patterns – 30\*30cm Ground Plane

652MHz

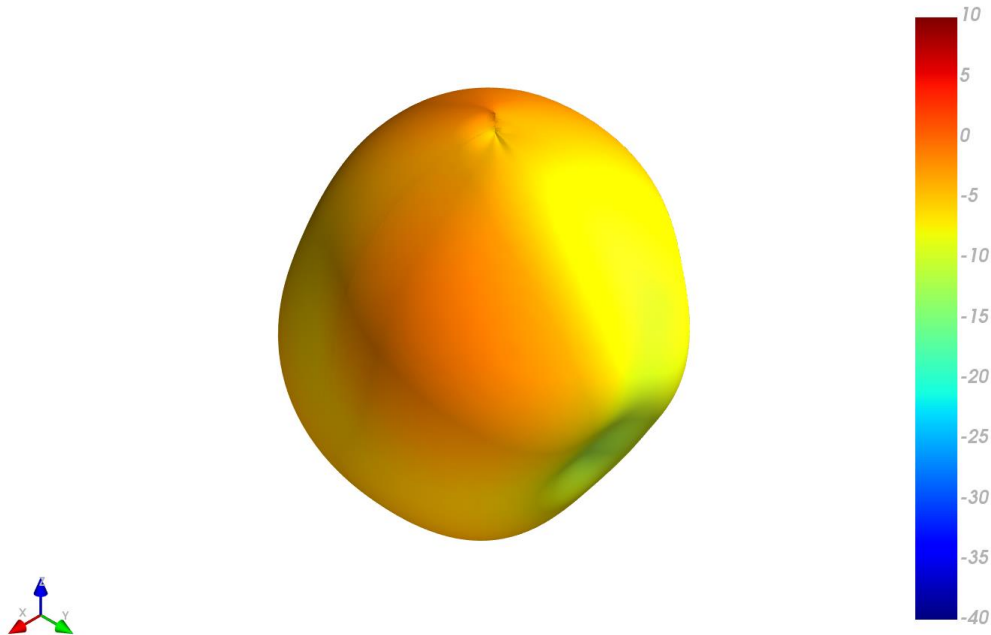

XY Plane

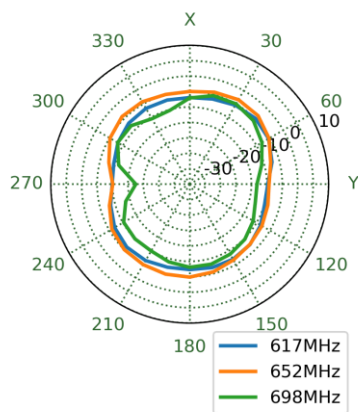

XZ Plane

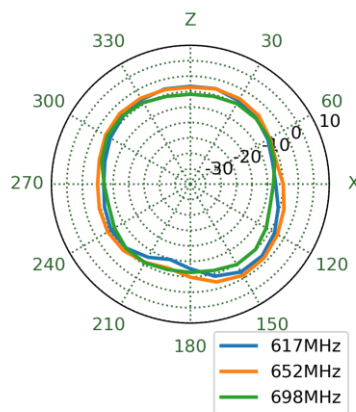

YZ Plane

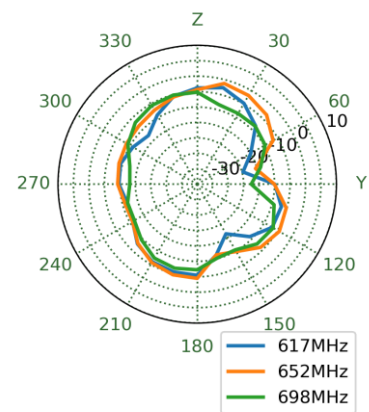

751MHz

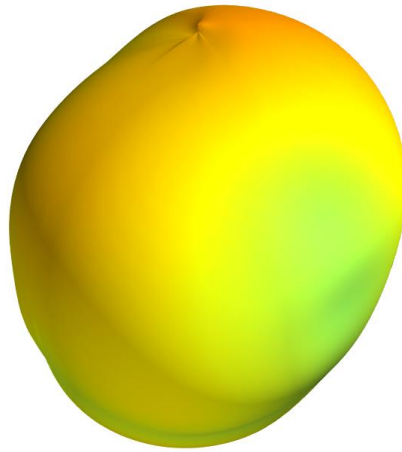

XY Plane

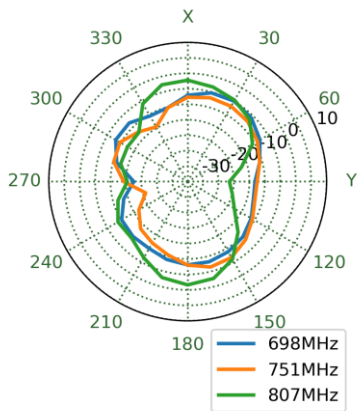

XZ Plane

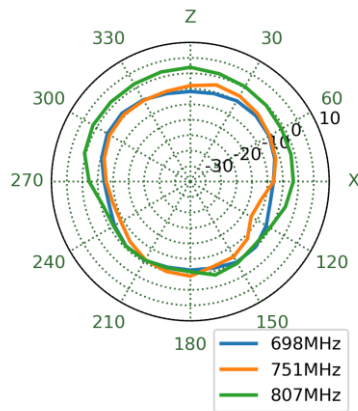

YZ Plane

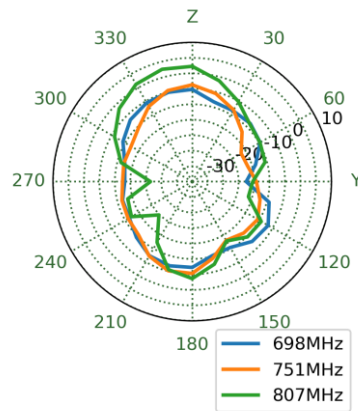

890MHz

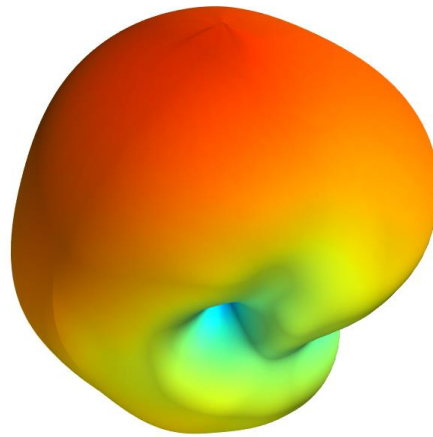

XY Plane

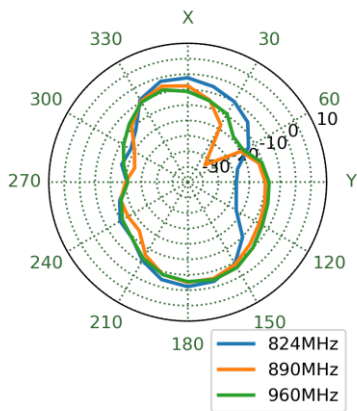

XZ Plane

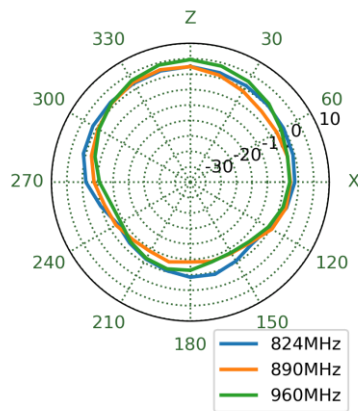

YZ Plane

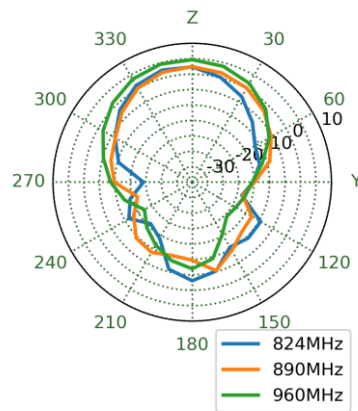

1470MHz

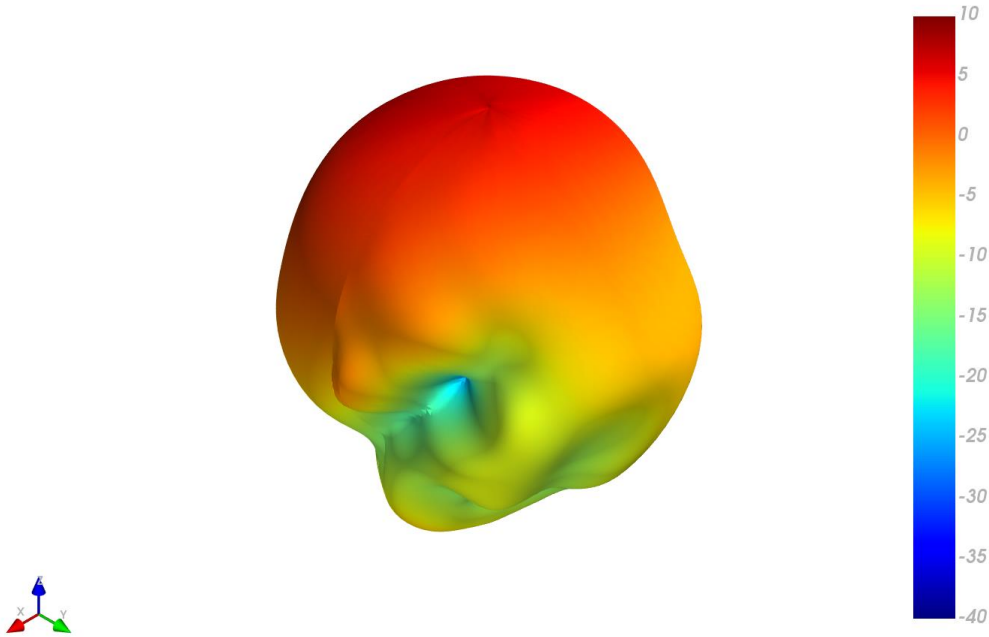

XY Plane

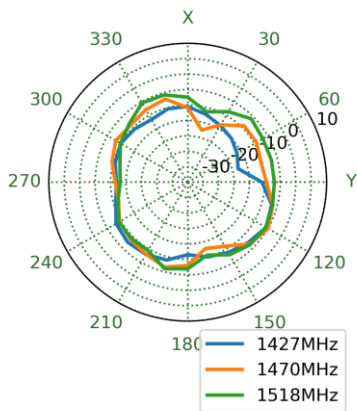

XZ Plane

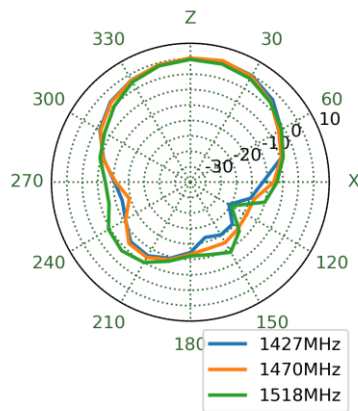

YZ Plane

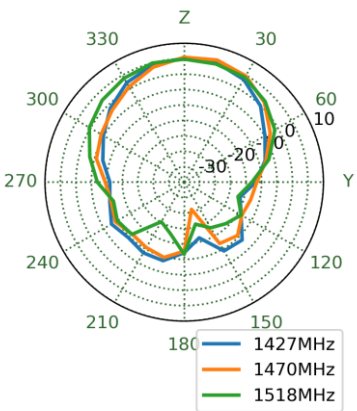

1805MHz

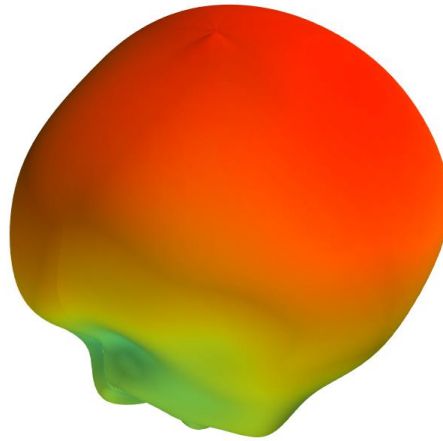

XY Plane

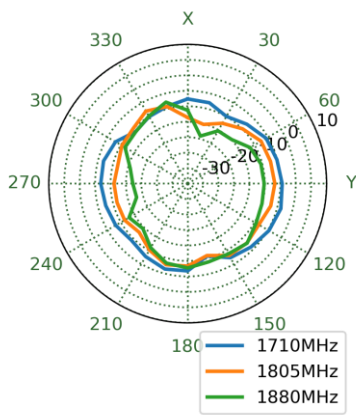

XZ Plane

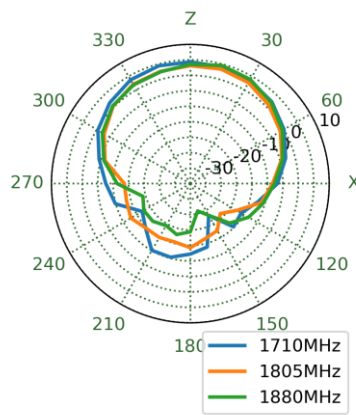

YZ Plane

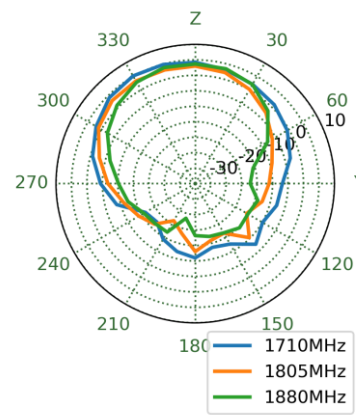

1920MHz

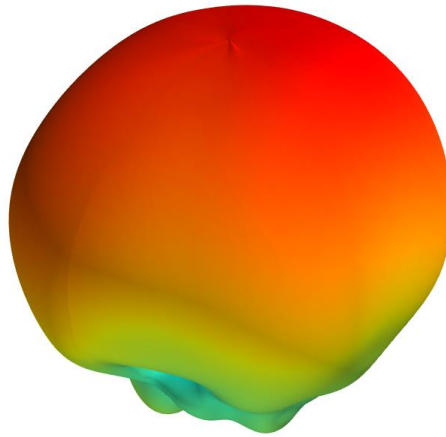

XY Plane

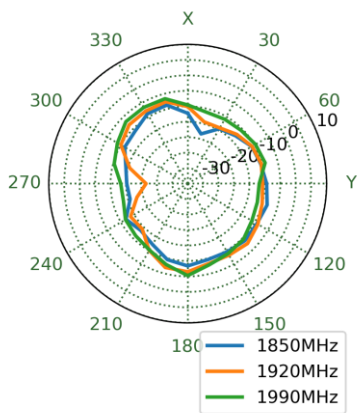

XZ Plane

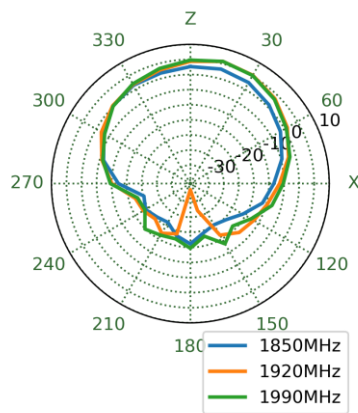

YZ Plane

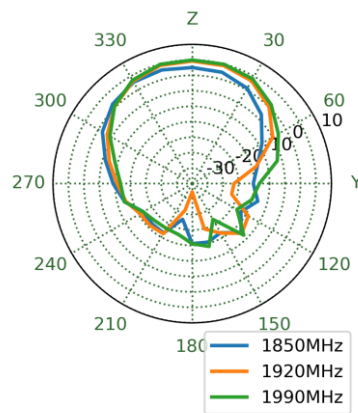



1990MHz

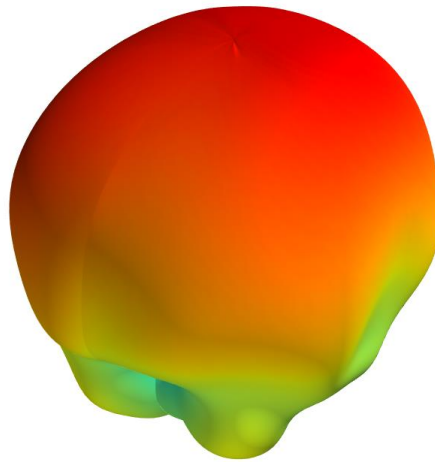

XY Plane

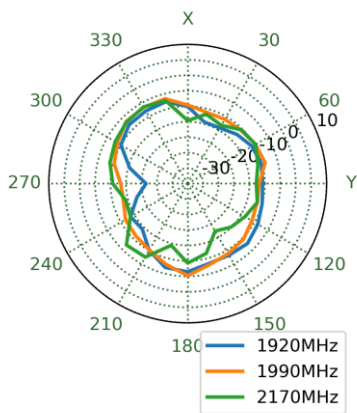

XZ Plane

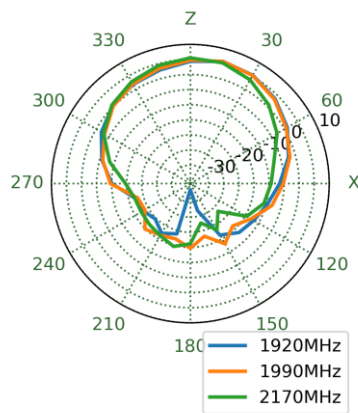

YZ Plane

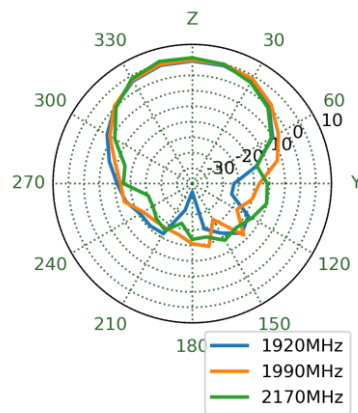

2595MHz

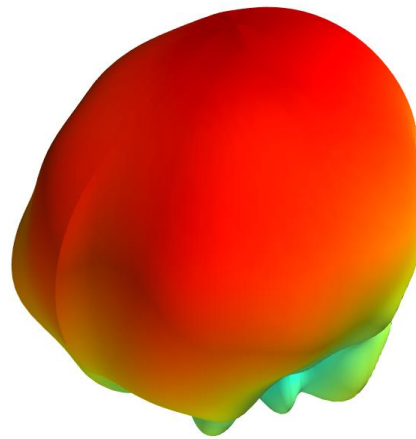

XY Plane

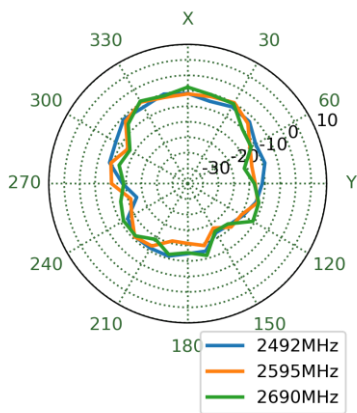

XZ Plane

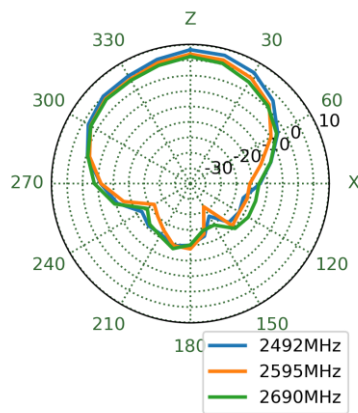

YZ Plane

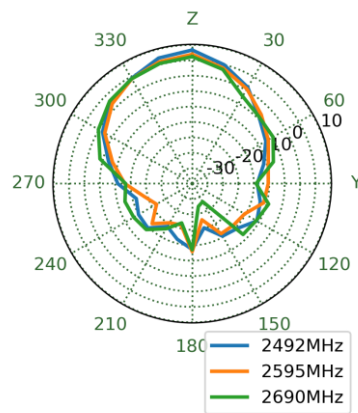

3550MHz

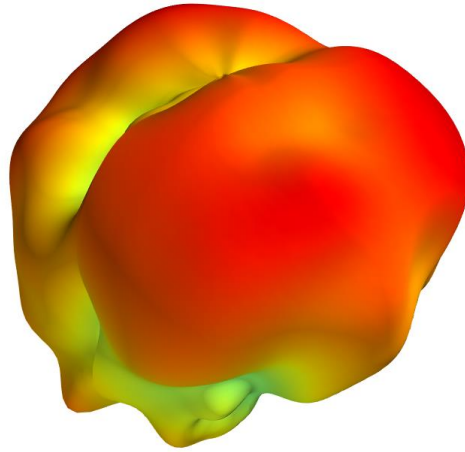

XY Plane

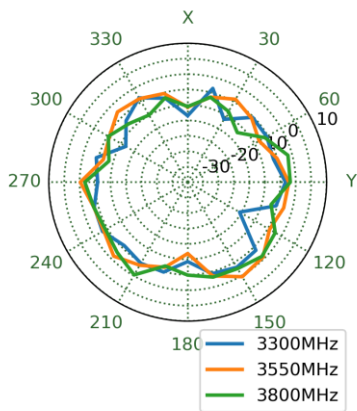

XZ Plane

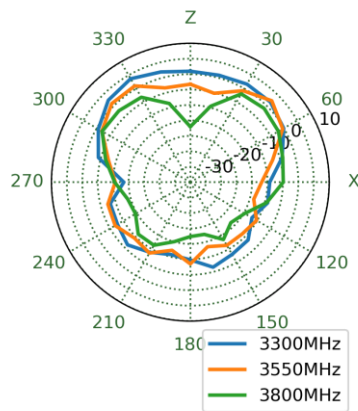

YZ Plane

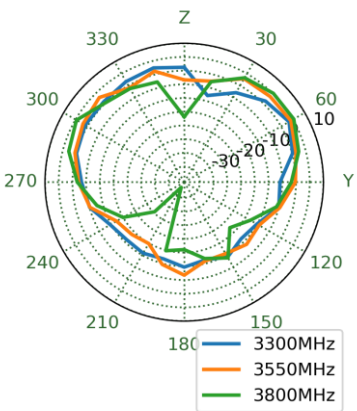

5530MHz

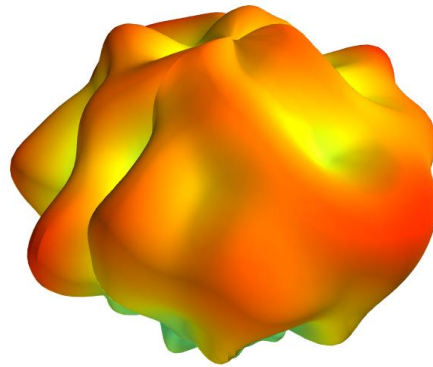

XY Plane

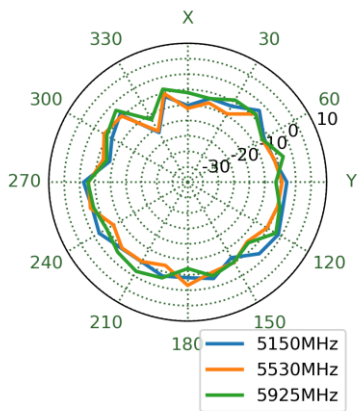

XZ Plane

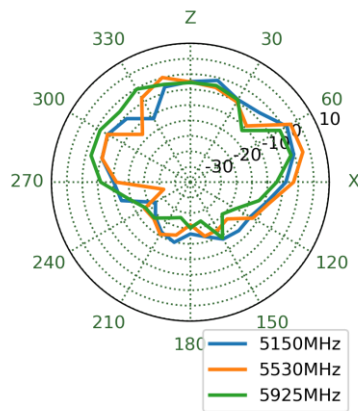

YZ Plane

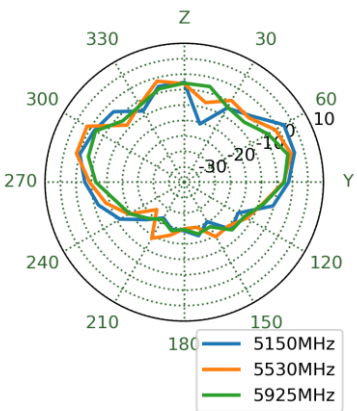

## 5. Active Antenna Characteristics

### 5.1 Block Diagram

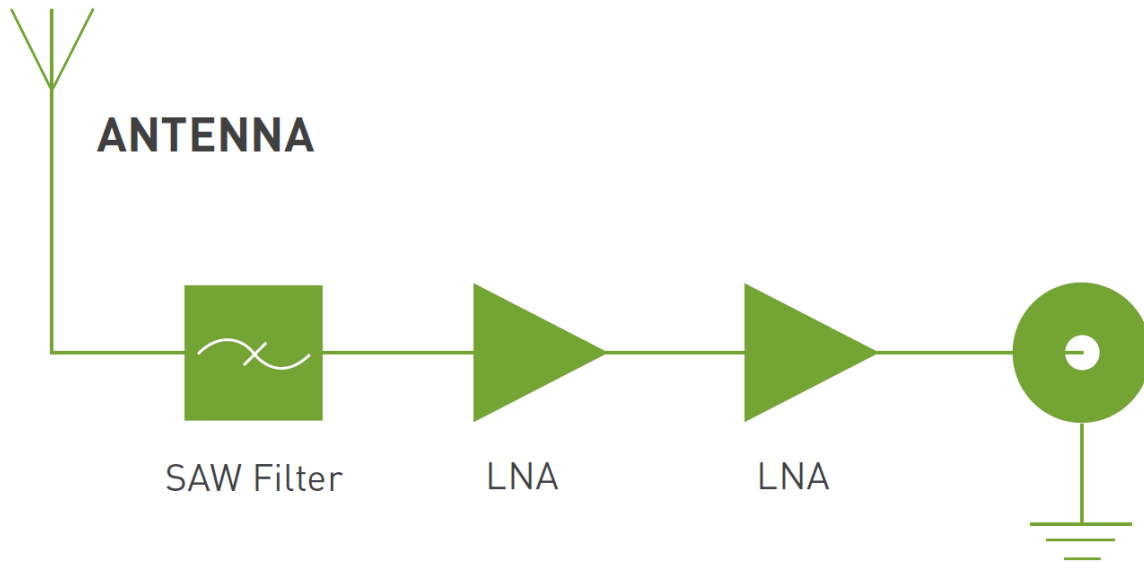

### 5.2 LNA Gain @3.0V



### 5.3 Noise Figure @3.0V

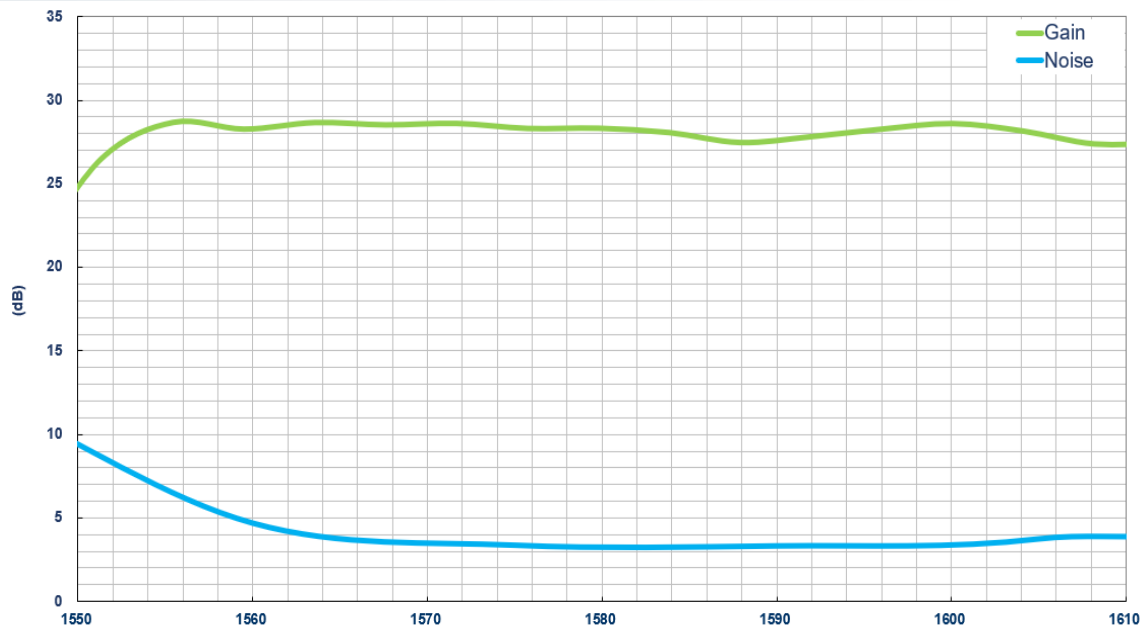

### 5.4 Axial Ratio

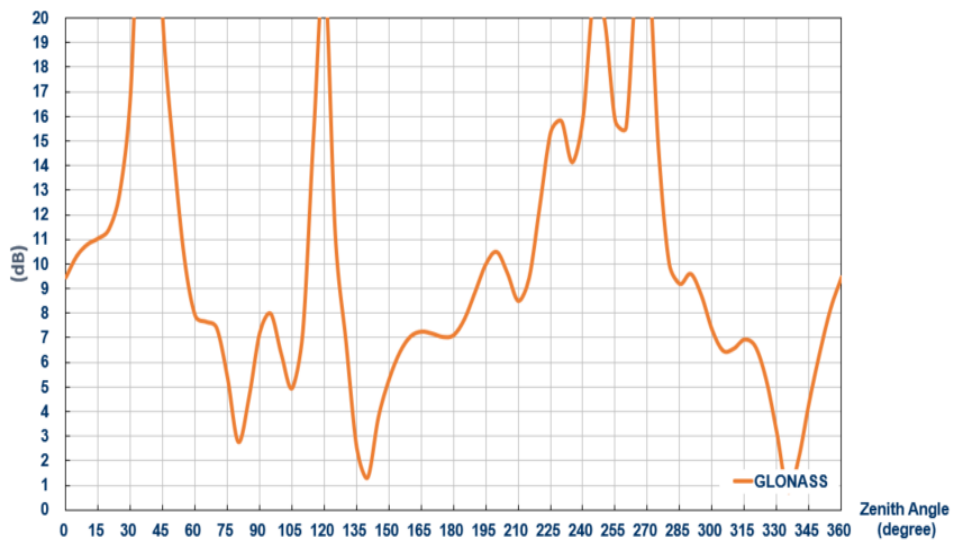
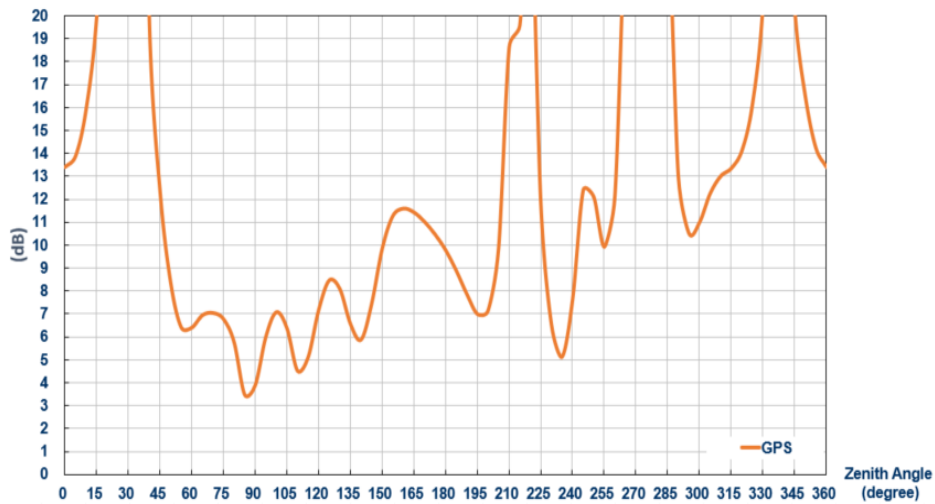

# 6. Mechanical Drawing (Units: mm)

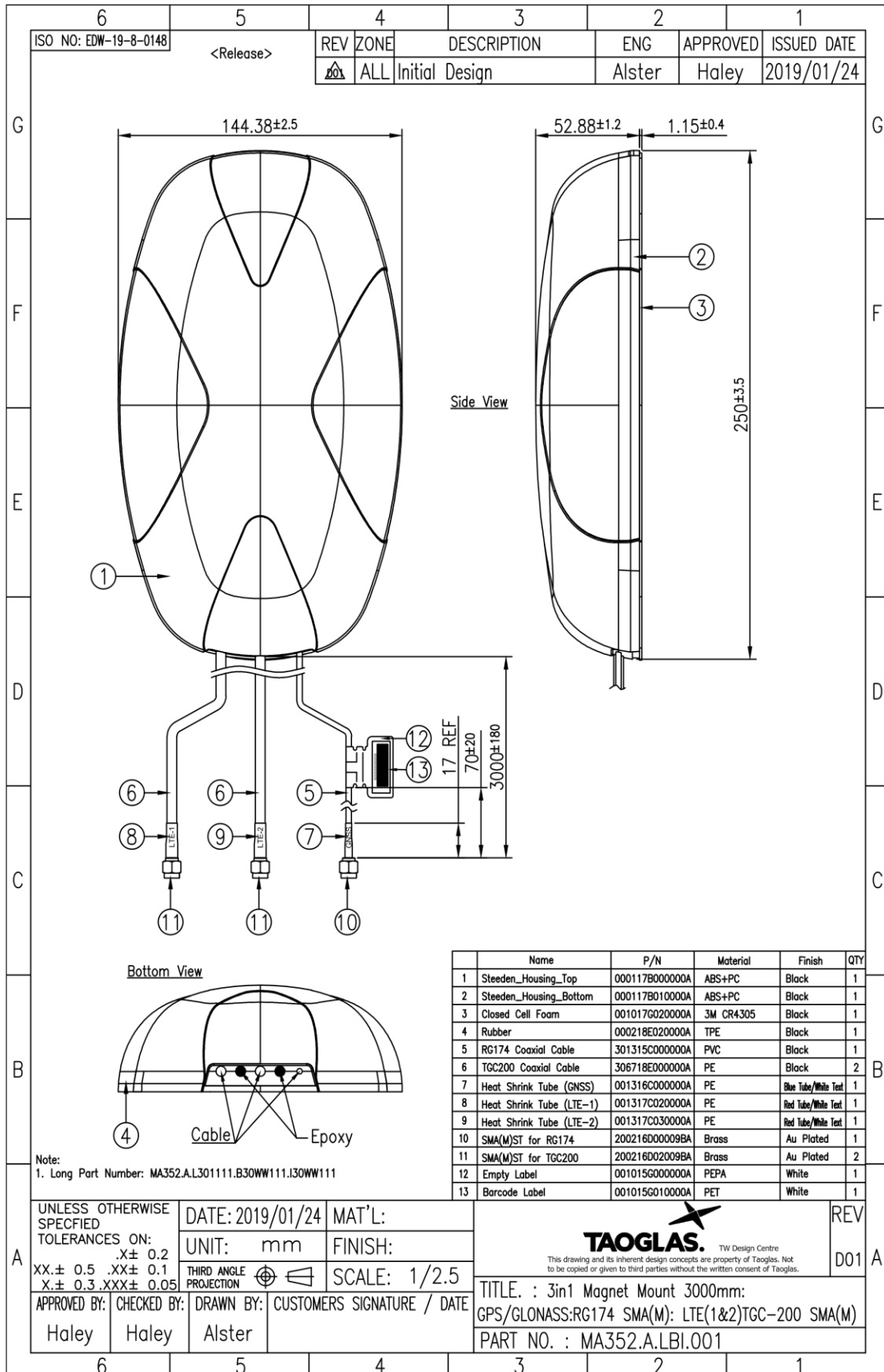

## 7. Packaging

1pc MA352.A.LBI.001 per PE Bag  
 PE Bag Dimensions - 300\*150mm  
 Weight - 0.55Kg

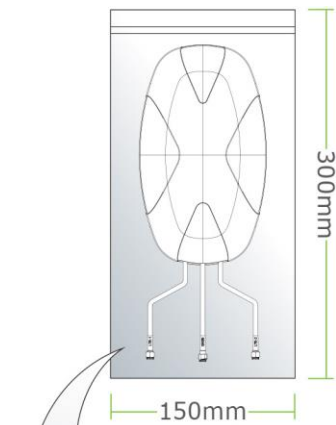

12 PE Bags per Carton  
 Box Dimensions - 549\*520\*370mm  
 Weight - 6.6Kg

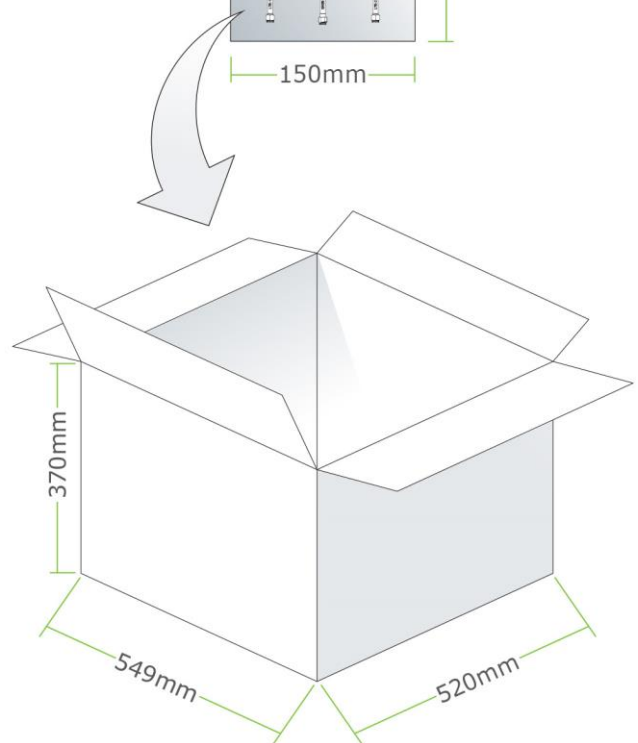



## 8. Application Note

The MA352's performance can be affected by the cable length chosen by a customer, below is the 5G/4G MIMO performance over different cable lengths.

### 8.1 Return Loss – 5G/4G MIMO 1 & 2

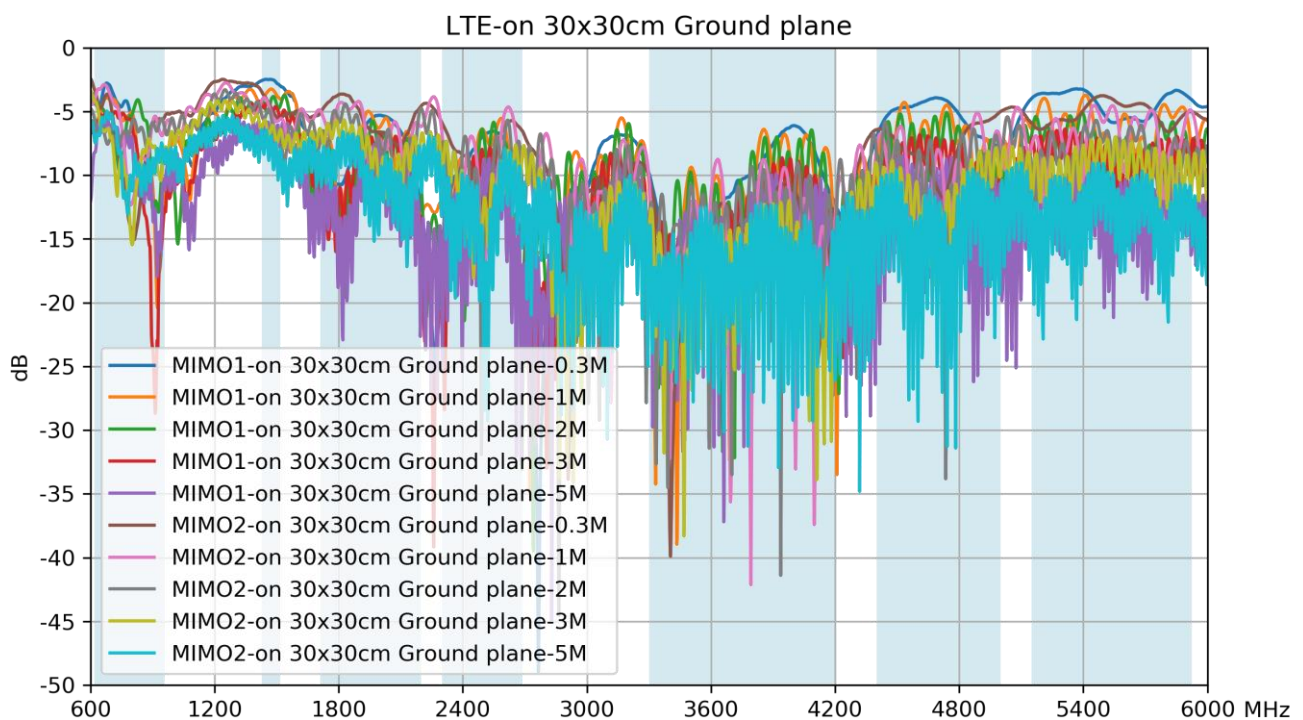
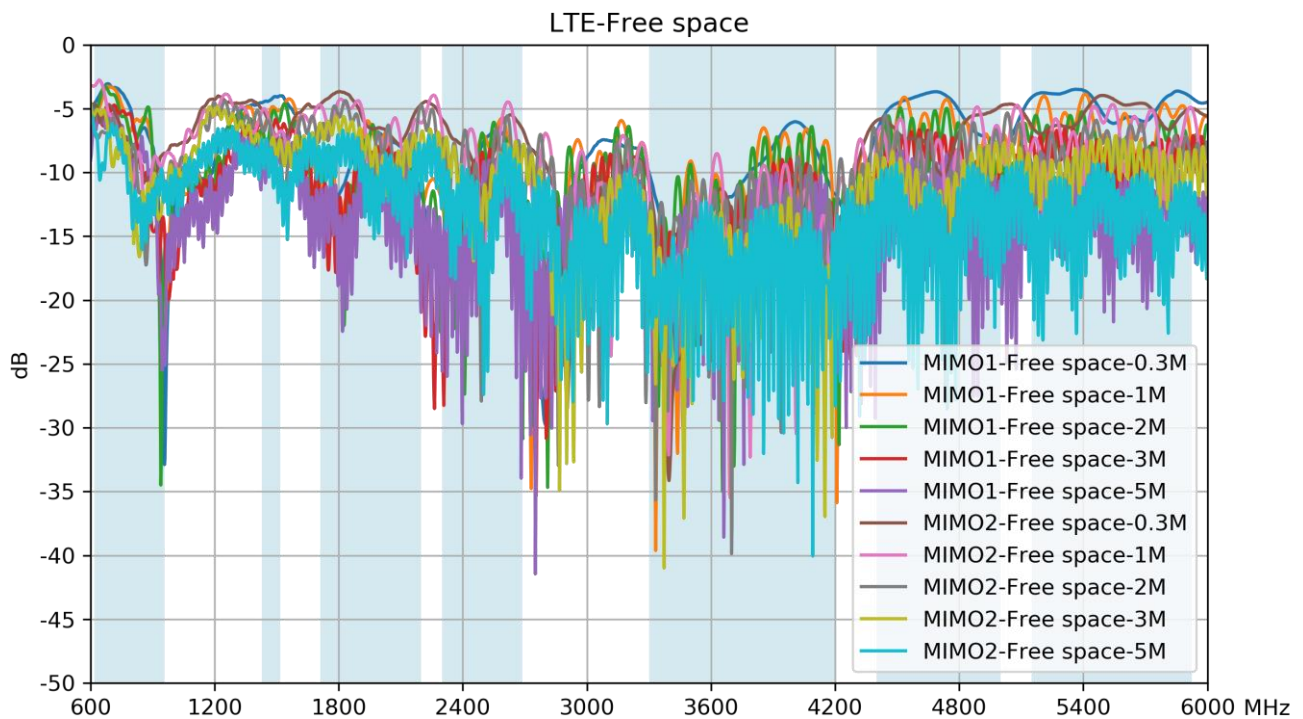

## 8.2 Efficiency – 5G/4G MIMO 1

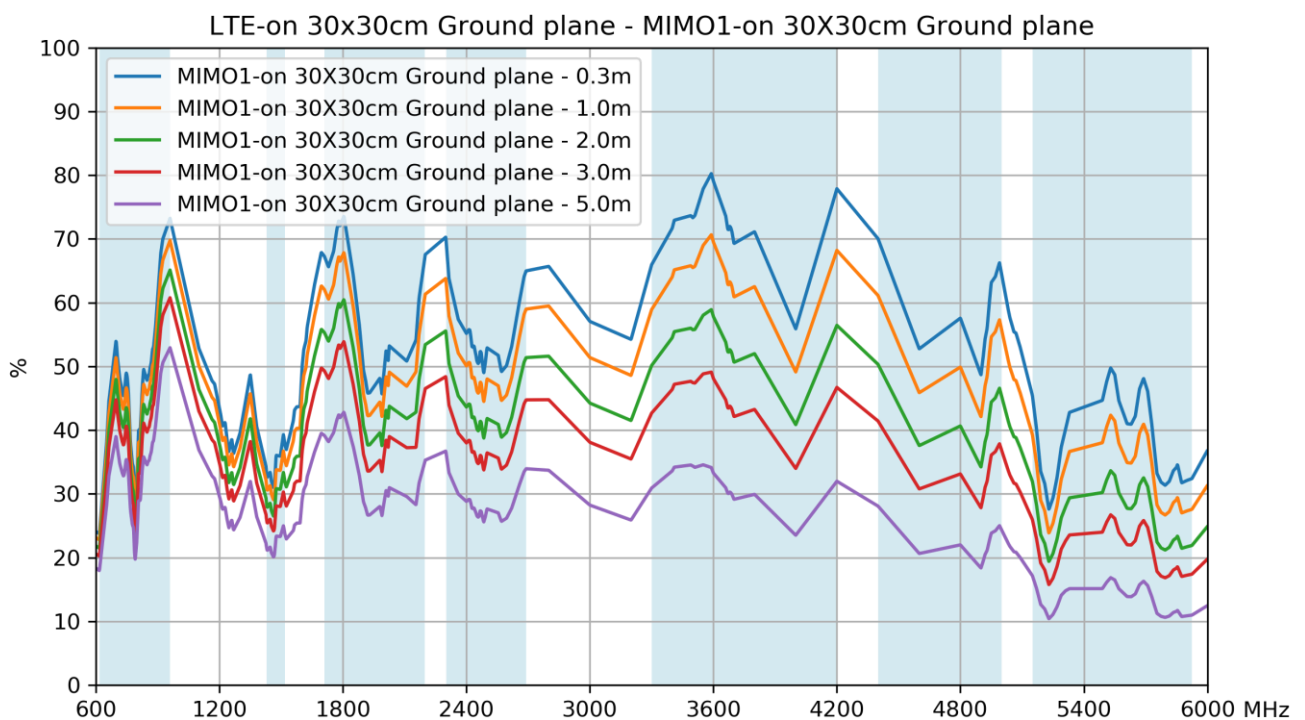
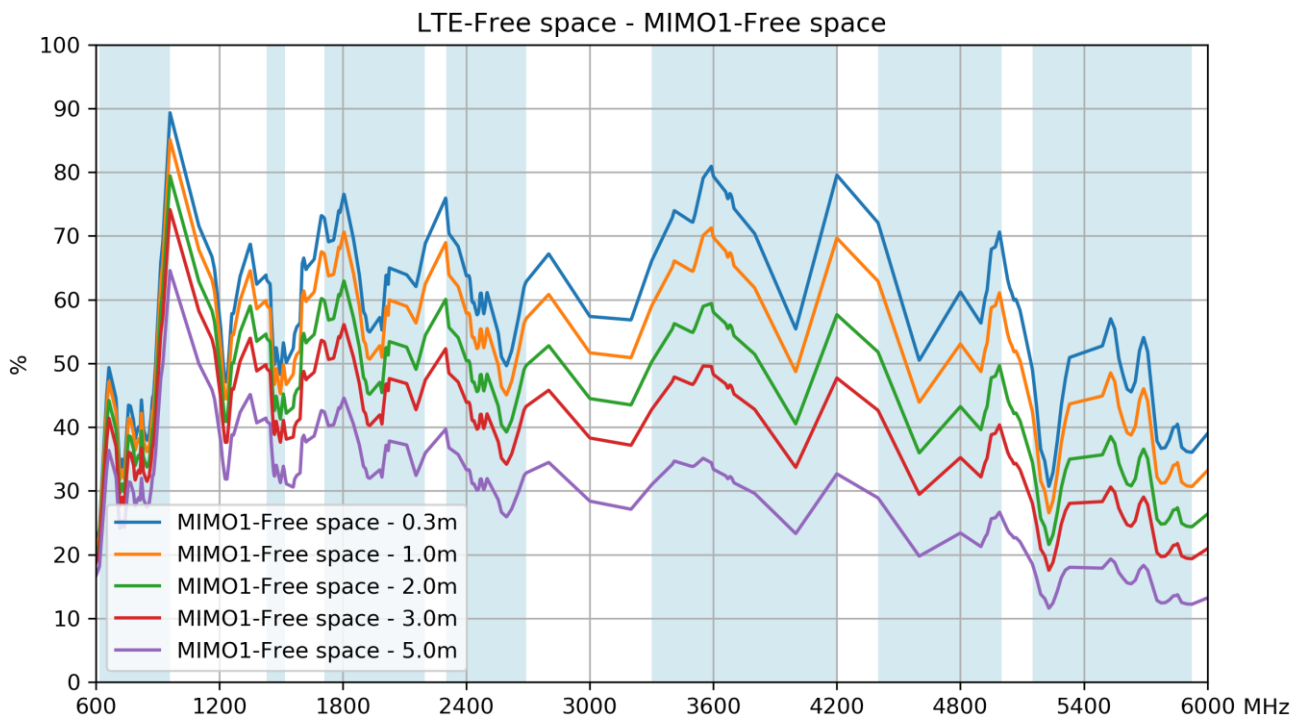

### 8.3 Efficiency – 5G/4G MIMO 2

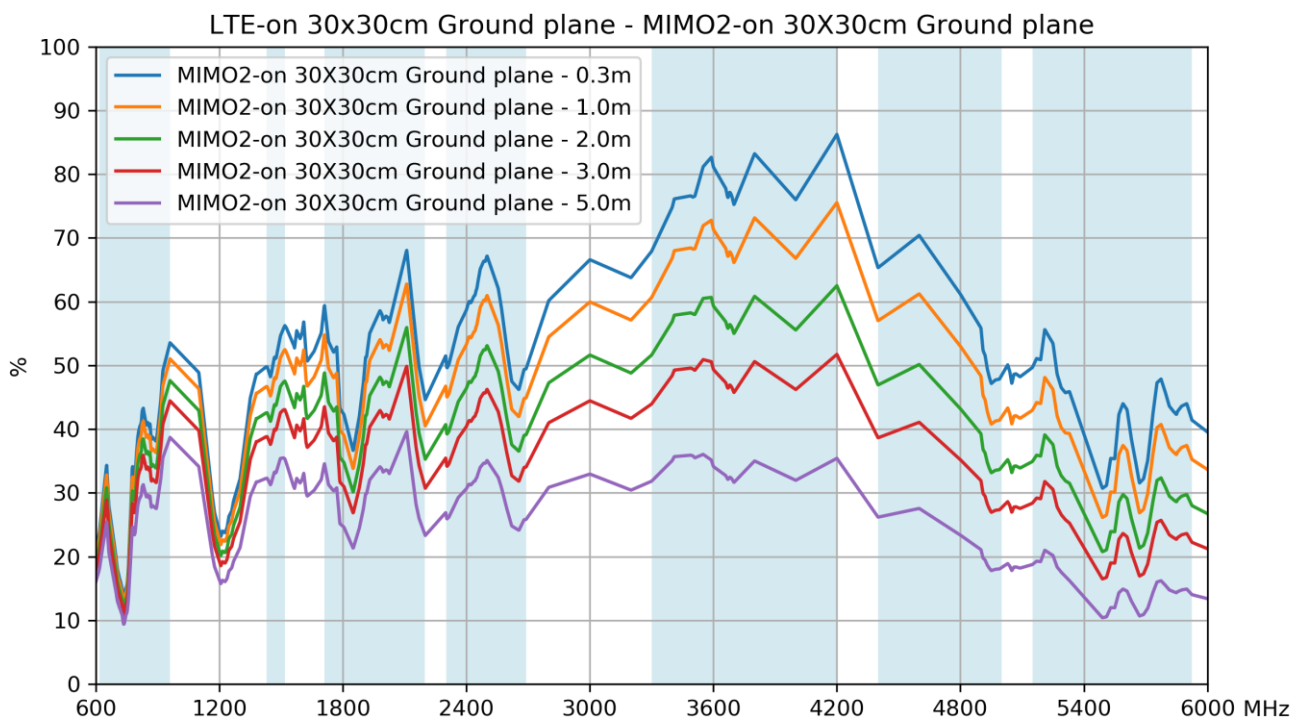
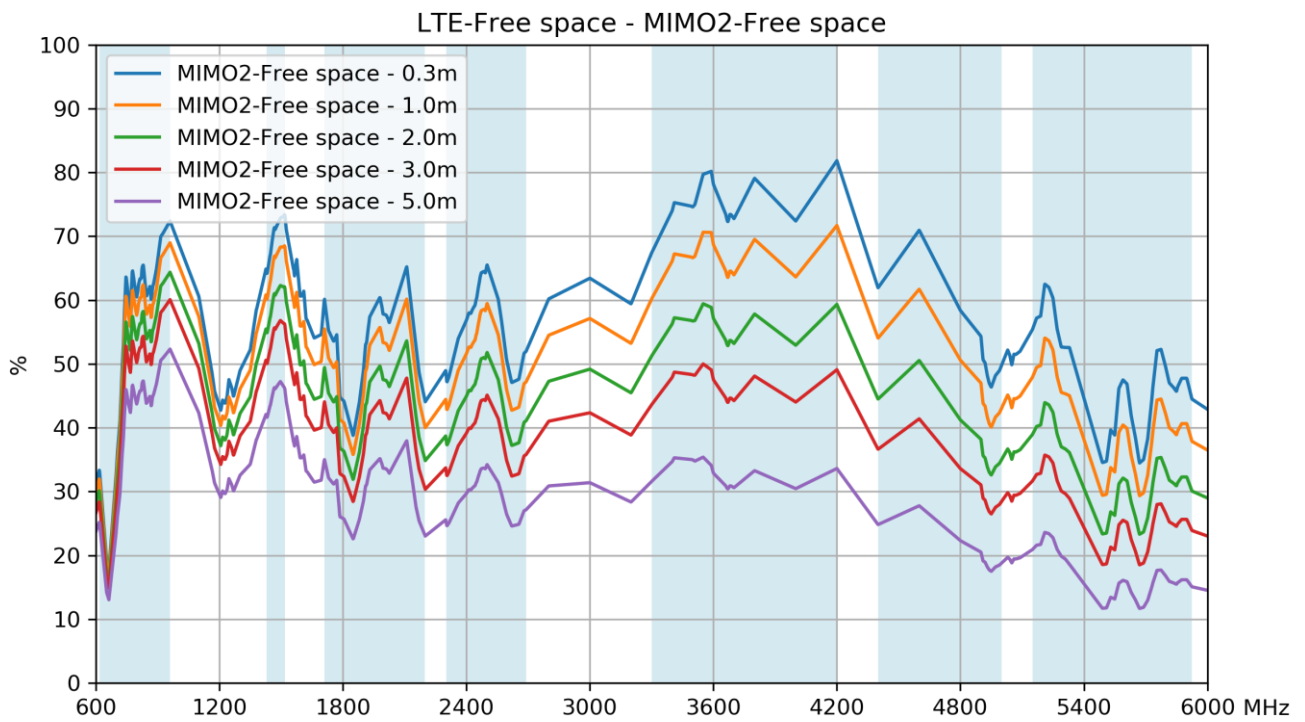

## 8.4 Average Gain – 5G/4G MIMO 1

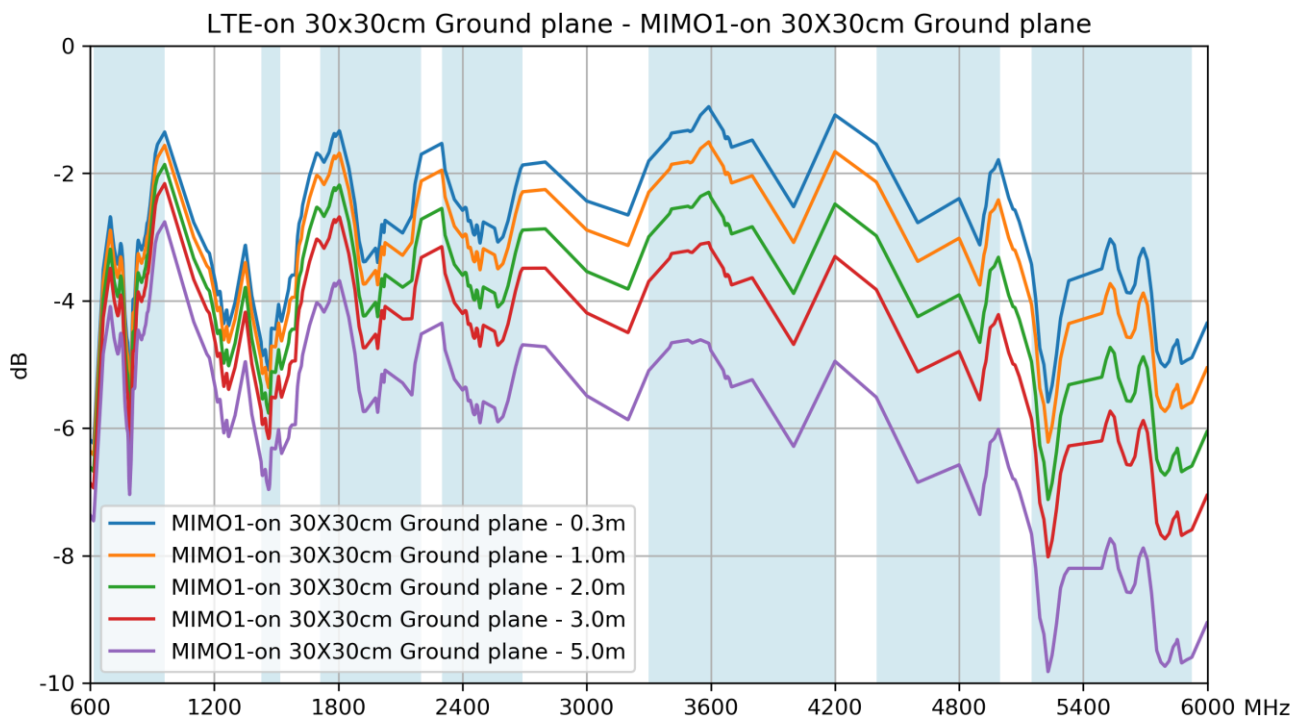
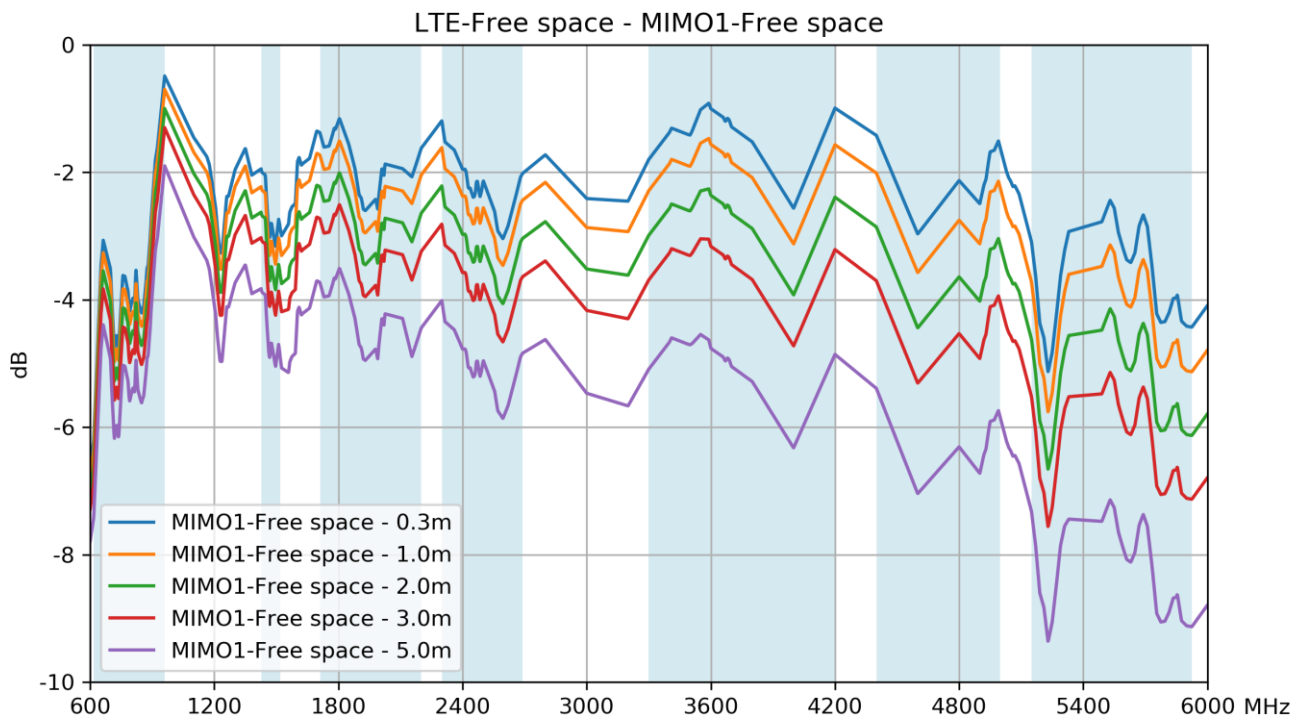



## 8.5 Average Gain – 5G/4G MIMO 2

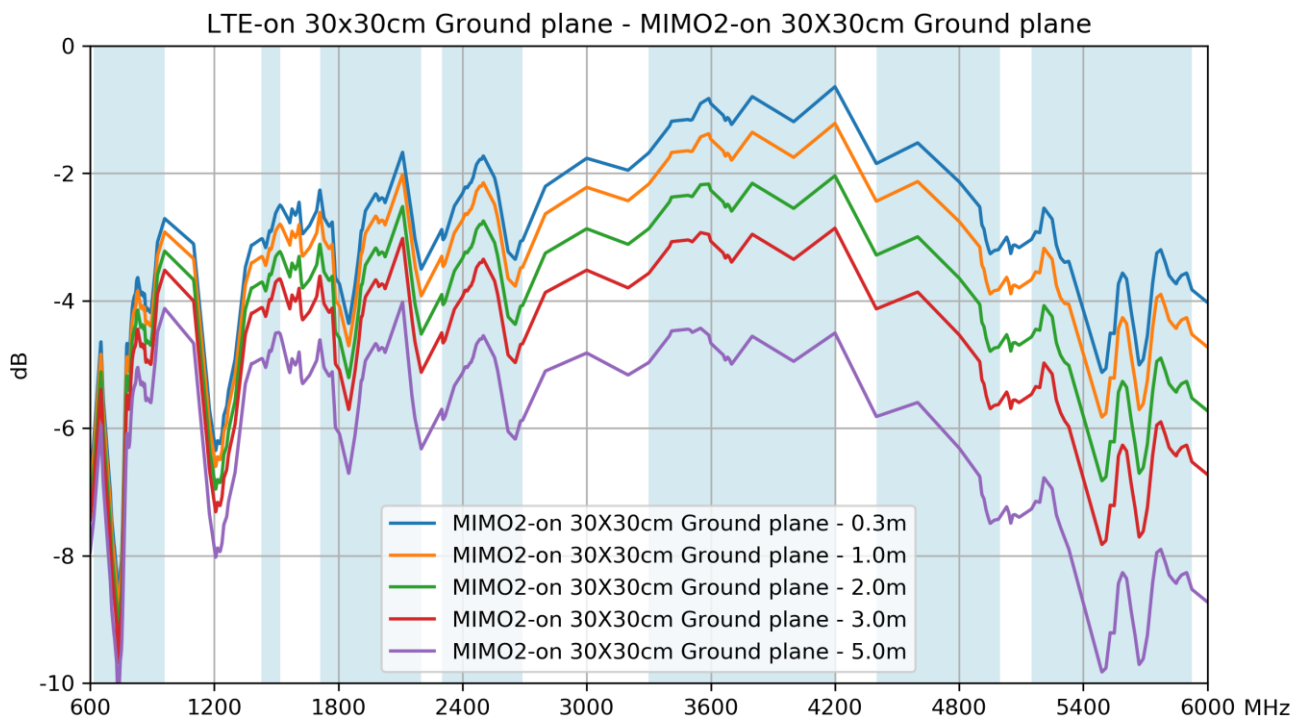
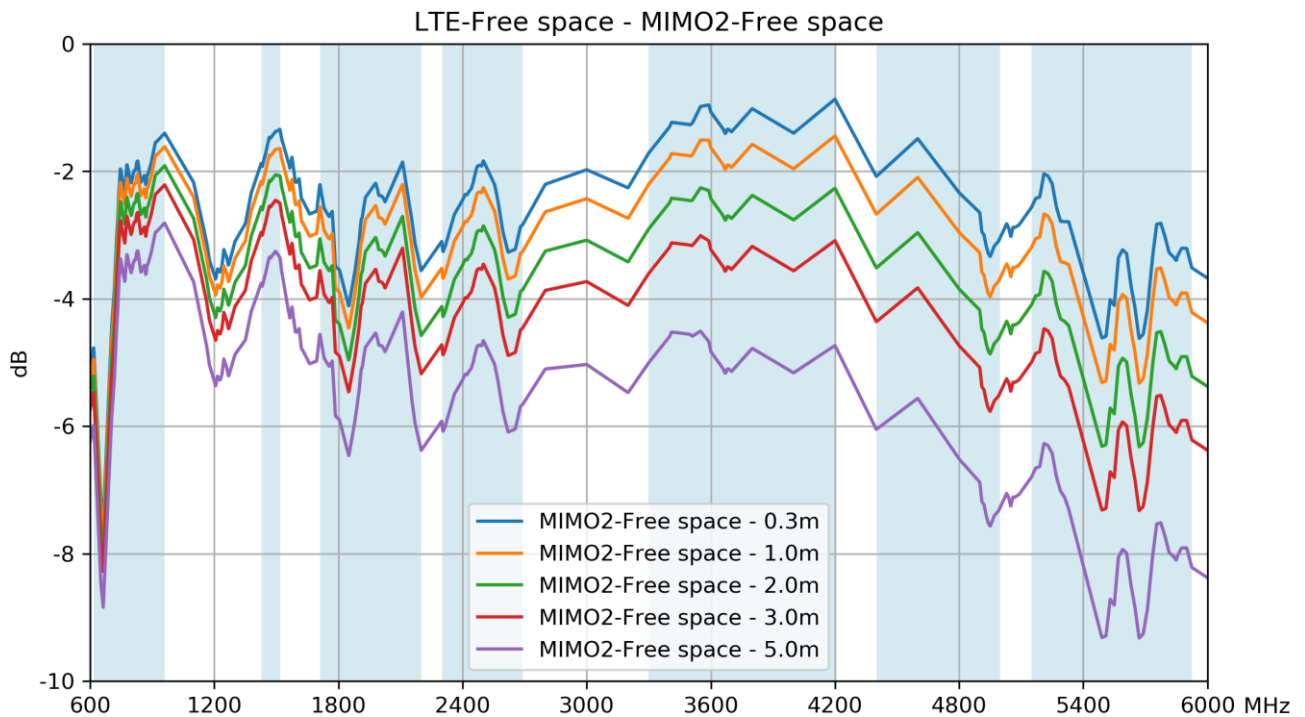

## 8.6 Peak Gain – 5G/4G MIMO 1

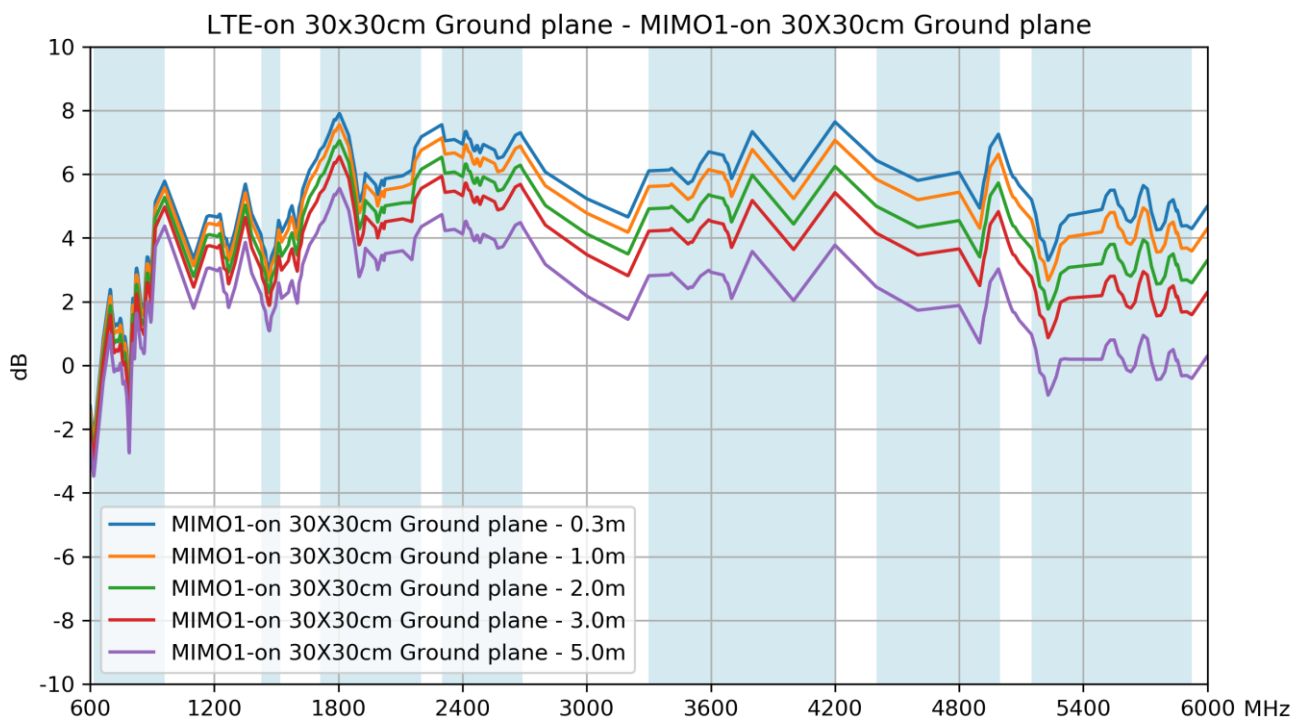
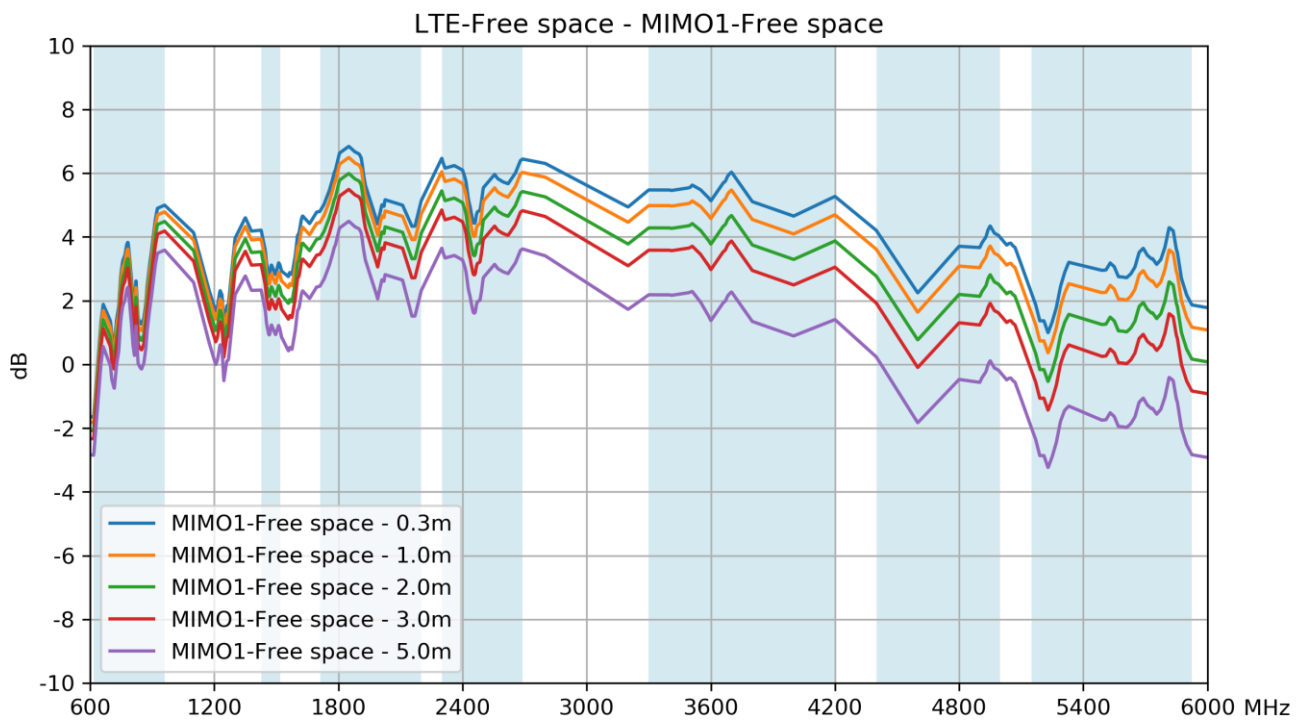

## 8.7 Peak Gain – 5G/4G MIMO 2

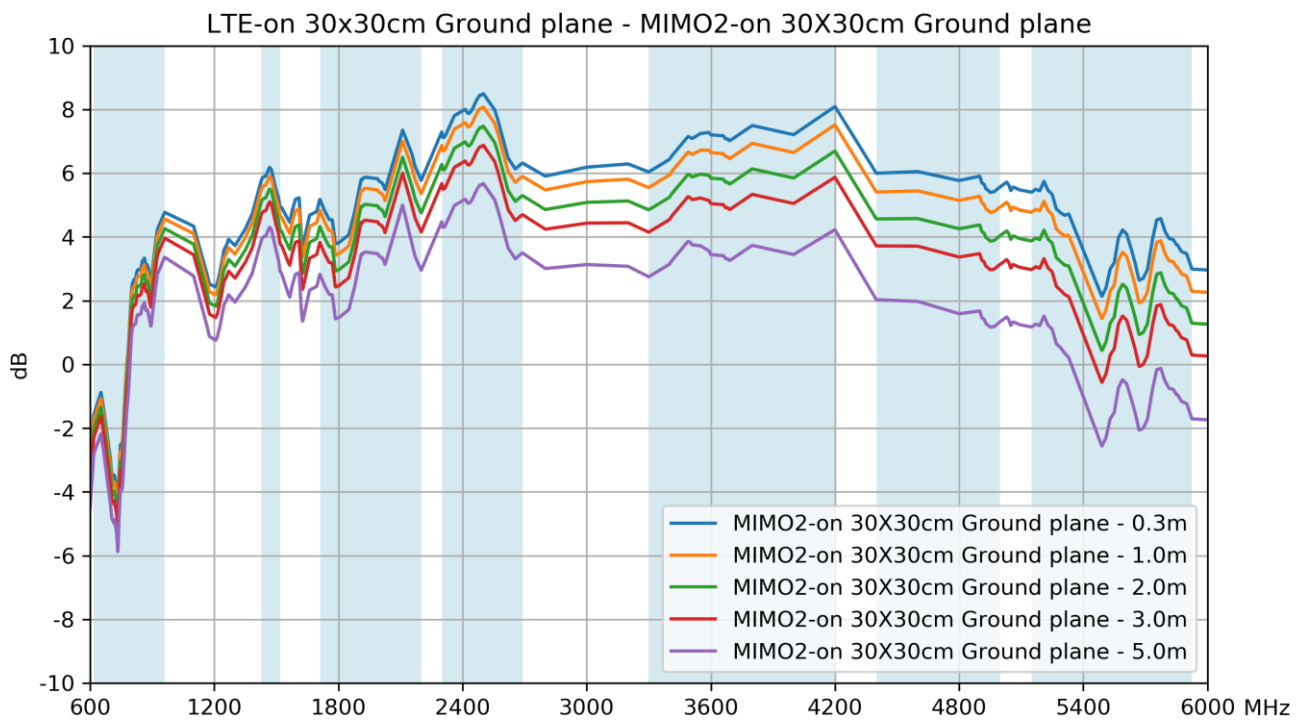
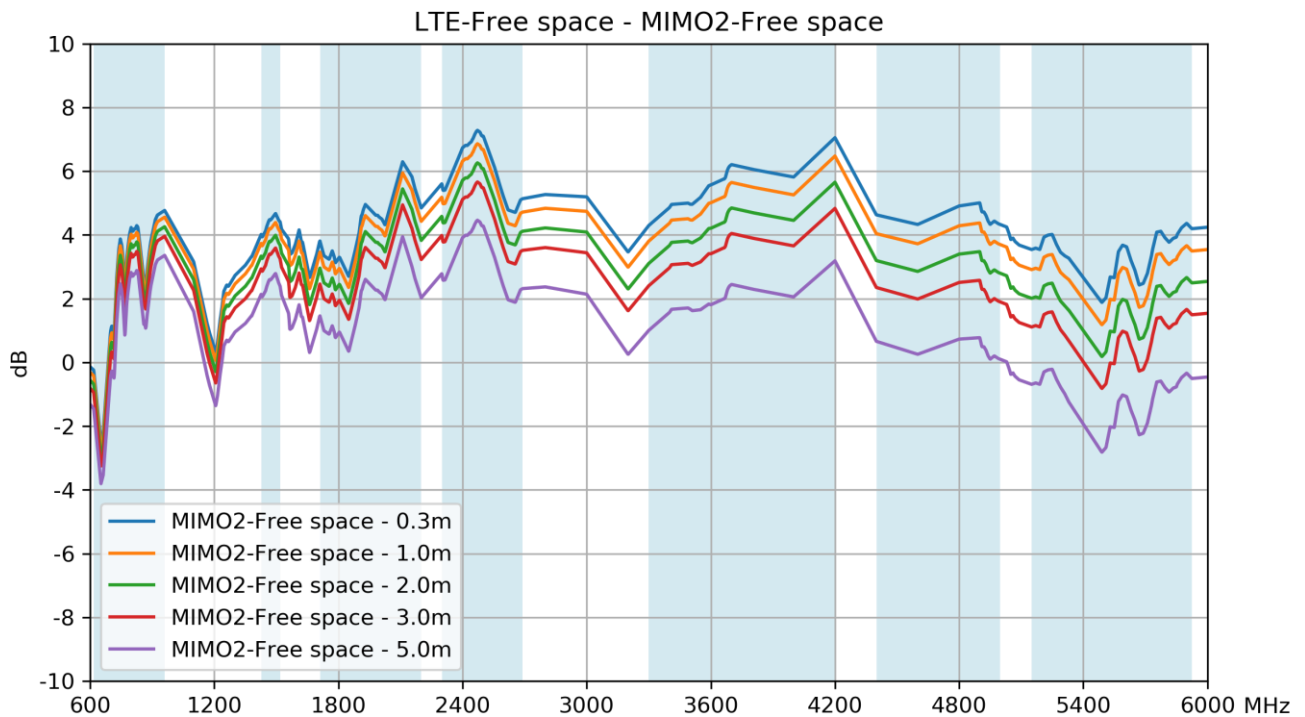

## 8.8 Comparison Table

5G/4G Antenna Free space											
Frequency (MHz)	5G NR Band 71	LTE700	GSM800 900	5G NR Band 1500	5G NR N66	LTE2600	5G NR N77	5G NR N78	5G NR N79	LTE5200	
	617-698	698-824	824-960	1427-1518	1710-2200	2300-2690	3300-4200	3300-3800	4400-5000	5150-5925	
Efficiency (%)											
MIMO1- Free space	0.3m	40.7	39.5	47.8	55.5	64.3	60.6	74.2	74.9	62.9	43.8
	1.0m	38.9	37.7	45.6	52.0	59.2	55.0	65.5	66.2	54.5	37.5
	2.0m	36.4	35.2	42.5	47.4	52.6	47.9	54.9	55.6	44.4	29.9
	3.0m	34.1	32.8	39.7	43.2	46.8	41.7	46.0	46.6	36.1	23.9
	5.0m	30.0	28.6	34.6	35.8	37.0	31.7	32.3	32.8	24.0	15.3
MIMO2- Free space	0.3m	25.7	56.7	64.2	69.7	52.9	57.4	74.8	74.6	53.2	47.5
	1.0m	24.6	54.0	61.1	65.3	48.7	52.1	66.1	65.9	46.1	40.6
	2.0m	23.1	50.4	57.0	59.4	43.3	45.4	55.4	55.3	37.6	32.5
	3.0m	21.6	47.1	53.2	54.1	38.5	39.5	46.4	46.4	30.6	26.0
	5.0m	19.0	41.0	46.4	44.9	30.4	30.0	32.6	32.6	20.3	16.7
Average Gain (dB)											
MIMO1- Free space	0.3m	-3.91	-4.03	-3.20	-2.56	-1.92	-2.17	-1.30	-1.25	-2.01	-3.58
	1.0m	-4.11	-4.24	-3.41	-2.84	-2.27	-2.59	-1.83	-1.79	-2.64	-4.26
	2.0m	-4.39	-4.54	-3.71	-3.24	-2.79	-3.19	-2.60	-2.55	-3.53	-5.24
	3.0m	-4.67	-4.84	-4.01	-3.65	-3.30	-3.79	-3.37	-3.32	-4.42	-6.21
	5.0m	-5.23	-5.44	-4.61	-4.46	-4.32	-4.99	-4.91	-4.84	-6.20	-8.16
MIMO2- Free space	0.3m	-5.90	-2.46	-1.93	-1.57	-2.76	-2.41	-1.26	-1.28	-2.74	-3.23
	1.0m	-6.09	-2.67	-2.14	-1.85	-3.12	-2.83	-1.80	-1.81	-3.36	-3.91
	2.0m	-6.37	-2.97	-2.44	-2.26	-3.63	-3.43	-2.57	-2.57	-4.25	-4.88
	3.0m	-6.65	-3.27	-2.74	-2.66	-4.14	-4.03	-3.33	-3.34	-5.14	-5.84
	5.0m	-7.21	-3.87	-3.34	-3.47	-5.16	-5.23	-4.87	-4.86	-6.92	-7.78
Peak Gain (dBi)											
MIMO1- Free space	0.3m	1.89	3.84	5.00	4.21	6.84	6.48	6.03	6.03	4.35	4.30
	1.0m	1.69	3.63	4.79	3.93	6.49	6.06	5.47	5.47	3.72	3.60
	2.0m	1.41	3.33	4.49	3.53	5.99	5.46	4.67	4.67	2.82	2.60
	3.0m	1.12	3.03	4.19	3.13	5.49	4.86	3.87	3.87	1.92	1.60
	5.0m	0.56	2.43	3.59	2.33	4.49	3.66	2.29	2.29	0.23	-0.40
MIMO2- Free space	0.3m	0.94	4.30	4.77	4.68	6.30	7.28	7.05	6.21	5.01	4.37
	1.0m	0.73	4.09	4.56	4.40	5.95	6.86	6.48	5.65	4.38	3.67
	2.0m	0.43	3.79	4.26	4.00	5.45	6.26	5.65	4.85	3.48	2.67
	3.0m	0.13	3.49	3.96	3.60	4.95	5.66	4.83	4.05	2.58	1.67
	5.0m	-0.47	2.89	3.36	2.80	3.95	4.46	3.19	2.45	0.78	-0.21



5G/4G Antenna on 30x30 cm Ground plane											
Frequency (MHz)	5G NR Band 71	LTE700	GSM800 900	5G NR Band 1500	5G NR N66	LTE2600	5G NR N77	5G NR N78	5G NR N79	LTE5200	
	617-698	698-824	824-960	1427-1518	1710-2200	2300-2690	3300-4200	3300-3800	4400-5000	5150-5925	
Efficiency (%)											
MIMO1-on 30X30cm Ground plane	0.3m	40.1	42.5	54.0	34.5	57.4	55.0	72.3	72.9	58.5	38.5
	1.0m	38.3	40.5	51.5	32.3	52.9	49.9	63.9	64.5	50.7	32.9
	2.0m	35.9	37.8	48.0	29.4	47.0	43.5	53.5	54.1	41.3	26.3
	3.0m	33.6	35.3	44.8	26.8	41.8	37.9	44.9	45.4	33.7	21.0
	5.0m	29.5	30.7	39.0	22.2	33.0	28.7	31.5	31.9	22.3	13.4
MIMO2-on 30X30cm Ground plane	0.3m	26.5	25.9	41.9	51.5	52.0	58.9	77.6	77.2	54.3	43.0
	1.0m	25.4	24.7	39.9	48.2	47.9	53.4	68.6	68.3	47.0	36.8
	2.0m	23.8	23.1	37.3	43.9	42.6	46.5	57.4	57.3	38.3	29.4
	3.0m	22.3	21.5	34.8	40.0	37.9	40.5	48.1	48.0	31.2	23.5
	5.0m	19.6	18.7	30.3	33.2	29.9	30.7	33.8	33.8	20.8	15.1
Average Gain (dB)											
MIMO1-on 30X30cm Ground plane	0.3m	-3.97	-3.72	-2.67	-4.63	-2.41	-2.60	-1.41	-1.37	-2.33	-4.14
	1.0m	-4.16	-3.93	-2.88	-4.91	-2.77	-3.02	-1.95	-1.91	-2.95	-4.82
	2.0m	-4.45	-4.23	-3.18	-5.32	-3.28	-3.62	-2.71	-2.67	-3.84	-5.80
	3.0m	-4.73	-4.53	-3.48	-5.72	-3.79	-4.22	-3.48	-3.43	-4.73	-6.77
	5.0m	-5.30	-5.13	-4.08	-6.53	-4.82	-5.42	-5.01	-4.96	-6.51	-8.72
MIMO2-on 30X30cm Ground plane	0.3m	-5.76	-5.86	-3.78	-2.88	-2.84	-2.30	-1.10	-1.12	-2.65	-3.67
	1.0m	-5.96	-6.07	-3.99	-3.17	-3.19	-2.72	-1.64	-1.66	-3.27	-4.35
	2.0m	-6.24	-6.37	-4.29	-3.57	-3.71	-3.32	-2.41	-2.42	-4.16	-5.31
	3.0m	-6.51	-6.67	-4.59	-3.98	-4.22	-3.92	-3.18	-3.19	-5.05	-6.28
	5.0m	-7.07	-7.27	-5.19	-4.79	-5.24	-5.12	-4.71	-4.71	-6.83	-8.21
Peak Gain (dBi)											
MIMO1-on 30X30cm Ground plane	0.3m	2.42	3.09	5.78	4.56	7.91	7.56	7.64	7.34	7.26	5.65
	1.0m	2.21	2.88	5.57	4.27	7.56	7.14	7.07	6.78	6.63	4.95
	2.0m	1.91	2.58	5.27	3.85	7.06	6.54	6.24	5.98	5.73	3.95
	3.0m	1.61	2.28	4.97	3.43	6.56	5.94	5.42	5.18	4.83	2.95
	5.0m	1.01	1.68	4.37	2.60	5.56	4.74	3.78	3.58	3.03	0.97
MIMO2-on 30X30cm Ground plane	0.3m	-0.87	2.88	4.77	6.19	7.35	8.50	8.09	7.50	6.05	5.75
	1.0m	-1.07	2.67	4.56	5.91	7.00	8.08	7.52	6.94	5.44	5.12
	2.0m	-1.34	2.37	4.26	5.51	6.50	7.48	6.69	6.14	4.58	4.22
	3.0m	-1.62	2.07	3.96	5.11	6.00	6.88	5.87	5.34	3.72	3.32
	5.0m	-2.17	1.47	3.36	4.31	5.00	5.68	4.23	3.86	2.03	1.52

Changelog for the datasheet

**SPE-20-8-076 – MA352.A.LBI.001**

**Revision: A (Original First Release)**

Date:	2020-07-01
Notes:	
Author:	Jack Conroy

**Previous Revisions**



**TAOGLAS**®

[www.taoglas.com](http://www.taoglas.com)

