



TAOGLAS®



Datasheet

Genesis

Part No:
MA241.BI.001

Description:

MA241 Genesis 5G/4G MIMO 2-in-1 Adhesive Mount Combination Antenna
5G/4G MIMO 600 to 960/1710 to 6000MHz

Features:

IP65 Rated Antenna
5G/4G MIMO 600 to 960/1710 to 6000MHz
Adhesive Mount Antenna
Cables: 2 meter Low Loss TGC-200
Connectors: SMA(M)ST
Dimensions: 205.8 x 68 x 12.4mm
RoHS Compliant

1. Introduction	3
2. Specifications	4
3. Antenna Characteristics	7
4. Radiation Patterns	13
5. Mechanical Drawing	58
6. Packaging	59
<hr/>	
Changelog	60

Taoglas makes no warranties based on the accuracy or completeness of the contents of this document and reserves the right to make changes to specifications and product descriptions at any time without notice. Taoglas reserves all rights to this document and the information contained herein. Reproduction, use or disclosure to third parties without express permission is strictly prohibited.



1. Introduction



The MA241 Genesis antenna is an omni-directional, fully IP65 waterproof external antenna for use in telematics, transportation and remote monitoring applications. It is designed to be mounted directly on glass or plastic in the interior of vehicles.

Typical applications

- HD Video over LTE
- First Responder and Emergency Services
- Transportation and Automotive

This unique antenna delivers powerful MIMO antenna technology for 5G/4G Bands. It enables designers to use only one antenna that covers all common frequencies for 5G and 4G globally.

5G/4G wireless applications demand high speed data uplink and downlink. High efficiency and high gain MIMO antennas are necessary to achieve the required signal to noise ratio and throughput required to solve these challenges. Taoglas also takes care to have high isolation between the two MIMO antennas to prevent self-interference. Low loss cables are used to keep efficiency high over long cable lengths. In contrast, smaller MIMO antennas with poorer quality thinner cables will have much reduced efficiency and isolation, which would lead to a large drop in system throughput or drops, and may indeed not make a system connection at all.

Cable length and connector types are customizable. Contact your regional Taoglas customer support team for further information.

2. Specifications

5G/4G MIMO Electrical									
Band	Frequency (MHz)		Efficiency (%)	Average Gain (dB)	Peak Gain (dBi)	VSWR	Impedance	Polarization	
5G NR/4G Band 5,8,12,13,14,17,18,20, 26,27,28, 29,71	600~960	MIMO1	Free Space	50	-3.0	4.0	<3.5:1	50Ω	Linear
			2mm ABS	47	-3.4	4.3			
			Glass Base	51	-3.0	4.4			
		MIMO2	Free Space	51	-3.0	3.6			
			2mm ABS	47	-3.3	3.7			
			Glass Base	51	-2.9	3.4			
4G/3G Band 1,2,3,4,9,23,25,35,39,66	1710~2200	MIMO1	Free Space	51	-3.0	3.7			
			2mm ABS	54	-2.8	4.8			
			Glass Base	58	-2.4	5.7			
		MIMO2	Free Space	55	-2.6	3.6			
			2mm ABS	55	-2.6	3.6			
			Glass Base	52	-2.9	6.6			
Wi-Fi 2400	2400~2485	MIMO1	Free Space	63	-2.0	3.2			
			2mm ABS	67	-1.7	4.3			
			Glass Base	65	-1.8	6.3			
		MIMO2	Free Space	60	-2.2	4.3			
			2mm ABS	61	-2.2	4.9			
			Glass Base	61	-2.1	6.8			
4G/3G Band 7,38,41	2490~2690	MIMO1	Free Space	68	-1.7	4.1			
			2mm ABS	70	-1.5	5.0			
			Glass Base	64	-2.0	6.6			
		MIMO2	Free Space	67	-1.7	4.5			
			2mm ABS	68	-1.7	6.1			
			Glass Base	63	-2.0	7.5			
5G NR/4G Band 22,42,43,48,77,78,79	3300~5000	MIMO1	Free Space	53	-3.1	5.0			
			2mm ABS	51	-3.2	5.0			
			Glass Base	42	-4.0	5.8			
		MIMO2	Free Space	45	-3.6	5.7			
			2mm ABS	45	-3.6	5.9			
			Glass Base	39	-4.2	6.6			
LTE5200/ Wi-Fi 5800	5150~5925	MIMO1	Free Space	42	-3.8	3.4			
			2mm ABS	42	-3.4	4.4			
			Glass Base	29	-5.4	2.4			
		MIMO2	Free Space	45	-3.5	4.5			
			2mm ABS	44	-3.6	5.4			
			Glass Base	35	-4.6	3.6			

Mechanical	
Antenna Dimensions	205.8 x 68 x 12.4mm
Housing	PC+ABS Alloy
Ingress Protection Rating	IP65
Weight	210g
Adhesive	3M 9448
Environmental	
Operation Temperature	-40°C to 80°C
Storage Temperature	-40°C to 90°C
Humidity	Non-condensing 65°C 95% RH

5G/4G Bands			
Band Number	5GNR / FR1 / LTE / LTE-Advanced / WCDMA / HSPA / HSPA+ / TD-SCDMA		
	Uplink	Downlink	Covered
1	UL: 1920 to 1980	DL: 2110 to 2170	✓
2	UL: 1850 to 1910	DL: 1930 to 1990	✓
3	UL: 1710 to 1785	DL: 1805 to 1880	✓
4	UL: 1710 to 1755	DL: 2110 to 2155	✓
5	UL: 824 to 849	DL: 869 to 894	✓
7	UL: 2500 to 2570	DL: 2620 to 2690	✓
8	UL: 880 to 915	DL: 925 to 960	✓
9	UL: 1749.9 to 1784.9	DL: 1844.9 to 1879.9	✓
11	UL: 1427.9 to 1447.9	DL: 1475.9 to 1495.9	✗
12	UL: 699 to 716	DL: 729 to 746	✓
13	UL: 777 to 787	DL: 746 to 756	✓
14	UL: 788 to 798	DL: 758 to 768	✓
17	UL: 704 to 716	DL: 734 to 746	✓
18	UL: 815 to 830	DL: 860 to 875	✓
19	UL: 830 to 845	DL: 875 to 890	✓
20	UL: 832 to 862	DL: 791 to 821	✓
21	UL: 1447.9 to 1462.9	DL: 1495.9 to 1510.9	✗
22	UL: 3410 to 3490	DL: 3510 to 3590	✓
23	UL: 2000 to 2020	DL: 2180 to 2200	✓
24	UL: 1625.5 to 1660.5	DL: 1525 to 1559	✗
25	UL: 1850 to 1915	DL: 1930 to 1995	✓
26	UL: 814 to 849	DL: 859 to 894	✓
27	UL: 807 to 824	DL: 852 to 869	✓
28	UL: 703 to 748	DL: 758 to 803	✓
29	UL: -	DL: 717 to 728	✓
30	UL: 2305 to 2315	DL: 2350 to 2360	✓
31	UL: 452.5 to 457.5	DL: 462.5 to 467.5	✗
32	UL: -	DL: 1452 - 1496	✗
35		1850 to 1910	✓
38		2570 to 2620	✓
39		1880 to 1920	✓
40		2300 to 2400	✓
41		2496 to 2690	✓
42		3400 to 3600	✓
43		3600 to 3800	✓
48		3550 to 3700	✓
66	UL: 1710-1780	DL: 2110-2200	✓
71		617 to 698	✓
74/75/76		1427 to 1518	✗
78		3300 to 3800	✓
79		4400 to 5000	✗
85	698-716	728-746	✓

3. Antenna Characteristics

3.1 Return Loss & Isolation - Freespace

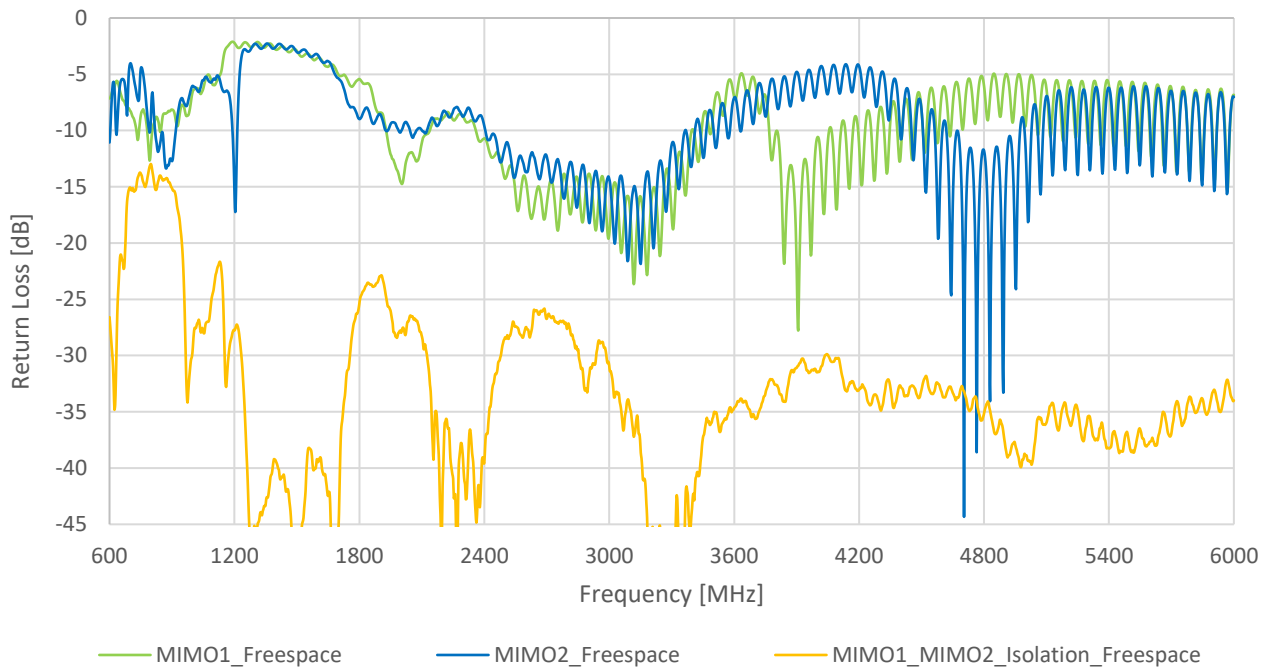

3.2 Return Loss & Isolation – 2mm ABS

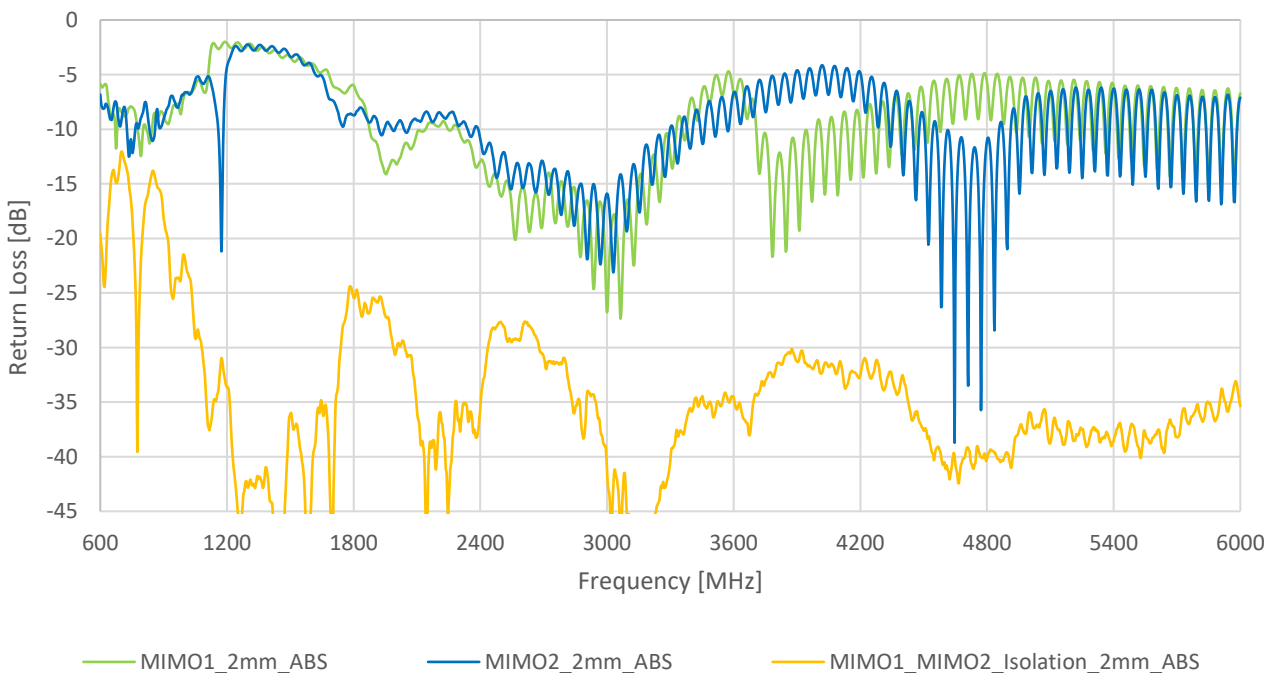

3.3 Return Loss & Isolation – Glass Base

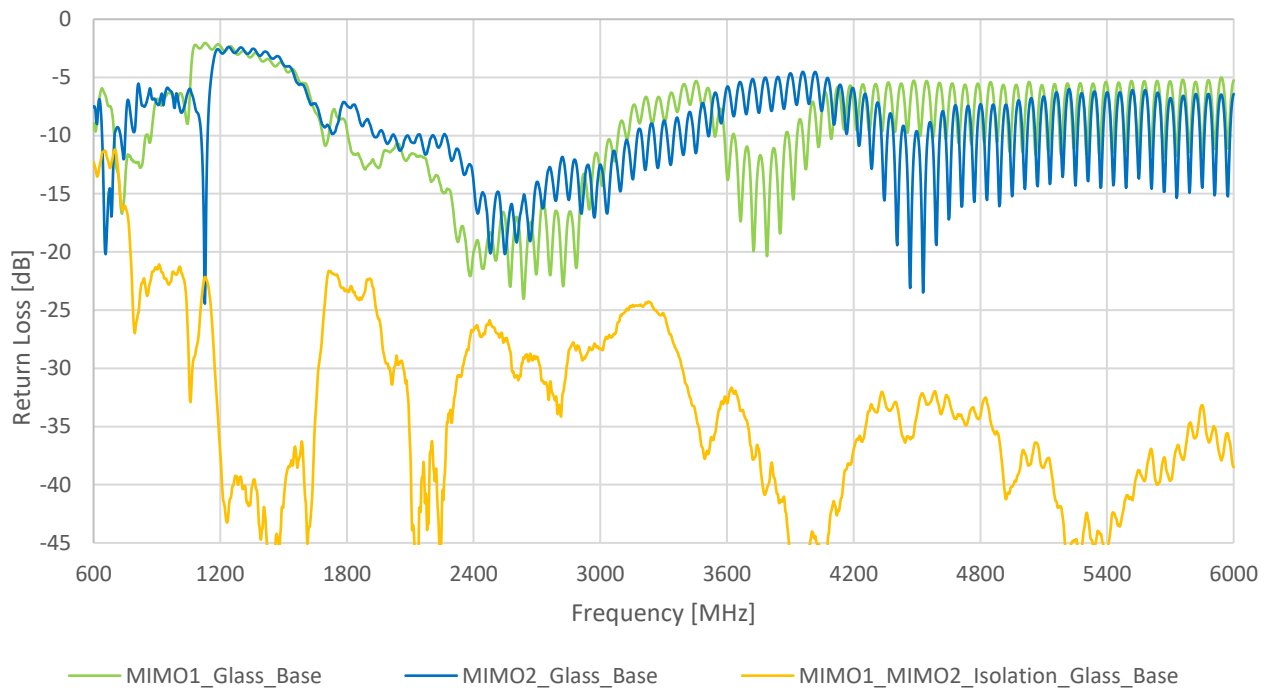

3.4 Efficiency - Freespace

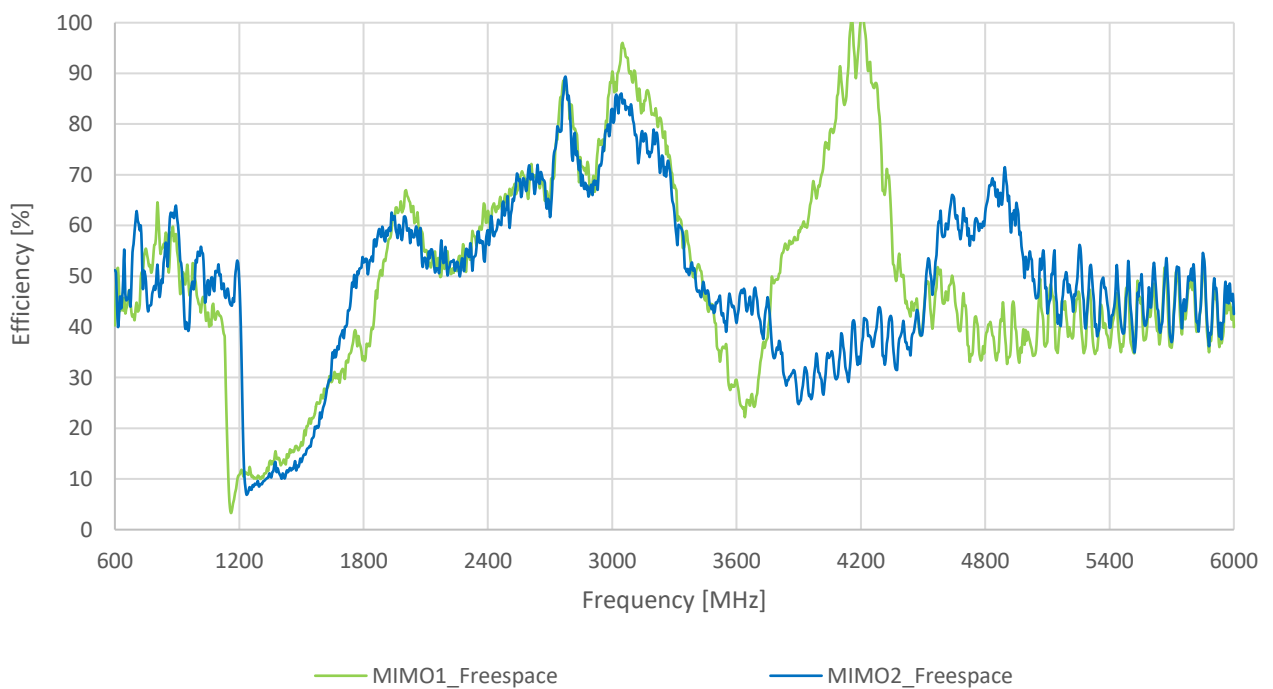

3.5 Efficiency – 2mm ABS

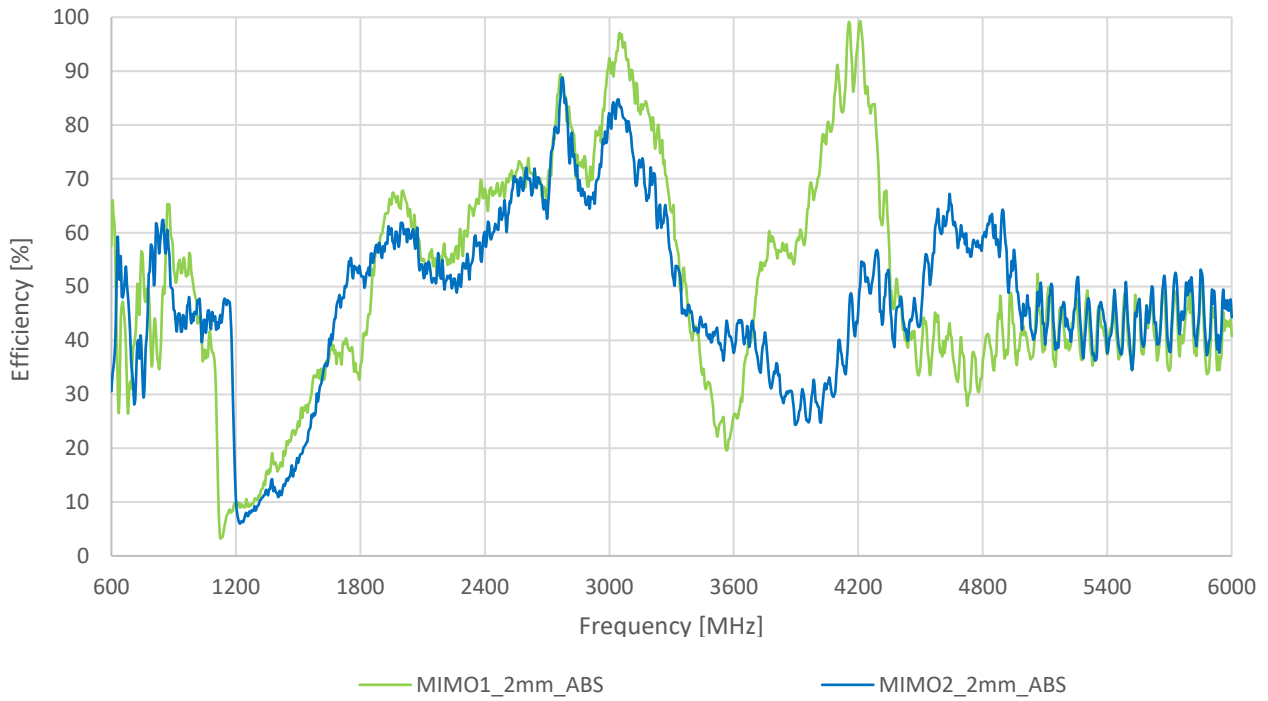

3.6 Efficiency – Glass Base

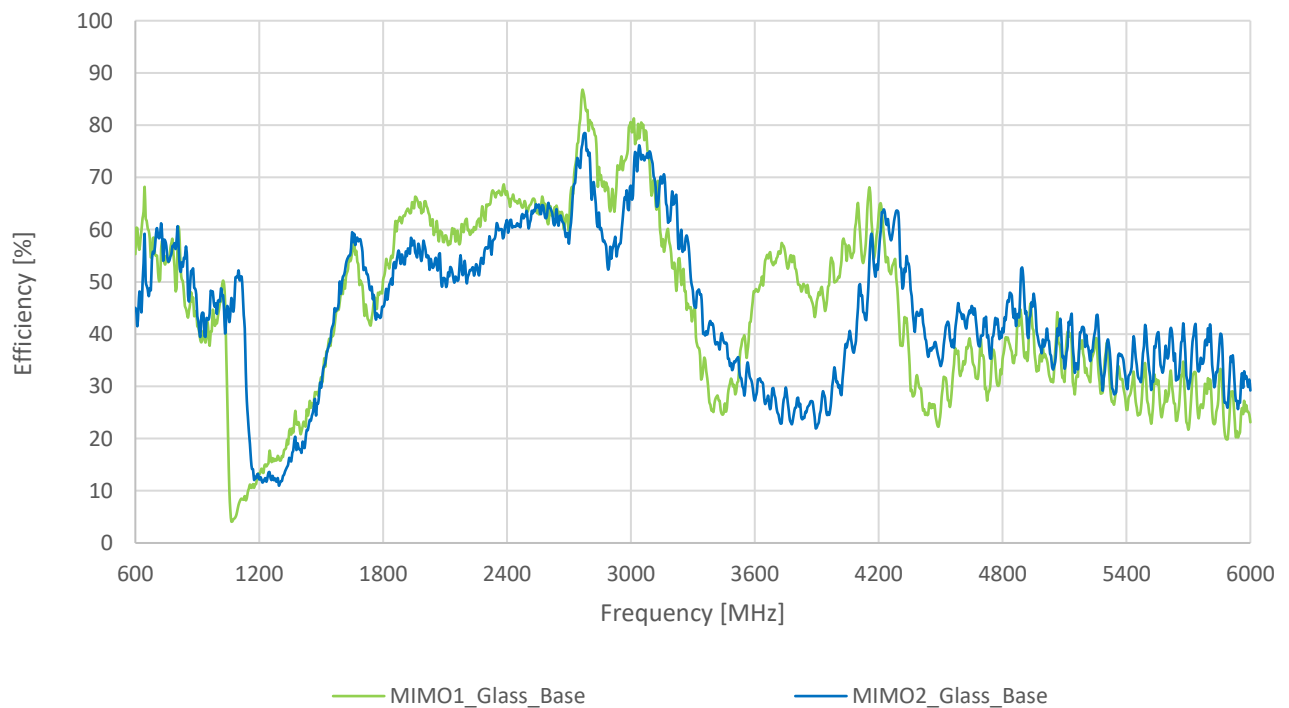

3.5 Average Gain – Freespace

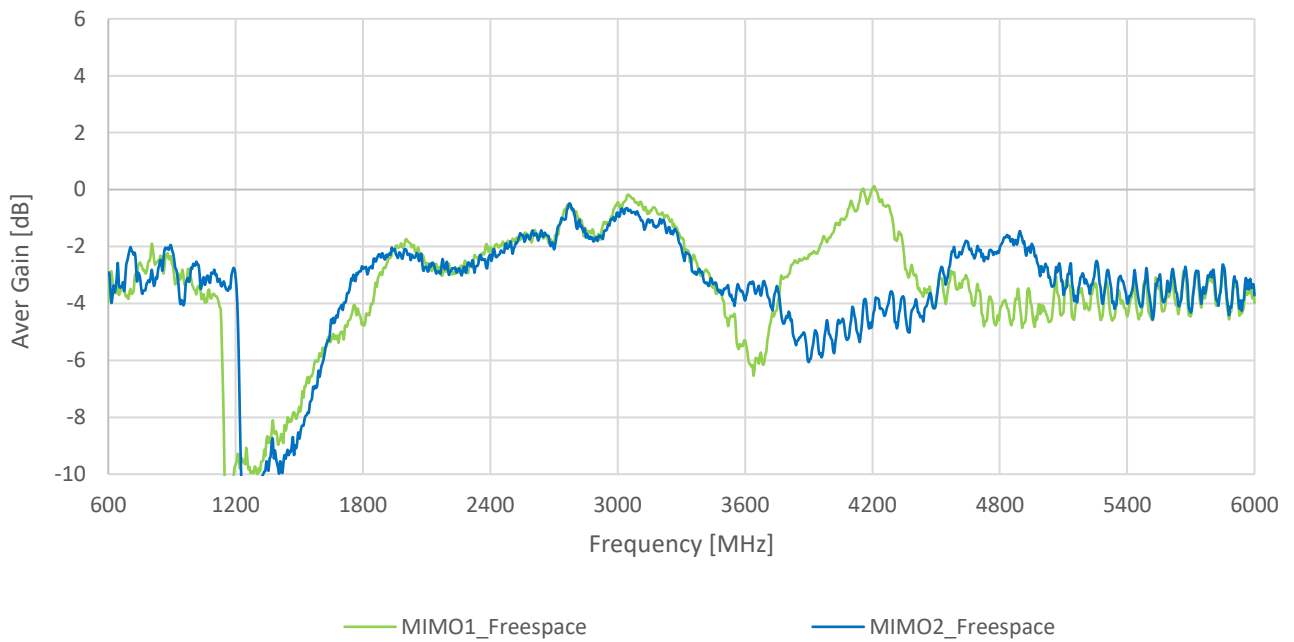

3.6 Average Gain – 2mm ABS

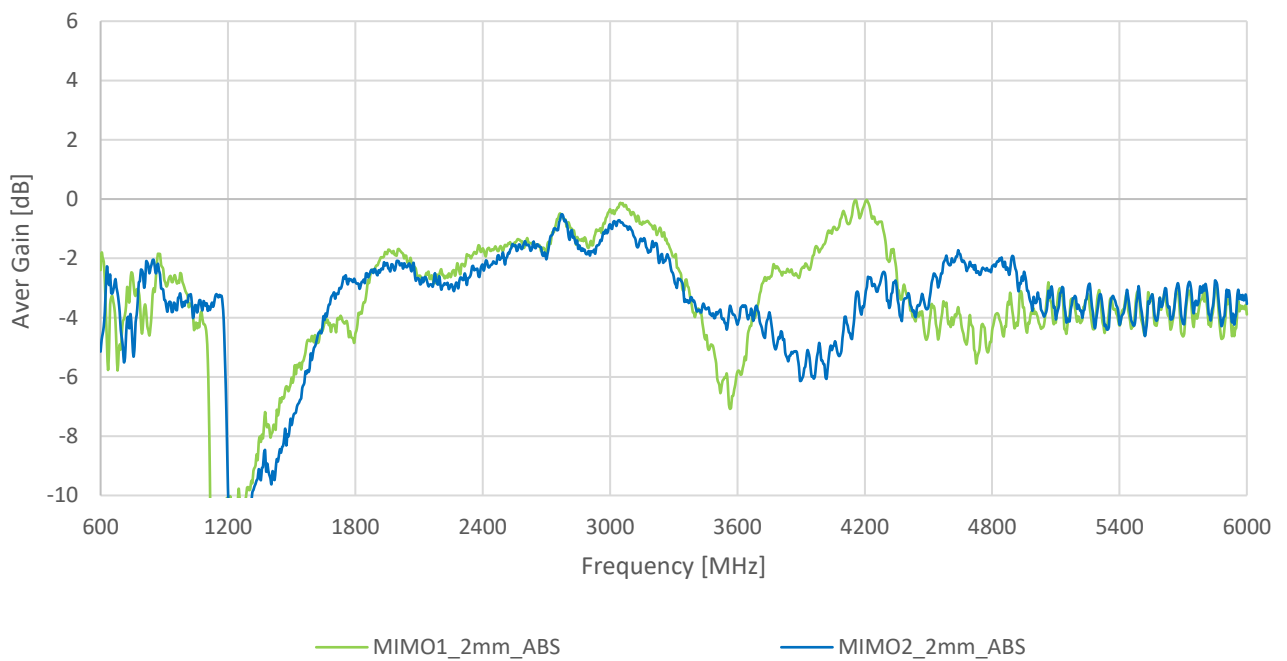

3.5 Average Gain – Glass Base

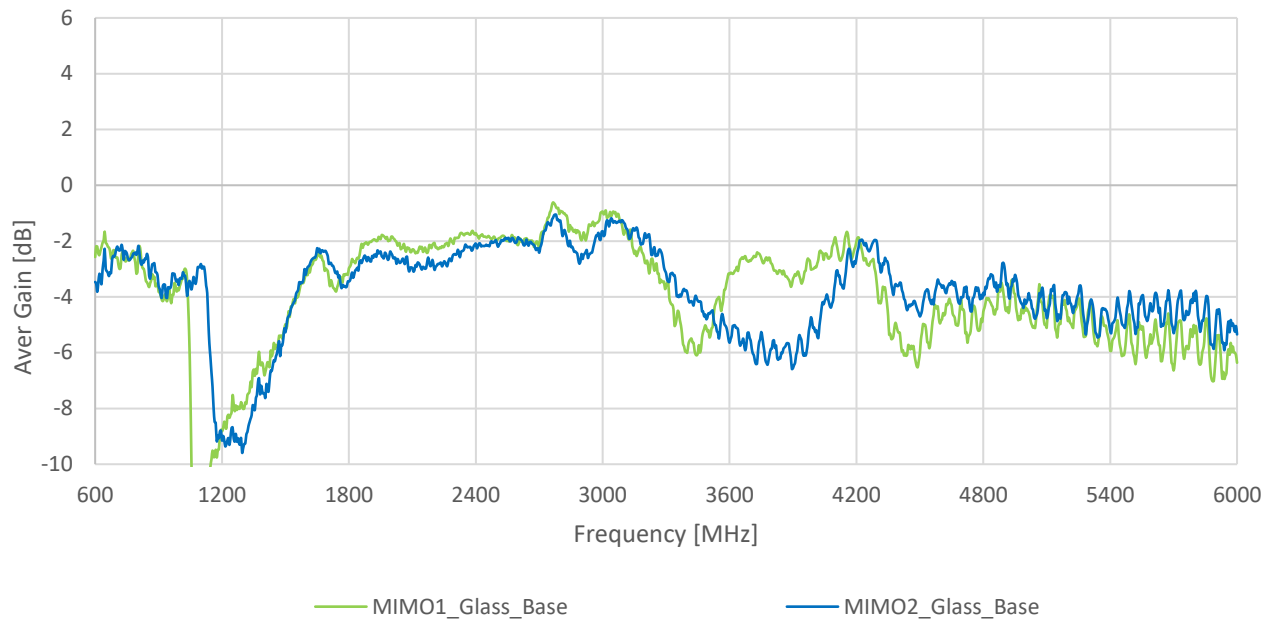

3.6 Peak Gain – Freespace

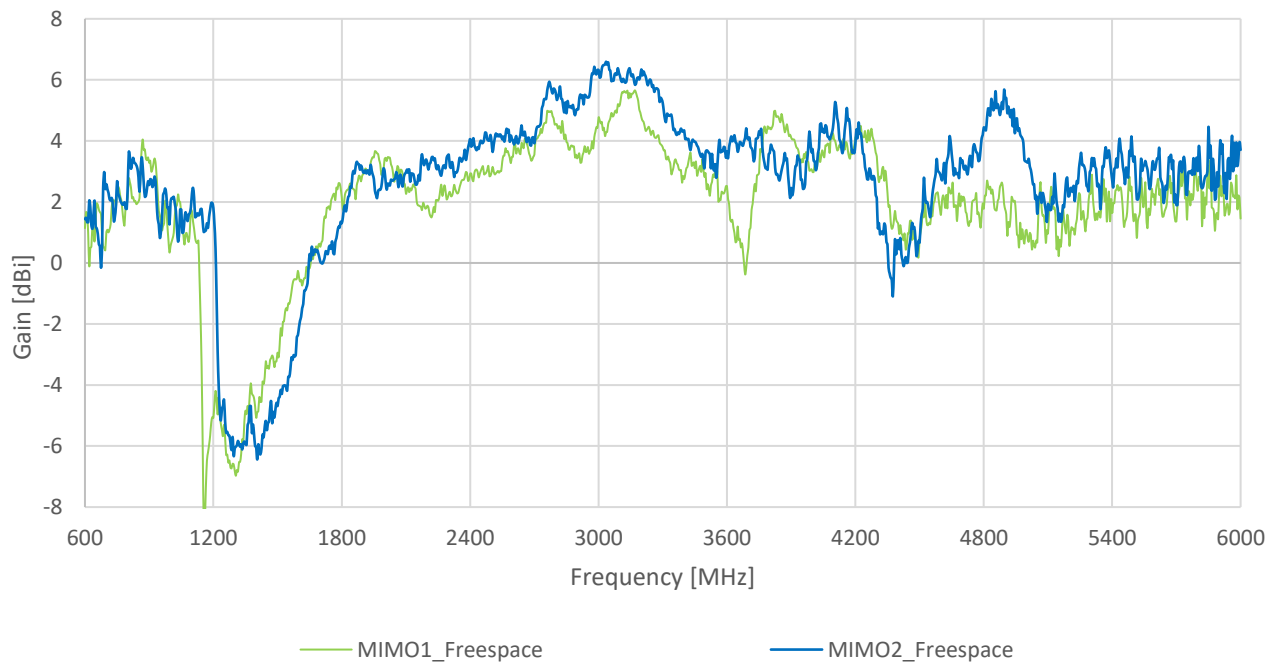

3.5 Peak Gain – 2mm ABS

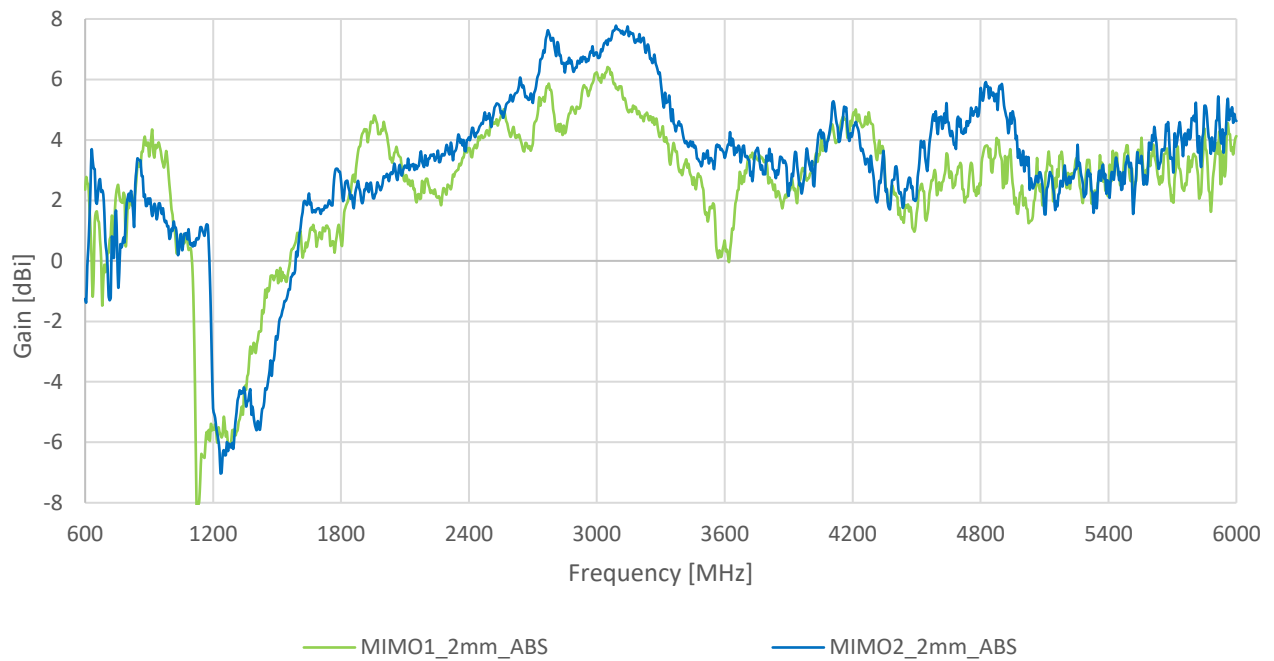

3.6 Peak Gain – Glass Base

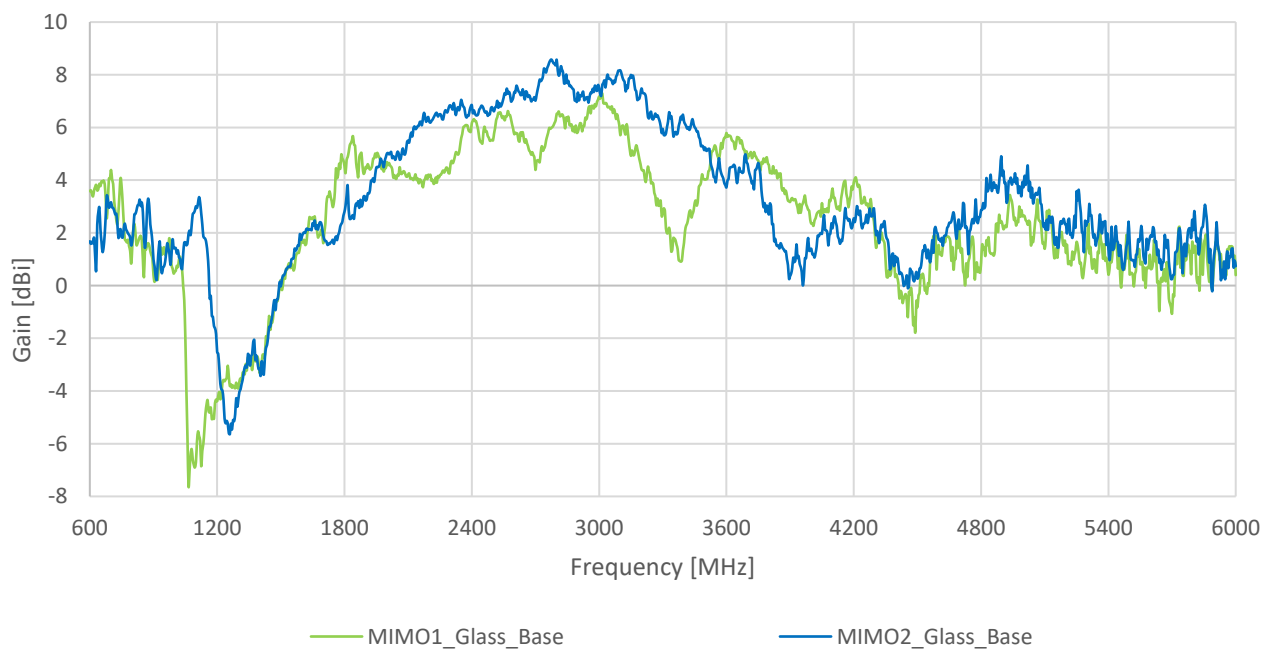

4. Radiation Patterns

4.1 Test Setup – Freespace

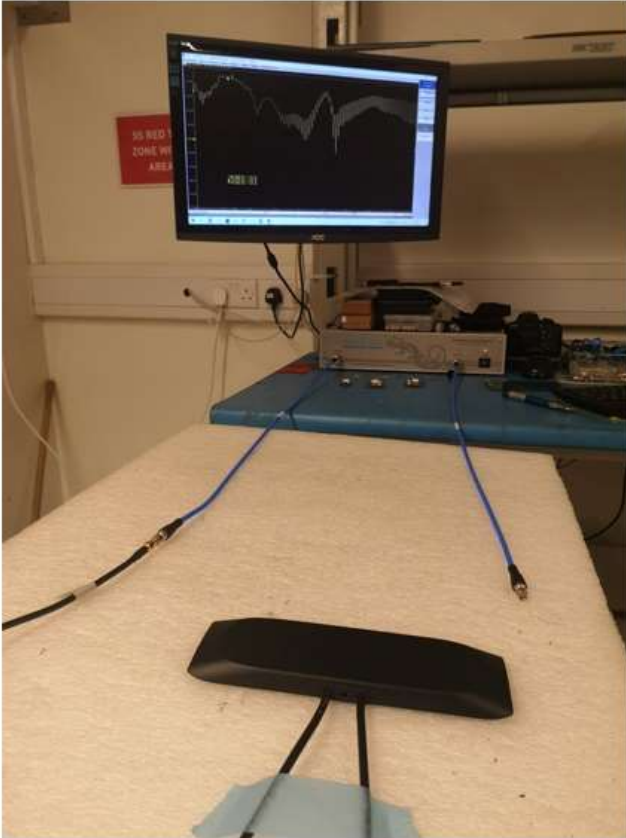

VNA Setup



Chamber Setup

4.2 650MHz_MIMO1_Freespace - 2D & 3D Radiation Patterns

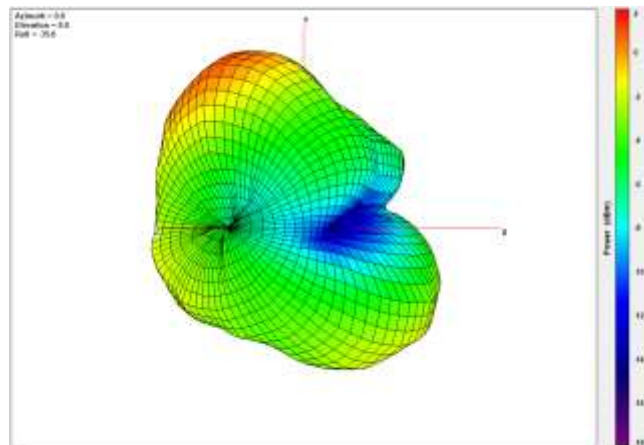

XY Plane

XZ Plane

YZ Plane

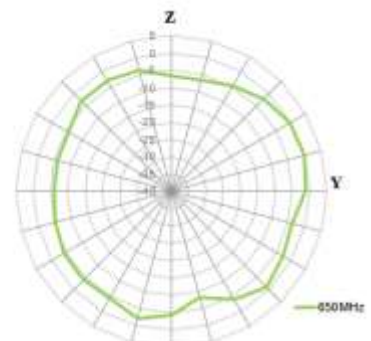
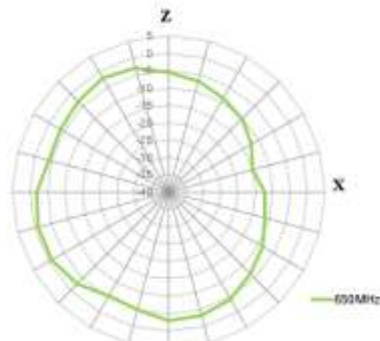
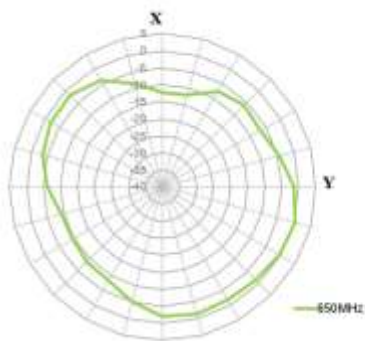

750MHz

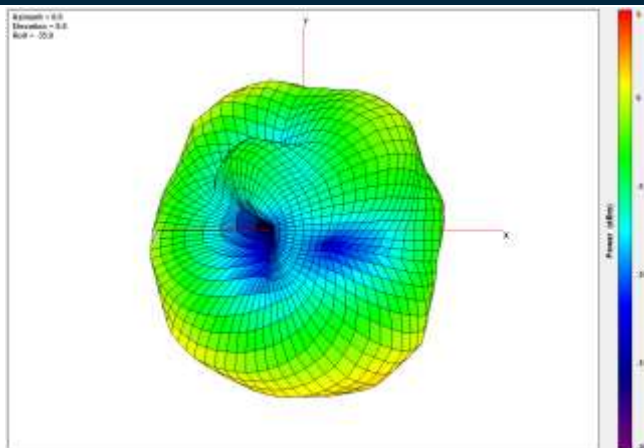

XY Plane

XZ Plane

YZ Plane

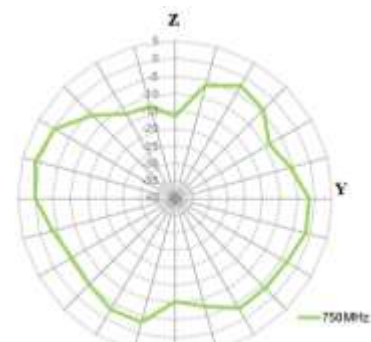
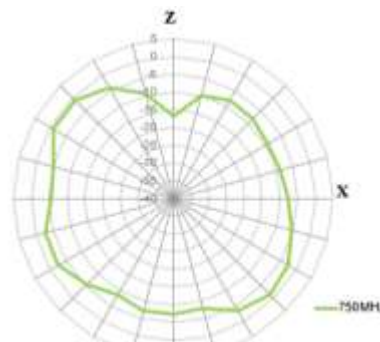
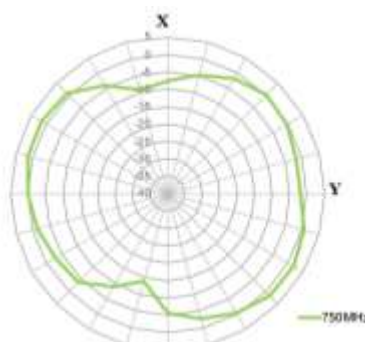

825MHz

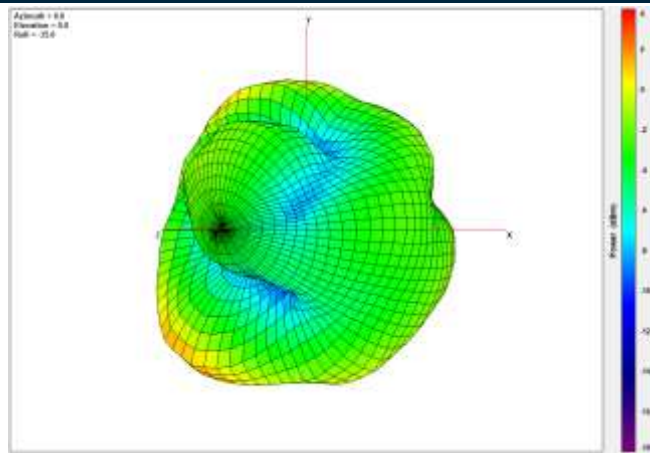

XY Plane

XZ Plane

YZ Plane

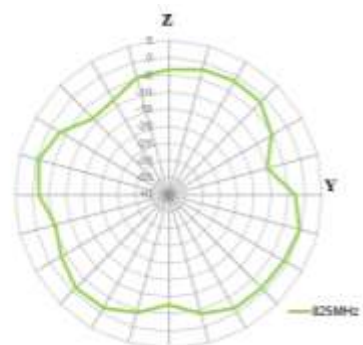
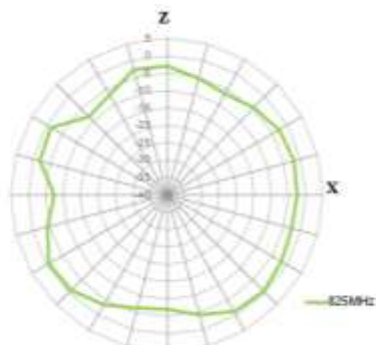
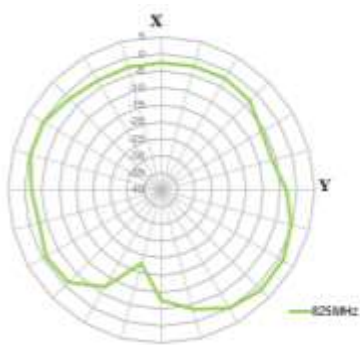

960MHz

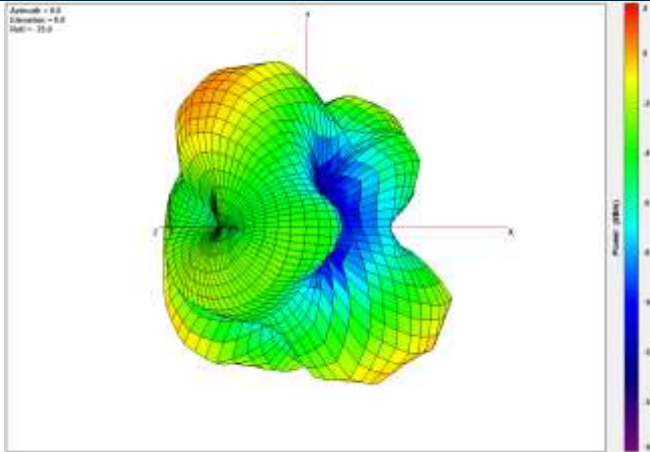

XY Plane

XZ Plane

YZ Plane

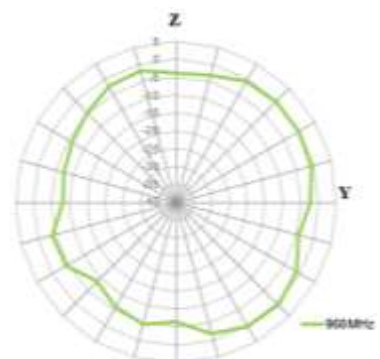
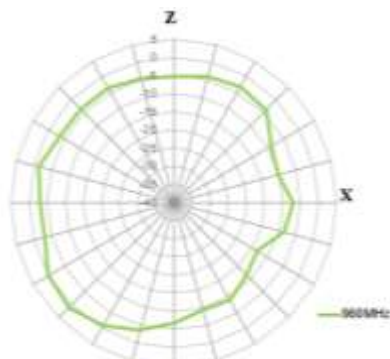
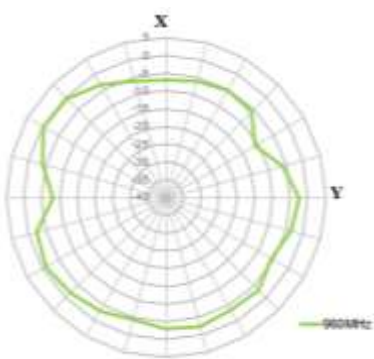

1710MHz

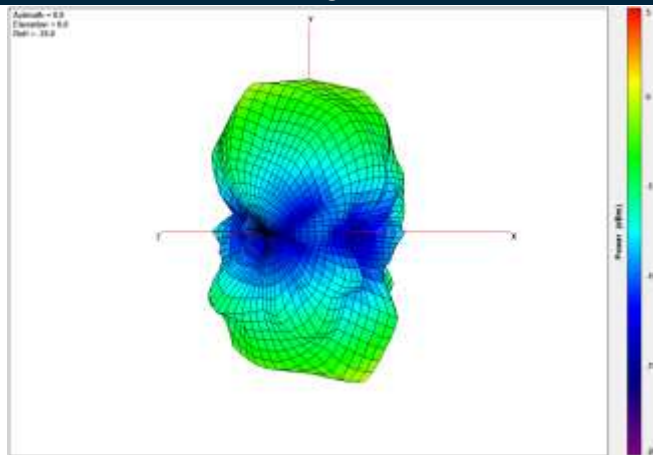

XY Plane

XZ Plane

YZ Plane

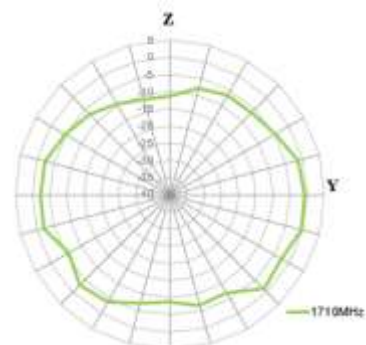
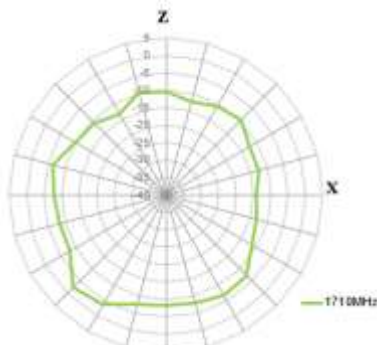
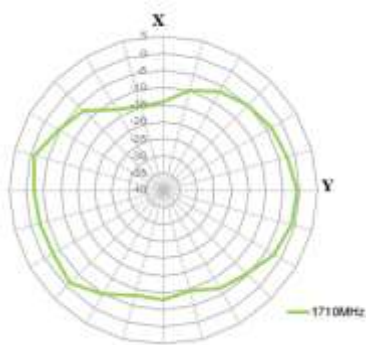

1880MHz

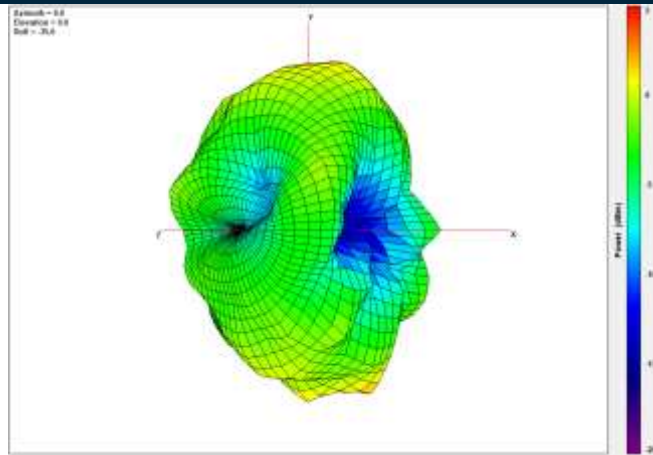

XY Plane

XZ Plane

YZ Plane

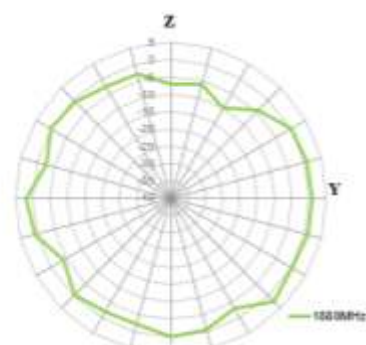
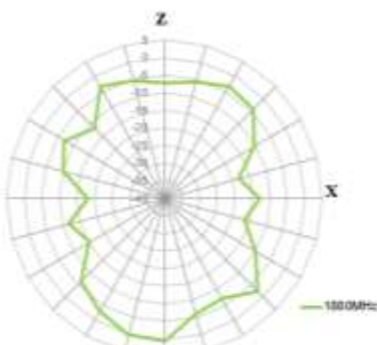
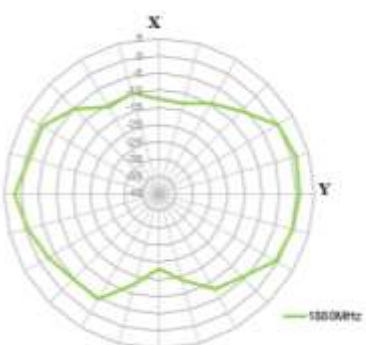

1990MHz

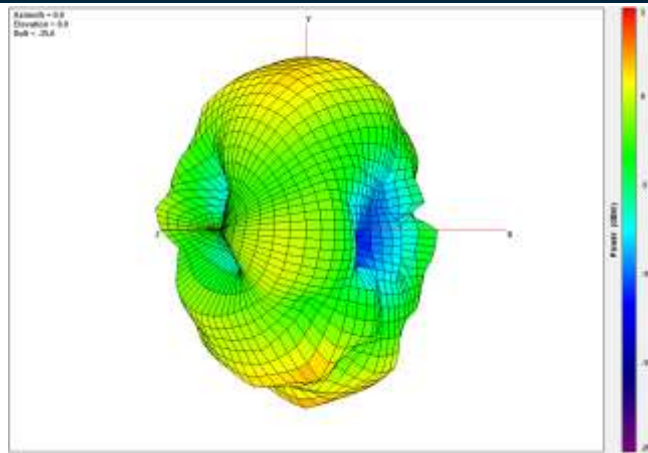

XY Plane

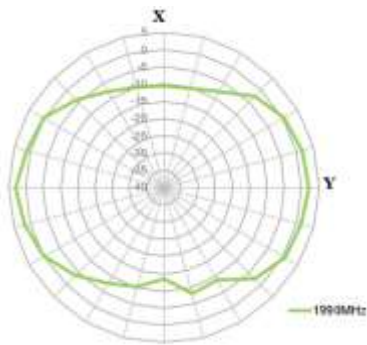

XZ Plane

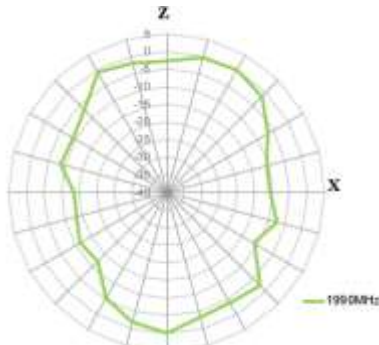

YZ Plane

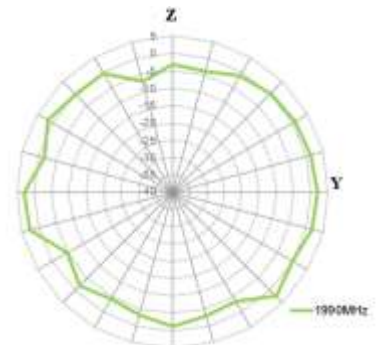

2170MHz

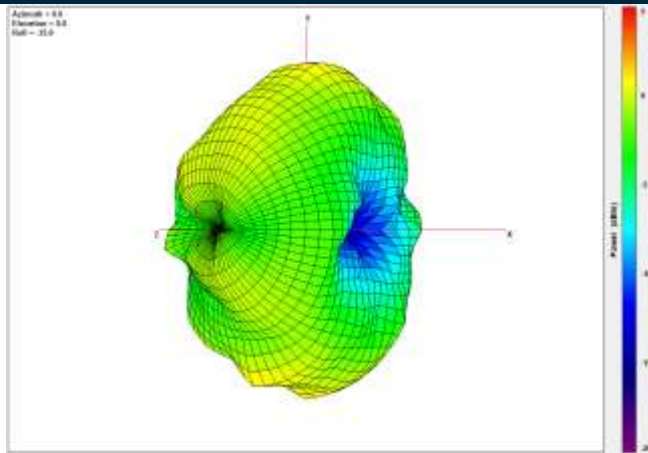

XY Plane

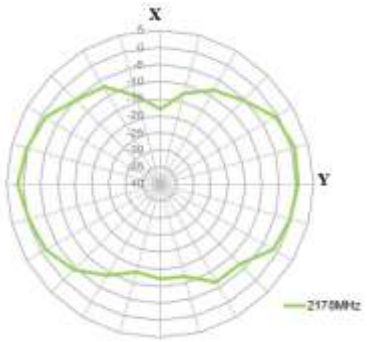

XZ Plane

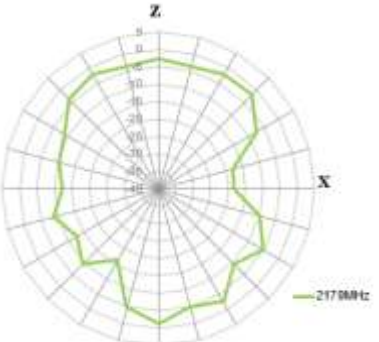

YZ Plane

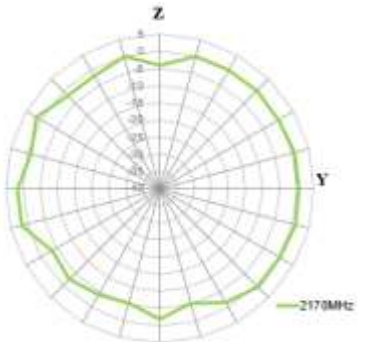

2300MHz

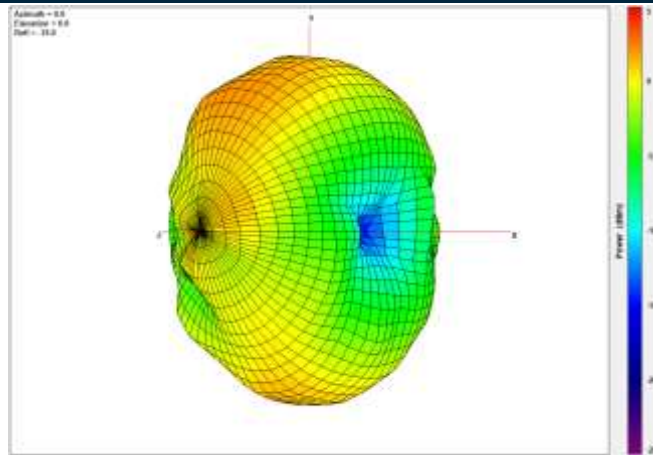

XY Plane

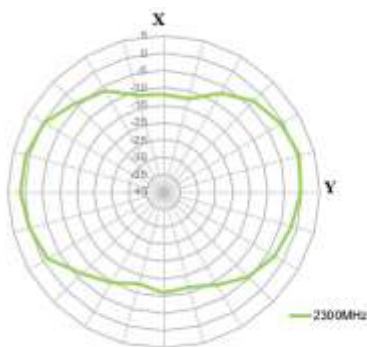

XZ Plane

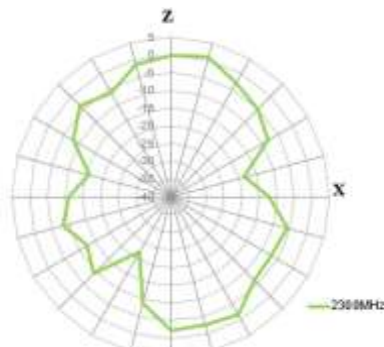

YZ Plane

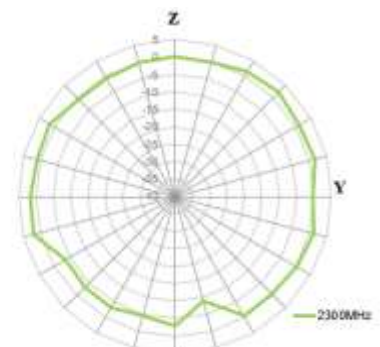

2690MHz

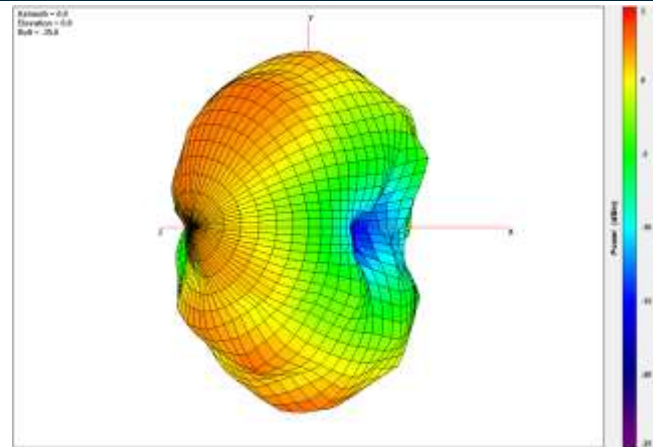

XY Plane

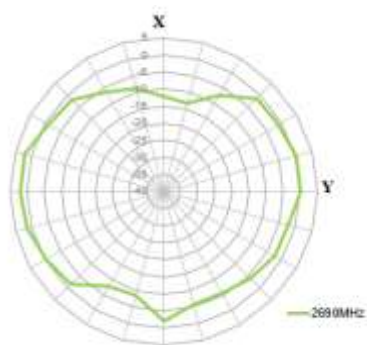

XZ Plane

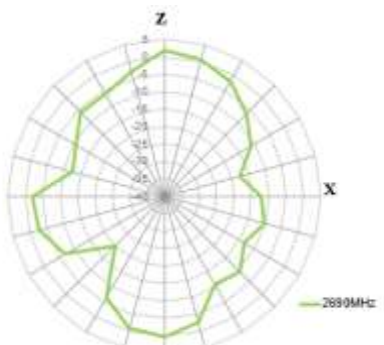

YZ Plane

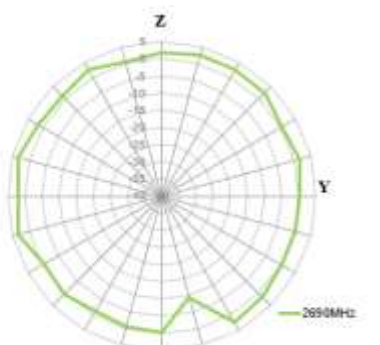

3400MHz

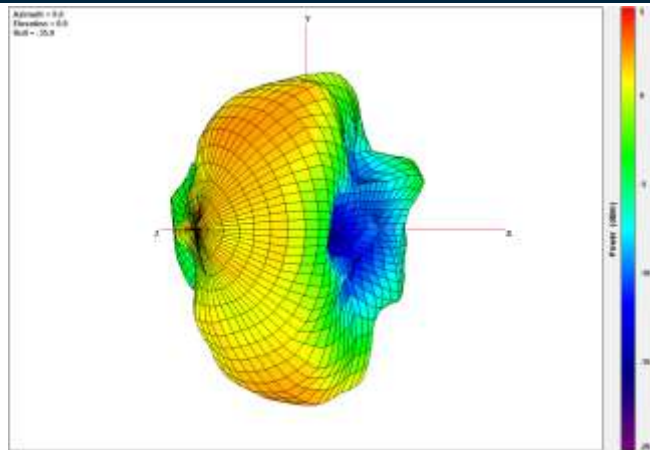

XY Plane

XZ Plane

YZ Plane

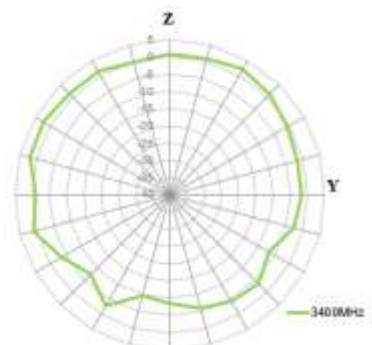
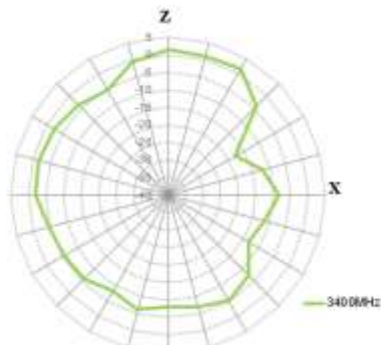
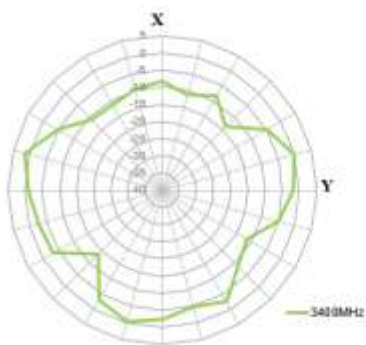

3800MHz

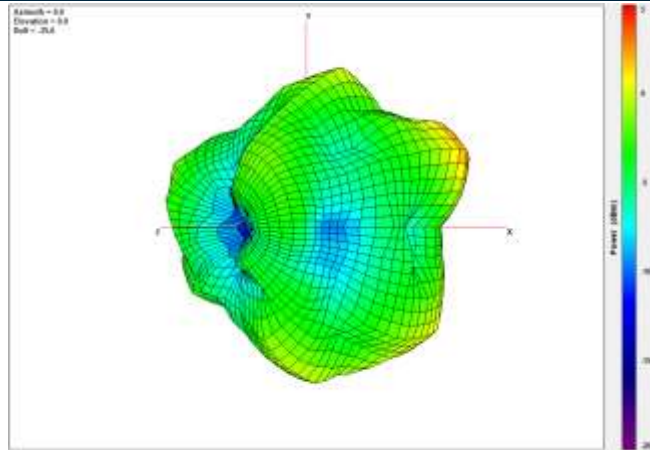

XY Plane

XZ Plane

YZ Plane

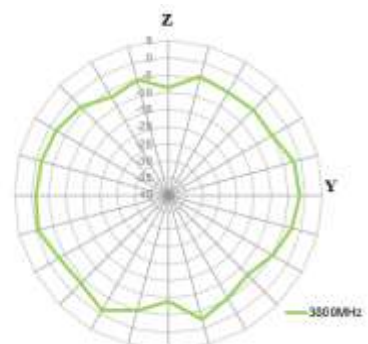
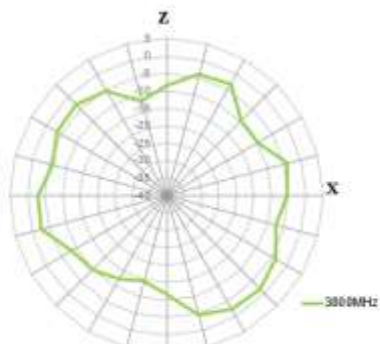
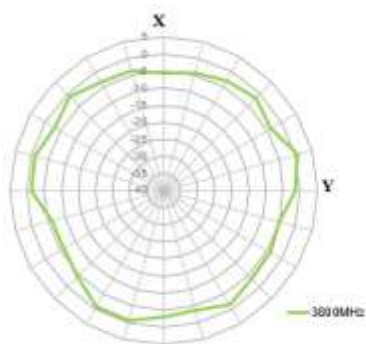

5550MHz

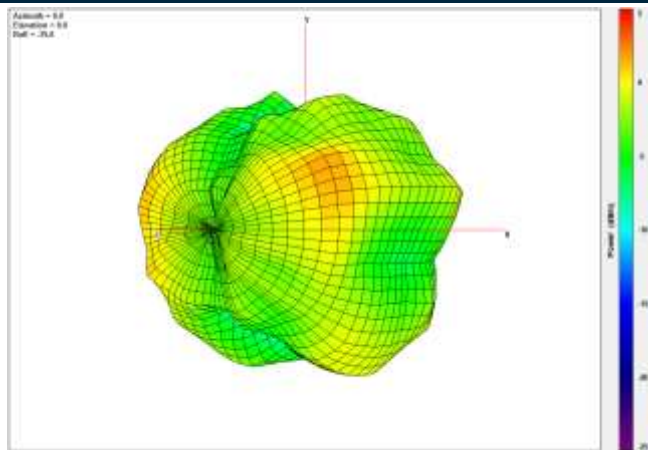

XY Plane

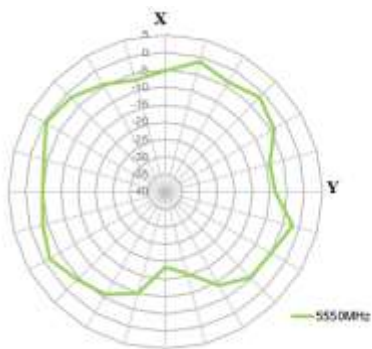

XZ Plane

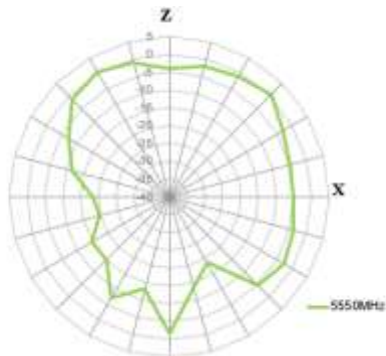

YZ Plane

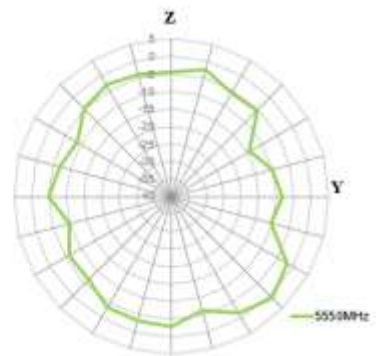

4.3 650MHz_MIMO2_Freespace - 2D & 3D Radiation Patterns

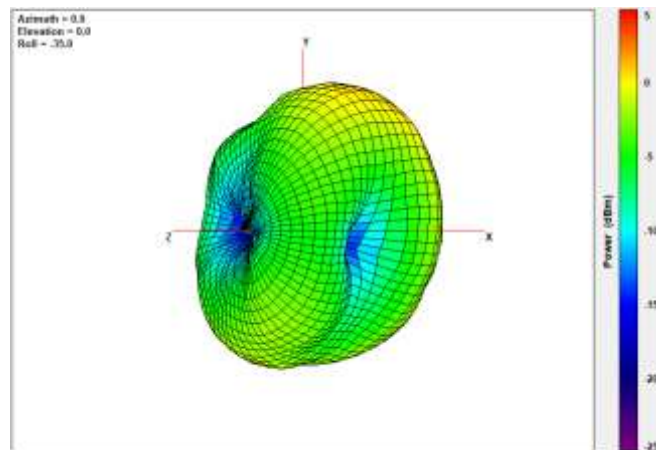

XY Plane

XZ Plane

YZ Plane

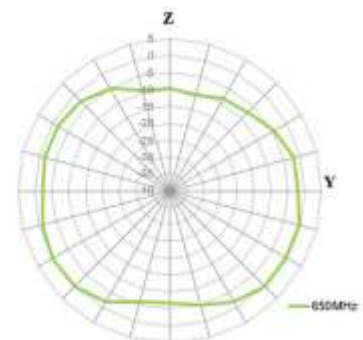
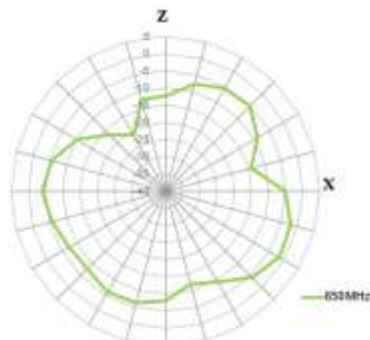

750MHz

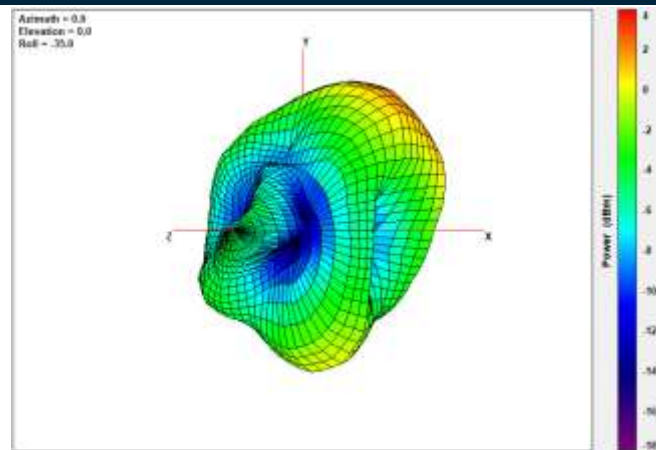

XY Plane

XZ Plane

YZ Plane

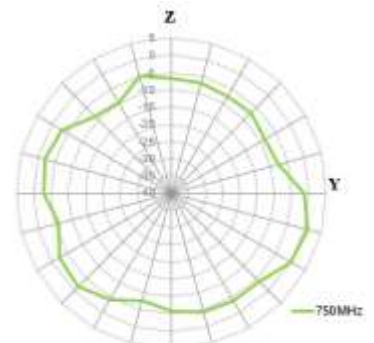
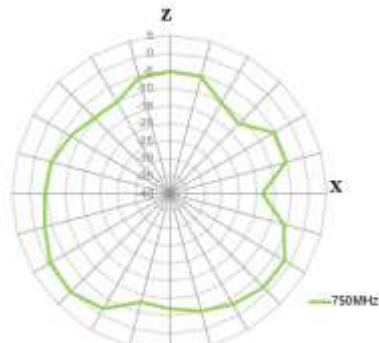
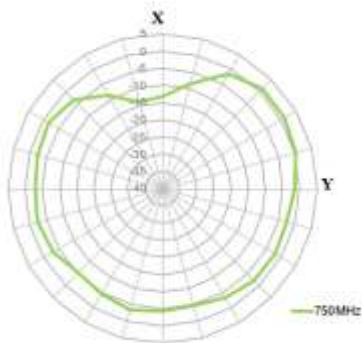

825MHz

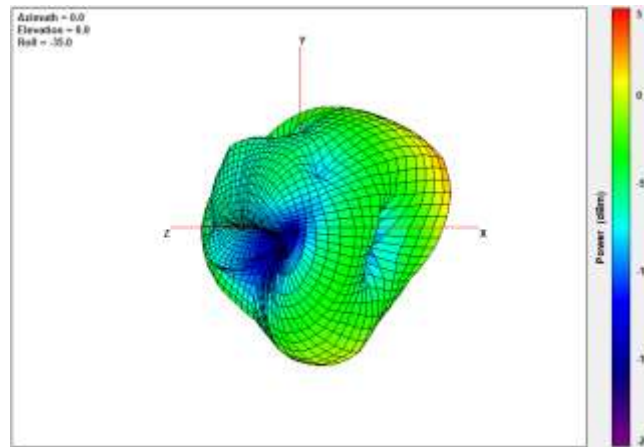

XY Plane

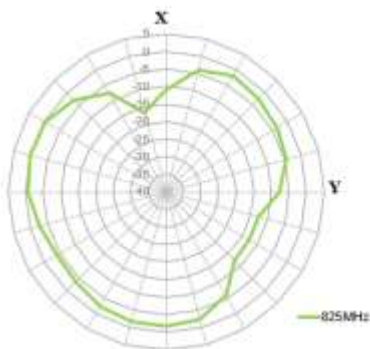

XZ Plane

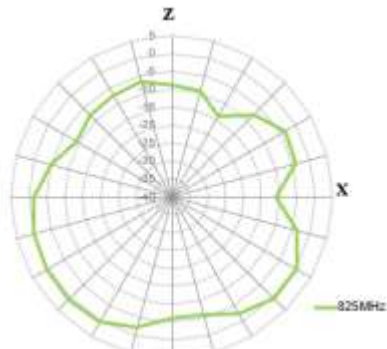

YZ Plane

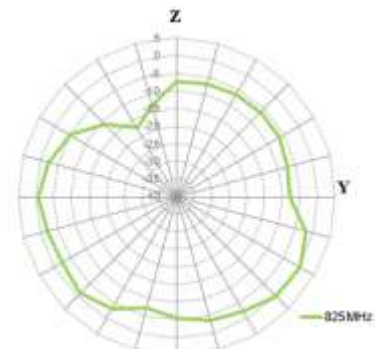

960MHz

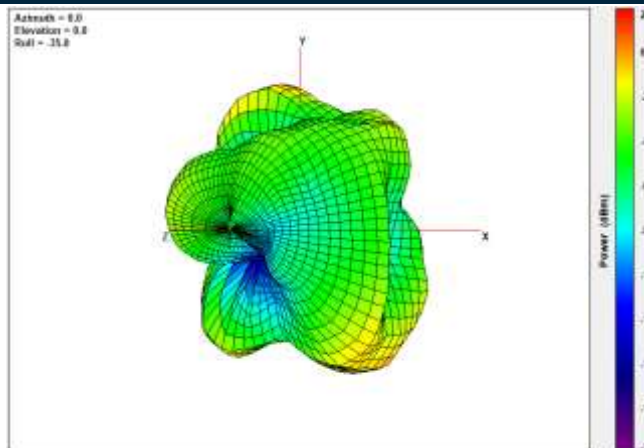

XY Plane

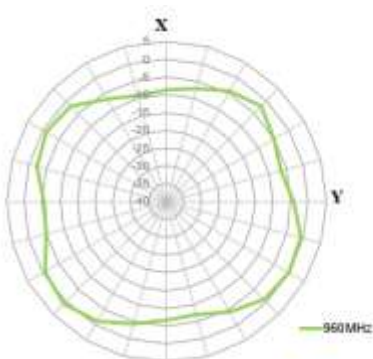

XZ Plane

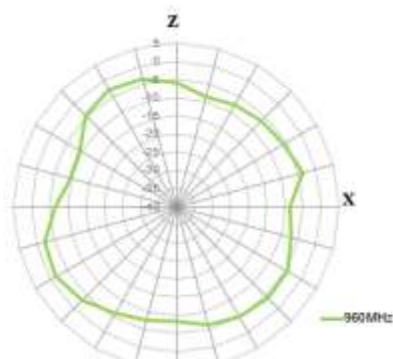

YZ Plane

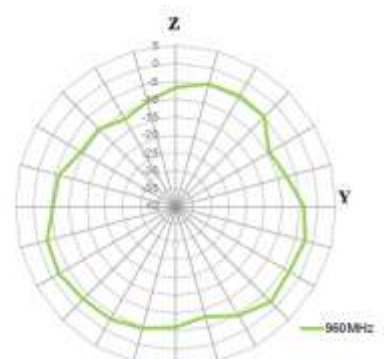

1710MHz

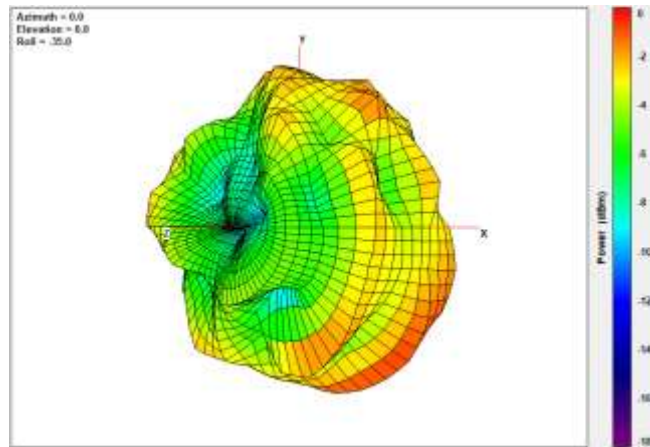

XY Plane

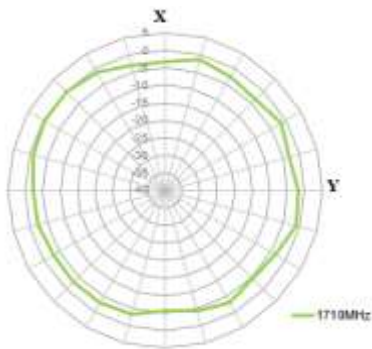

XZ Plane

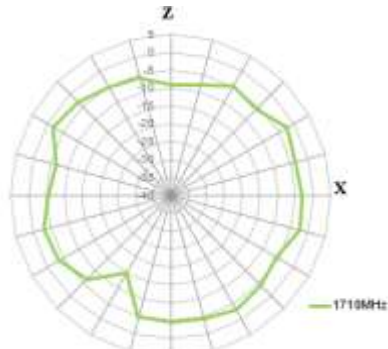

YZ Plane

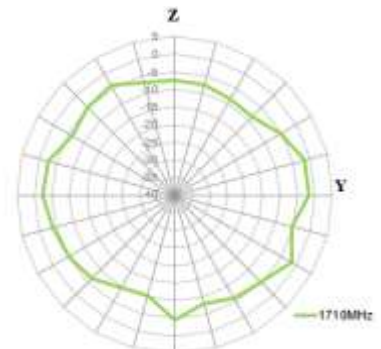

1880MHz

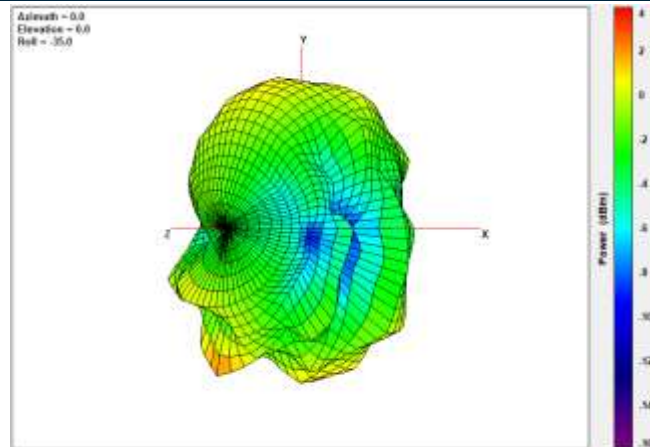

XY Plane

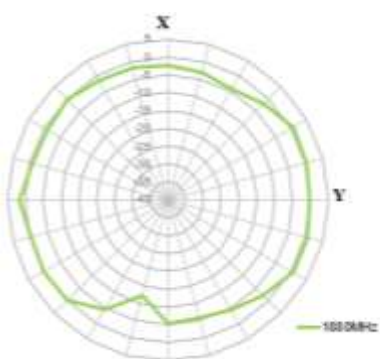

XZ Plane

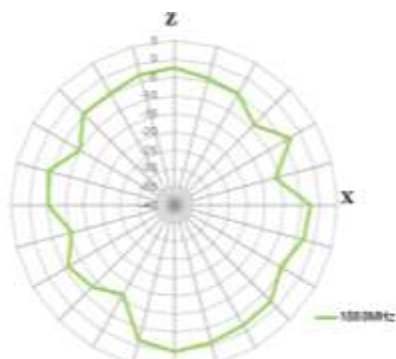

YZ Plane

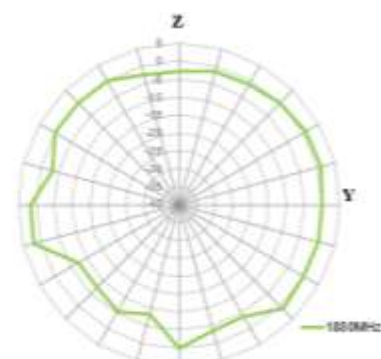

1990MHz

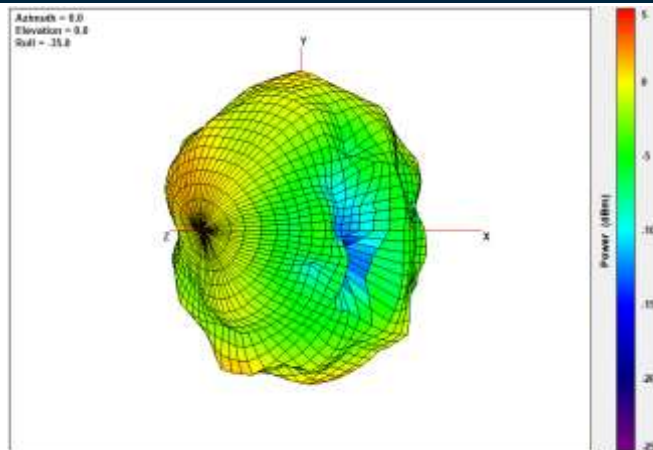

XY Plane

XZ Plane

YZ Plane

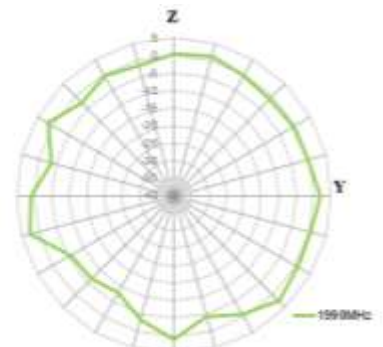
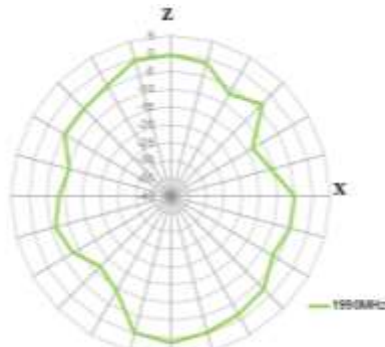
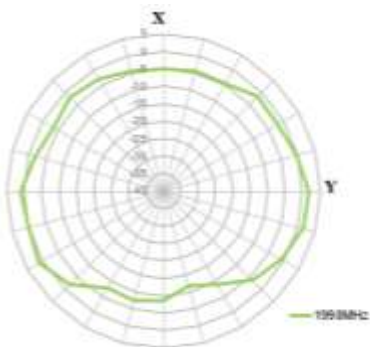

2170MHz

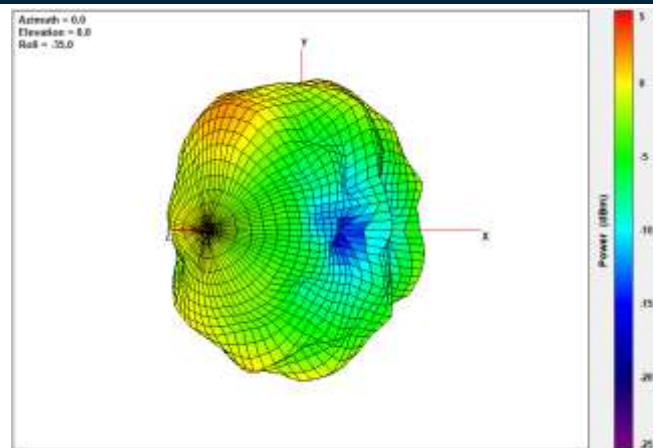

XY Plane

XZ Plane

YZ Plane

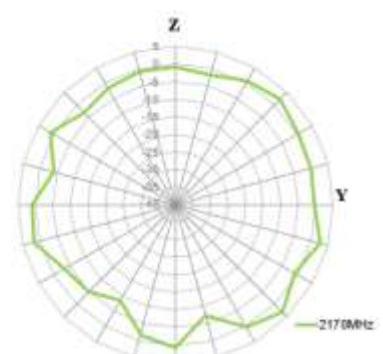
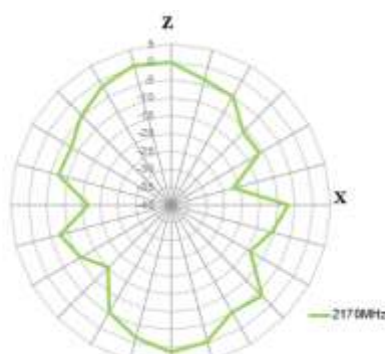
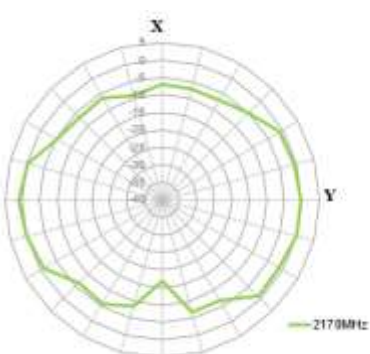

2300MHz

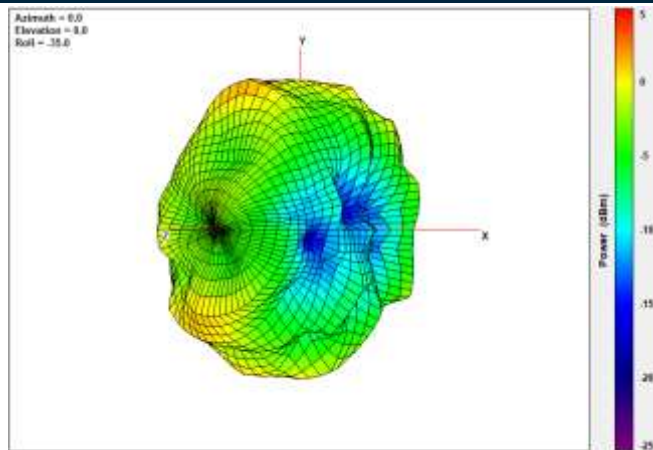

XY Plane

XZ Plane

YZ Plane

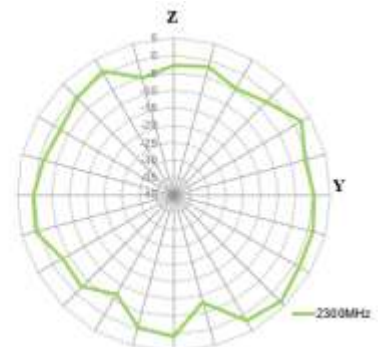
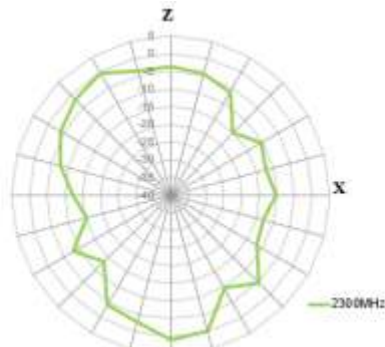
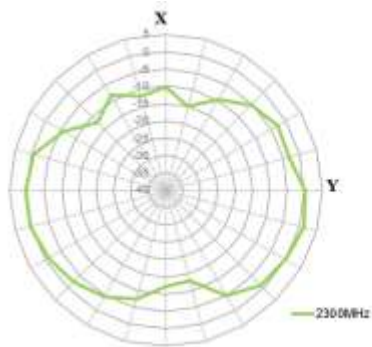

2690MHz

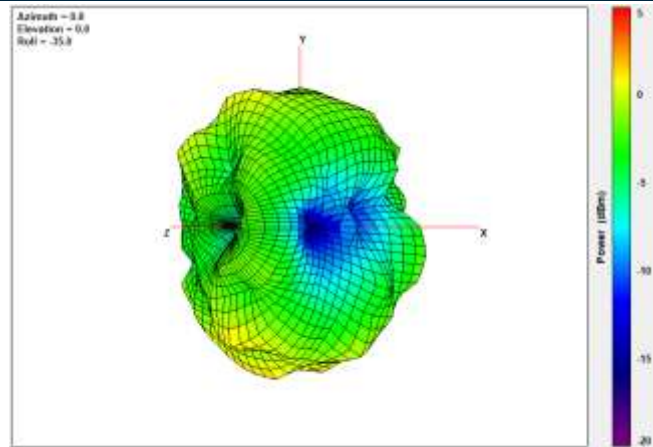

XY Plane

XZ Plane

YZ Plane

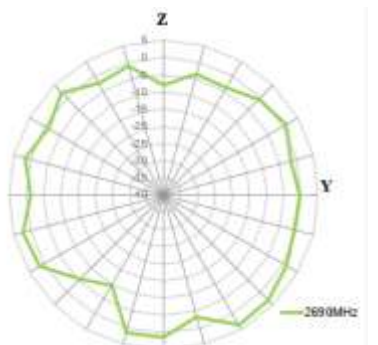
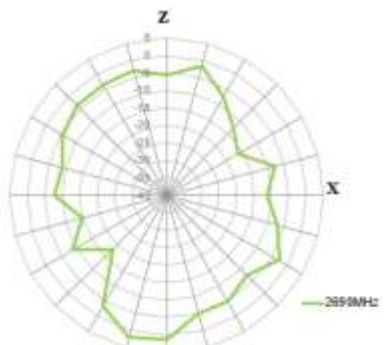
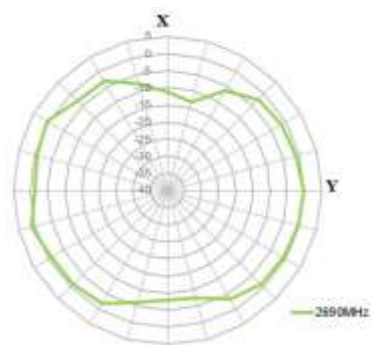

3400MHz

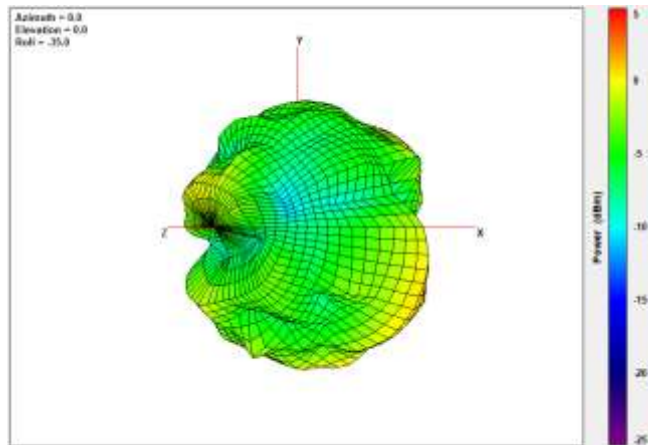

XY Plane

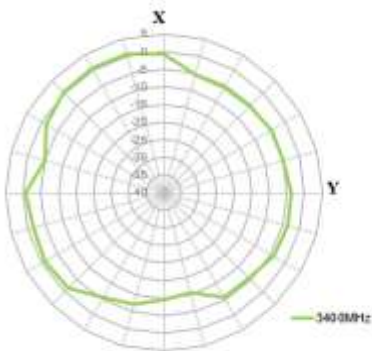

XZ Plane

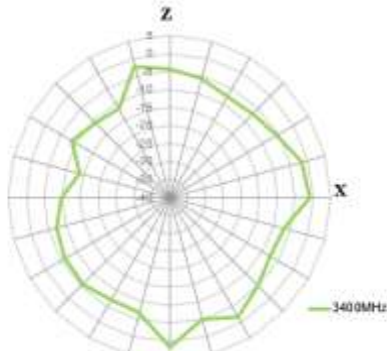

YZ Plane

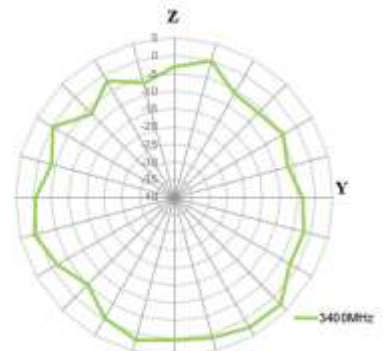

3800MHz

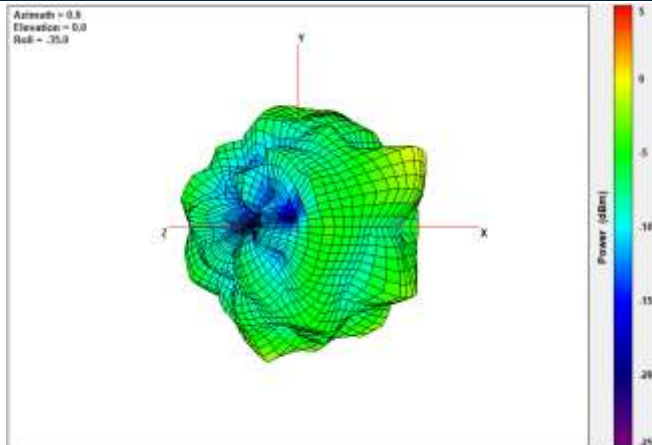

XY Plane

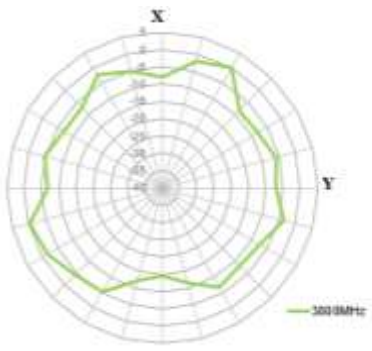

XZ Plane

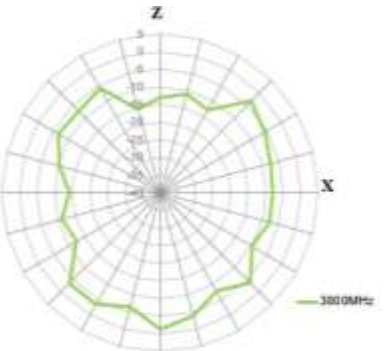

YZ Plane

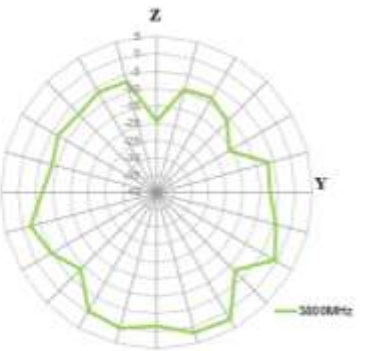

5550MHz

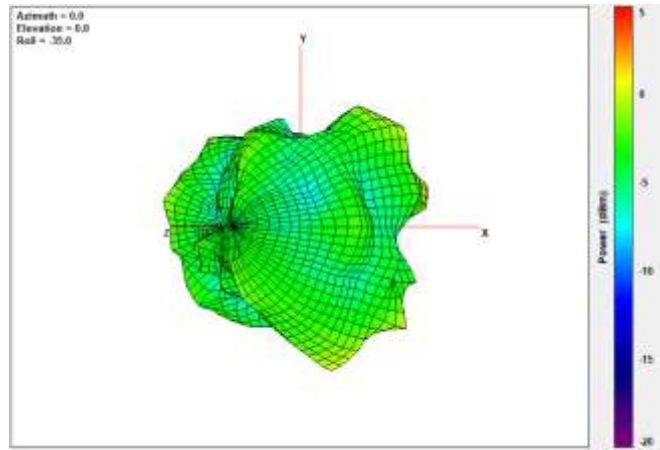

XY Plane

XZ Plane

YZ Plane

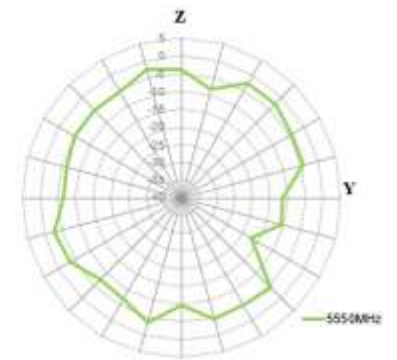
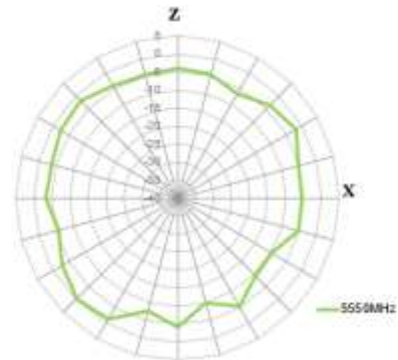
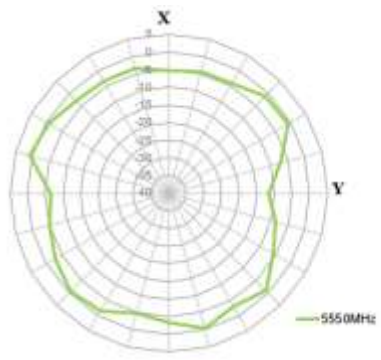

4.4 Test Setup – 2mm ABS

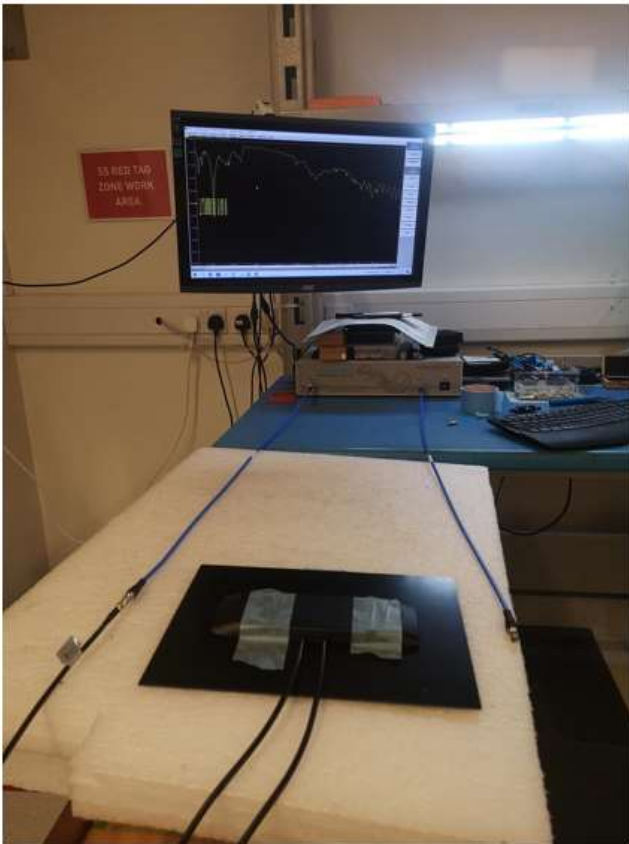

VNA Setup



Chamber Setup

4.5 650MHz _MIMO1_2mm ABS - 2D & 3D Radiation Patterns

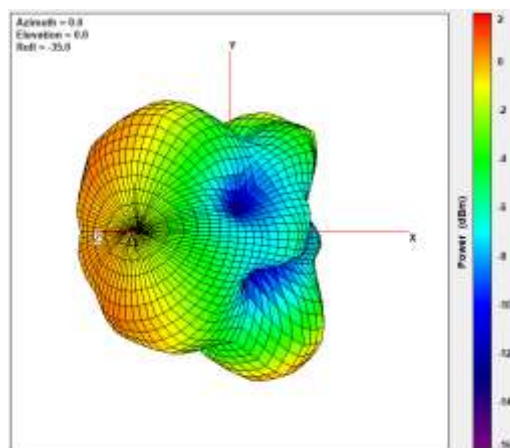

XY Plane

XZ Plane

YZ Plane

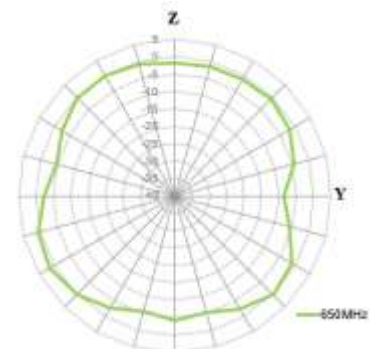
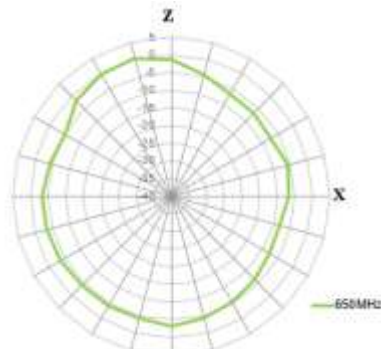
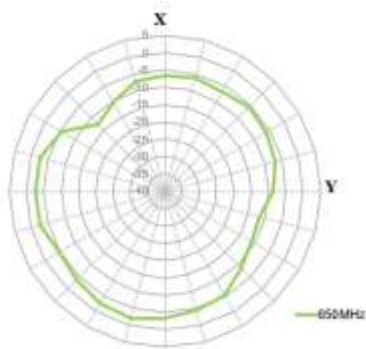

750MHz

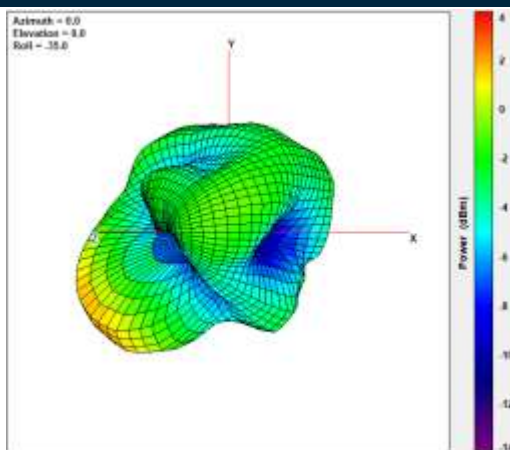

XY Plane

XZ Plane

YZ Plane

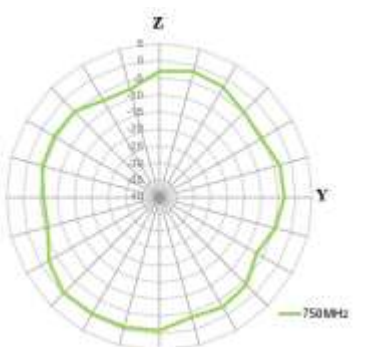
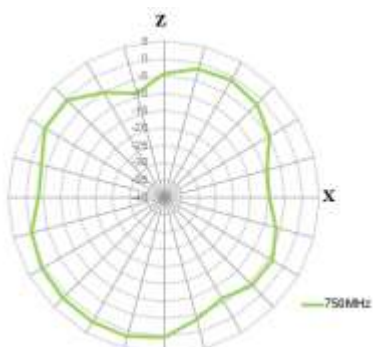
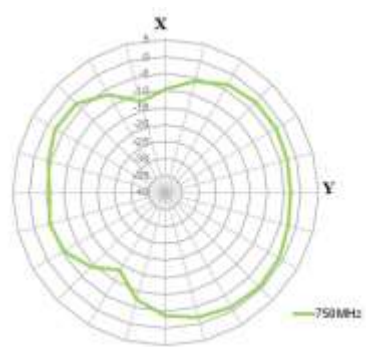

825MHz

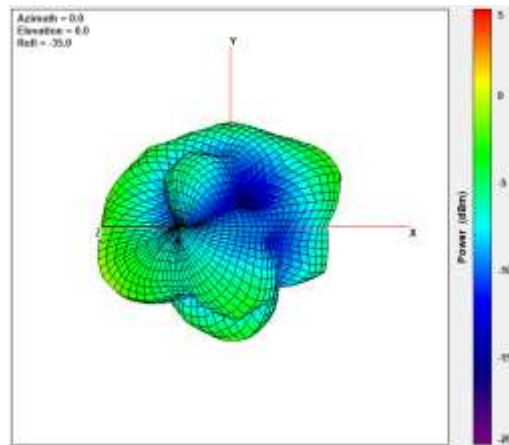

XY Plane

XZ Plane

YZ Plane

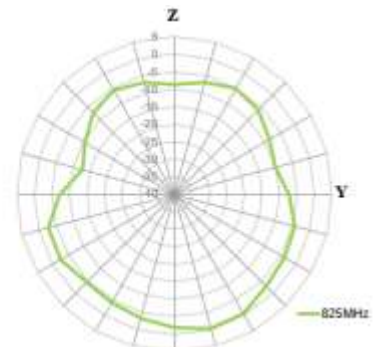
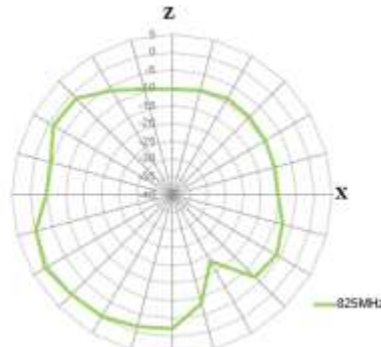
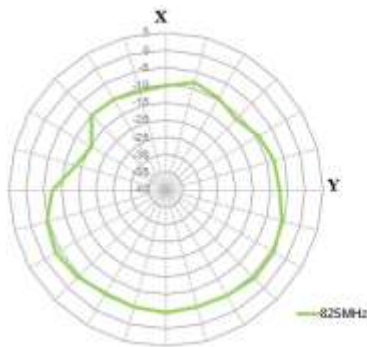

960MHz

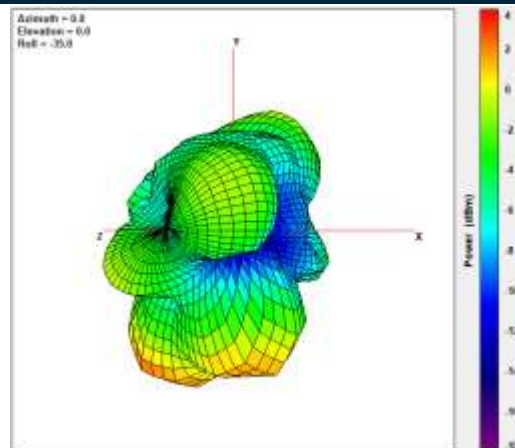

XY Plane

XZ Plane

YZ Plane

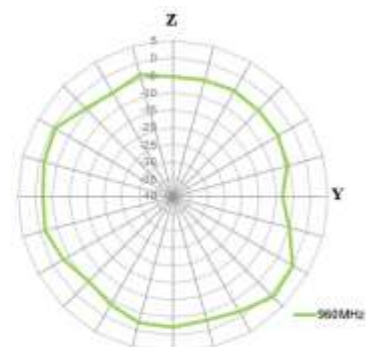
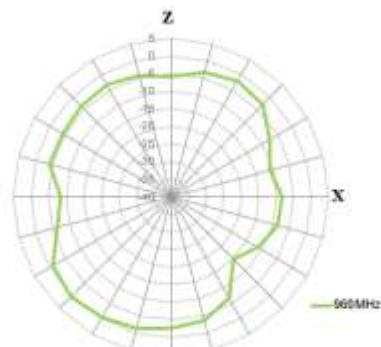
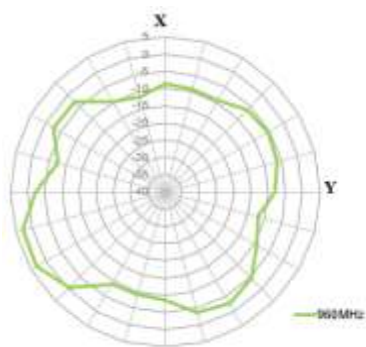

1710MHz

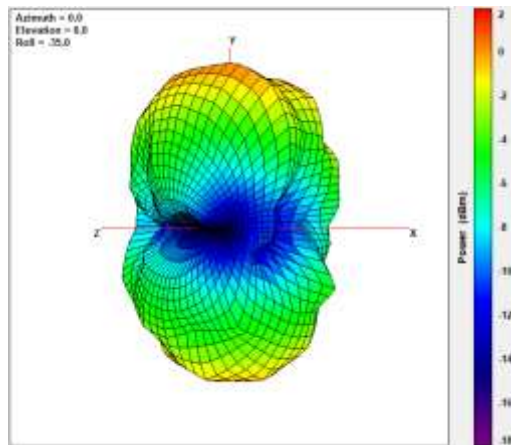

XY Plane

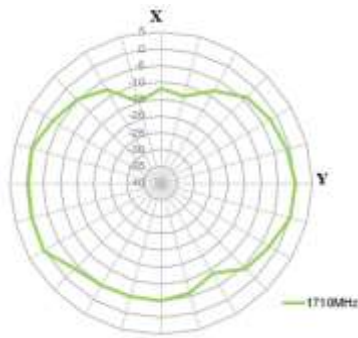

XZ Plane

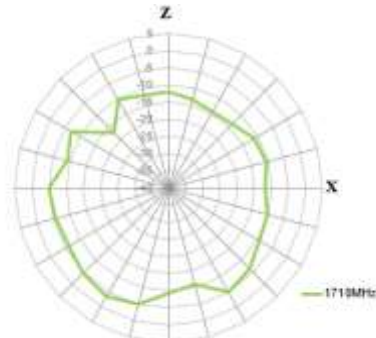

YZ Plane

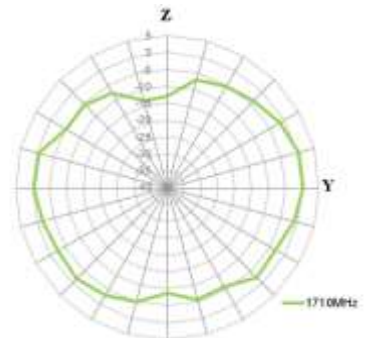

1880MHz

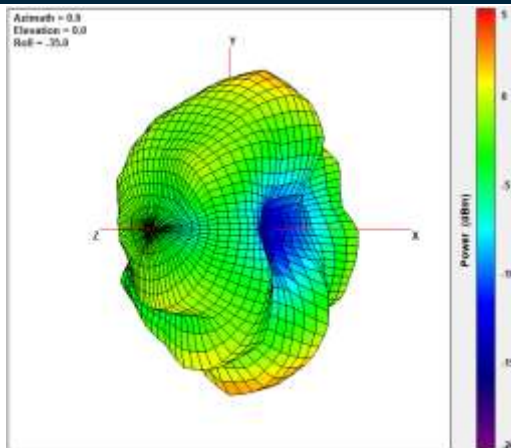

XY Plane

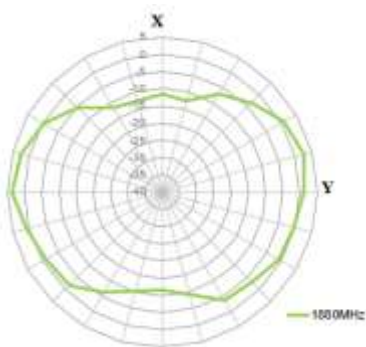

XZ Plane

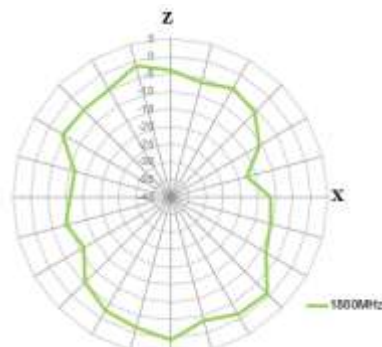

YZ Plane

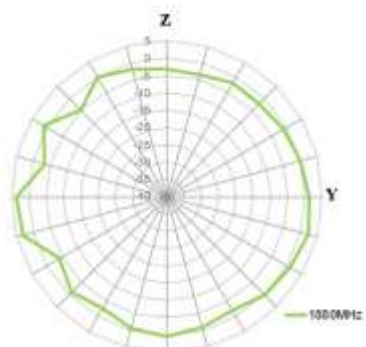

1990MHz

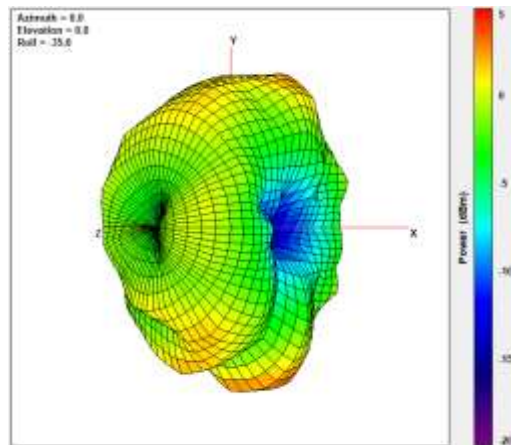

XY Plane

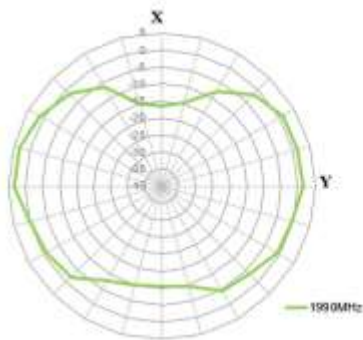

XZ Plane

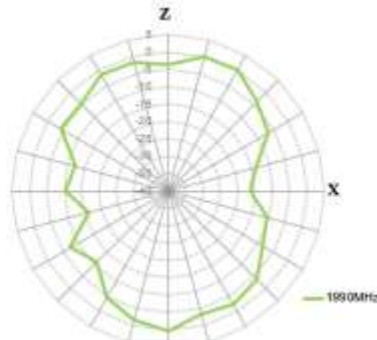

YZ Plane

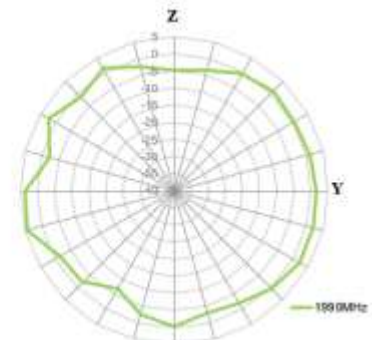

2170MHz

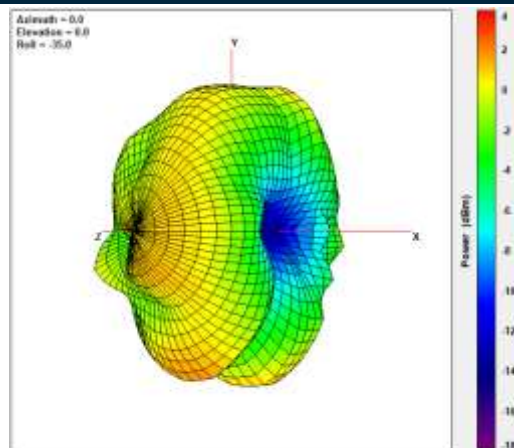

XY Plane

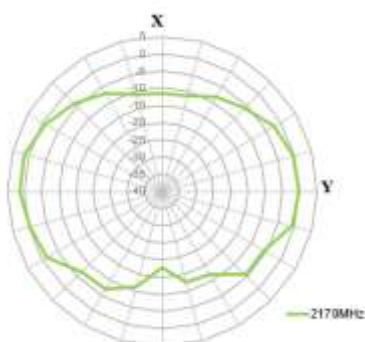

XZ Plane

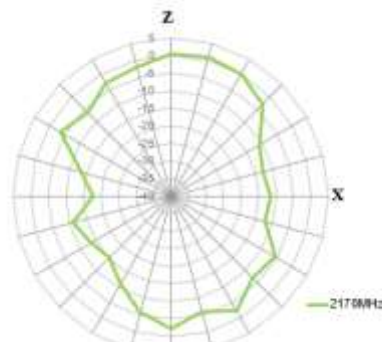

YZ Plane

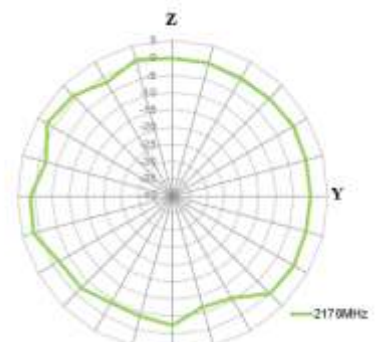

2300MHz

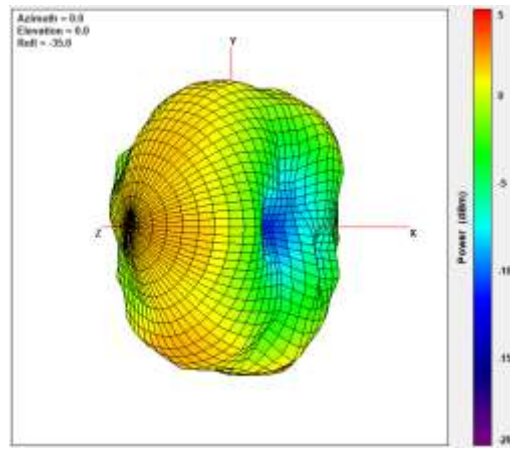

XY Plane

XZ Plane

YZ Plane

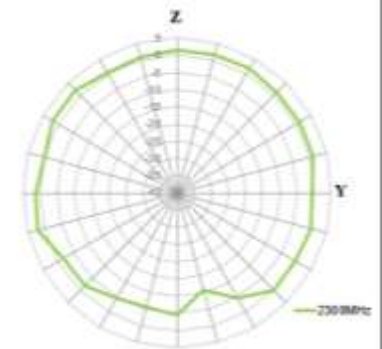
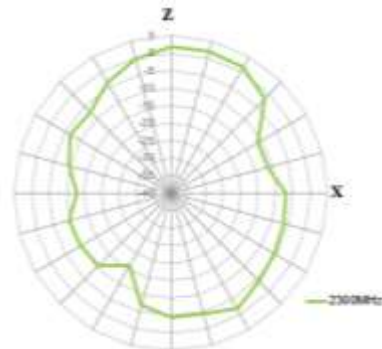
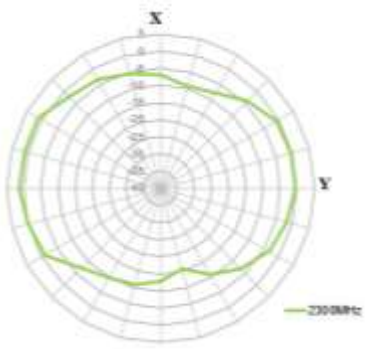

2690MHz

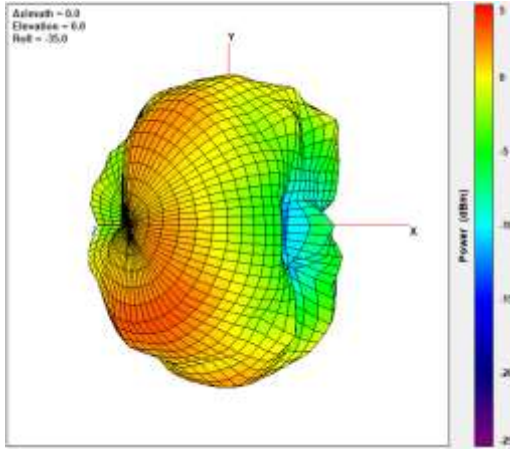

XY Plane

XZ Plane

YZ Plane

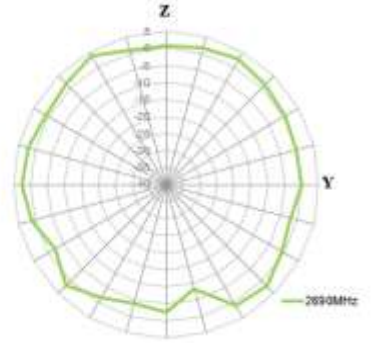
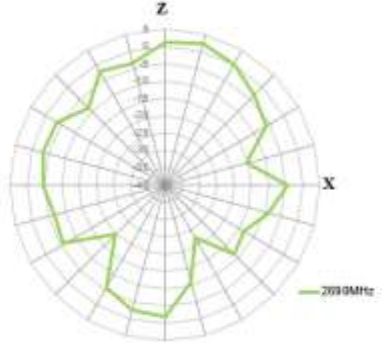
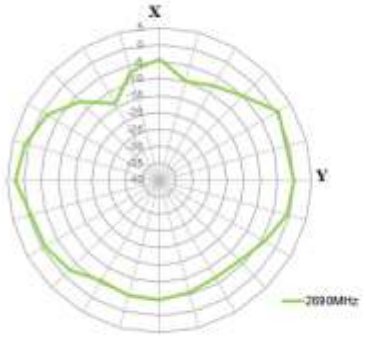

3400MHz

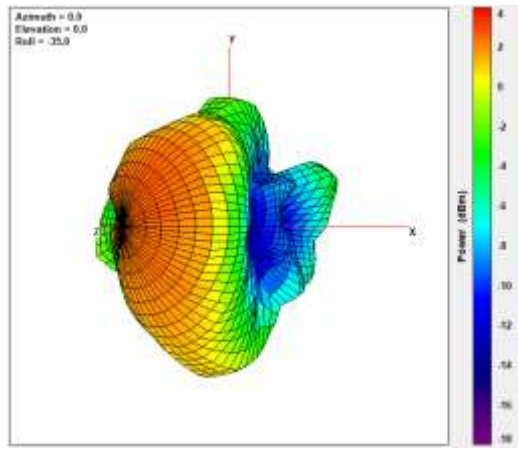

XY Plane

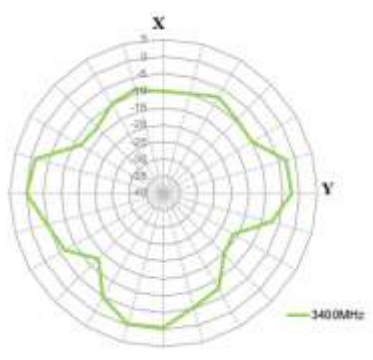

XZ Plane

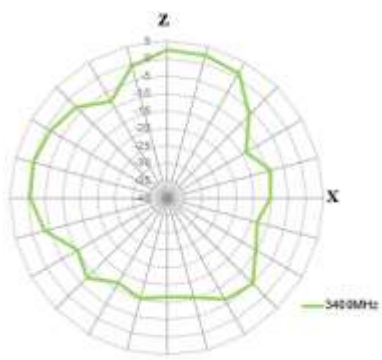

YZ Plane

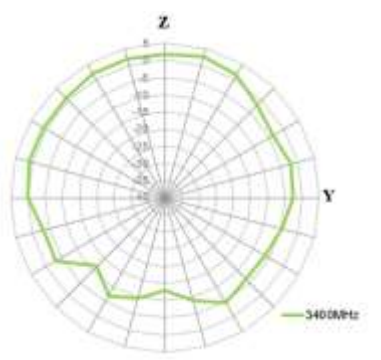

3800MHz

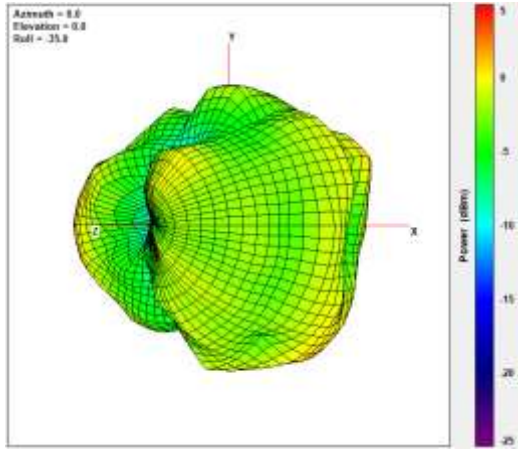

XY Plane

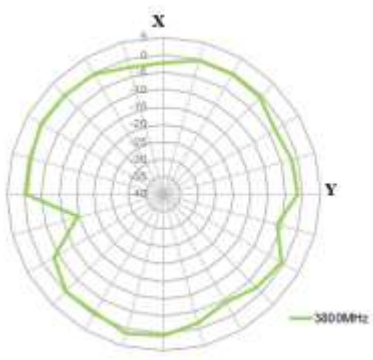

XZ Plane

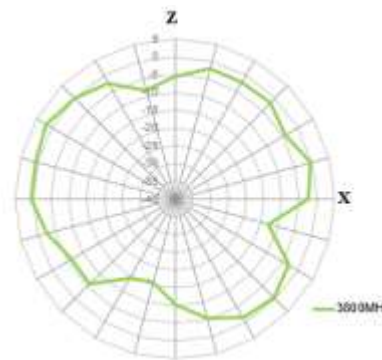

YZ Plane

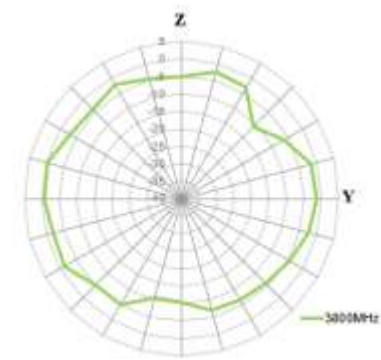

5550MHz

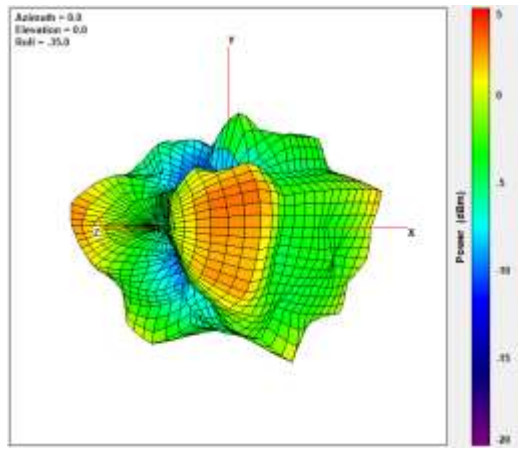

XY Plane

XZ Plane

YZ Plane

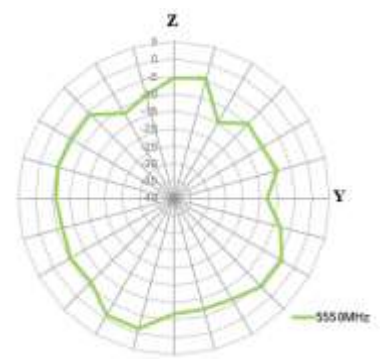
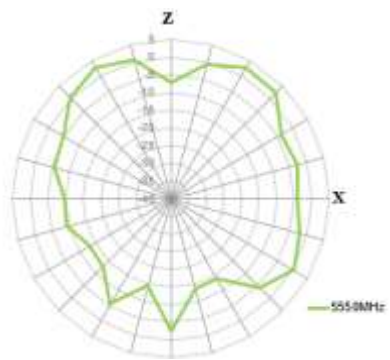
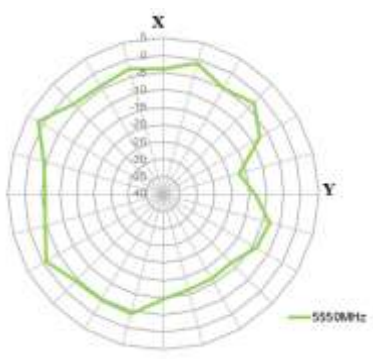

4. 650MHz _MIMO2_2mm ABS - 2D & 3D Radiation Patterns

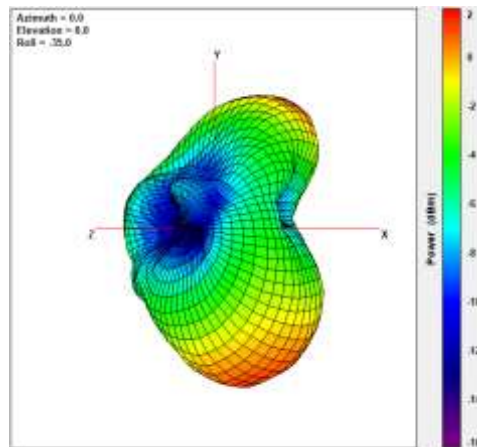

XY Plane

XZ Plane

YZ Plane

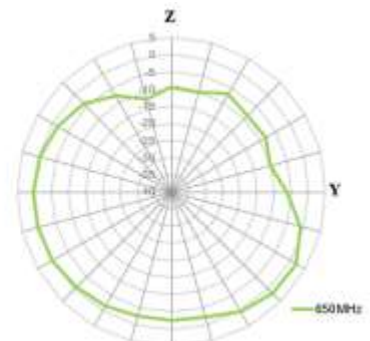
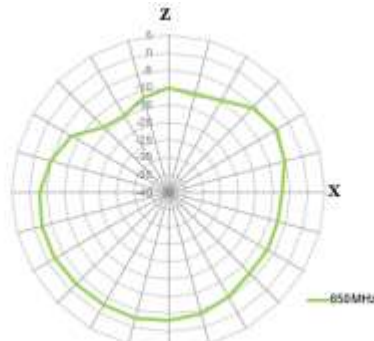
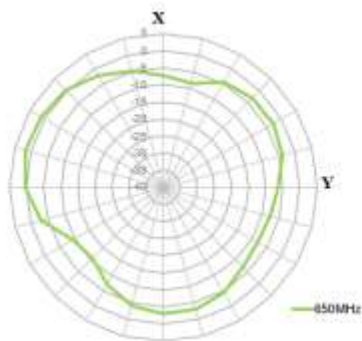

750MHz

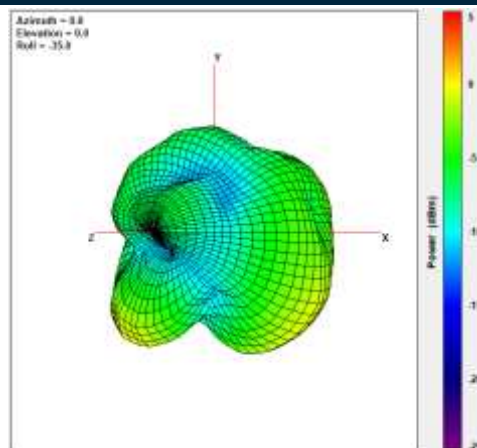

XY Plane

XZ Plane

YZ Plane

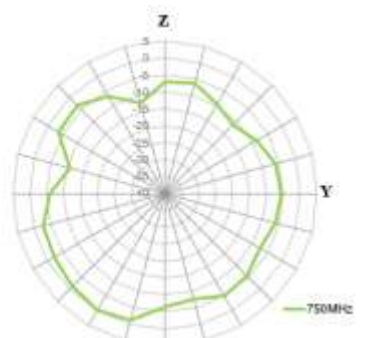
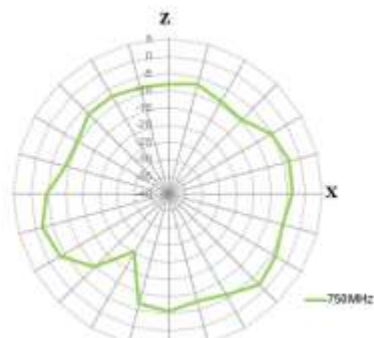
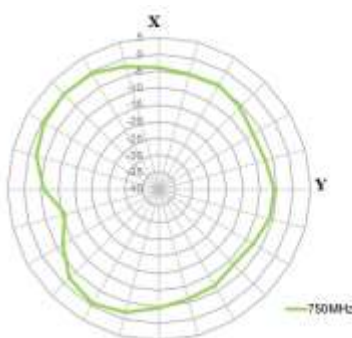

825MHz

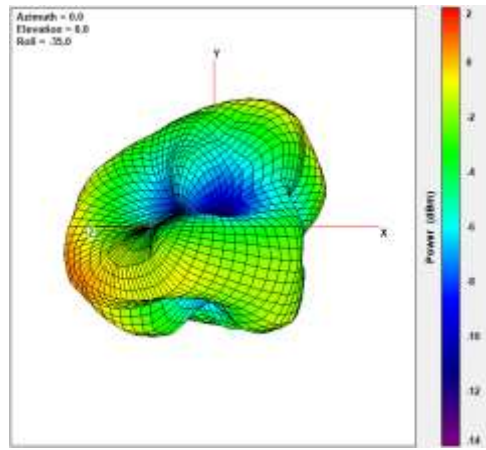

XY Plane

XZ Plane

YZ Plane

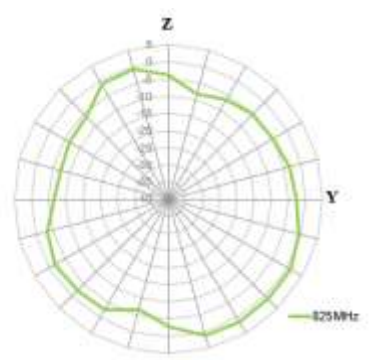
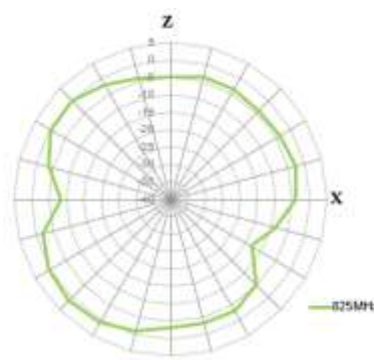
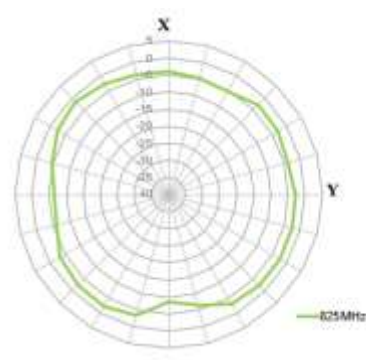

960MHz

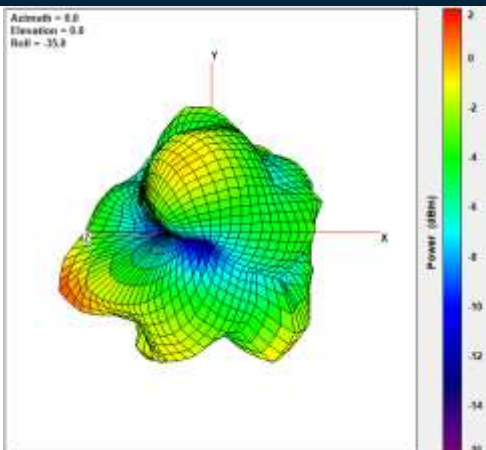

XY Plane

XZ Plane

YZ Plane

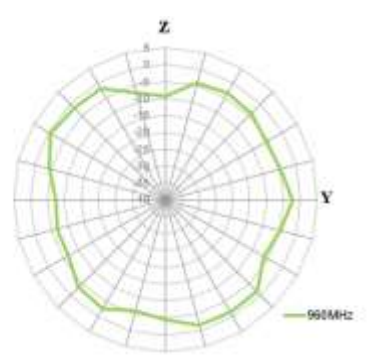
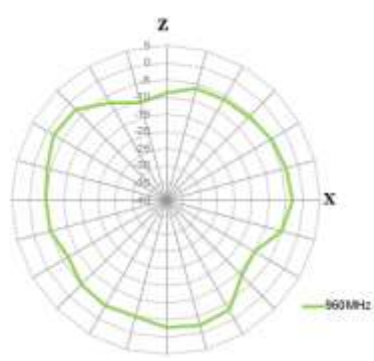
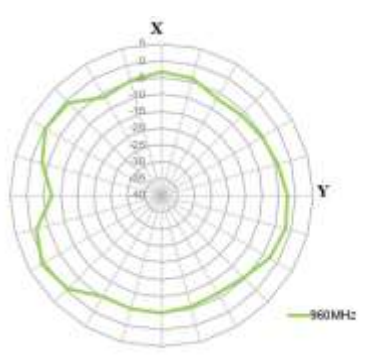

1710MHz

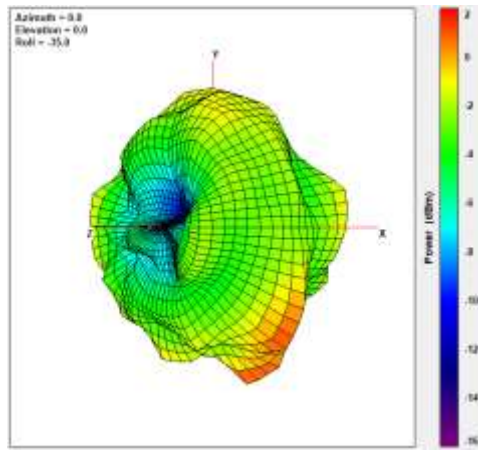

XY Plane

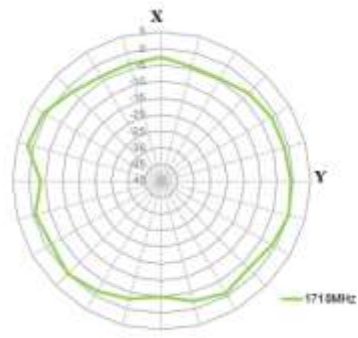

XZ Plane

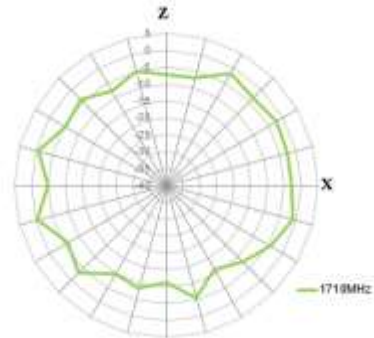

YZ Plane

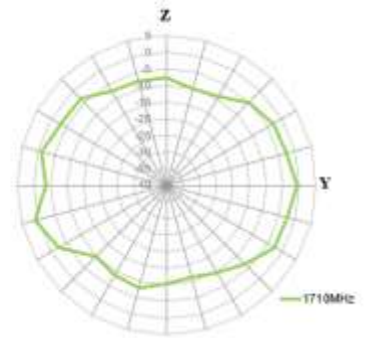

1880MHz

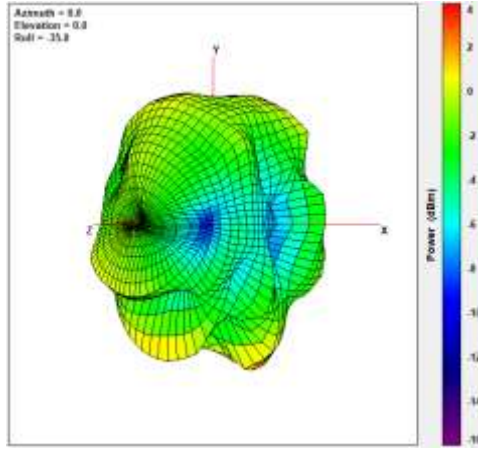

XY Plane

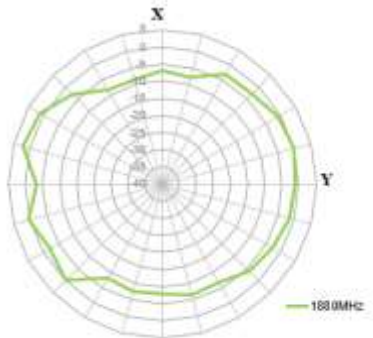

XZ Plane

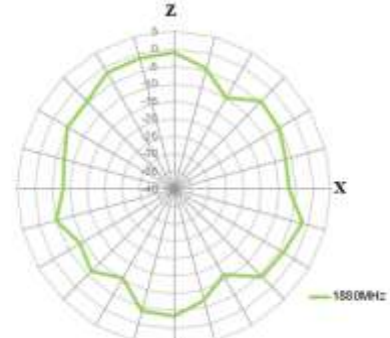

YZ Plane

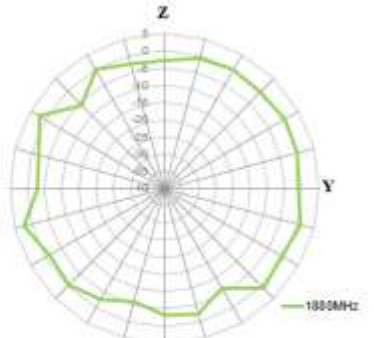

1990MHz

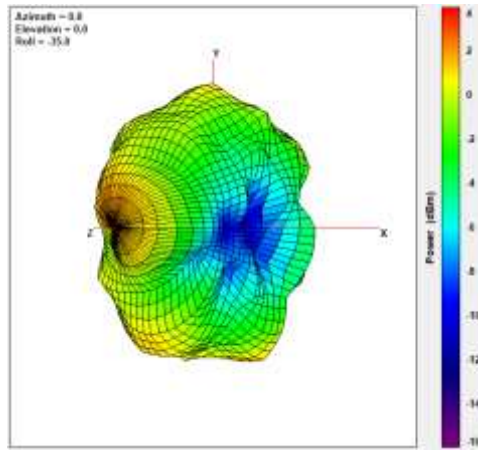

XY Plane

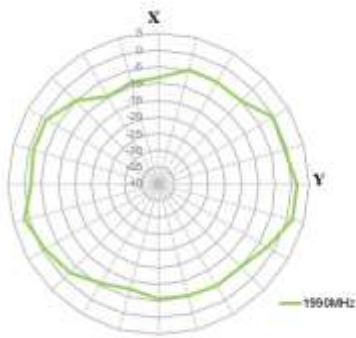

XZ Plane

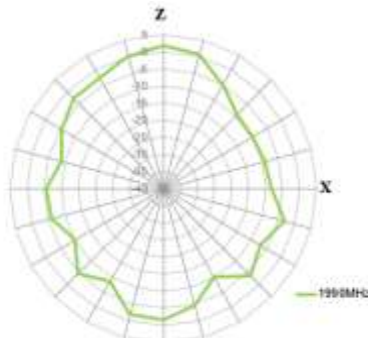

YZ Plane

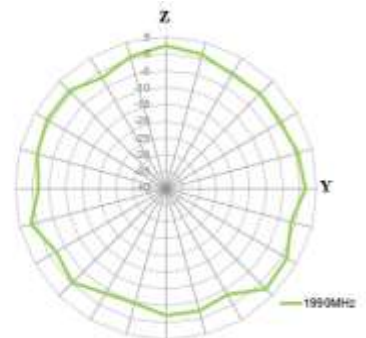

2170MHz

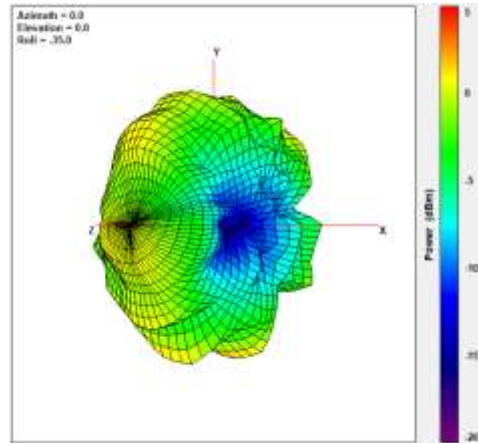

XY Plane

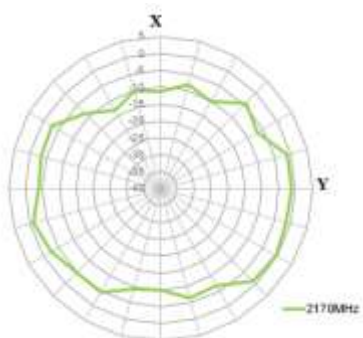

XZ Plane

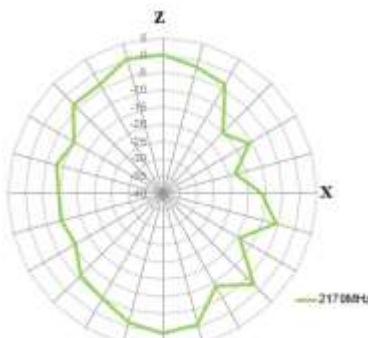

YZ Plane

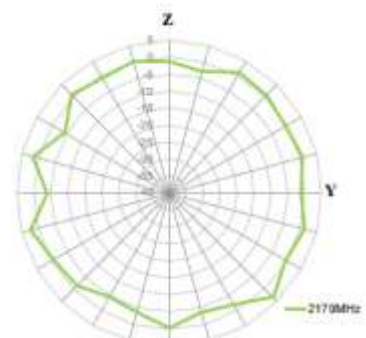

2300MHz

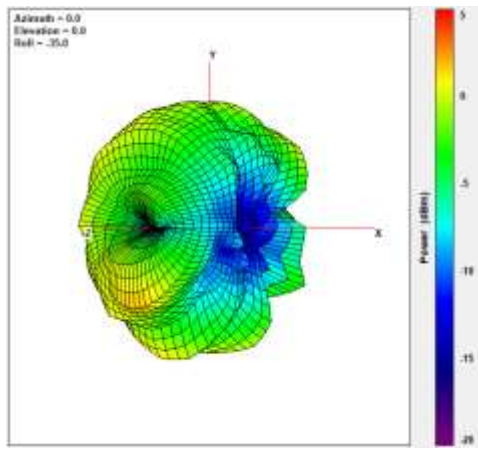

XY Plane

XZ Plane

YZ Plane

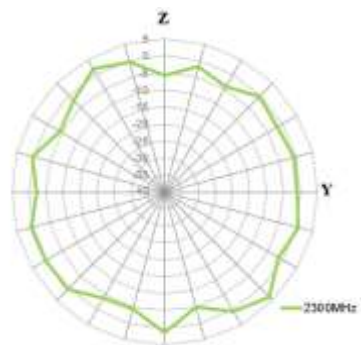
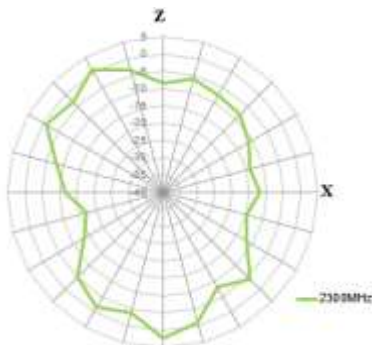

2690MHz

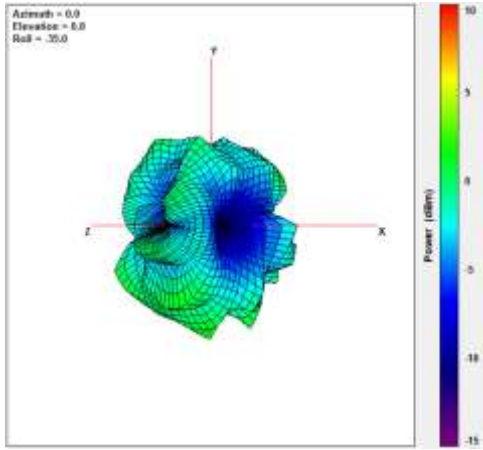

XY Plane

XZ Plane

YZ Plane

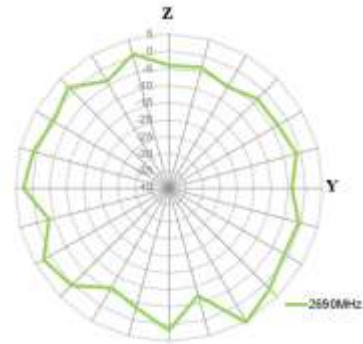
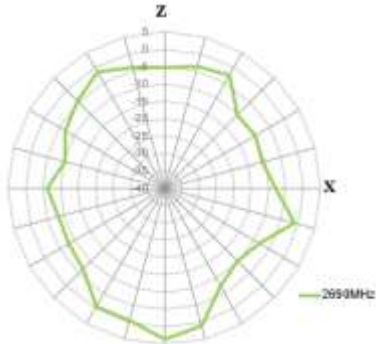
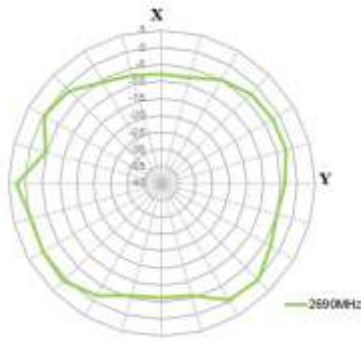

3400MHz

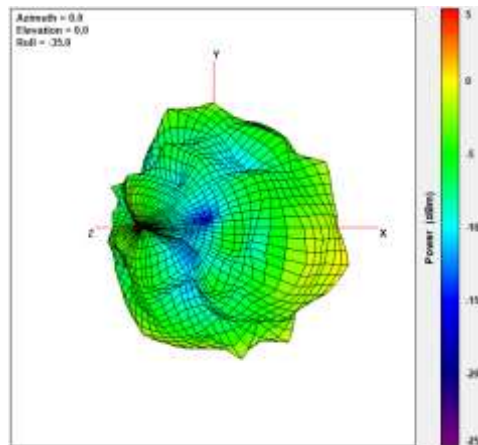

XY Plane

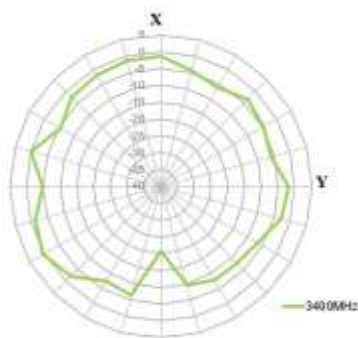

XZ Plane

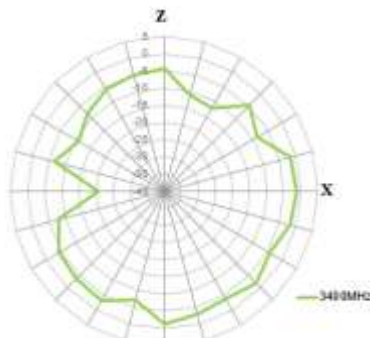

YZ Plane

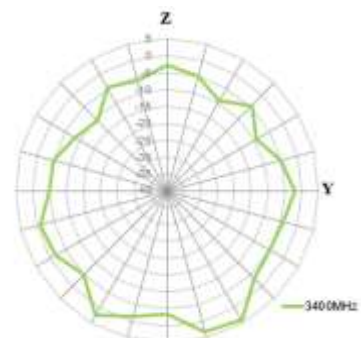

3800MHz

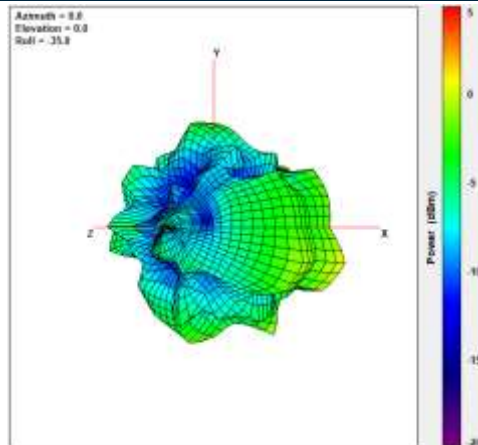

XY Plane

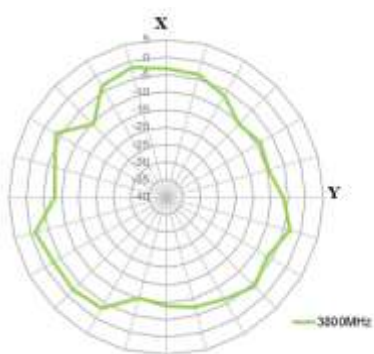

XZ Plane

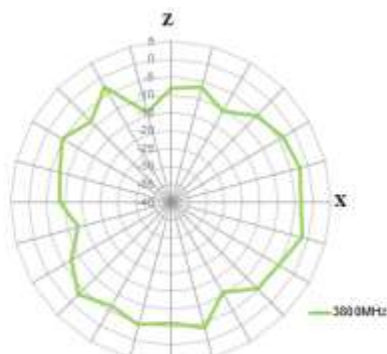

YZ Plane

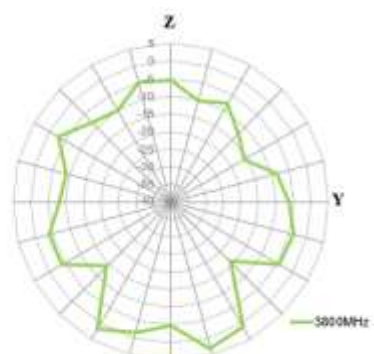

5550MHz

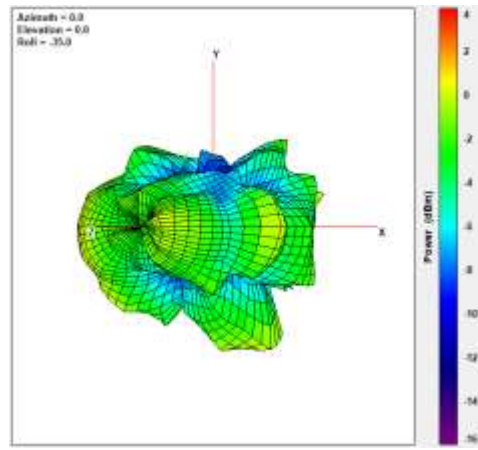

XY Plane

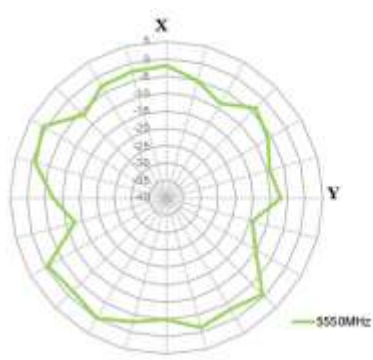

XZ Plane

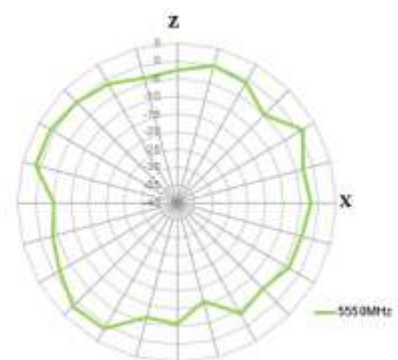

YZ Plane

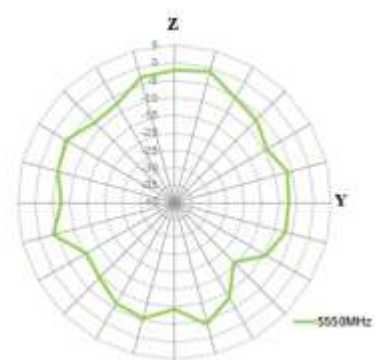

4.6 Test Setup – Glass Base

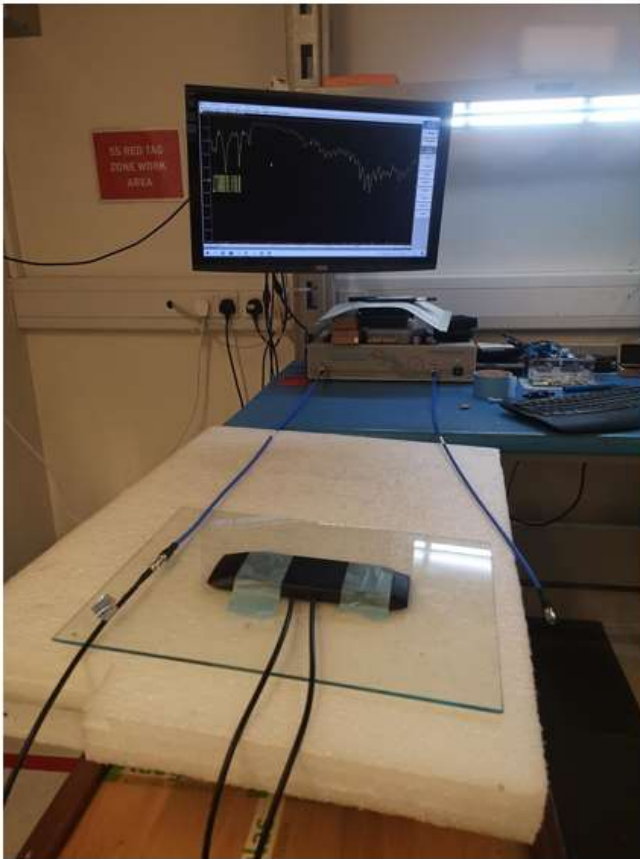

VNA Setup

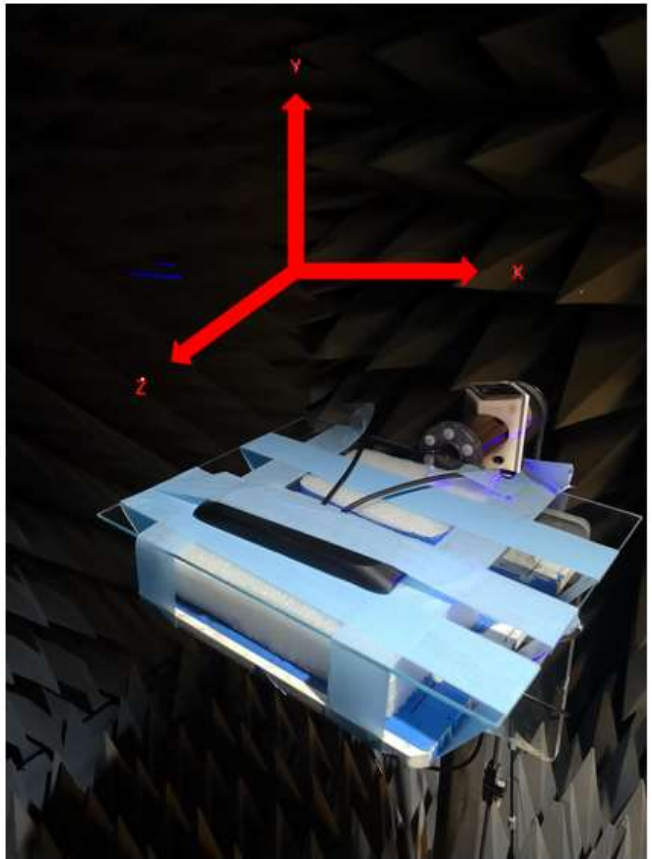

Chamber Setup

4.7 650MHz_MIMO1_Glass Base - 2D & 3D Radiation Patterns

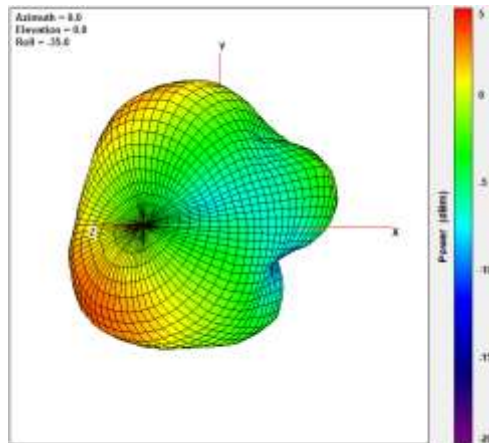

XY Plane

XZ Plane

YZ Plane

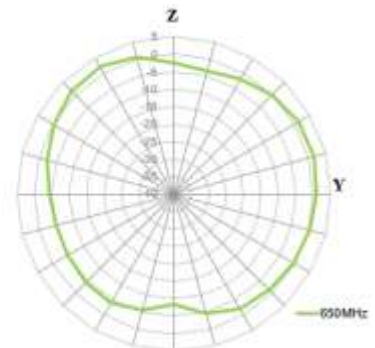
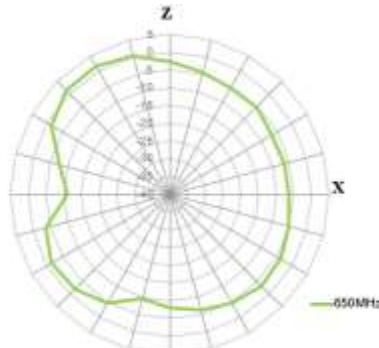
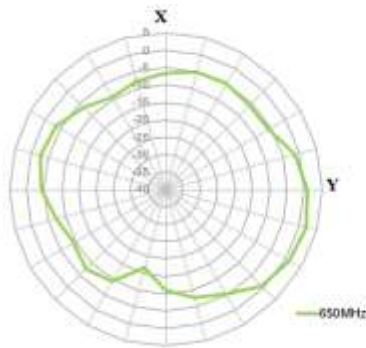

750MHz

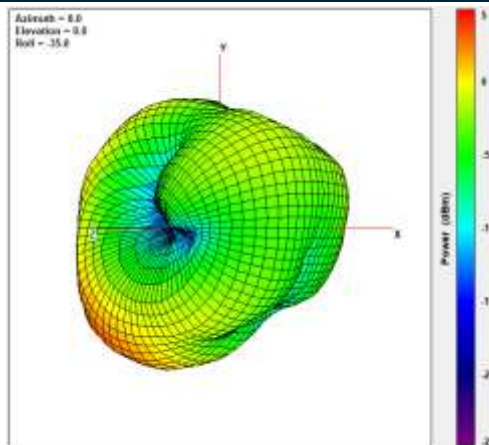

XY Plane

XZ Plane

YZ Plane

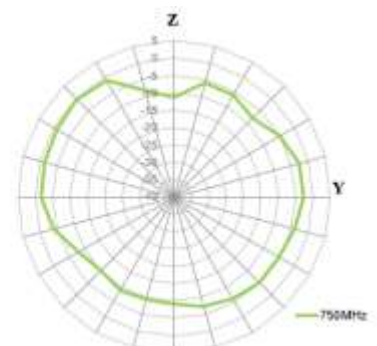
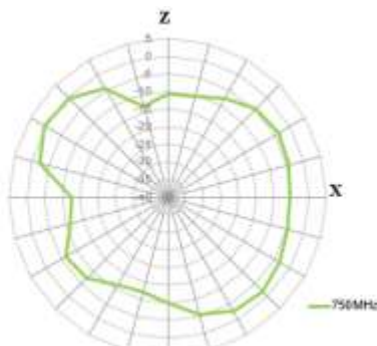
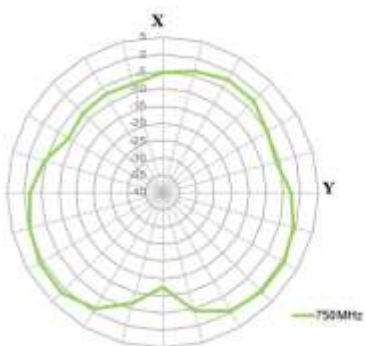

825MHz

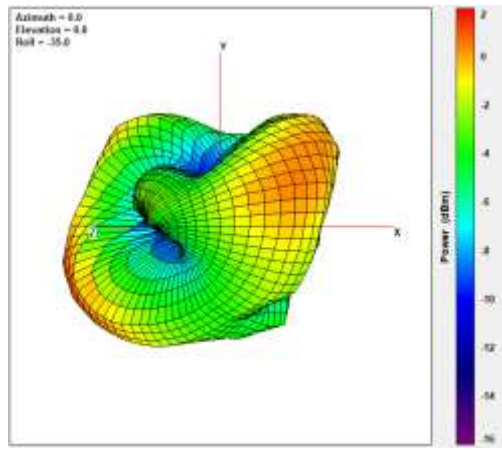

XY Plane

XZ Plane

YZ Plane

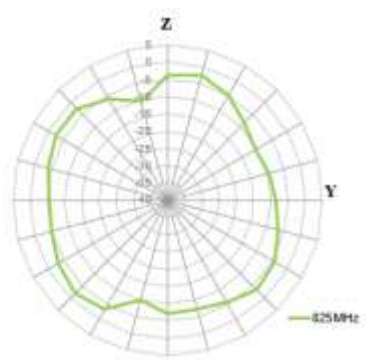
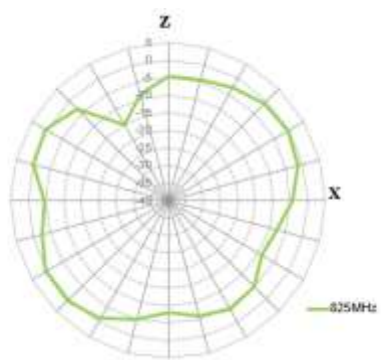
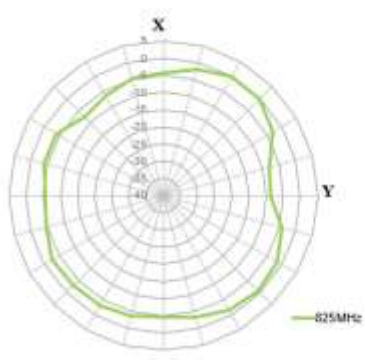

960MHz

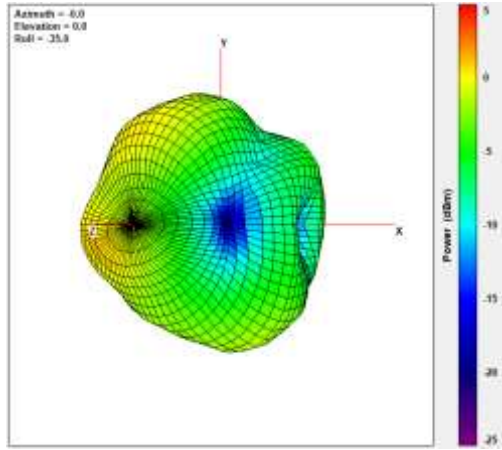

XY Plane

XZ Plane

YZ Plane

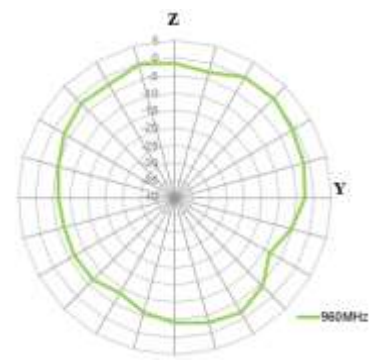
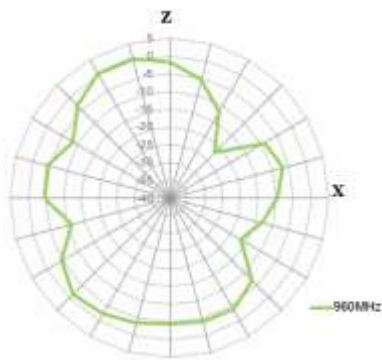
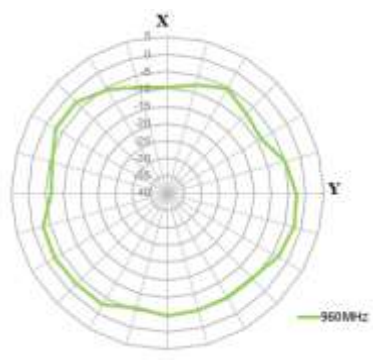

1710MHz

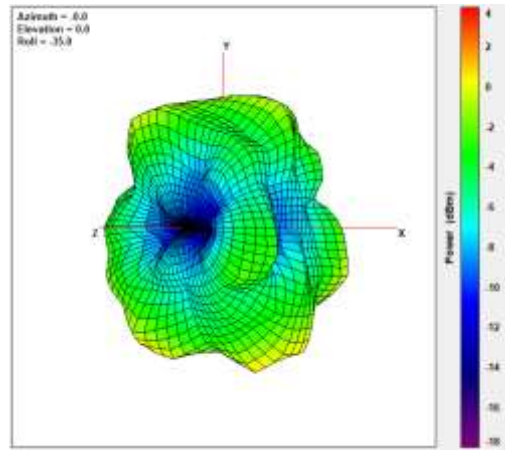

XY Plane

XZ Plane

YZ Plane

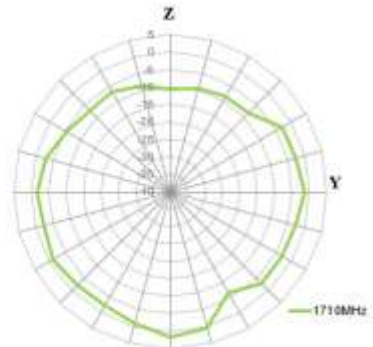
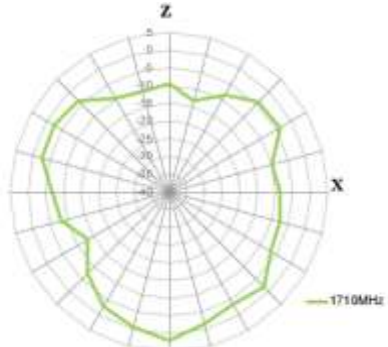
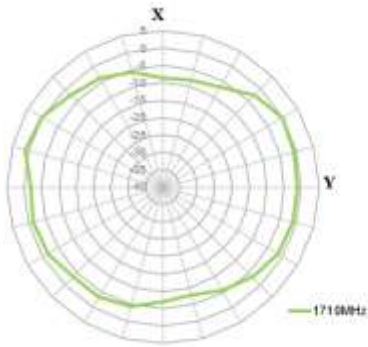

1880MHz

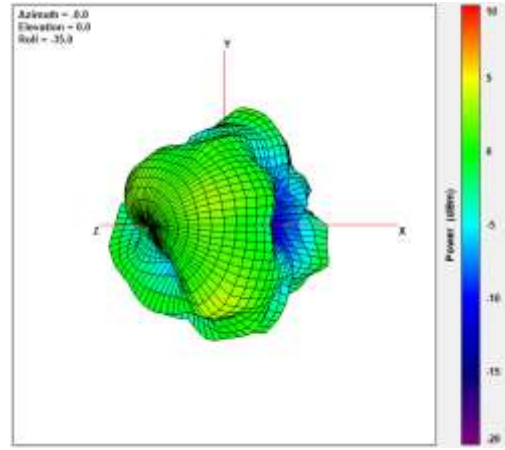

XY Plane

XZ Plane

YZ Plane

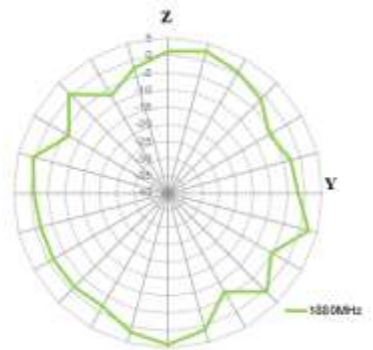
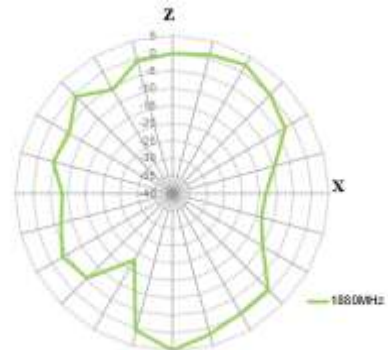
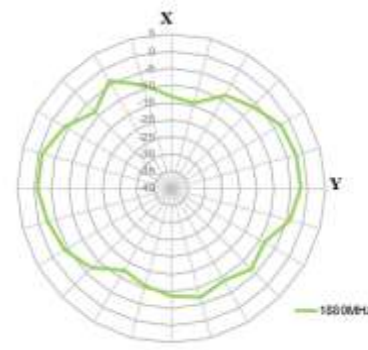

1990MHz

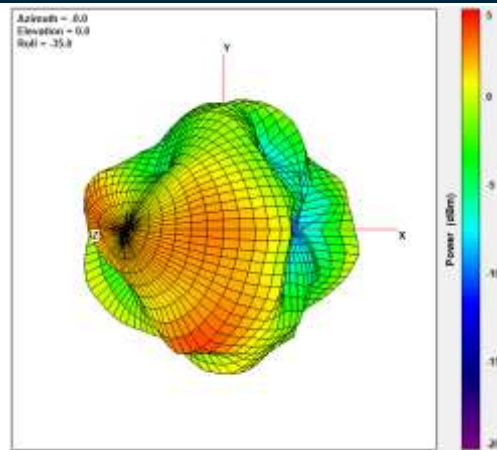

XY Plane

XZ Plane

YZ Plane

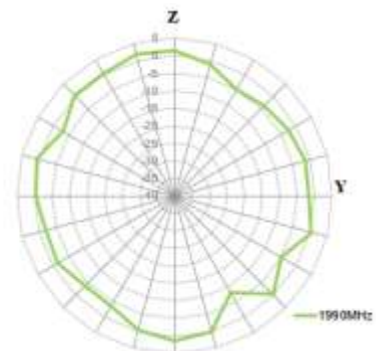
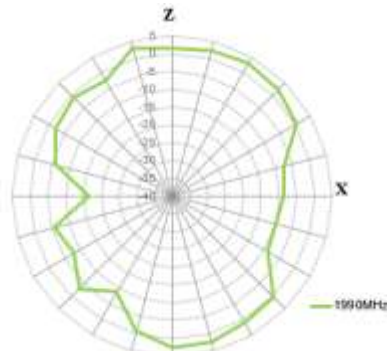
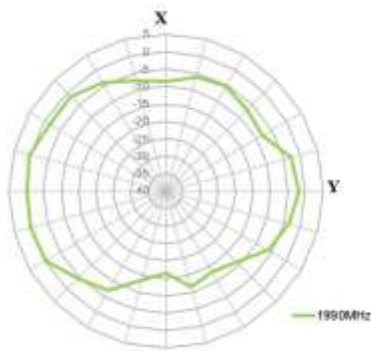

2170MHz

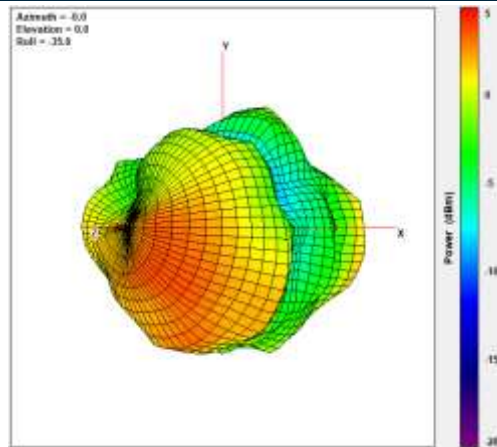

XY Plane

XZ Plane

YZ Plane

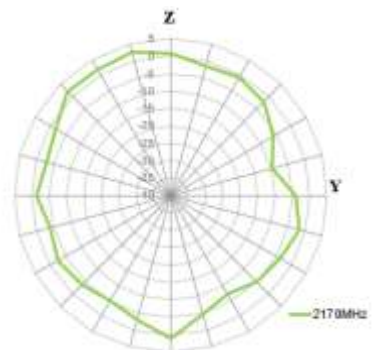
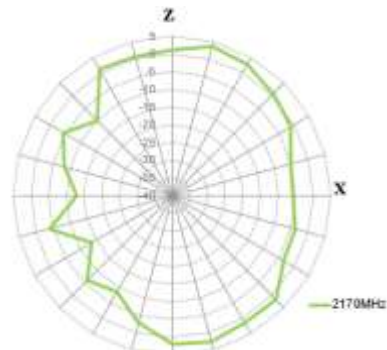
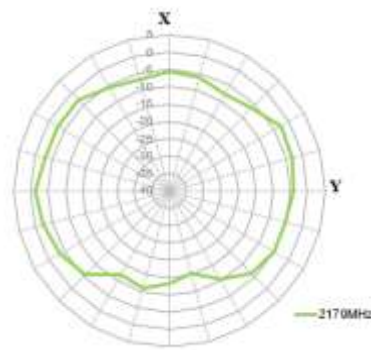

2300MHz

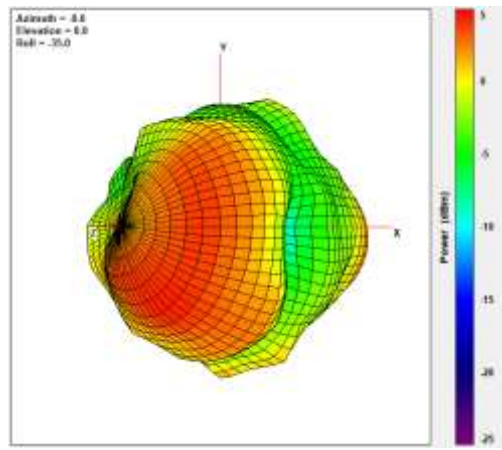

XY Plane

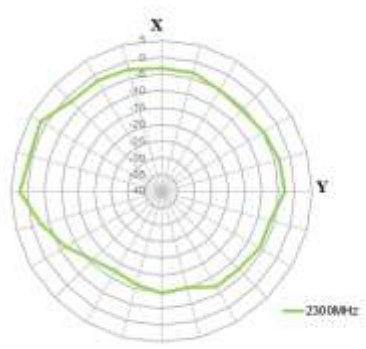

XZ Plane

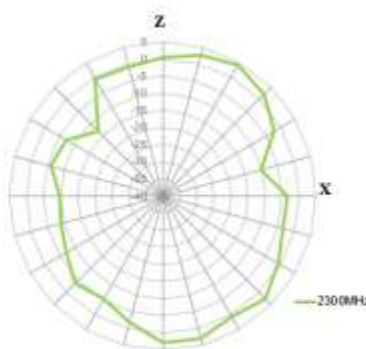

YZ Plane

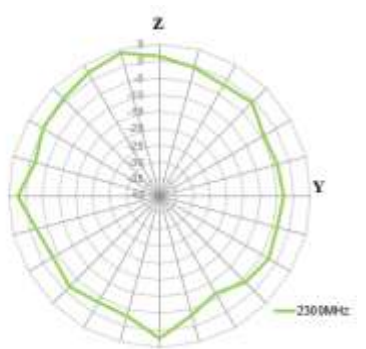

2690MHz

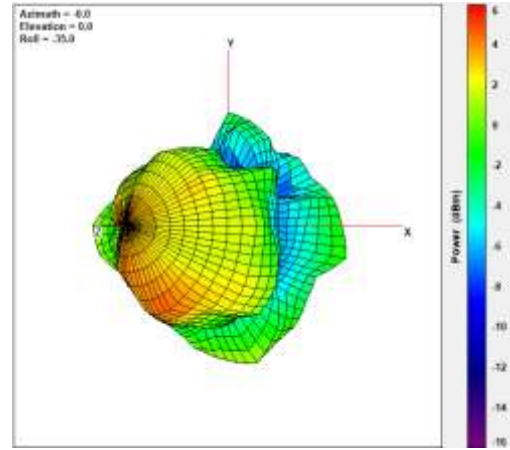

XY Plane

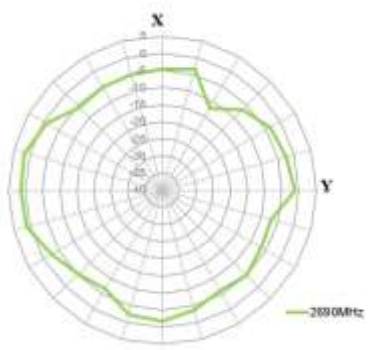

XZ Plane

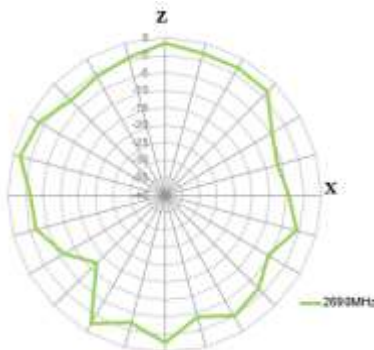

YZ Plane

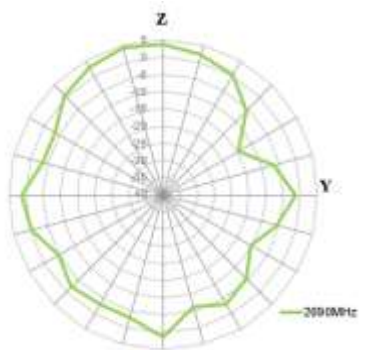

3400MHz

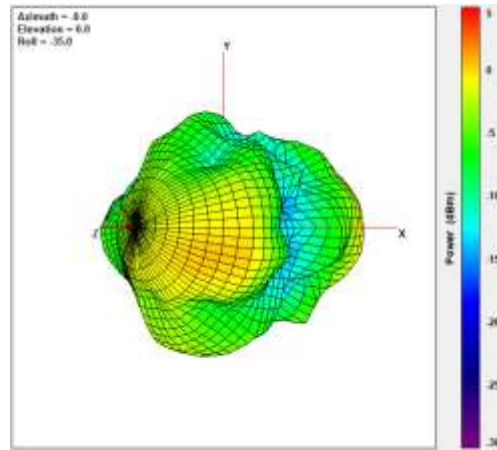

XY Plane

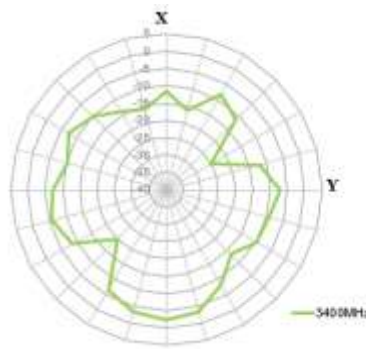

XZ Plane

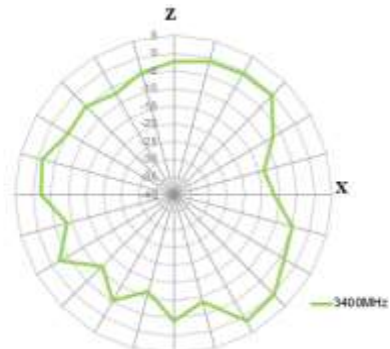

YZ Plane

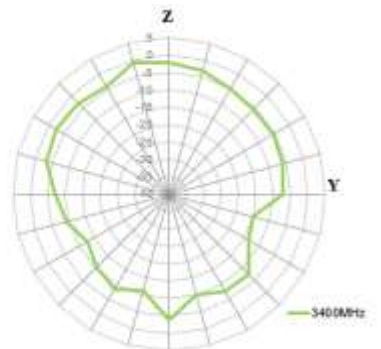

3800MHz

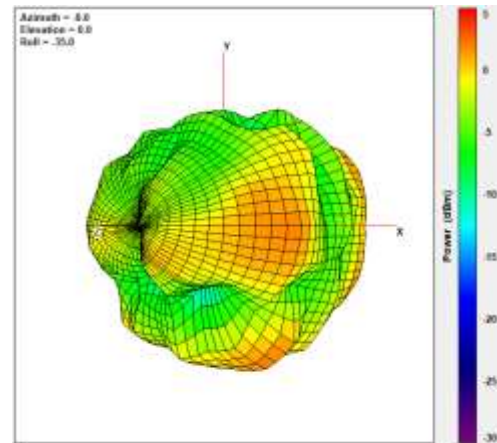

XY Plane

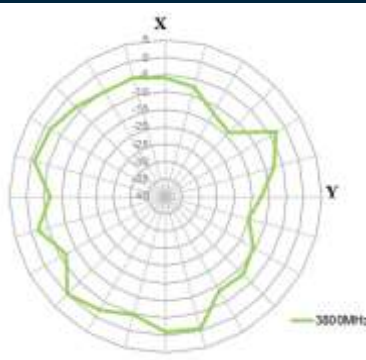

XZ Plane

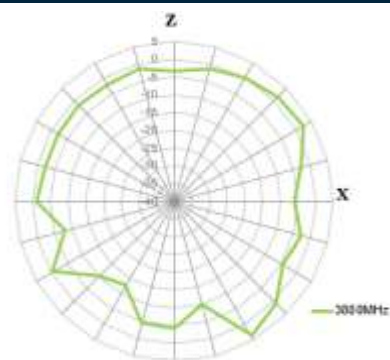

YZ Plane

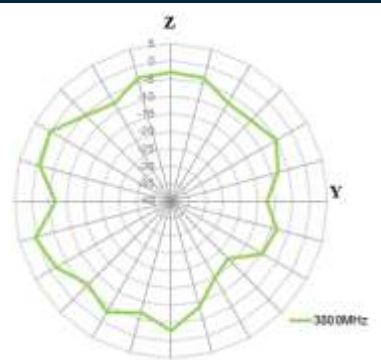

5550MHz

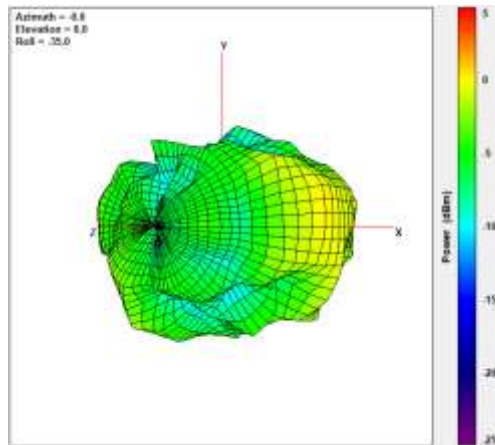

XY Plane

XZ Plane

YZ Plane

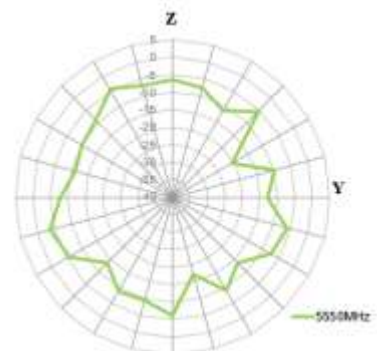
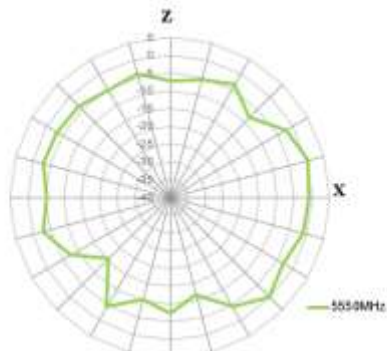
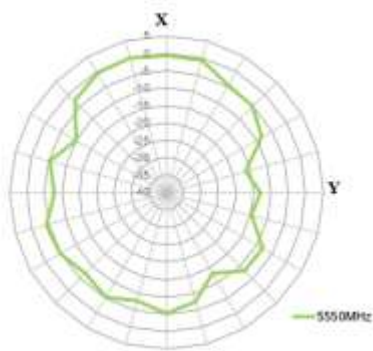

4.8 650MHz_MIMO2_Glass Base - 2D & 3D Radiation Patterns

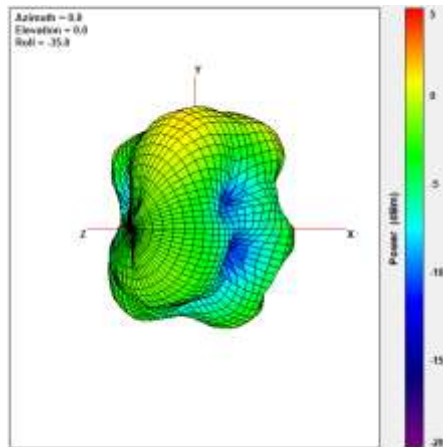

XY Plane

XZ Plane

YZ Plane

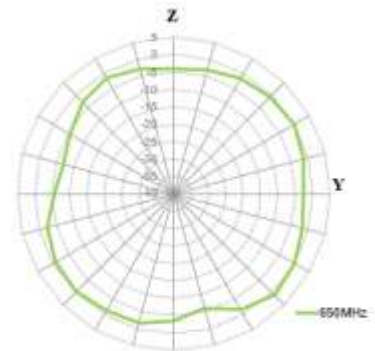
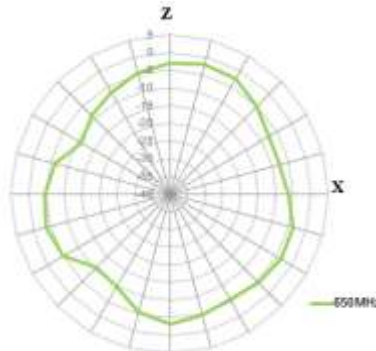
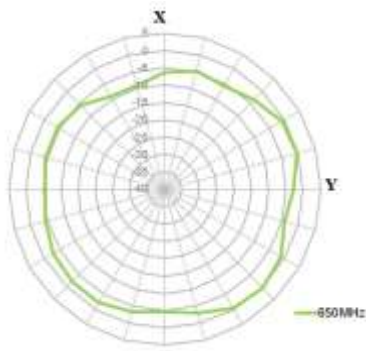

750MHz

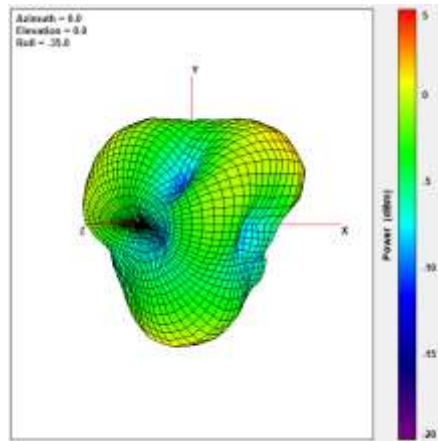

XY Plane

XZ Plane

YZ Plane

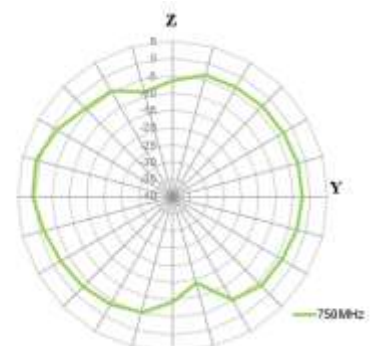
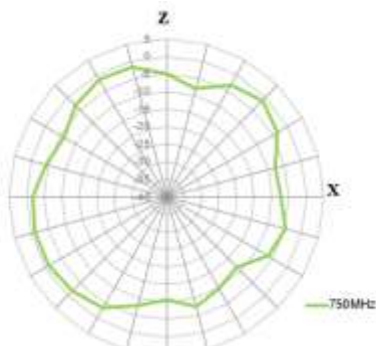
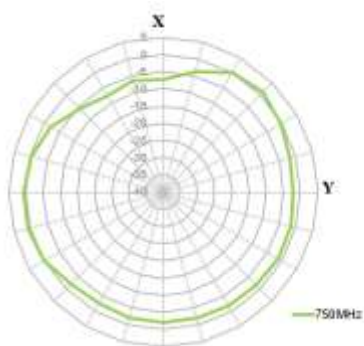

825MHz

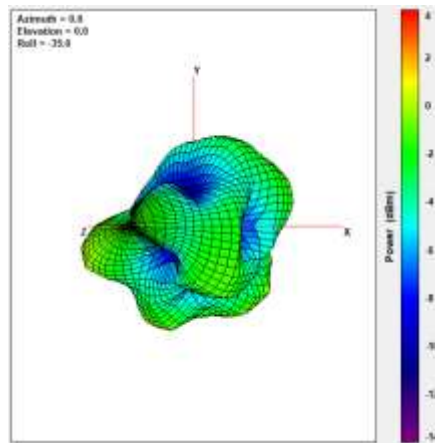

XY Plane

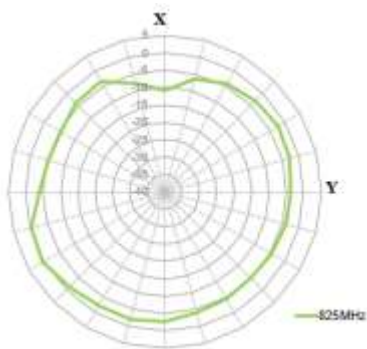

XZ Plane

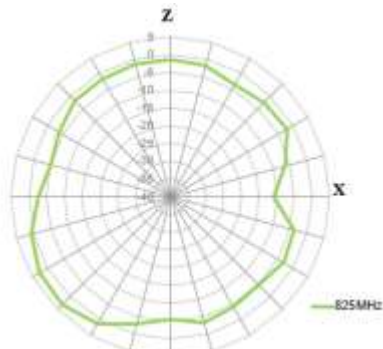

YZ Plane

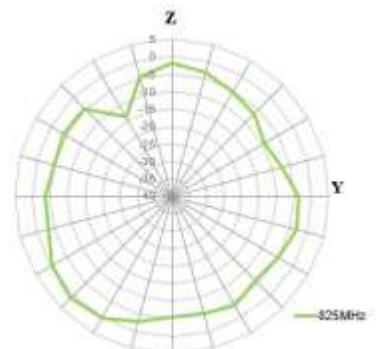

960MHz

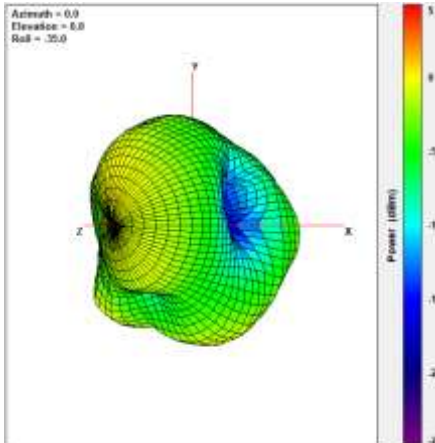

XY Plane

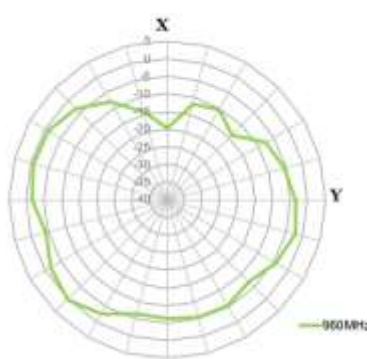

XZ Plane

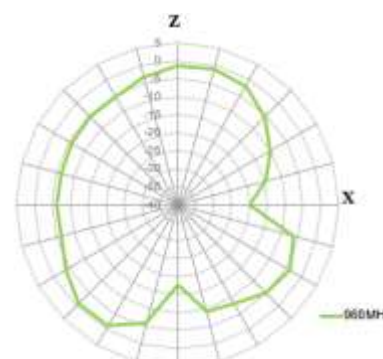

YZ Plane

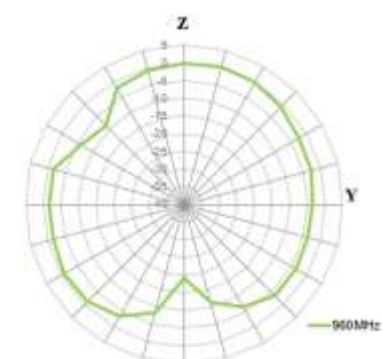

1710MHz

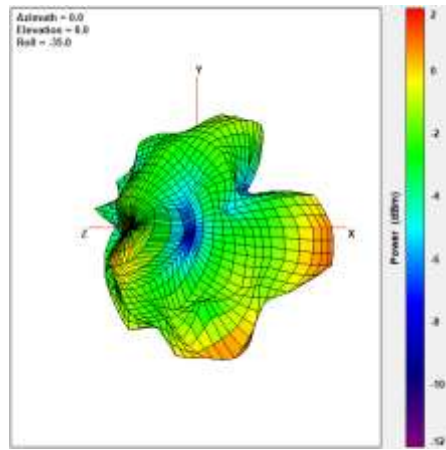

XY Plane

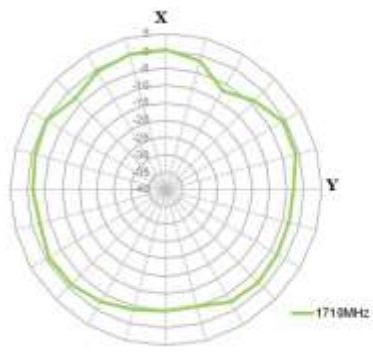

XZ Plane

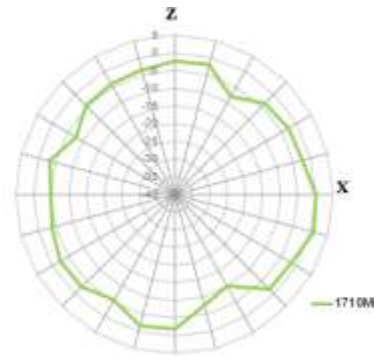

YZ Plane

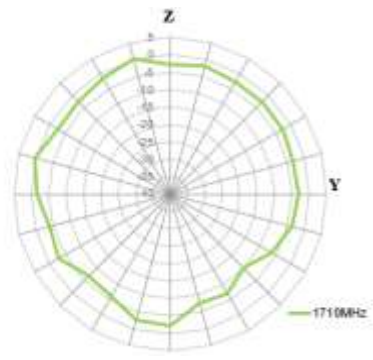

1880MHz

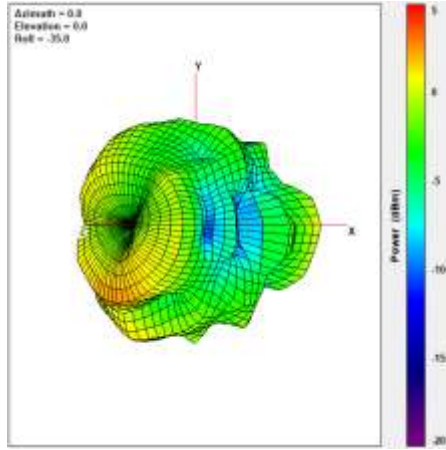

XY Plane

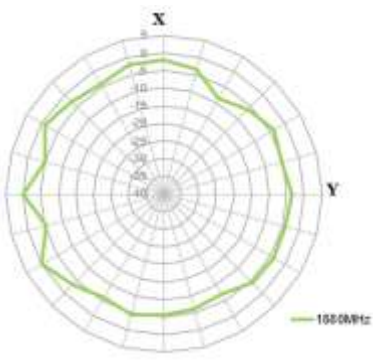

XZ Plane

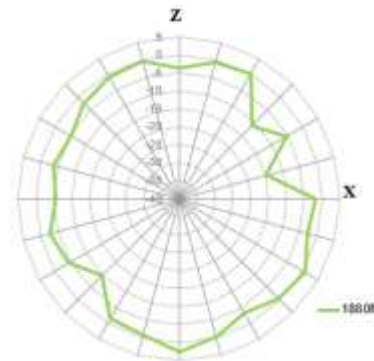

YZ Plane

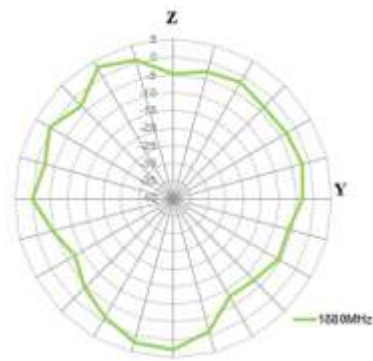

1990MHz

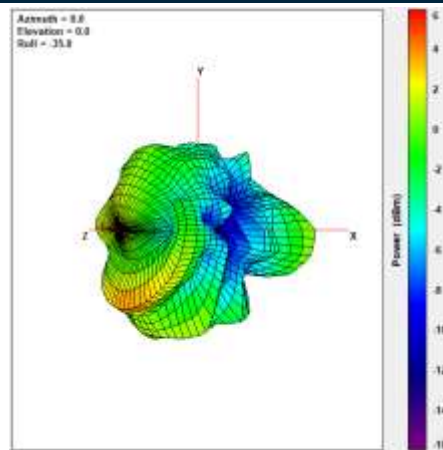

XY Plane

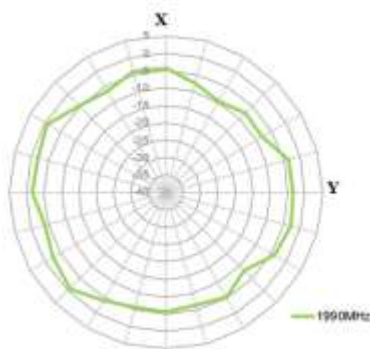

XZ Plane

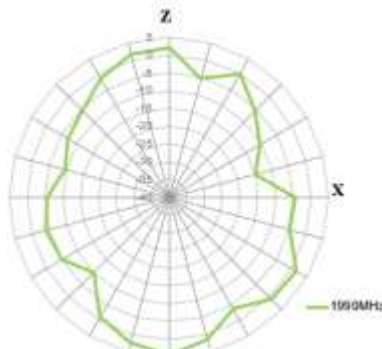

YZ Plane

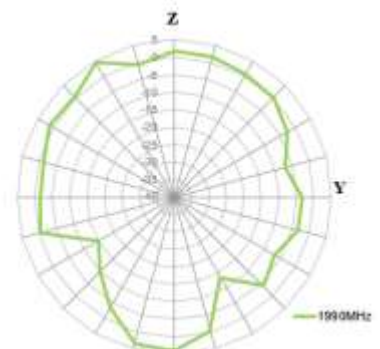

2170MHz

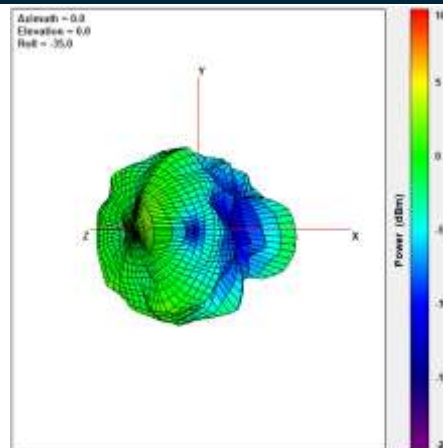

XY Plane

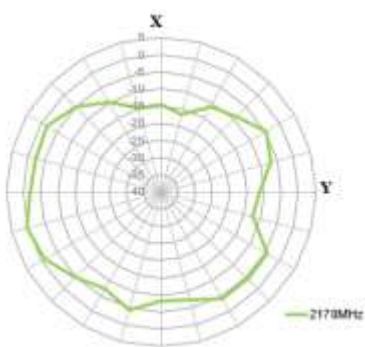

XZ Plane

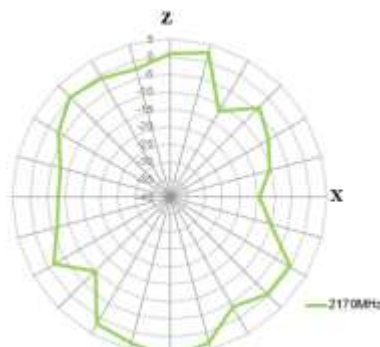

YZ Plane

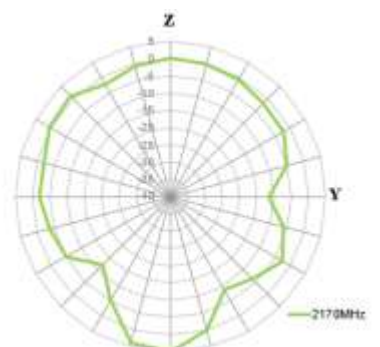

2300MHz

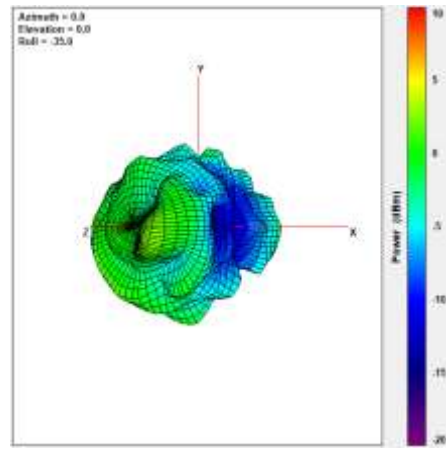

XY Plane

XZ Plane

YZ Plane

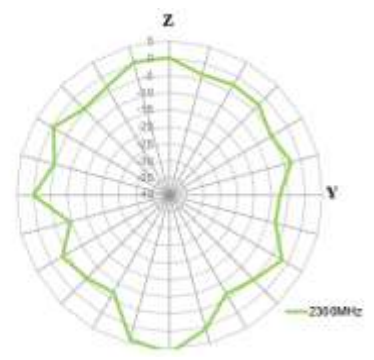
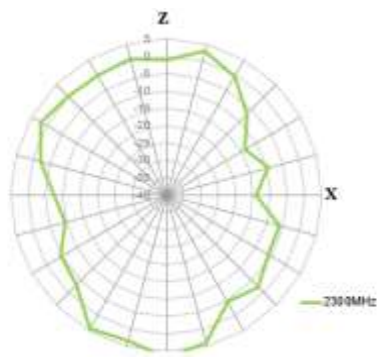
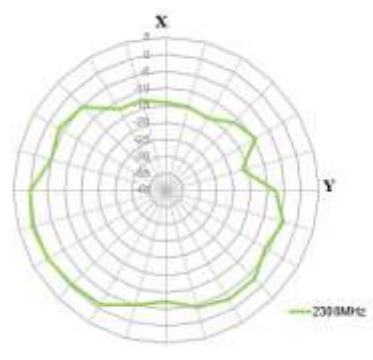

2690MHz

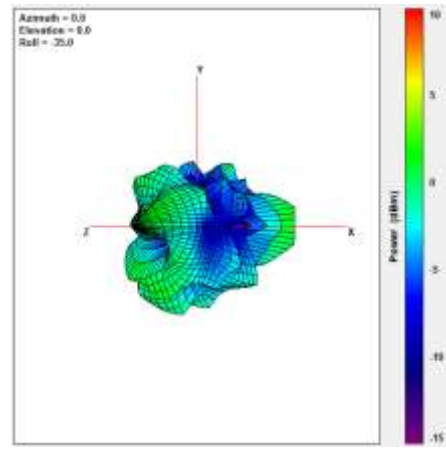

XY Plane

XZ Plane

YZ Plane

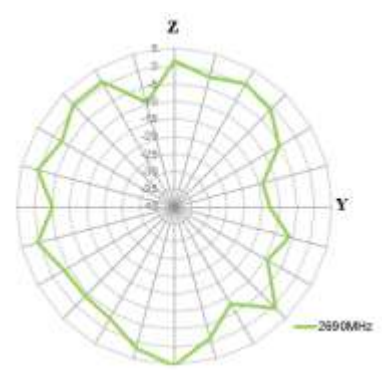
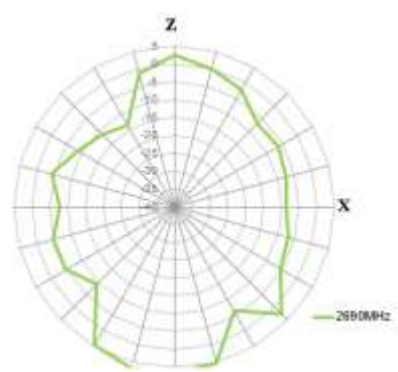
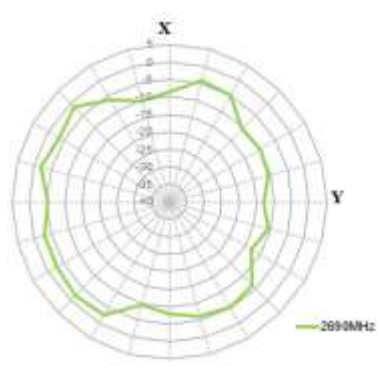

3400MHz

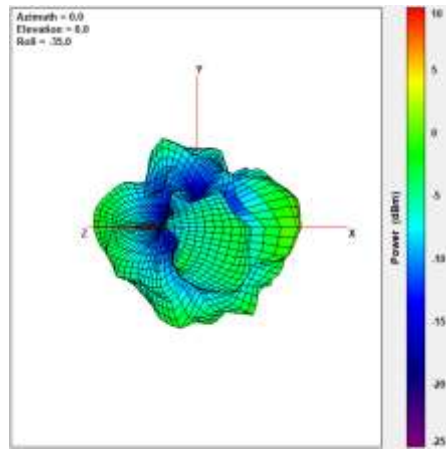

XY Plane

XZ Plane

YZ Plane

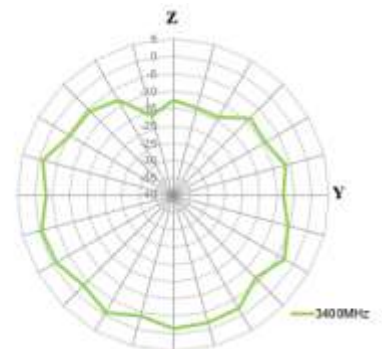
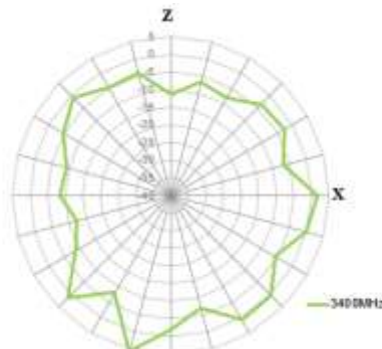
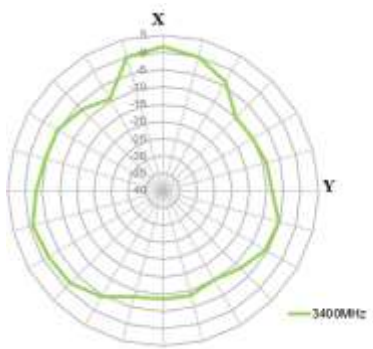

3800MHz

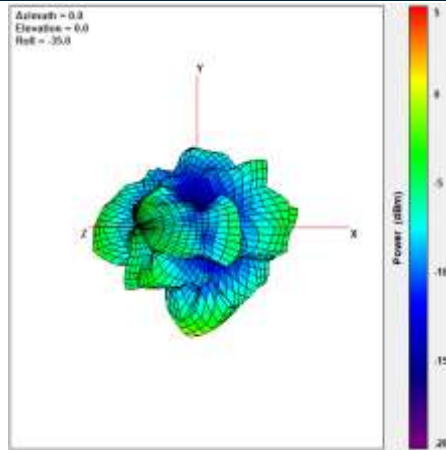

XY Plane

XZ Plane

YZ Plane

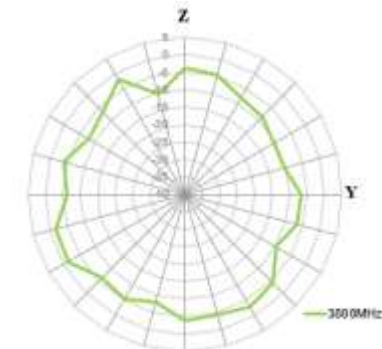
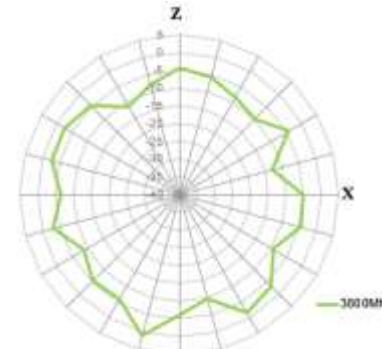
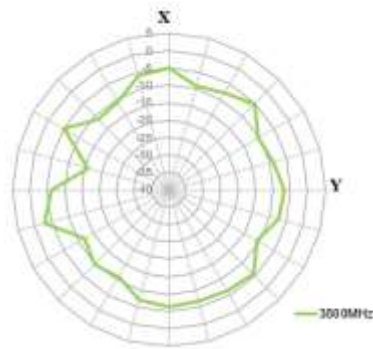

5550MHz

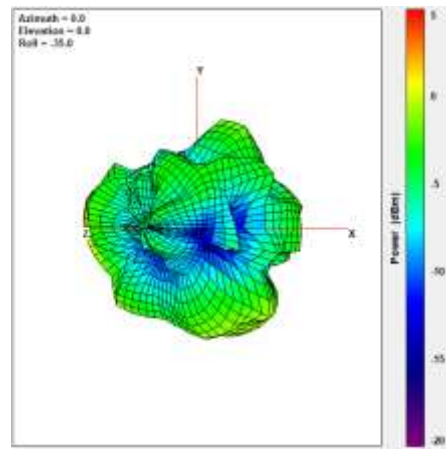

XY Plane

XZ Plane

YZ Plane

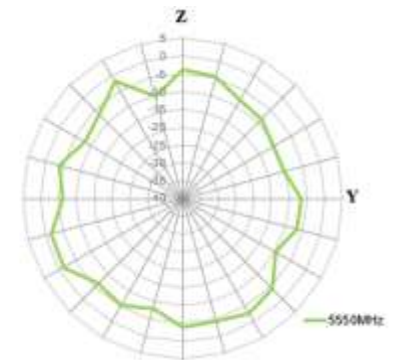
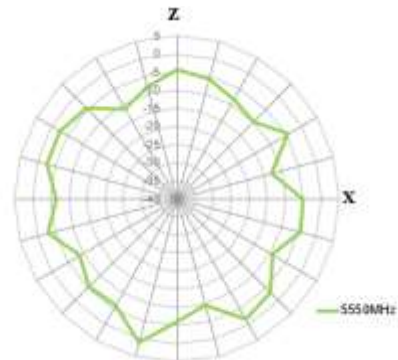
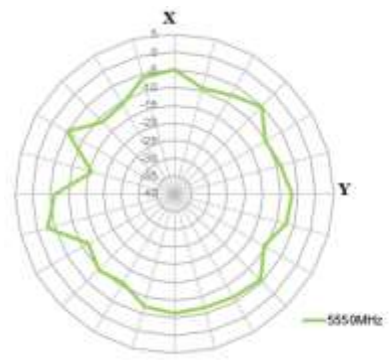

5. Mechanical Drawing (Units: mm)

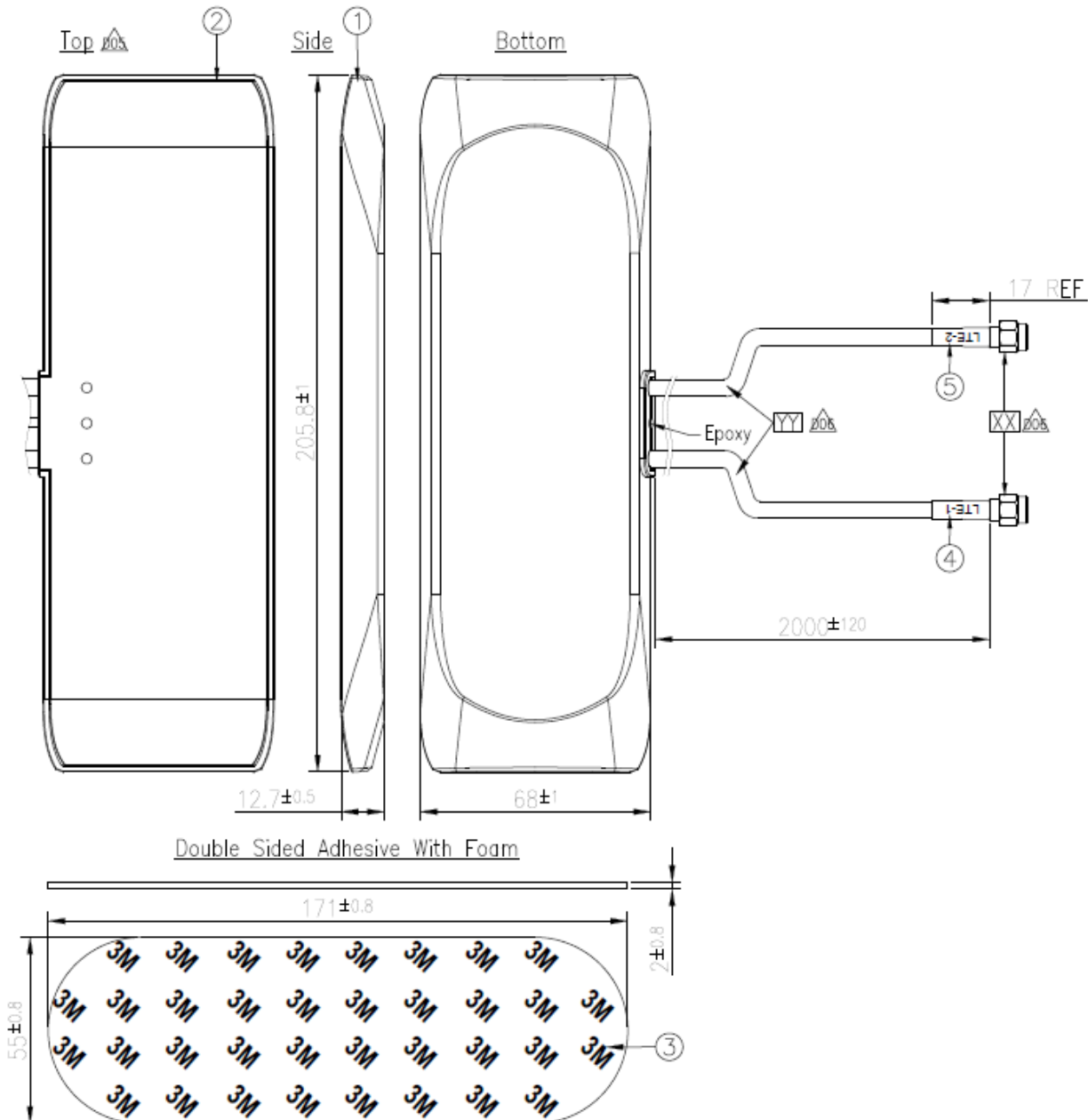

	Name	P/N	Material	Finish	QTY
1	Housing Top MA240	000113B000066A	ABS	Black	1
2	Housing Bottom MA240	000113B010066A	ABS	Black	1
3	Double Sided Adhesive(Black Foam)	001013G000039A	3M9448+CR4305	White Liner	1
4	Heat Shrink Tube (LTE-1)	001317C020000A	PE	Red Tube/White Text	1
5	Heat Shrink Tube (LTE-2)	001317C030000A	PE	Red Tube/White Text	1

	Name	P/N	Spec	Finish	QTY
XX	Connector Type	200216F020013A	SMA(M)ST	Au Plated	2
YY	Cable Type	306718E000000A	TGC200	Black	2

6. Packaging

1pcs MA241.BI.001 per PE Bag
 Bag Dimensions - 300 x 200mm

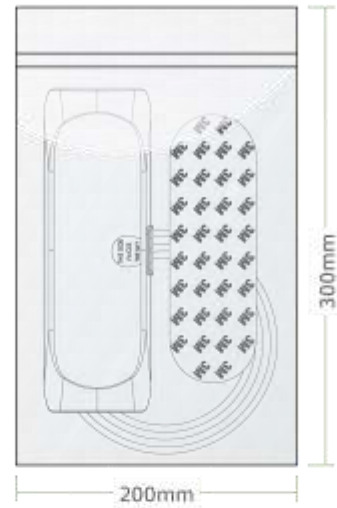

15 pcs MA241.BI.001 per carton
 Carton - 370 x 370 x 300mm

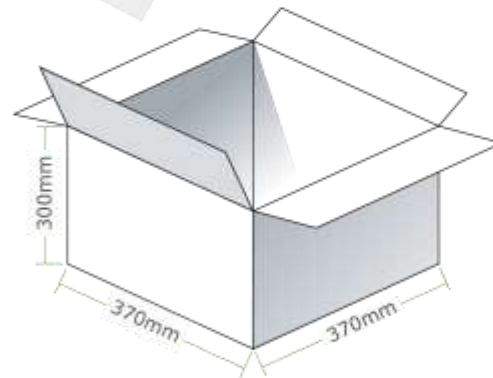

Changelog for the datasheet

SPE-18-8-085 – MA241.BI.001

Revision: F (Current Version)

Date:	2022-04-11
Changes:	Full datasheet update
Changes Made by:	Gary West

Previous Revisions

Revision: E

Date:	2019-01-11
Changes:	Heatshrink Drawing
Changes Made by:	Jack Conroy

Revision: D

Date:	2017-04-04
Changes:	Added LTE Band Table
Changes Made by:	Peter Monahan

Revision: C

Date:	2015-01-15
Changes:	Amended Dimensions
Changes Made by:	Aine Doyle

Revision: B

Date:	2015-01-15
Changes:	Amended Dimensions
Changes Made by:	Aine Doyle

Revision: A (Original First Release)

Date:	2014-08-28
Notes:	
Author:	Technical Writer



www.taoglas.com