

**Luminus LED™**  
**PT-120-TE**  
*Thermally Enhanced*  
*LED Projection Chipset*



### Table of Contents

Technology Overview ..... 2

Understanding Luminus Test Specifications..... 2

Ordering Information ..... 3

Blue DWL Bin Definition ..... 4

Flux /Power Bin Definition ..... 5

Optical & Electrical Characteristics ..... 6-7

Blue Flux Bin Ranges by Wavelength ..... 8

Characterization Curves ..... 9

Spectrum and Angular Intensity Distribution..... 10

Thermal Resistance ..... 11

Mechanical Dimensions ... 12-13

Shipping Tray Outline ..... 14

Packing and Shipping Specifications ..... 15

History of Changes ..... 16

### Features:

- Matched RGB Chipset with 12 mm<sup>2</sup> emitting area designed for projection applications
- 16:9 aspect ratio matched with micro-display and screen aspect ratio
- Ultra low thermal resistance package enables high performance applications [operation up to 36 A (3 A/mm<sup>2</sup>)]
- Wide color gamut: Red 623 nm, Red-Amber 613 nm, Green 525 nm, Blue 460 nm typical dominant wavelength
- Single emitting area per color allows for collection with single lens for simplified optics
- High precision LED placement on copper core PCB for easier thermal management and optical integration
- Environmentally friendly: RoHS and REACH compliant

### Applications

- Data front projectors and professional Rear-Projection Displays with 16:9 aspect ratio
- Optimized for Micro-Display diagonal sizes ranging from 0.65" to 0.95" with 16:9 aspect ratio
- Suitable for DLP™ (0.65" XGA, 0.95" 1080p), LCoS, HTPS and 3LCD microdisplays

## Technology Overview

Luminus Devices' Projection Technology (PT) is an innovative solid-state light source created to replace arc lamps in projection systems, enabling a new category of lamp-free projectors. Enabled by Luminus technology, our chipsets represent a major breakthrough in brightness that delivers all the benefits of solid state light sources in projections applications, including wide color gamut for vivid colors, exceeds NTSC, Environmentally friendly technology (Mercury-free), instant start and re-start with no more wait time, high reliability; no more lamp replacement, and electronic control of color points and light intensity on a frame by frame basis. Luminus products benefit from numerous innovations in the domain of packaging, thermal management and optical coupling that allow designers to achieve efficient light engine designs and deliver high screen brightness.

### Packaging Technology

Thermal management is critical in high power LED applications. With a thermal resistance from junction to case of  $0.4^{\circ}\text{C/W}$ , Luminus PT-120 LEDs can be driven at higher current densities while maintaining a low junction temperature, thereby resulting in brighter solutions and longer lifetimes.

### Reliability

For high power operation, Luminus LEDs™ are one of the most reliable light sources in the world today. Luminus LEDs have passed a rigorous suite of environmental and mechanical stress tests, including mechanical shock, vibration, temperature cycling and humidity, and have been fully qualified for use in extreme high power and high current applications. With very low failure rates and median lifetimes that typically exceed 60,000 hours, Luminus LEDs are ready for even the most demanding applications. (Please refer to Luminus' Reliability application note for more information.)

### Environmental Benefits

Luminus LEDs help reduce power consumption and the amount of hazardous waste entering the environment. All Luminus LED products manufactured by Luminus are RoHS and REACH compliant and free of hazardous materials, including lead and mercury.

## Understanding Luminus LED Test Specifications

Every Luminus LED is extensively tested at full current to ensure that it meets the high quality standards expected from Luminus' products.

### Testing of Luminus LEDs

Luminus core board products are typically measured in such a way that the characteristics reported agree with how the devices will actually perform when incorporated into a system. This measurement is accomplished by mounting the devices on a  $40^{\circ}\text{C}$  heat sink and allowing the device to reach thermal equilibrium while fully powered. Only after the device reaches equilibrium are the measurements taken. This method of measurement ensures that Luminus LEDs perform in the field just as they are specified.

Expected flux values in real world operation can be extrapolated based on the information contained within this product data sheet.

### Ordering Information

Ordering Part Number <sup>1</sup>	Color	Min Flux Bin <sup>2</sup>	Description
PT-120-R-L11-MPD <sup>3</sup>	Red	5C	Red LED, consisting of a 12 mm <sup>2</sup> LED chip , thermistor and connector mounted on a copper-core PCB.
PT-120-R-L11-MPE <sup>3</sup>		5D	
PT-120-R-L11-MPF <sup>3</sup>		5E	
PT-120-RA-L11-MPE <sup>3</sup>	Red Amber	5D	Red-Amber LED, consisting of a 12 mm <sup>2</sup> LED chip, thermistor and connector mounted on a copper-core PCB.
PT-120-RA-L11-MPF <sup>3</sup>		5E	
PT-120-RA-L11-MPG <sup>3</sup>		5F	
PT-120-RA-L11-MPH <sup>3</sup>		5G	
PT-120-RAX-L15-MPH	RAX	5H	Red-Amber LED, consisting of a 12 mm <sup>2</sup> LED chip, thermistor and connector mounted on a copper-core PCB. ( Common cathode configuration ; reverse polarity pin out)
PT-120-RAX-L15-MPJ		5J	
PT-120-RAX-L15-MPK		5K	
PT-120-RAX-L15-MPL		5L	
PT-120-G-L11-MPK	Green	5J	Green LED, consisting of a 12 mm <sup>2</sup> LED chip, thermistor and connector mounted on a copper-core PCB.
PT-120-G-L11-MPL		5K	
PT-120-G-L11-MPM		5L	
PT-120-G-L11-MPN		5M	
PT-120-B-L11-EPDnnn	Blue	5F	Blue LED, consisting of a 12 mm <sup>2</sup> LED chip, thermistor and connector mounted on a copper-core PCB (nnn=DW bin - refer to table below for definition).
PT-120-B-L11-EPEnnn		5G	
PT-120-B-L11-EPFnnn		5H	
PT-120-B-L11-EPGnnn		5J	

Note 1: Ordering part numbers represent bin kits (group of bins that are shippable for a given ordering part number)

Note 2: See Bin Kit and Flux bin definitions on page 4.

Note 3: Not recommended for new designs.

### PT-120 Blue Dominant Wavelength Bin Definition

Blue Dominant Wavelength Bin Designator <sup>1</sup> nnn	Blue Dominant Wavelength Bins		
	WY (450 nm - 454 nm)	WX (454 nm - 462 nm)	WZ (462 nm - 468 nm)
None	<input checked="" type="checkbox"/>	<input checked="" type="checkbox"/>	<input checked="" type="checkbox"/>
101		<input checked="" type="checkbox"/>	
102	<input checked="" type="checkbox"/>	<input checked="" type="checkbox"/>	
103		<input checked="" type="checkbox"/>	<input checked="" type="checkbox"/>

Note 1: See page 3 for examples of ordering part numbers for PT-120 Blue on Ordering Part Number Nomenclature section.

### Ordering Part Number Nomenclature

PT — mm — XXXX — L11 — XYZ

Product Family	Chip Area	Color	Package Configuration	Bin Kit <sup>1</sup>
PT: Copper-core PCB	120: 12 mm <sup>2</sup>	R= Red (623nm, typ) <sup>2</sup> RA= Red-Amber(613nm, typ) <sup>2</sup> RAX=Red-Amb(613nm,typ) G= Green B= Blue	L11: 28 mm x 26.75 mm L15: 28 mm x 26.75 mm (reverse polarity) See Mechanical Drawing section	See page 4 for bin kit definition

Note 1: A Bin Kit represents a group of individual flux or power bins that are shippable for a given ordering part number. Individual flux bins are not orderable.

EXAMPLES: PT-120-G-L11-MPK is comprised of Green Flux Bins 5J, 5K, 5L, 5M, 5N, 5P  
 PT-120-B-L11-EPD is comprised of Blue Flux Bins 5F, 5G, 5H, 5J, 5K and DWL bins WY, WX, WZ (DWL range 450nm-468nm)  
 PT-120-B-L11-EPD101 is comprised of Blue Flux Bins 5F, 5G, 5H, 5J, 5K and DWL bins WX only (DWL range 454nm-462nm)

Note 2: **Product is END-OF-LIFE. Contact Luminus for more information.**

**PT-120 Bin Kit<sup>1</sup> and Flux Bin<sup>2,3,4</sup> Definitions**

Note: Please refer to ordering part number table on page 3 for Bin Kit availability.

Red Flux Bins <sup>6</sup>	Bin 5C	Bin 5D	Bin 5E	Bin 5F	Bin 5G	Bin 5H	Bin 5J		
Red Bin Flux Range <sup>4</sup> (lm)	1490-1630	1630-1760	1760-1900	1900-2025	2025-2150	2150-2300	2300-2450		
PT-120-R-L11-MPD <sup>6</sup>	<input checked="" type="checkbox"/>	<input checked="" type="checkbox"/>	<input checked="" type="checkbox"/>	<input checked="" type="checkbox"/>	<input checked="" type="checkbox"/>				
PT-120-R-L11-MPE <sup>6</sup>		<input checked="" type="checkbox"/>	<input checked="" type="checkbox"/>	<input checked="" type="checkbox"/>	<input checked="" type="checkbox"/>	<input checked="" type="checkbox"/>			
PT-120-R-L11-MPF <sup>6</sup>			<input checked="" type="checkbox"/>	<input checked="" type="checkbox"/>	<input checked="" type="checkbox"/>	<input checked="" type="checkbox"/>	<input checked="" type="checkbox"/>		
Red -Amber Flux Bins <sup>6</sup>	Bin 5D	Bin 5E	Bin 5F	Bin 5G	Bin 5H	Bin 5J	Bin 5K	Bin 5L	
Red -Amber (RA ) Bin Flux Range <sup>4</sup> (lm)	1630-1760	1760-1900	1900-2025	2025-2150	2150-2300	2300-2450	2450-2625	2625-2800	
PT-120-RA-L11-MPE <sup>6</sup>	<input checked="" type="checkbox"/>	<input checked="" type="checkbox"/>	<input checked="" type="checkbox"/>	<input checked="" type="checkbox"/>	<input checked="" type="checkbox"/>				
PT-120-RA-L11-MPF <sup>6</sup>		<input checked="" type="checkbox"/>	<input checked="" type="checkbox"/>	<input checked="" type="checkbox"/>	<input checked="" type="checkbox"/>	<input checked="" type="checkbox"/>			
PT-120-RA-L11-MPG <sup>6</sup>			<input checked="" type="checkbox"/>	<input checked="" type="checkbox"/>	<input checked="" type="checkbox"/>	<input checked="" type="checkbox"/>	<input checked="" type="checkbox"/>		
PT-120-RA-L11-MPH <sup>6</sup>				<input checked="" type="checkbox"/>	<input checked="" type="checkbox"/>	<input checked="" type="checkbox"/>	<input checked="" type="checkbox"/>	<input checked="" type="checkbox"/>	
RAX Flux Bins	Bin 5H	Bin 5J	Bin 5K	Bin 5L	Bin 5M	Bin 5N	Bin 5P	Bin 5Q	
RAX Bin Flux Range <sup>4</sup> (lm)	2150-2300	2300-2450	2450-2625	2625-2800	2800-3000	3000-3200	3200-3400	3400-3600	
PT-120-RAX-L15-MPH	<input checked="" type="checkbox"/>	<input checked="" type="checkbox"/>	<input checked="" type="checkbox"/>	<input checked="" type="checkbox"/>	<input checked="" type="checkbox"/>				
PT-120-RAX-L15-MPJ		<input checked="" type="checkbox"/>	<input checked="" type="checkbox"/>	<input checked="" type="checkbox"/>	<input checked="" type="checkbox"/>	<input checked="" type="checkbox"/>			
PT-120-RAX-L15-MPK			<input checked="" type="checkbox"/>	<input checked="" type="checkbox"/>	<input checked="" type="checkbox"/>	<input checked="" type="checkbox"/>	<input checked="" type="checkbox"/>		
PT-120-RAX-L15-MPL				<input checked="" type="checkbox"/>	<input checked="" type="checkbox"/>	<input checked="" type="checkbox"/>	<input checked="" type="checkbox"/>	<input checked="" type="checkbox"/>	
Green Flux Bins	Bin 5J	Bin 5K	Bin 5L	5M	5N	5P	5Q		
Green Bin Flux Range <sup>4</sup> (lm)	4200-4400	4400-4650	4650-4900	4900-5200	5200-5500	5500-5825	5825-6200		
PT-120-G-L11-MPK	<input checked="" type="checkbox"/>	<input checked="" type="checkbox"/>	<input checked="" type="checkbox"/>	<input checked="" type="checkbox"/>	<input checked="" type="checkbox"/>	<input checked="" type="checkbox"/>			
PT-120-G-L11-MPL		<input checked="" type="checkbox"/>	<input checked="" type="checkbox"/>	<input checked="" type="checkbox"/>	<input checked="" type="checkbox"/>	<input checked="" type="checkbox"/>	<input checked="" type="checkbox"/>		
PT-120-G-L11-MPM			<input checked="" type="checkbox"/>	<input checked="" type="checkbox"/>	<input checked="" type="checkbox"/>	<input checked="" type="checkbox"/>	<input checked="" type="checkbox"/>		
PT-120-G-L11-MPN				<input checked="" type="checkbox"/>	<input checked="" type="checkbox"/>	<input checked="" type="checkbox"/>	<input checked="" type="checkbox"/>		
Blue Power Bins	Bin 5F	Bin 5G	Bin 5H	Bin 5J	Bin 5K	Bin 5L	5M	5N	
Blue Bin Flux Range <sup>5</sup> (lm)	750-815	815-880	880-940	940-1000	1000-1070	1070-1145	1145-1220	1220-1300	
PT-120-B-L11-EPDnnn	<input checked="" type="checkbox"/>	<input checked="" type="checkbox"/>	<input checked="" type="checkbox"/>	<input checked="" type="checkbox"/>	<input checked="" type="checkbox"/>				
PT-120-B-L11-EPEnnn		<input checked="" type="checkbox"/>	<input checked="" type="checkbox"/>	<input checked="" type="checkbox"/>	<input checked="" type="checkbox"/>	<input checked="" type="checkbox"/>			
PT-120-B-L11-EPFnnn			<input checked="" type="checkbox"/>	<input checked="" type="checkbox"/>	<input checked="" type="checkbox"/>	<input checked="" type="checkbox"/>	<input checked="" type="checkbox"/>		

Note 1: Bin Kits are defined by a group of flux or power bins. Only one flux bin will be shipped in each individual pack. A shipment will contain packs of different allowed flux bins for a particular ordering part number. In order to ensure availability, individual Flux or Power bins are not orderable.

Note 2: PT-120 LEDs are tested for luminous flux at 30 A at 25% duty cycle for Red, and Blue, and at 50% duty cycle for Green Devices. Devices are sorted and packed by flux bin. Not all flux bins are currently populated.

Note 3: Luminus maintains a test measurement accuracy for LED flux and power of +/- 6%.

Note 4: Red and Green Flux bin limits apply across entire dominant wavelength range. Dominant wavelength range for Red and Green devices are specified on the Optical & Electrical Characteristics section.

Note 5: Blue Flux bin limits are defined at dominant wavelength, 462 nm.

Note 6: **Product is End-of-Life. Contact Luminus for more information.**

### Optical & Electrical Characteristics

General Characteristics		Symbol	Red <sup>8</sup>	Red -Amber <sup>8</sup>	RAX	Green	Blue	Unit
Emitting Area			11.96	11.96	11.96	11.96	11.96	mm <sup>2</sup>
Emitting Area Dimensions			4.6 x 2.6	4.6 x 2.6	4.6 x 2.6	4.6 x 2.6	4.6 x 2.6	mm x mm
Characteristics at Recommended Test Drive Current , I <sub>F</sub> <sup>1,2</sup>								
Reference Duty Cycle <sup>3</sup>			25	25	25	50	25	%
Test Peak Drive Current <sup>1,2,4</sup>	typ	I <sub>F</sub>	30	30	30	30	30	A
Peak Luminous Flux <sup>1,2,5</sup>	typ	Φ <sub>v</sub>	1625	2100	3000	5200	1000	lm
Peak Radiometric Flux <sup>1,2</sup>	typ	Φ <sub>r</sub>	9.2	8.3	9.4	10.6	21	W
Dominant Wavelength	min	λ <sub>dmin</sub>	619	609	609	516	450	nm
	typ	λ <sub>d</sub>	623	613	613	525	460	nm
	max	λ <sub>dmax</sub>	630	620	620	540	468	nm
FWHM- Spectral bandwidth at 50% of Φ <sub>v</sub>	typ		19	19	19	34	20	nm
Chromaticity Coordinates <sup>6,7</sup>	typ	x	0.698	0.675	0.675	0.167	0.147	
	typ	y	0.302	0.325	0.325	0.704	0.033	
Forward Voltage	min	V <sub>Fmin</sub>	2.2	2.2	2.3	3.5	3.2	V
	typ	V <sub>F</sub>	2.6	2.6	3.1	5.2	3.9	V
	max	V <sub>Fmax</sub>	3.2	3.2	3.7	5.9	5.2	V
Device Thermal Characteristics								
Thermal Coefficient of Photometric Flux	typ		-1	-1	-1	-0.2	-0	% / °C
Thermal Coefficient of Radiometric Flux	typ		-0.7	-0.7	0.7	-0.2	-0.2	% / °C
Forward Voltage Temperature Coefficient	typ		-1.6	-1.6	-2	-2	-3	mV / °C
Characteristics at Reference Continuous Drive Current I <sub>F</sub> (continuous wave) <sup>1</sup>								
Reference Drive Current	typ	I <sub>F</sub>	18	18	18	18	18	A
Luminous Flux	typ	Φ <sub>v</sub>	910	1175	1485	3640	720	lm
Radiometric Flux	typ	Φ <sub>r</sub>	5.2	4.6	5.3	7.0	14	W
Dominant Wavelength	typ	λ <sub>d</sub>	624	612	612	528	461	nm
FWHM -Spectral bandwidth at 50% of Φ <sub>v</sub>	typ		18	18	18	36	21	nm
Chromaticity Coordinates <sup>6,7</sup>	typ	x	0.700	0.677	0.677	0.177	0.144	nm
	typ	y	0.300	0.322	0.322	0.713	0.034	nm
Forward Voltage	typ	V <sub>F</sub>	2.3	2.3	2.7	4.7	3.4	V

For Notes, see following page

## Optical & Electrical Characteristics *(continued)*

Note 1: All ratings are based on testing conditions with a constant heat sink temperature  $T_{hs} = 40^{\circ}\text{C}$ . See Thermal Resistance section for  $T_{hs}$  definition.

Note 2: Parameters rated at test duty cycle and Pulsed operation frequency  $f > 240\text{ Hz}$ ;  $DC = \frac{t}{T}$

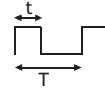

Note 3: Duty Cycle used to specify device ratings under Pulsed operation. Luminus LED devices can operate at duty cycles ranging from 1% to 100%. At higher duty cycles, drive current should be adjusted to maintain the junction temperature at desired levels to meet the application lifetime requirements.

Note 4: In pulsed operation, rise time from 10 to 90% of forward current should be larger than 0.5 microseconds

Note 5: For Blue devices, total flux from emitting area at typical dominant wavelength. Refer to page 7 for brightness specifications at other wavelength

Note 6: CIE 1931 chromaticity diagram coordinates, normalized to  $X+Y+Z=1$

Note 7: For reference only

Note 8: **Product is END-OF-LIFE. Contact Luminus for more information.**

### Absolute Maximum Ratings

	Symbol	Red <sup>5</sup>	Red - Amber <sup>5</sup>	RAX	Green	Blue	Unit
Absolute Minimum Current (CW or Pulsed) <sup>1</sup>		200	200	200	200	200	mA
Absolute Maximum Current (CW) <sup>2</sup>		27	27	27	27	27	A
Absolute Maximum Current (Pulsed) <sup>2,3</sup> (Frequency > 240 Hz, duty cycle < 70%)		36	36	36	36	36	A
Absolute Maximum Surge Current <sup>2,3</sup> (Frequency > 240 Hz, duty cycle = 10%, t=1ms)		42	42	42	42	42	A
Maximum Operating Junction Temperature <sup>4</sup>		100	100	100	140	130	$^{\circ}\text{C}$
Absolute Maximum Junction Temperature <sup>4</sup>	$T_{jmax}$	125	125	125	170	170	$^{\circ}\text{C}$
Storage Temperature Range		-40 / +100	-40 / +100	-40 / +100	-40 / +100	-40 / +100	$^{\circ}\text{C}$

Note 1: Product performance and lifetime data is specified at recommended forward drive currents. Sustained operation at or near absolute minimum currents may result in a reduction of device performance and device lifetime compared to recommended forward drive currents.

Note 2: Maximum forward drive current conditions for continuous operation are 27 A, CW (2.2 A/mm<sup>2</sup>), and 36A,  $f > 240\text{ Hz}$ , duty cycle < 70% (3.0 A/mm<sup>2</sup>). Sustained operation above maximum currents is not recommended and will result in a reduction of device lifetime compared to specified maximum forward drive currents. Device lifetimes will depend on junction temperature. (See Reliability Application Note, APN-001444 for product lifetimes as function of junction temperature.) Please refer to lifetime de-rating curves (available from Luminus) for further information.

Note 3: In pulsed operation, rise time from 10 to 90% of forward current should be larger than 0.5 microseconds.

Note 4: Sustained operation at Absolute Maximum Operating Junction Temperature ( $T_{jmax}$ ) will result in reduced device life time.

Note 5: **Product is END-OF-LIFE. Contact Luminus for more information.**

### Blue Bin Flux Ranges by Dominant Wavelength <sup>1,2</sup>

DWL	Bin 5F		Bin 5G		Bin 5H		Bin 5J		Bin 5K		Bin 5L		Bin 5M		Bin 5N	
	Min (lm)	Max (lm)	Min (lm)	Max (lm)	Min (lm)	Max (lm)	Min (lm)	Max (lm)	Min (lm)	Max (lm)	Min (lm)	Max (lm)	Min (lm)	Max (lm)	Min (lm)	Max (lm)
450	367	398	398	430	430	459	459	489	489	523	523	560	560	596	596	635
451	399	433	433	468	468	500	500	531	531	569	569	608	608	648	648	691
452	431	468	468	505	505	540	540	574	574	614	614	657	657	700	700	746
453	462	503	503	543	543	580	580	617	617	660	660	706	706	752	752	802
454	494	537	537	580	580	620	620	659	659	705	705	755	755	804	804	857
455	526	572	572	618	618	660	660	702	702	751	751	804	804	856	856	912
456	558	607	607	655	655	700	700	744	744	797	797	852	852	908	908	968
457	590	641	641	693	693	740	740	787	787	842	842	901	901	960	960	1023
458	622	676	676	730	730	780	780	830	830	888	888	950	950	1012	1012	1078
459	654	711	711	768	768	820	820	872	872	933	933	999	999	1064	1064	1134
460	686	746	746	805	805	860	860	915	915	979	979	1047	1047	1116	1116	1189
461	718	780	780	843	843	900	900	957	957	1024	1024	1096	1096	1168	1168	1245
462	750	815	815	880	880	940	940	1000	1000	1070	1070	1145	1145	1220	1220	1300
463	782	850	850	917	917	980	980	1043	1043	1116	1116	1194	1194	1272	1272	1355
464	814	884	884	955	955	1020	1020	1085	1085	1161	1161	1243	1243	1324	1324	1411
465	846	919	919	992	992	1060	1060	1128	1128	1207	1207	1291	1291	1376	1376	1466
466	878	954	954	1030	1030	1100	1100	1170	1170	1252	1252	1340	1340	1428	1428	1522
467	910	989	989	1067	1067	1140	1140	1203	1203	1298	1298	1389	1389	1480	1480	1577
468	942	1023	1023	1105	1105	1180	1180	1256	1256	1343	1343	1438	1438	1532	1532	1632

Note 1: Flux Min, Max values are continuous as function of dominant wavelength values. For illustration purposes, flux Min and Max values are provided at discrete dominant wavelength values.

Note 2: Luminus maintains a test measurement accuracy for LED flux and power of +/- 6%.

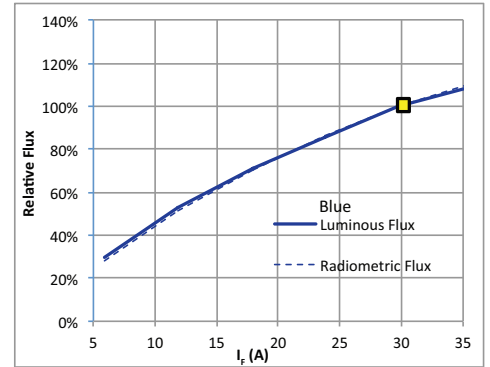
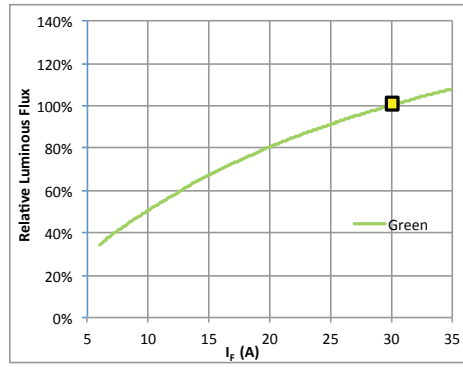
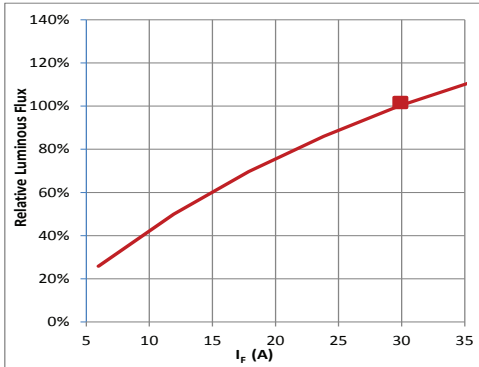

**Normalized Luminous Flux variation with Forward Current:  $\Phi_v(I_F) / \Phi_v(30A)$** 

See notes 1, 2 on page 9.

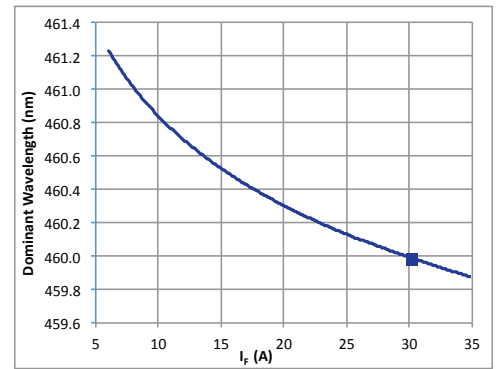
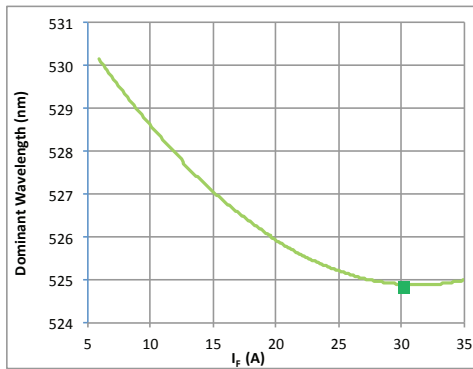
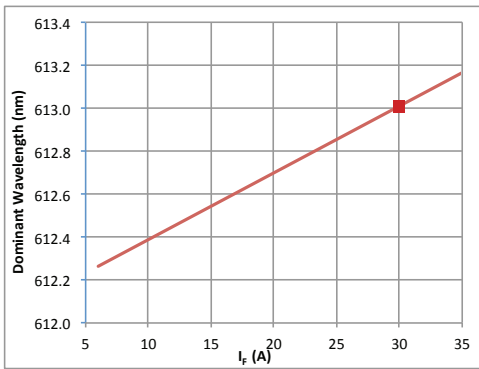
**Dominant Wavelength variation with Forward Current -  $\lambda_d = f(I_F)$  - Typical**

See notes 1, 2 on page 9.

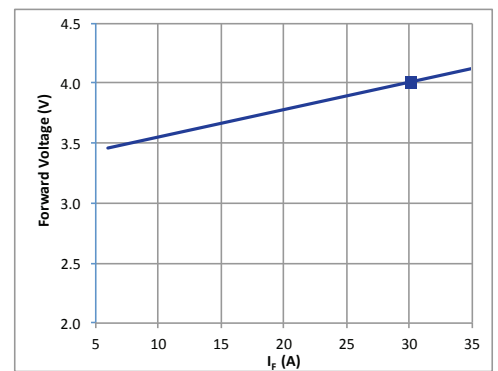
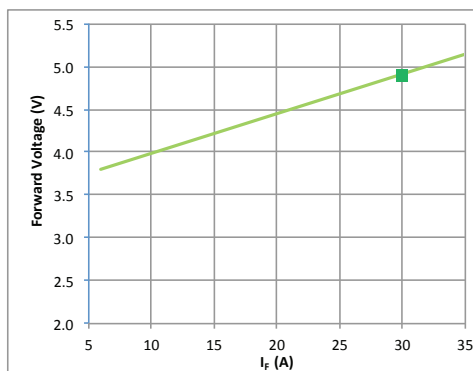
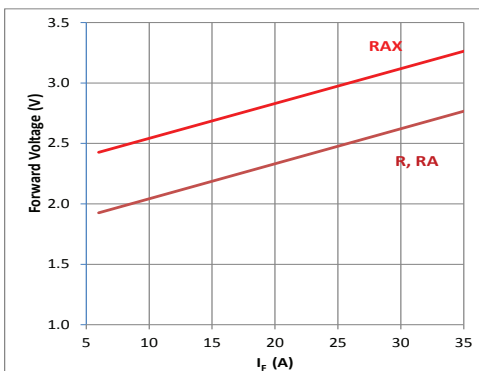
**Forward Voltage variation with Drive current -  $V_F = f(I_F)$  - Typical**

See notes 1, 2 on page 9.

## Optical Spectrum (Typical)

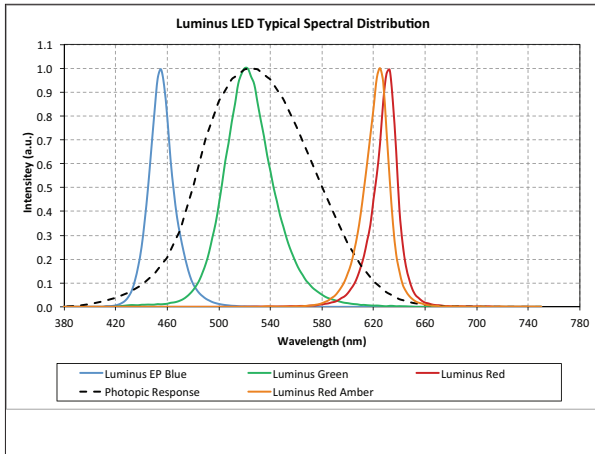

See notes 1, 3 on page 9.

## Angular Intensity Distribution (Typical)

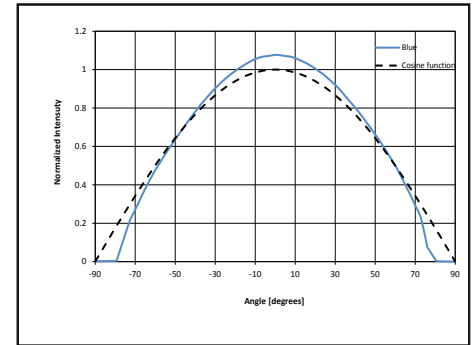
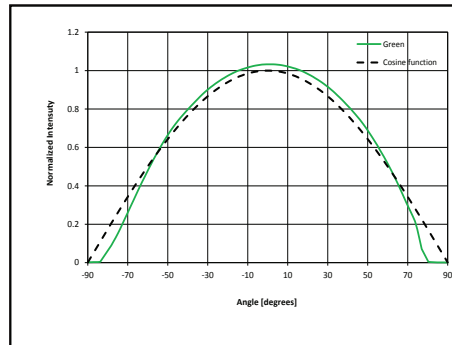
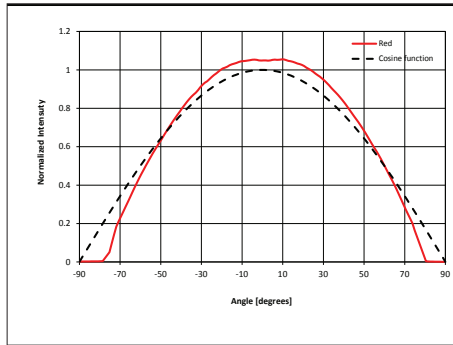

See note 4 on page 9.

Note 1: For Pulsed operation, the reference R,G, and B duty cycles used are 25%, 50% and 25% respectively ( $T_{hs}=40^{\circ}\text{C}$ ; Frequency =720 Hz).

Note 2: Square on curves indicate device operating current point (30A) under reference conditions listed in the Optical and Electrical Characteristics table.

Note 3: Typical spectrum at recommended peak drive current . Please contact Luminus to obtain data in Excel format.

Note 4: For any specific device, slight variations in angular intensity distribution may be expected.

## Thermal Resistance

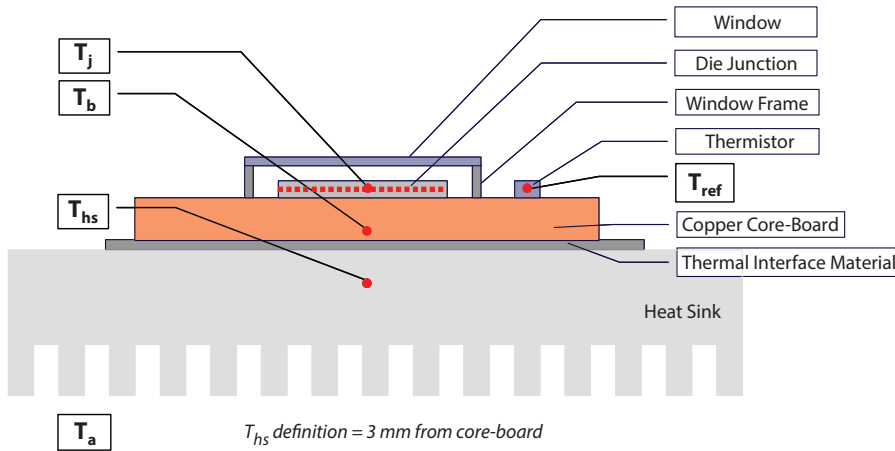

## Typical Thermal Resistance

$R_{\theta j-b}^1$	0.4° C/W
$R_{\theta b-hs}^2$	0.1 °C/W
$R_{\theta j-hs}^{1,2}$	0.5 °C/W
$R_{\theta j-ref}^2$	0.4 °C/W

Note 1: Thermal resistance values are measured in accordance to JEDEC Standards JESD51-14 and JESD51-5x series.

Note 2: Thermal Resistance is based on eGraf 1205 Thermal interface.

## Thermistor Information

The thermistor (used in PT-120 devices, they are mounted on coreboards) is from Murata Manufacturing Co. The global part number is NCP18XH103J03RB.

Please contact Luminus for information on use of the thermistor and for data in Excel format for temperature vs resistance plot below.

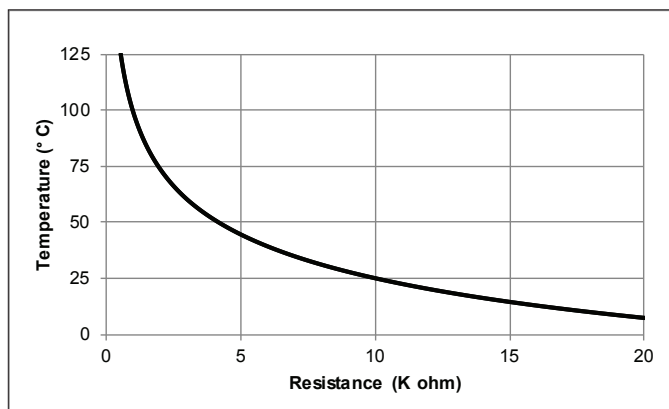

## Electrical Pinout

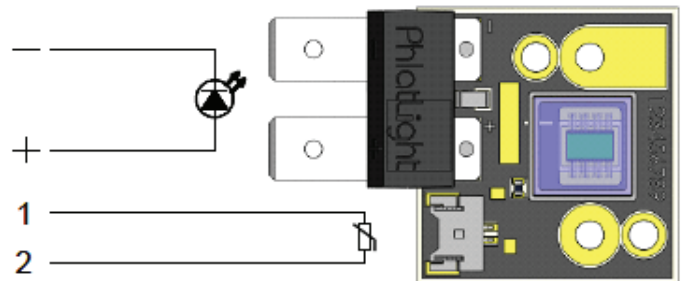

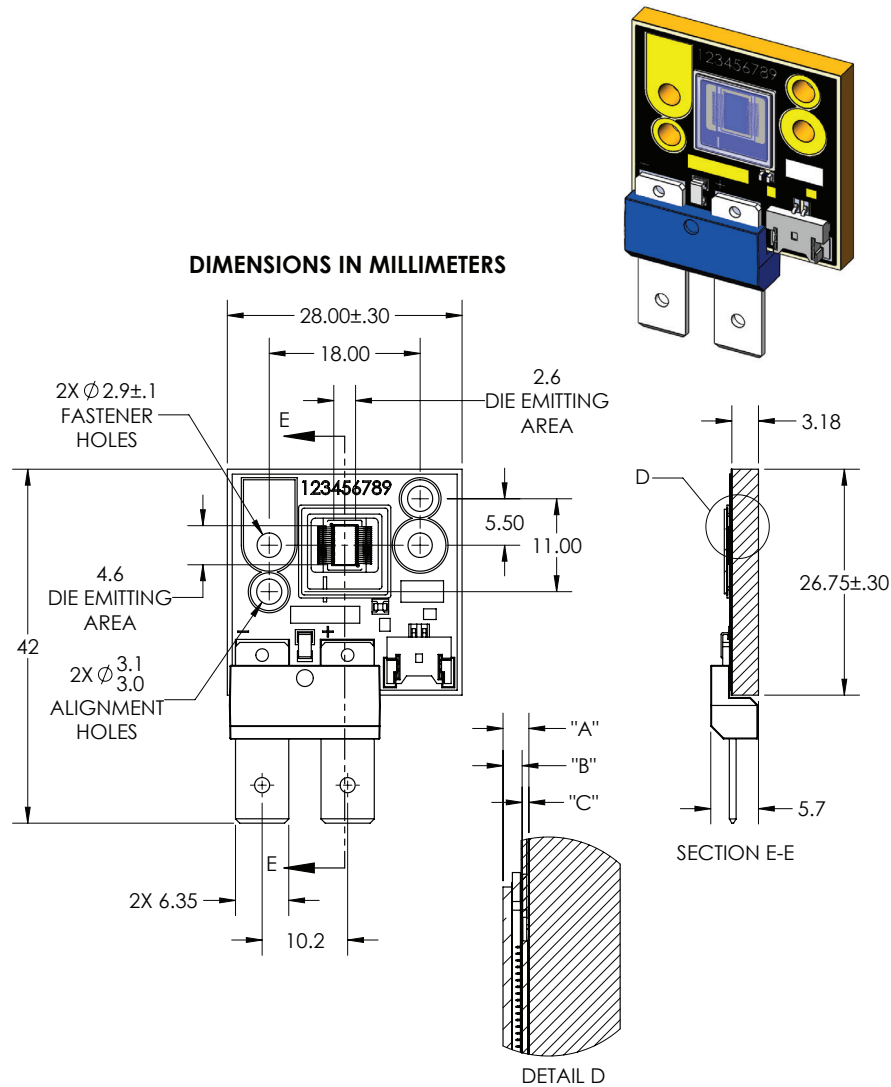
**Mechanical Dimensions for PT120 - Red (R)<sup>4</sup>, Red - Amber (RA)<sup>4</sup>, Green and Blue**

DIMENSION NAME	DESCRIPTION	NOMINAL DIMENSION	TOLERANCE
"A"	TOP OF METAL SUBSTRATE TO TOP OF WINDOW	.88	$\pm .13$
"B"	TOP OF DIE EMITTING AREA TO TOP OF WINDOW	.65	$\pm .11$
"C"	TOP OF METAL SUBSTRATE TO TOP OF DIE EMITTING AREA	.23	$\pm .02$

DWG-002051

**Notes:**

- 1) Recommended connector for Anode and Cathode: Panduit Disco Lok™ Series P/N: DNG14-250FIB-C or JST Manufacturing Co: SPS-61T-250 or equivalent
- 2) Thermistor Connector: Global Connector Technology (GCT) P/N WTB08-021S-F. Recommended Female: (GCT) P/N WTB06-020H-A or equivalent
- 3) For detailed drawing of the PT-120 package, please refer to the DWG-002051 mechanical specification document
- 4) **Product is END-OF-LIFE. Contact Luminus for more information.**

## Mechanical Dimensions for PT120- RAX Device

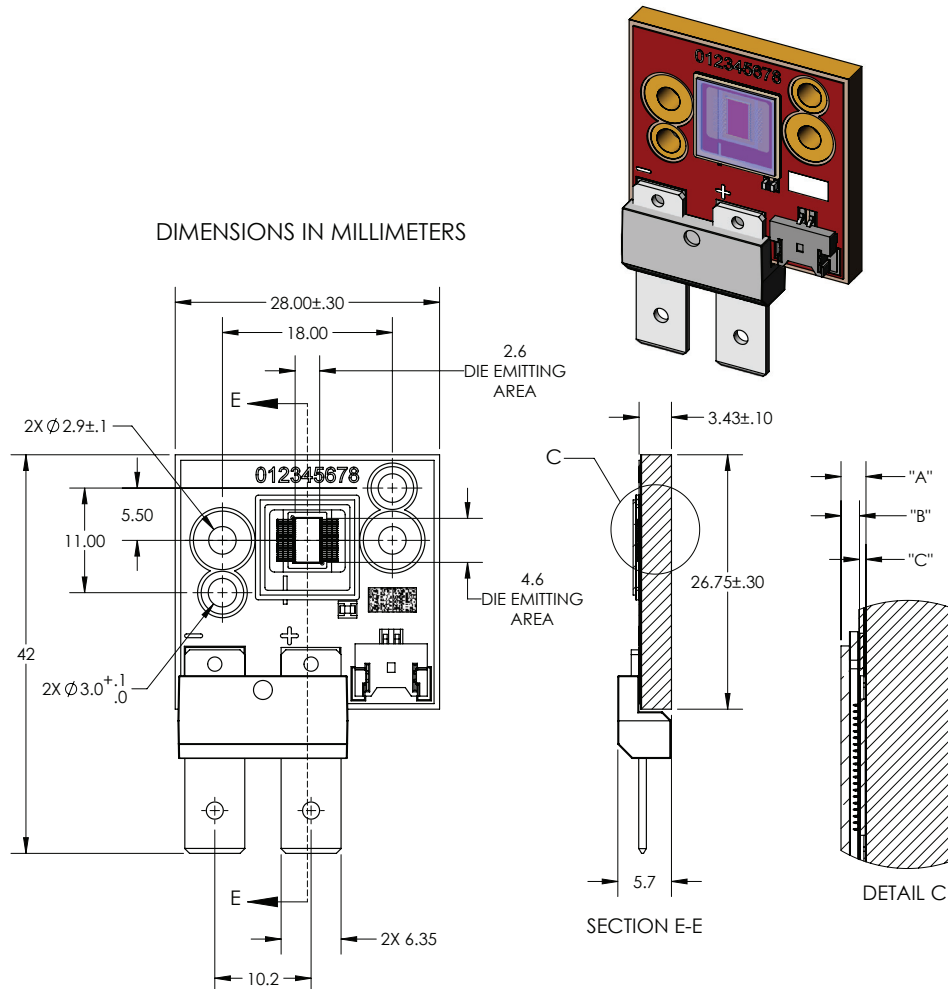

DIMENSION NAME	DESCRIPTION	NOMINAL DIMENSION	TOLERANCE
"A"	TOP OF METAL SUBSTRATE TO TOP OF WINDOW	.88	±.13
"B"	TOP OF DIE EMITTING AREA TO TOP OF WINDOW	.65	±.11
"C"	TOP OF METAL SUBSTRATE TO TOP OF DIE EMITTING AREA	.23	±.02

DWG-002189

**Notes:**

- 1) Recommended connector for Anode and Cathode: Panduit Disco Lok™ Series P/N: DNG14-250FIB-C or JST Manufacturing Co: SPS-61T-250 or equivalent
- 2) Thermistor Connector: Global Connector Technology (GCT) P/N WTB08-021S-F. Recommended Female: (GCT) P/N WTB06-020H-A or equivalent
- 3) For detailed drawing of the PT-120 RAX package, please refer to the DWG-002189 mechanical specification document

For detailed drawing of shipping trays, please refer to document TO-0479, available upon request.

## Shipping Tray Outline

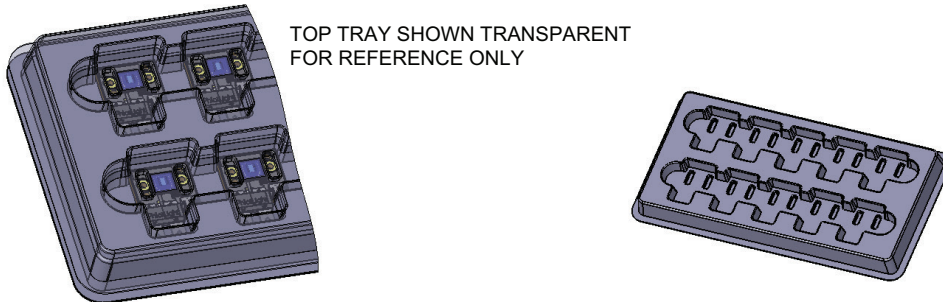
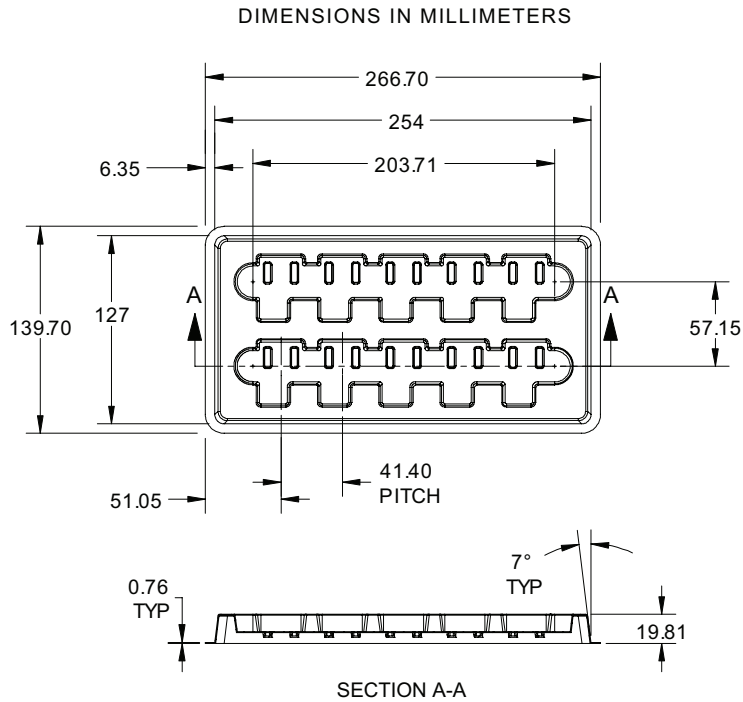

For detailed drawing of shipping trays, please refer to document TO-0479, available upon request.

## Packing and Shipping Specification (PT-120)

### Packing Specification

Packing Configuration	Qty /Pack	Reel Dimensions (diameter x W, mm)	Gross Weight (kg)
Stack of 5 trays with 10 devices per tray Each pack is enclosed in ESD bag	50	150 x 280 x 85	2.7

### Product Label Specification

#### Label Fields (subject to change):

- 6-8 digit Box number (for Luminus internal use)
- Luminus ordering part number
- Quantity of devices in pack
- Part number revision (for Luminus internal use)
- Customer's part number (optional)
- Flux Bin
- 2D Bar code





**LUMINUS**  
LEADER IN BIG CHIP LEDS    Solid State Filament™

BT-012345  
  
Box number

PT-120-G-L11-MPG  
  
Luminus part number

12345678  
  
Customer part number

5F  
  
Bin

Qty: 50  

Rev 01  



for traceability peel off label and attach

**RoHS Compliant**

*Sample label –for illustration only*

### Shipping Box

Shipping Box	Quantity	Material	Dimensions (L x W x H, mm)
Carton Box	1 -20 packs (50 - 1000 Devices)	S4651	560 x 560 x 200



### History of Changes

Rev		Description of Change
01	7/24/12	Preliminary Specification
02	9/4/12	Update ordering part numbers
03	3/8/13	Update characterization curves
04	4/11/14	Update Absolute Maximum Ratings table and blue flux bin kits
05	9/12/14	Add PT-120-RAX preliminary product specifications and update PT-120 drawings
06	10/19/16	Remove various "preliminary" notations surrounding -RAX product. Added "END-OF-LIFE" notation around -R and -RA product. Updated CPN table with new -RAX CPN. Updated document to reflect Luminus new address / contact info.
07	10/10/19	Updated Blue typical flux and radiometric power to reflect current product distribution

The products, their specifications and other information appearing in this document are subject to change by Luminus Devices without notice. Luminus Devices assumes no liability for errors that may appear in this document, and no liability otherwise arising from the application or use of the product or information contained herein. None of the information provided herein should be considered to be a representation of the fitness or suitability of the product for any particular application or as any other form of warranty. Luminus Devices' product warranties are limited to only such warranties as accompany a purchase contract or purchase order for such products. Nothing herein is to be construed as constituting an additional warranty. No information contained in this publication may be considered as a waiver by Luminus Devices of any intellectual property rights that Luminus Devices may have in such information.

This product is protected by U.S. Patents 6,831,302; 7,074,631; 7,083,993; 7,084,434; 7,098,589; 7,105,861; 7,138,666; 7,166,870; 7,166,871; 7,170,100; 7,196,354; 7,211,831; 7,262,550; 7,274,043; 7,301,271; 7,341,880; 7,344,903; 7,345,416; 7,348,603; 7,388,233; 7,391,059 Patents Pending in the U.S. and other countries.