

**Ordering number CA13270_LAURA-SS-WAS**

Family	Laura	FWHM	asymmetric degrees
Type	Assembly	Efficiency	92 %
LED	LUXEON Rebel	cd/lm	13.300
Color	White	Gerber File	Available
Diameter	21.6x21.6 mm		
Height	12.9 mm		
Style	Square		
Optic Material	PMMA		
Holder Material	PC		
Fastening	Tape		
Status	Ready		

Ordering number CA13272_LAURA-O-WAS

Family	Laura	FWHM	Asym degrees
Type	Assembly	Efficiency	(simulated) 87 %
LED	LUXEON Rebel	cd/lm	3.100
Color	White	Gerber File	Available
Diameter	21.6x21.6 mm		
Height	12.9 mm		
Style	Square		
Optic Material	PMMA		
Holder Material	PC		
Fastening	Tape		
Status	Ready		

Ordering number CA13307_LAURA-O-WAS-PIN

Family	Laura	FWHM	Asym degrees
Type	Assembly	Efficiency	87 %
LED	LUXEON Rebel	cd/lm	3.100
Color	White	Gerber File	Available
Diameter	21.6x21.6 mm		
Height	13.1 mm		
Style	Square		
Optic Material	PMMA		
Holder Material	PC		
Fastening	Pin, tape		
Status	Ready		

Ordering number CP13308_LAURA-O-WAS-PG

Family	Laura	FWHM	Asym degrees
Type	Assembly	Efficiency	87 %
LED	LUXEON Rebel	cd/lm	3.100
Color	White	Gerber File	Available
Diameter	21.6x21.6 mm		
Height	12.9 mm		
Style	Square		
Optic Material	PMMA		
Holder Material	PC		
Fastening	Pin, glue		
Status	Ready		

**Ordering number CP13311_Laura-SS-WAS-PG**

Family	Laura	FWHM	Asym degrees
Type	Assembly	Efficiency	92 %
LED	LUXEON Rebel	cd/lm	13.300
Color	White	Gerber File	Available
Diameter	21.6x21.6 mm		
Height	12.9 mm		
Style	Square		
Optic Material	PMMA		
Holder Material	PC		
Fastening	Pin, glue		
Status	Ready		

**Ordering number CA13312_Laura-SS-WAS-PIN**

Family	Laura	FWHM	Asym degrees
Type	Assembly	Efficiency	92 %
LED	LUXEON Rebel	cd/lm	13.300
Color	White	Gerber File	Available
Diameter	21.6x21.6 mm		
Height	13.1 mm		
Style	Square		
Optic Material	PMMA		
Holder Material	PC		
Fastening	Pin, tape		
Status	Ready		

**Ordering number CX11352_Laura-RS**

Family	Laura	FWHM	7 degrees
Type	Pack	Efficiency	93 %
LED	LUXEON Rebel	cd/lm	34.000
Color	White	Gerber File	Available
Diameter	21.6 mm		
Height	12.9 mm		
Style	Square		
Optic Material	PMMA		
Holder Material	PC		
Fastening	Tape		
Status	Ready		

**Ordering number CA11959_Laura-RS-PIN**

Family	Laura	FWHM	7 degrees
Type	Assembly	Efficiency	93 %
LED	LUXEON Rebel	cd/lm	34.000
Color	White	Gerber File	Available
Diameter	21.6 x 21.6 mm		
Height	13.1 mm		
Style	Square		
Optic Material	PMMA		
Holder Material	PC		
Fastening	Pin, tape		
Status	Ready		

**Ordering number CX11645_LAURA-SS**

Family	Laura	FWHM	10 degrees
Type	Pack	Efficiency	93 %
LED	LUXEON Rebel	cd/lm	14.200
Color	White	Gerber File	Available
Diameter	21.6 mm		
Height	12.9 mm		
Style	Square		
Optic Material	PMMA		
Holder Material	PC		
Fastening	Tape		
Status	Ready		

**Ordering number CA12011_LAURA-SS-PIN**

Family	Laura	FWHM	11 degrees
Type	Assembly	Efficiency	92 %
LED	LUXEON Rebel	cd/lm	16.000
Color	White	Gerber File	Available
Diameter	21.6 + 21.6 mm		
Height	13.1 mm		
Style	Square		
Optic Material	PMMA		
Holder Material	PC		
Fastening	Pin, tape		
Status	Ready		

**Ordering number CX11359_LAURA-D**

Family	Laura	FWHM	15 degrees
Type	Pack	Efficiency	90 %
LED	LUXEON Rebel	cd/lm	5.000
Color	White	Gerber File	Available
Diameter	21.6X21.6 mm		
Height	12.9 mm		
Style	Square		
Optic Material	PMMA		
Holder Material	PC		
Fastening	Tape		
Status	Ready		

**Ordering number CA11960_LAURA-D-PIN**

Family	Laura	FWHM	15 degrees
Type	Assembly	Efficiency	90 %
LED	LUXEON Rebel	cd/lm	5.000
Color	White	Gerber File	Available
Diameter	21.6 + 21.6 mm		
Height	13.1 mm		
Style	Square		
Optic Material	PMMA		
Holder Material	PC		
Fastening	Pin, tape		
Status	Ready		

**Ordering number CX11354_LAURA-M**

Family	Laura	FWHM	27 degrees
Type	Pack	Efficiency	88 %
LED	LUXEON Rebel	cd/lm	2.900
Color	White	Gerber File	Available
Diameter	21.6 mm		
Height	12.9 mm		
Style	Square		
Optic Material	PMMA		
Holder Material	PC		
Fastening	Tape		
Status	Ready		

**Ordering number CA11837_LAURA-M-PIN**

Family	Laura	FWHM	27 degrees
Type	Assembly	Efficiency	88 %
LED	LUXEON Rebel	cd/lm	2.900
Color	White	Gerber File	Available
Diameter	21.6 mm		
Height	13.1 mm		
Style	Square		
Optic Material	PMMA		
Holder Material	PC		
Fastening	Pin, tape		
Status	Ready		

**Ordering number CX12568_LAURA-W**

Family	Laura	FWHM	39 degrees
Type	Pack	Efficiency	88 %
LED	LUXEON Rebel	cd/lm	1.900
Color	White	Gerber File	Available
Diameter	21.6 mm		
Height	12.9 mm		
Style	Square		
Optic Material	PMMA		
Holder Material	PC		
Fastening	Tape		
Status	Ready		

**Ordering number CX11364_LAURA-O**

Family	Laura	FWHM	41+12 degrees
Type	Pack	Efficiency	90 %
LED	LUXEON Rebel	cd/lm	5.000
Color	White	Gerber File	Available
Diameter	21.6 mm		
Height	12.9 mm		
Style	Square		
Optic Material	PMMA		
Holder Material	PC		
Fastening	Tape		
Status	Ready		

**Ordering number CA12012_LAURA-O-PIN**

Family	Laura	FWHM	41+12 degrees
Type	Assembly	Efficiency	90 %
LED	LUXEON Rebel	cd/lm	5.000
Color	White	Gerber File	Available
Diameter	21.6 + 21.6 mm		
Height	13.1 mm		
Style	Square		
Optic Material	PMMA		
Holder Material	PC		
Fastening	Pin, tape		
Status	Ready		

**Ordering number CA12344_LAURA-W-PIN**

Family	Laura	FWHM	44 degrees
Type	Assembly	Efficiency	88 %
LED	LUXEON Rebel	cd/lm	1.800
Color	White	Gerber File	Available
Diameter	21.6 + 21.6 mm		
Height	13.1 mm		
Style	Square		
Optic Material	PMMA		
Holder Material	PC		
Fastening	Pin, tape		
Status	Ready		

**Ordering number CA12325_LAURA-WW-PIN**

Family	Laura	FWHM	56 degrees
Type	Assembly	Efficiency	(simulated) 0 %
LED	LUXEON Rebel	cd/lm	1.000
Color	White	Gerber File	Available
Diameter	21.6 mm		
Height	13.1 mm		
Style	Square		
Optic Material	PMMA		
Holder Material	PC		
Fastening	Pin, tape		
Status	Ready		

**Ordering number CX11768_LAURA-WW**

Family	Laura	FWHM	66 degrees
Type	Pack	Efficiency	93 %
LED	LUXEON Rebel	cd/lm	-
Color	White	Gerber File	Available
Diameter	21.6 mm		
Height	12.9 mm		
Style	Square		
Optic Material	PMMA		
Holder Material	PC		
Fastening	Tape		
Status	Ready		

**Ordering number CX11524_LAURA-R-W**

Family	Laura	FWHM	68 degrees
Type	Assembly	Efficiency	81 %
LED	LUXEON Rebel	cd/lm	-
Color	White	Gerber File	Available
Diameter	21.6 mm		
Height	12.9 mm		
Style	Square		
Optic Material	PC		
Holder Material	PC		
Fastening	Tape		
Status	Ready		

Ordering number CX12983_LAURA-R-XW

Family	Laura	FWHM	71 degrees
Type	Pack	Efficiency	87 %
LED	LUXEON Rebel	cd/lm	0.670
Color	White	Gerber File	Available
Diameter	21.6 + 21.6 mm		
Height	12.9 mm		
Style	Square		
Optic Material	PC		
Holder Material	PC		
Fastening	Tape		
Status	Ready		

NOTE: The typical divergence will be changed by different color, chip size and chip position tolerance. The typical total divergence is the full angle measured where the luminous intensity is half of the peak value.



PRODUCT DATASHEET

Laura series

last update 22/4/2013

PHILIPS
LUMILEDS

GENERAL INFORMATION

- Product series especially designed & optimized for LUXEON Rebel series of LEDs.
- Special care taken to make light distribution as uniform as possible.
- Lens material optical grade PMMA with high UV and temperature resistance. Allows use of high current and temperature conditions.

Please find more information about used material from below:

http://ledil.fi/sites/default/files/Documents/Technical/Material/PMMA%20N%20UL94_Yellow%20Card.pdf

<http://ledil.fi/sites/default/files/Documents/Technical/Material/PMMA%20N%20PLEXIGLAS-Datasheet.pdf>

- Lens material optical grade PC with high UV and temperature resistance (120 degrees of Celcius / 248 degrees of Fahrenheit). Allows use of high current and temperature conditions.

Please find more information about used materials from below:

http://ledil.fi/sites/default/files/Documents/Technical/Material/PC%20Makrolon%202400_2407_2456_2458-UL.pdf

- Reflector is made of aluminium coated PC (120 degrees of Celcius / 248 degrees of Fahrenheit) with protective lacquer (110 degrees of Celcius / 230 degrees of Fahrenheit).

- Optic holder molded by high quality PC material (120 dergees of Celcius / 248 degrees of Fahrenheit).

- Fastening to heat sink with a PU foam adhesive tape of automotive grade. Please find fastening details by clicking link: http://www.ledil.com/datasheets/DataSheet_TAPE.pdf

NOTE 1: We advise customer to ensure the suitability and sufficiency of the bond in the end product. For example, mechanical stress, vibration and holes on the surface of the circuit board weaken the strength of the tape.

NOTE 2: Assembly to the surface must be made straight, so the tape bonds constant and balanced with fastening surface. Slanted assembly might cause unbalanced bond to the surface. All surfaces where tape is applied must be clean, dry and free from grease and dirt.

If cleaning of PCB surfaces is needed, please follow strictly the cleaning instructions of your LED manufacturer - this is important as cleaning shall under no circumstances damage LEDs or other electronics components on the PCB.

Further note that optical components shall not be cleaned with any chemicals - only micro fiber cloth may be used to remove fingerprints or other traces from handling.

Relative intensity of CX11645_LAURA-SS-RE

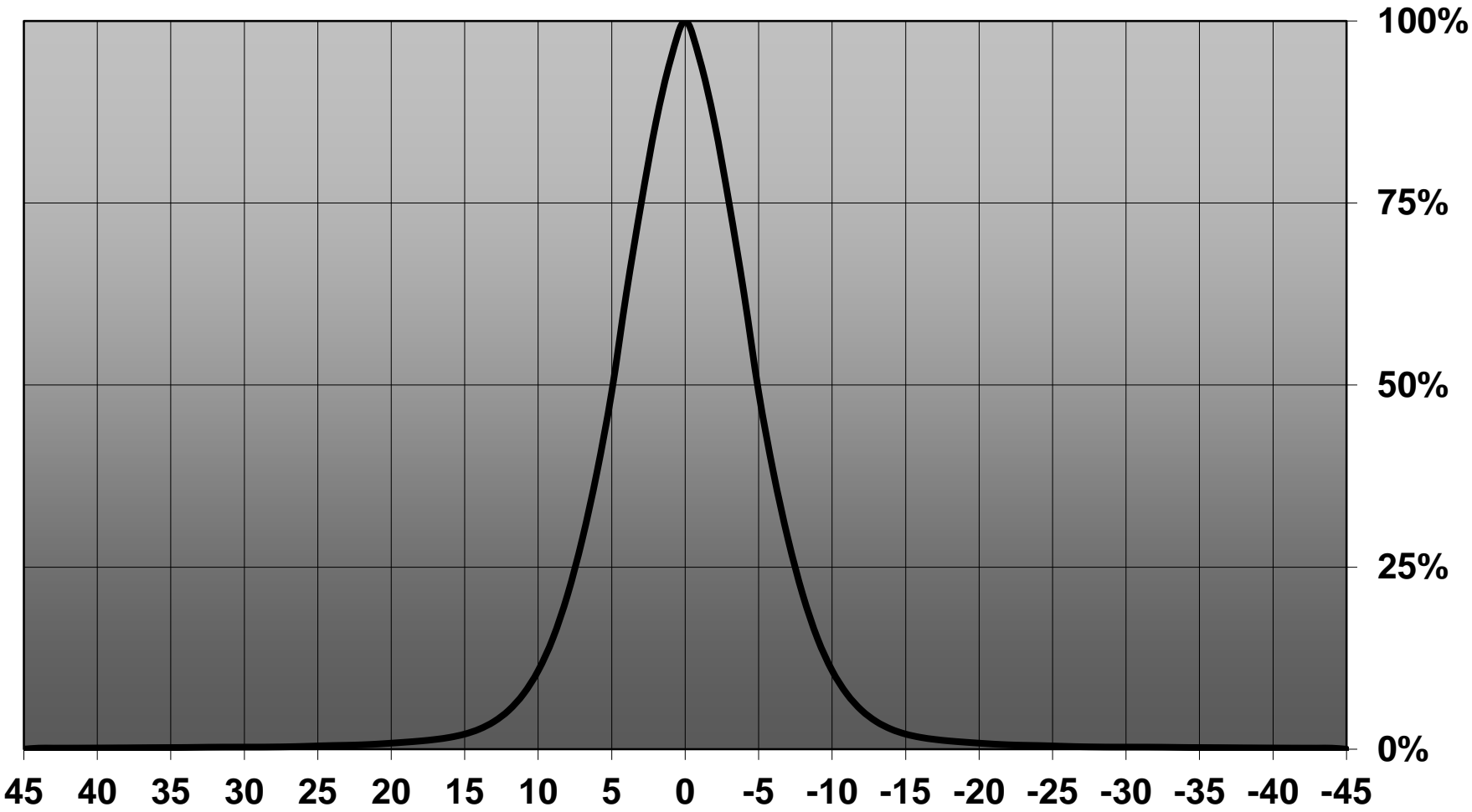

D

C

B

A

4

4

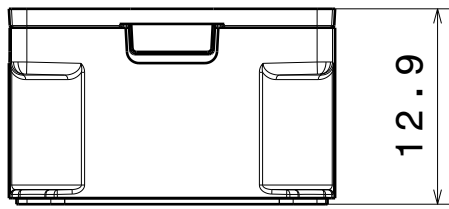

Front View

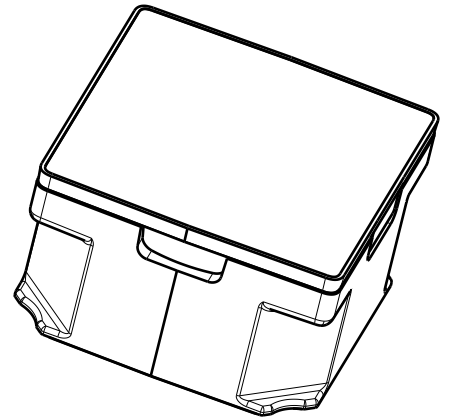

Isometric view

Oval Beam Direction

3

3

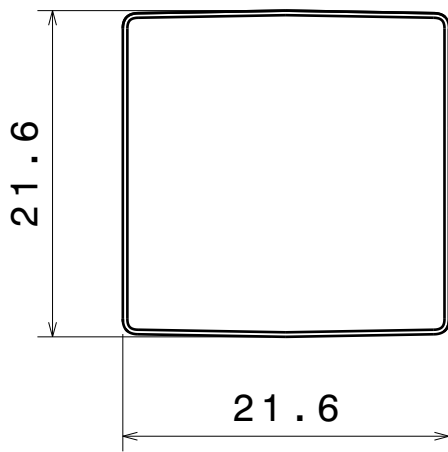

Top view

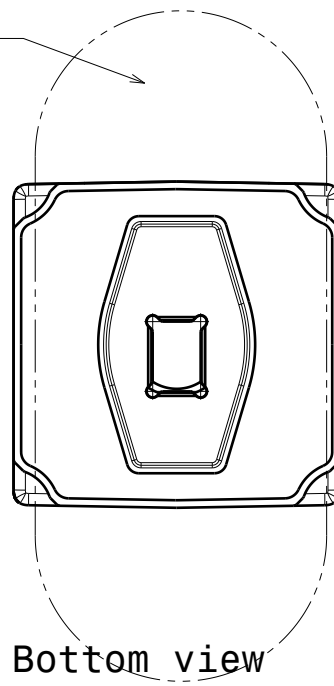

Bottom view

2

2

This drawing is our property.
It can't be reproduced
or communicated without
our written agreement.



Ledil Oy
Salorankatu 10
FIN 24240 SALO
Finland

DRAWING TITLE Mechanical Drawing

DRAWN BY

DATE

ks

08.11.2012

LAURA-RE

CHECKED BY

DATE

as

-

SIZE

PART NUMBER

A4

REV

001

DESIGNED BY

DATE

-

-

SCALE

2:1

WEIGHT

SHEET

1/1

1

1

D

A

Luminaire: Ledil Oy CA13270_LAURA-SS-WAS_(Rebel) Efficiency=92%
Lamps: 1 x Luxeon Rebel 80lm @ 250mA

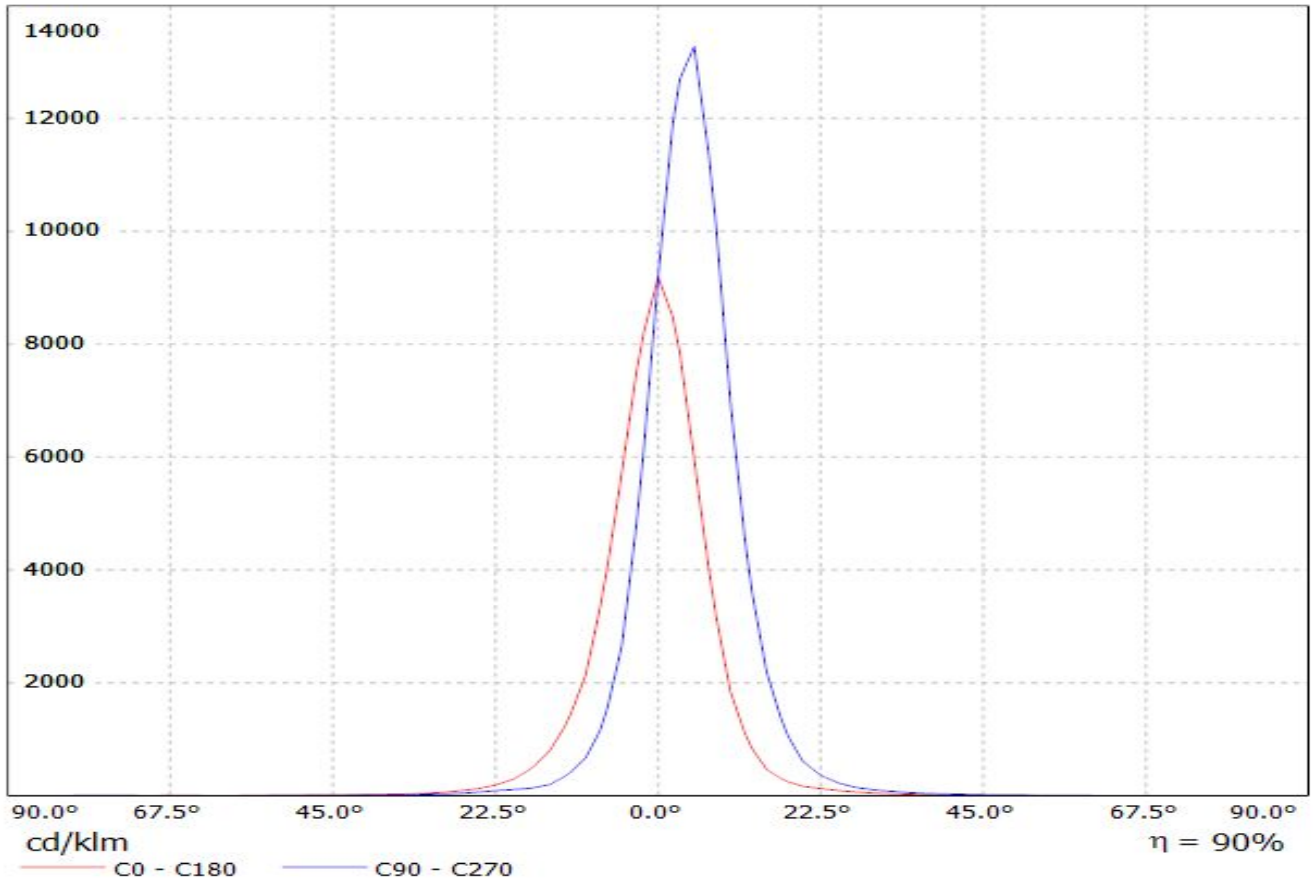

Luminaire: Ledil Oy CA13272_LAURA-O-WAS_(Rebel) Efficiency=87%
Lamps: 1 x Luxeon Rebel 80lm @ 250mA

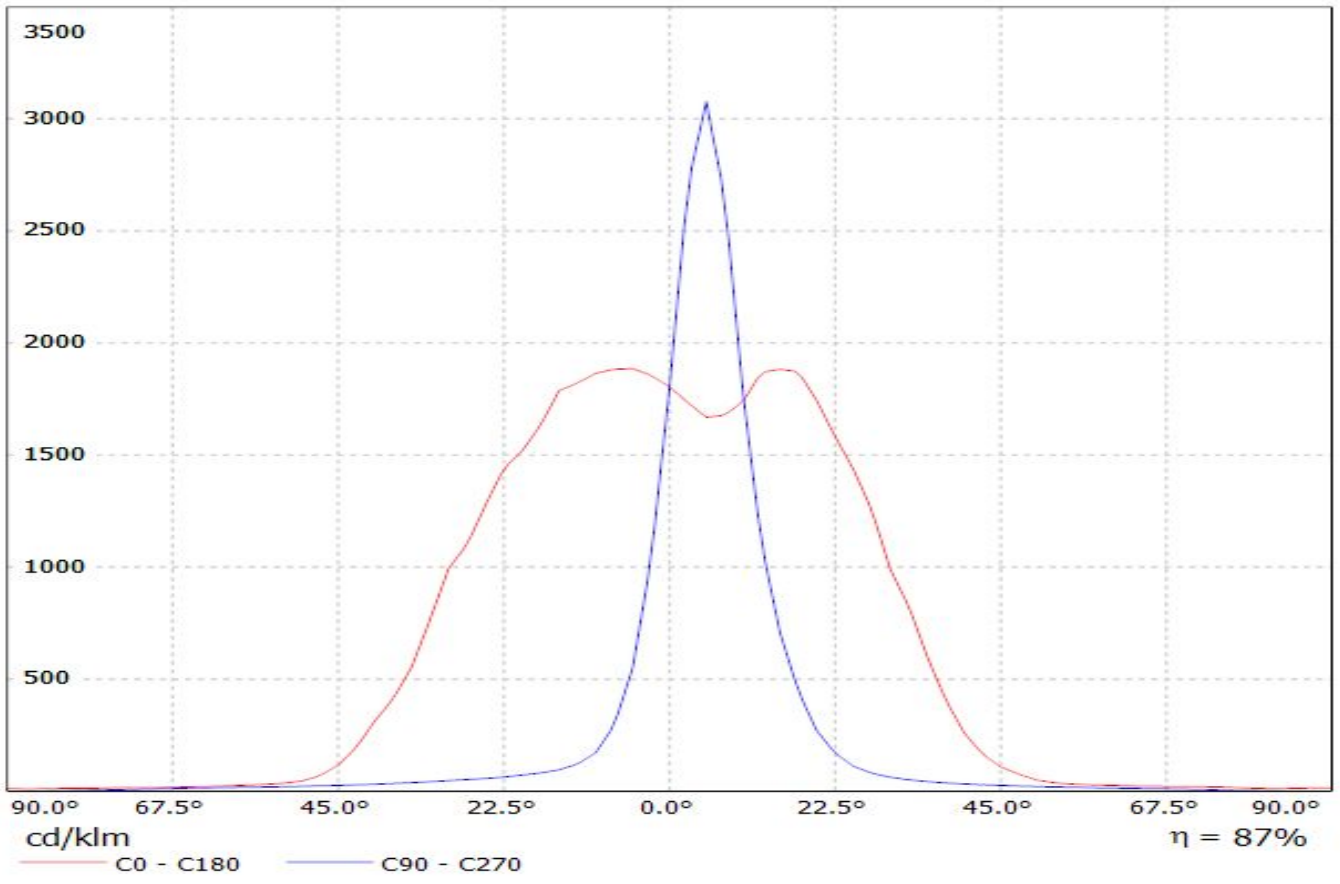

Luminaire: Ledil Oy CP13308_LAURA-O-WAS (Luxeon Rebel 80lm @ 250mA) Efficiency=87%
Lamps: 1 x Luxeon Rebel 80lm @ 250mA

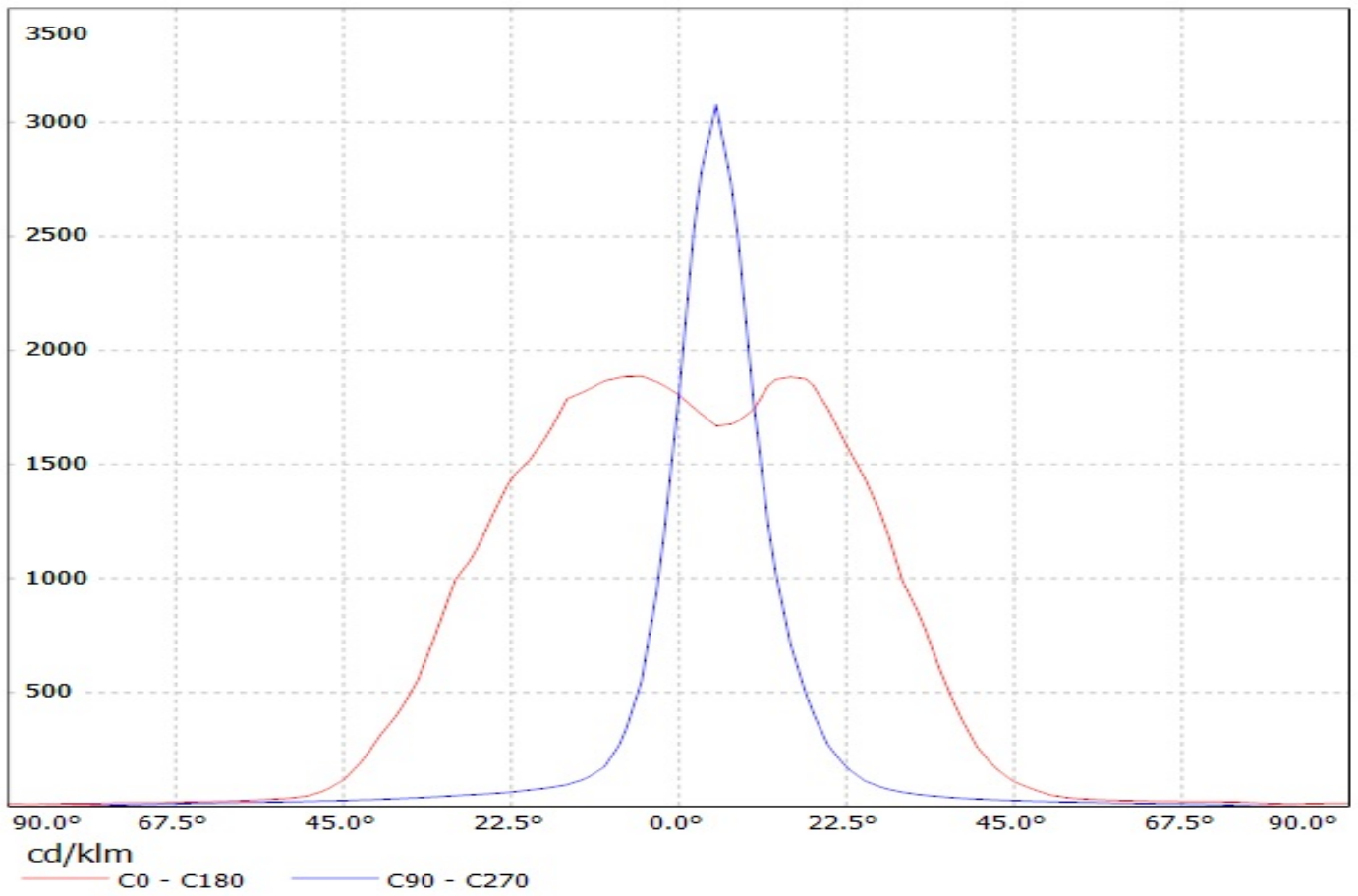

Luminaire: Ledil Oy CP13308_LAURA-O-WAS (Luxeon Rebel 80lm @ 250mA) Efficiency=87%
Lamps: 1 x Luxeon Rebel 80lm @ 250mA

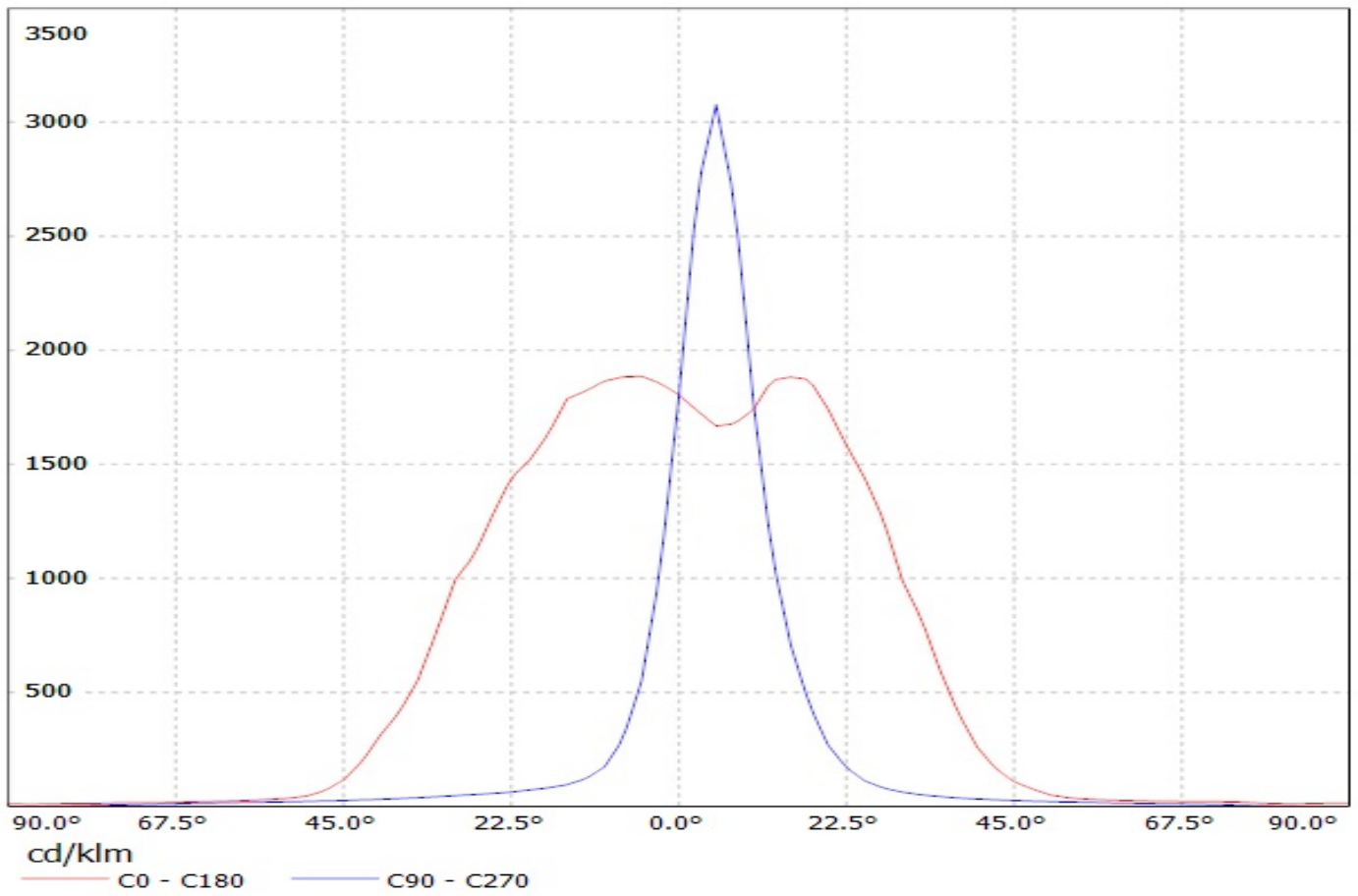

Luminaire: Ledil Oy CP13311_LAURA-SS-WAS (Luxeon Rebel 80lm @ 250mA) Efficiency=92%
Lamps: 1 x Luxeon Rebel 80lm @ 250mA

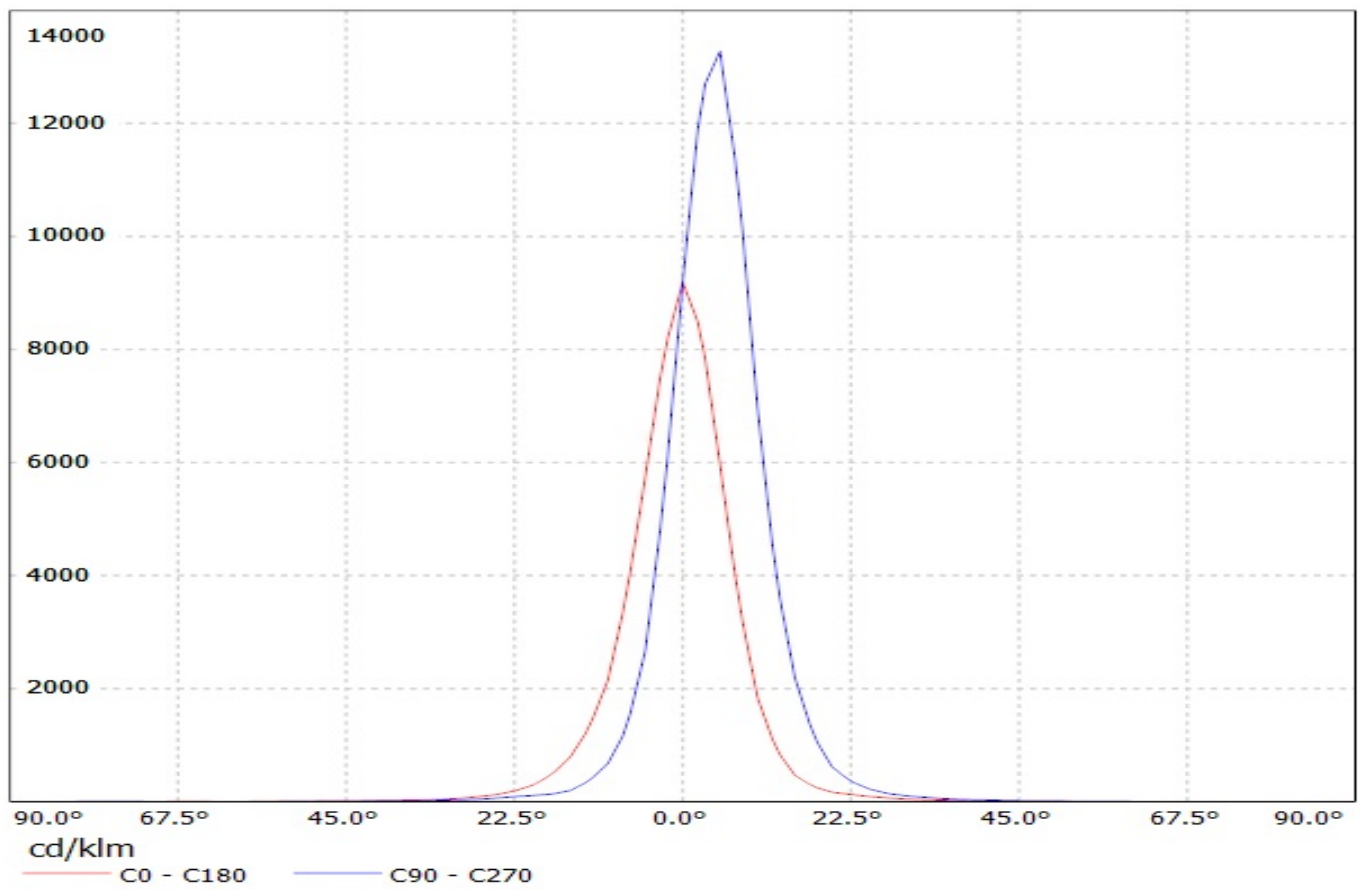

Luminaire: Ledil Oy CP13311_LAURA-SS-WAS (Luxeon Rebel 80lm @ 250mA) Efficiency=92%
Lamps: 1 x Luxeon Rebel 80lm @ 250mA

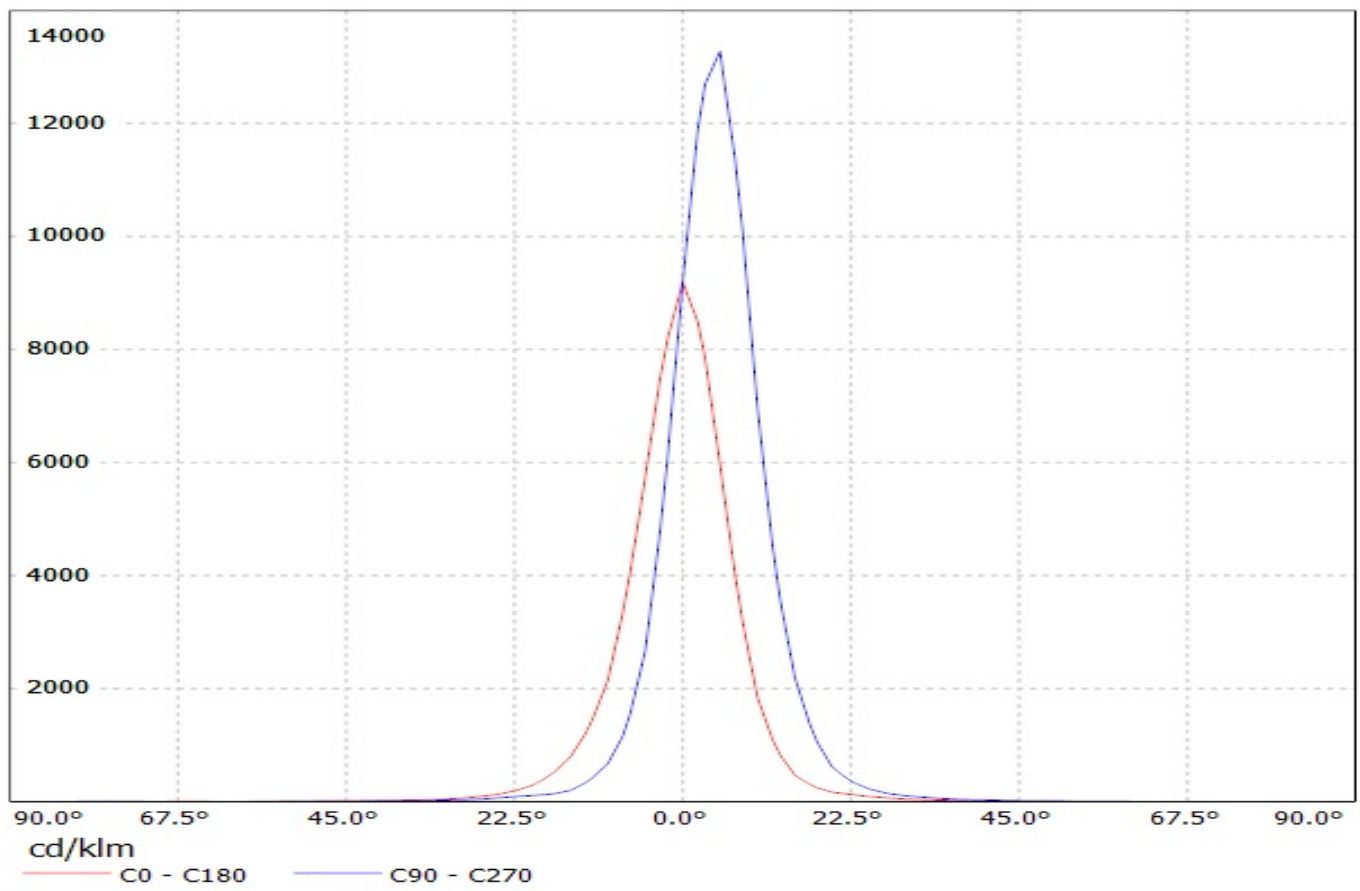

Luminaire: Ledil Oy CX12568_Laura-W (Luxeon Rebel 82lm @ 250mA) Efficiency=88%
Lamps: 1 x Luxeon Rebel 82lm @ 250mA

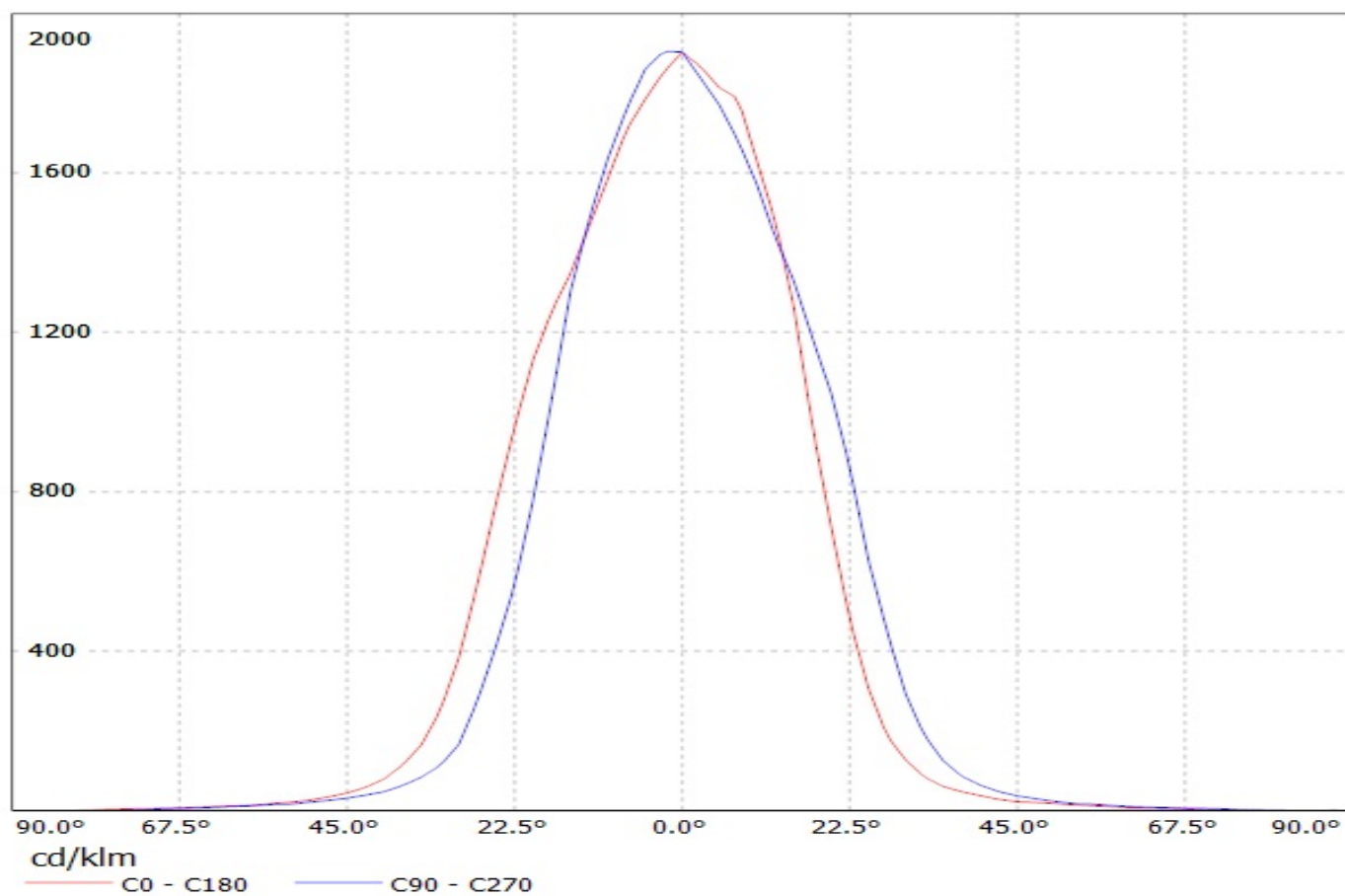

Luminaire: Ledil Oy CA13270_LAURA-SS-WAS_(Rebel) Efficiency=92%

Lamps: 1 x Luxeon Rebel 80lm @ 250mA

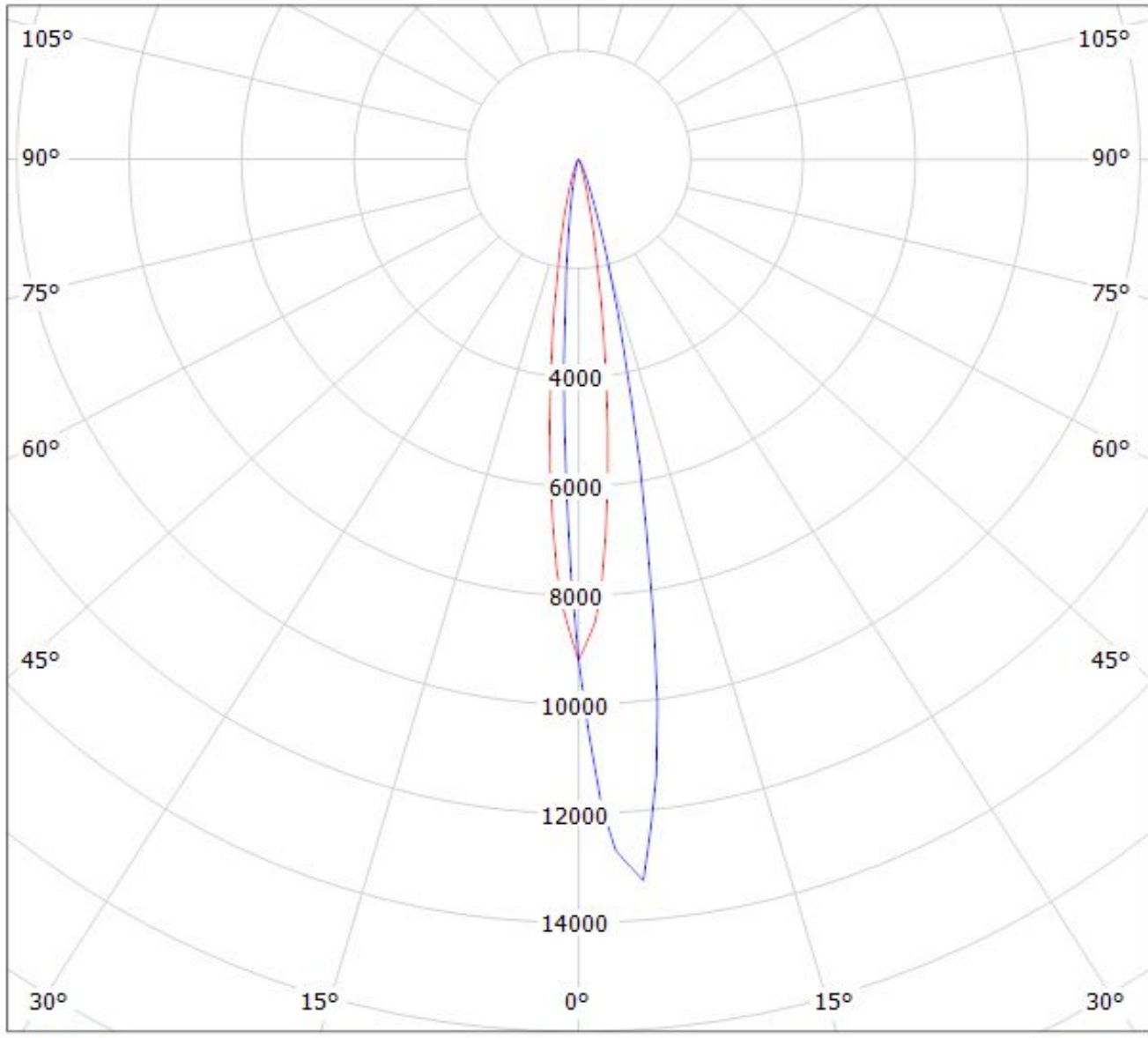

cd/klm

— C0 - C180

— C90 - C270

η = 90%

Luminaire: Ledil Oy CA13272_LAURA-O-WAS_(Rebel) Efficiency=87%
Lamps: 1 x Luxeon Rebel 80lm @ 250mA

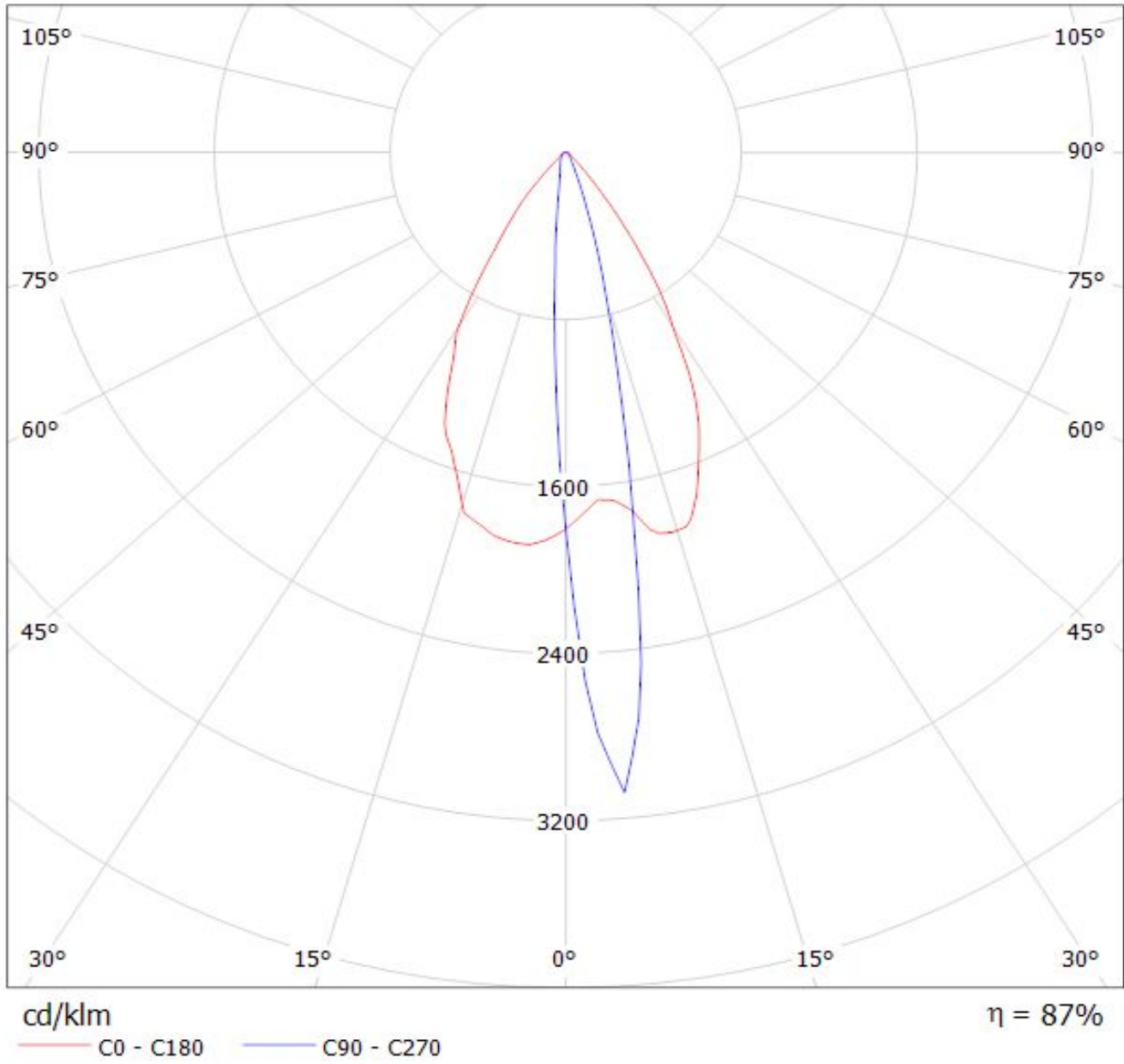

Luminaire: Ledil Oy CP13308_LAURA-O-WAS (Luxeon Rebel 80lm @ 250mA) Efficiency=87%
Lamps: 1 x Luxeon Rebel 80lm @ 250mA

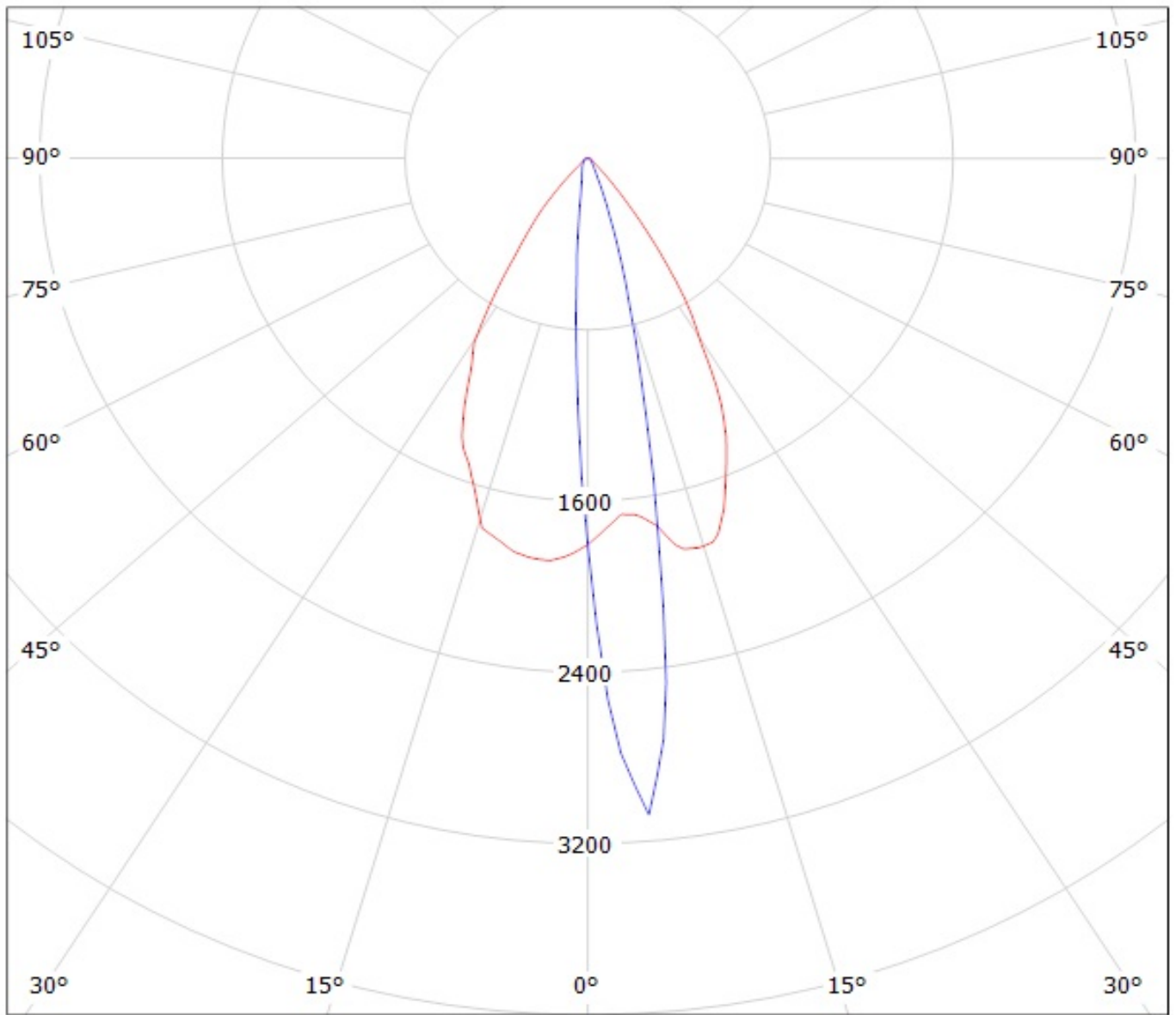

cd/klm
— C0 - C180 — C90 - C270

Luminaire: Ledil Oy CP13308_LAURA-O-WAS (Luxeon Rebel 80lm @ 250mA) Efficiency=87%
Lamps: 1 x Luxeon Rebel 80lm @ 250mA

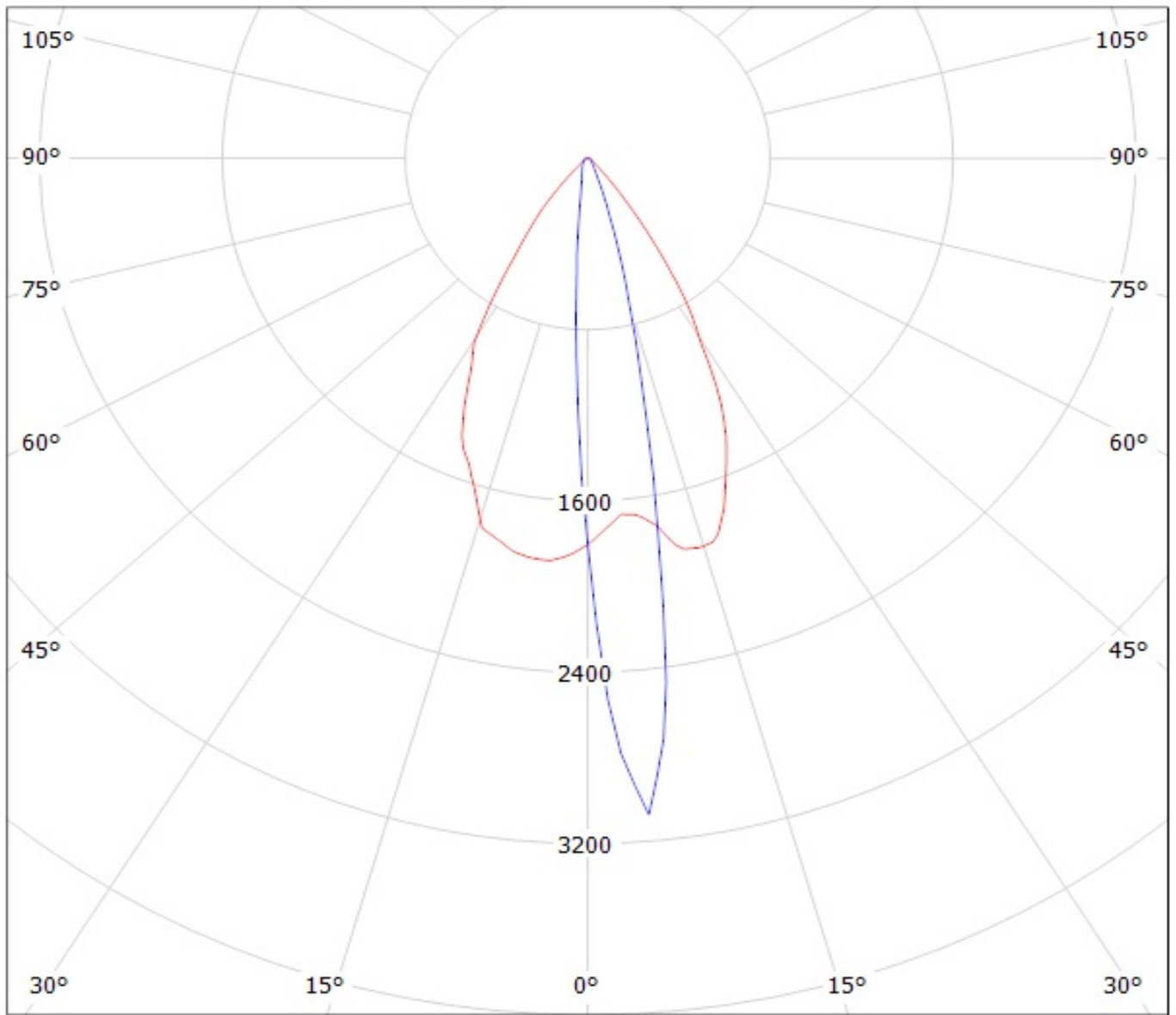

cd/klm
— C0 - C180 — C90 - C270

Luminaire: Ledil Oy CP13311_LAURA-SS-WAS (Luxeon Rebel 80lm @ 250mA) Efficiency=92%
Lamps: 1 x Luxeon Rebel 80lm @ 250mA

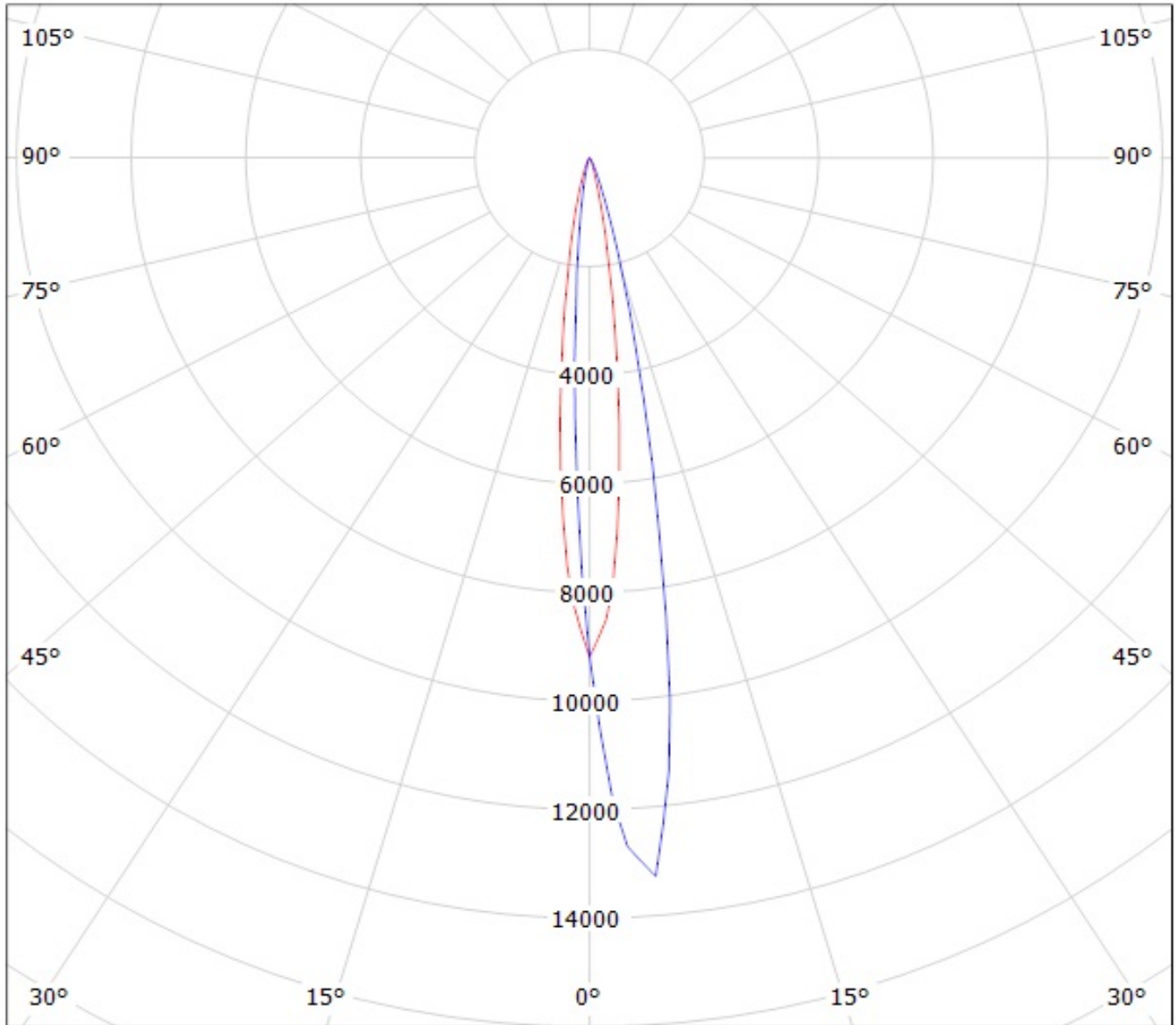

cd/klm

— C0 - C180

— C90 - C270

Luminaire: Ledil Oy CP13311_LAURA-SS-WAS (Luxeon Rebel 80lm @ 250mA) Efficiency=92%
Lamps: 1 x Luxeon Rebel 80lm @ 250mA

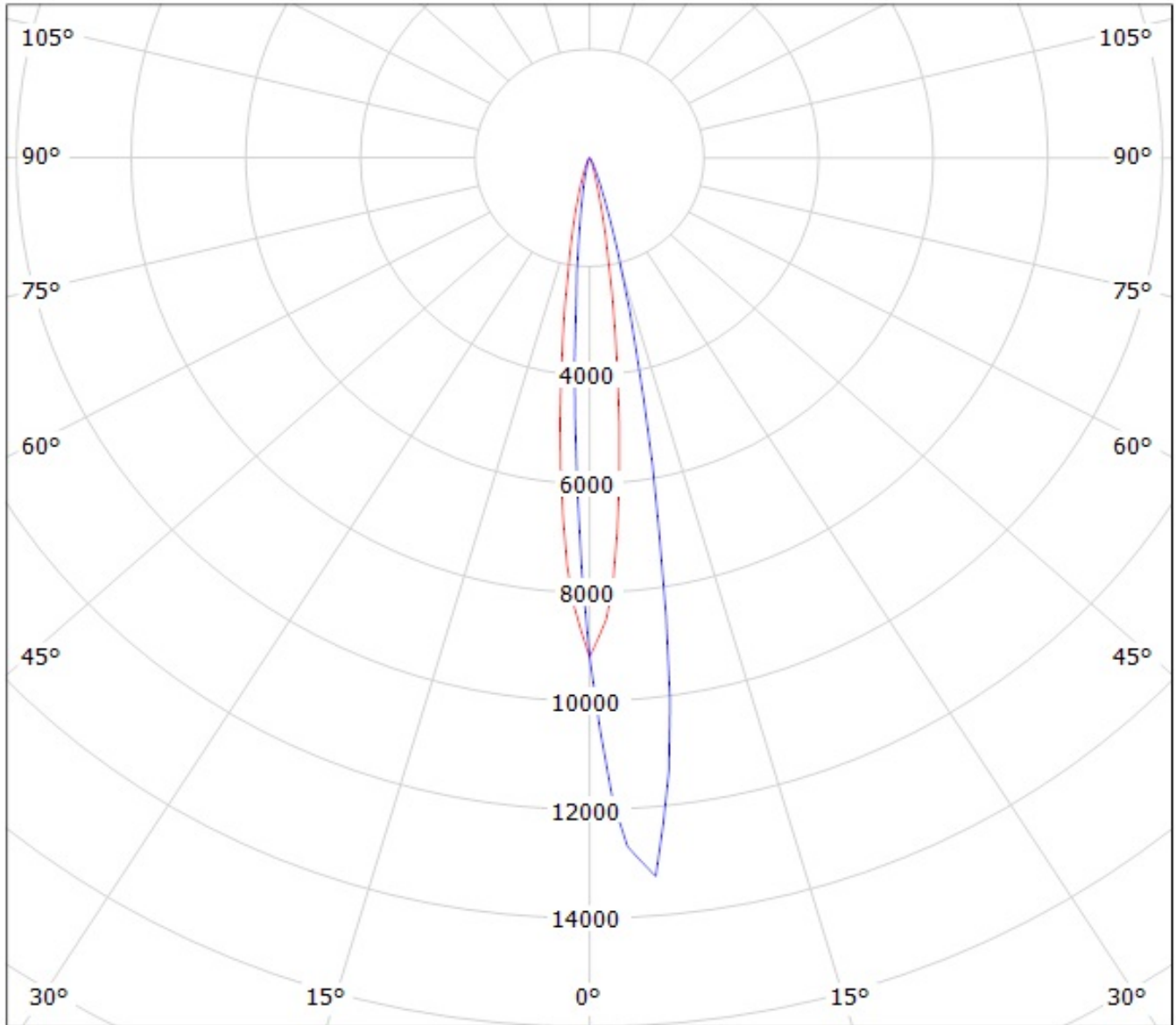

cd/klm

— C0 - C180

— C90 - C270

Luminaire: Ledil Oy CX12568_Laura-W (Luxeon Rebel 82lm @ 250mA) Efficiency=88%
Lamps: 1 x Luxeon Rebel 82lm @ 250mA

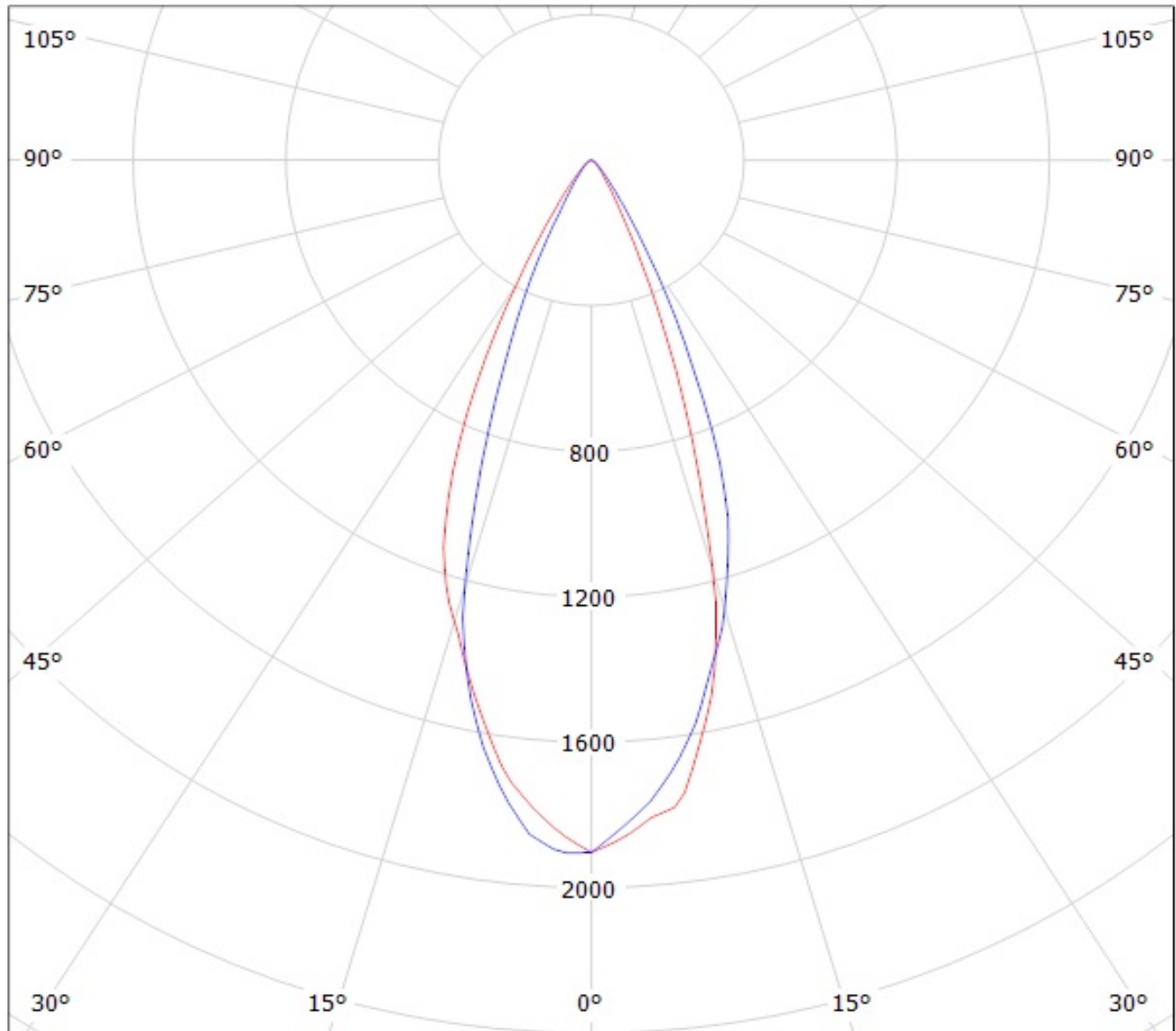

cd/klm

— C0 - C180

— C90 - C270