



SANYO Semiconductors

DATA SHEET

An ON Semiconductor Company

LV8747T — Bi-CMOS LSI PWM Constant-Current Control Stepping Motor Driver and Switching Regulator Controller

Overview

The LV8747T is a PWM constant-current control stepping motor driver and switching regulator controller IC.

Features

- Two circuits of PWM constant-current control stepping motor driver incorporated
- Two circuits of switching regulator controller incorporated
- Motor driver control power incorporated
- Control of the stepping motor to W1-2 phase excitation possible
- Chopping frequency selectable
- Output short-circuit protection circuit incorporated
- High-precision reference voltage circuit incorporated
- Output-stage push-pull composition enabling high-speed operation
- Timer latch type short-circuit protection circuit incorporated
- Upper and lower regenerative diodes incorporated
- Thermal shutdown circuit incorporated

Specifications

Absolute Maximum Ratings at $T_a = 25^\circ\text{C}$

Parameter	Symbol	Conditions	Ratings	Unit
Supply voltage	VM max		38	V
Driver output peak current 1	MDI _O peak1	OUT1/OUT2 $t_w \leq 10\text{ms}$, duty 20%	1.75	A
Driver output continuous current 1	MDI _O max1	OUT1/OUT2	1.5	A
Driver output peak current 2	MDI _O peak2	OUT3/OUT4 $t_w \leq 10\text{ms}$, duty 20%	0.8	A
Driver output continuous current 2	MDI _O max2	OUT3/OUT4	0.5	A
Regulator output current	SWI _O max	OUT5/OUT6 $t_w \leq 1\mu\text{s}$	500	mA

Continued on next page.

■ Any and all SANYO Semiconductor Co.,Ltd. products described or contained herein are, with regard to "standard application", intended for the use as general electronics equipment (home appliances, AV equipment, communication device, office equipment, industrial equipment etc.). The products mentioned herein shall not be intended for use for any "special application" (medical equipment whose purpose is to sustain life, aerospace instrument, nuclear control device, burning appliances, transportation machine, traffic signal system, safety equipment etc.) that shall require extremely high level of reliability and can directly threaten human lives in case of failure or malfunction of the product or may cause harm to human bodies, nor shall they grant any guarantee thereof. If you should intend to use our products for applications outside the standard applications of our customer who is considering such use and/or outside the scope of our intended standard applications, please consult with us prior to the intended use. If there is no consultation or inquiry before the intended use, our customer shall be solely responsible for the use.

■ Specifications of any and all SANYO Semiconductor Co.,Ltd. products described or contained herein stipulate the performance, characteristics, and functions of the described products in the independent state, and are not guarantees of the performance, characteristics, and functions of the described products as mounted in the customer's products or equipment. To verify symptoms and states that cannot be evaluated in an independent device, the customer should always evaluate and test devices mounted in the customer's products or equipment.

SANYO Semiconductor Co., Ltd.

<http://semicon.sanyo.com/en/network>

LV8747T

Continued from preceding page.

Parameter	Symbol	Conditions	Ratings	Unit
Allowable power dissipation 1	Pd max1	Independent IC	0.4	W
Allowable power dissipation 2	Pd max2	Our recommended four-layer substrate *1, *2	4.85	W
Operating temperature	Topr		-20 to +85	°C
Storage temperature	Tstg		-55 to +150	°C

*1 Specified circuit board : 100×100×1.6mm³ : 4-layer glass epoxy printed circuit board

*2 For mounting to the backside by soldering, see the precautions.

Allowable Operating Ratings at Ta = 25°C

Parameter	Symbol	Conditions	Ratings	Unit
Supply voltage	VM		10 to 35	V
Logic input voltage	V _{IN}		0 to 5	V
VREF input voltage	VREF		0 to 3	V
Regulator output voltage	V _O		VM-5 to VM	V
Regulator output current	I _O		0 to 200	mA
Error amplifier input voltage	V _{OA}		0 to 3	V
Timing capacity	CT		100 to 15000	pF
Timing resistance	RT		5 to 50	kΩ
Triangular wave oscillation frequency	F _{OSC}		10 to 800	kHz

Electrical Characteristics at Ta = 25°C, VM = 24V, VREF = 1.5V

Parameter	Symbol	Conditions	Ratings			Unit
			min	typ	max	
General						
VM current drain	IM	PS = "H", no load		6	8	mA
Thermal shutdown temperature	TSD	Design guarantee		180		°C
Thermal hysteresis width	ΔTSD	Design guarantee		40		°C
REG5 output voltage	Vreg5	Ireg5 = -1mA	4.5	5.0	5.5	V
Motor Drivers [Charge pump block]						
Boost voltage	VGH	VM = 24V	28.0	28.7	29.8	V
Rise time	tONG	VG = 10μF		50	100	ms
Oscillation frequency	Fcp	CHOP = 20kΩ	90	120	150	kHz
Output block (OUT1/OUT2)						
Output on resistance	RonU1	I _O = -1.5A, source side		0.5	0.8	Ω
	RonD2	I _O = 1.5A, sink side		0.5	0.8	Ω
Output leak current	I _O leak1	V _O = 35V			50	μA
Diode forward voltage	VD1	ID = -1.5A		1.0	1.3	V
Output block (OUT3/OUT4)						
Output on resistance	RonU2	I _O = -500mA, source side		1.5	1.8	Ω
	RonD2	I _O = 500mA, sink side		1.1	1.4	Ω
Output leak current	I _O leak2	V _O = 35V			50	μA
Diode forward voltage	VD2	ID = -500mA		1.0	1.3	V
Logic input block						
Logic pin input current	I _{INL}	V _{IN} = 0.8V	3	8	15	μA
	I _{INH}	V _{IN} = 5V	30	50	70	μA
Logic high-level input voltage	V _{INH}		2.0			V
Logic low-level input voltage	V _{INL}				0.8	V
Current control block						
VREF input current	IREF	VREF = 1.5V	-0.5			μA
Chopping frequency	Fchop	CHOP = 20kΩ	45	62.5	75	kHz
Threshold voltage of current setting comparator	VHH	VREF = 1.5V, I _O = H, I ₁ = H	0.291	0.300	0.309	V
	VLH	VREF = 1.5V, I _O = L, I ₁ = H	0.191	0.200	0.209	V
	VHL	VREF = 1.5V, I _O = H, I ₁ = L	0.093	0.100	0.107	V

Continued on next page.

LV8747T

Continued from preceding page.

Parameter	Symbol	Conditions	Ratings			Unit
			min	typ	max	
Output short-circuit protection circuit						
Charge current	IOCP	VOCP = 0V	15	20	25	μA
Threshold voltage	VthOCP		0.8	1.0	1.2	V
Switching regulator Controller [Reference voltage block]						
REG25 output voltage	Vreg25	Ireg25 = -1mA	2.475	2.500	2.525	V
Input stability	V _{DLI}	VM = 10 to 35V			10	mV
Load stability	V _{DLO}	Ireg25 = 0 to -3mA			10	mV
Internal regulator block						
REGVM5 output voltage	VregVM5	VregVM5 = 1mA	VM-6.0		VM-5.0	V
Triangular wave oscillator block						
Oscillation frequency	FOSC	RT = 20kΩ, CT = 620pF	72	80	88	kHz
Frequency fluctuation	FDV	VM = 10 to 35V		1	5	%
Current setting pin voltage	VRT	RT = 20kΩ	0.91	0.98	1.05	V
Protective circuit block						
Threshold voltage of comparator	VthFB	FB5, FB6	1.40	1.55	1.70	V
Standby voltage	VstSCP	ISCP = 40μA			100	mV
Source current	ISCP	VSCP = 0V	1.6	2.5	3.4	μA
Threshold voltage	VthSCP		1.65	1.8	1.95	V
Latch voltage	VltSCP	ISCP = 40μA			100	mV
Soft start circuit block						
Source current	ISOFT	VSOFT = 0V	1.3	1.6	1.9	μA
Latch voltage	VltSOFT	ISOFT = 40μA			100	mV
Low-input malfunction preventive circuit block						
Threshold voltage	VUT		8.3	8.7	9.1	V
Hysteresis voltage	VHIS		240	340	440	mV
Error amplifier block						
Input offset voltage	V _I O				6	mV
Input offset current	I _I O				30	nA
Input bias current	I _b				100	nA
OPEN open gain	AV			85		dB
Common-phase input voltage range	VCM	VM = 10 to 35V			3.0	V
Common phase removal ratio	CMRR			80		dB
Max output voltage	V _{OH}		4.5	5.0		V
Min output voltage	V _{OL}			0.2	0.5	V
Output sink current	I _{si}	FB = 2.5V	300	600	1000	μA
Output source current	I _{so}	FB = 2.5V	45	75	105	μA
PWM comparator block						
Input threshold voltage (Fosc = 10kHz)	VT100	Duty cycle = 100%	0.95	1.01	1.07	V
	VT0	Duty cycle = 0%	0.49	0.52	0.55	V
Input bias current	IBDT	DT6 = 0.4V			1	μA
MAX duty cycle 1 (Fosc = 80kHz)	Don1	5ch Internally fixed	94			%
MAX duty cycle 2 (Fosc = 160kHz)	Don2	5ch Internally fixed	92			%
MAX duty cycle 3 (Fosc = 10kHz)	Don3	6ch VREG25 divided by 17kΩ and 8kΩ	56	65	74	%
Output block						
Output ON resistance	RonU3	I _O = -200mA, source side		10	12	Ω
	RonD3	I _O = 200mA, sink side		6	8	Ω
Leak current	ILEAK	V _O = 35V			5	μA

LV8747T

Package Dimensions

unit : mm (typ)

3337

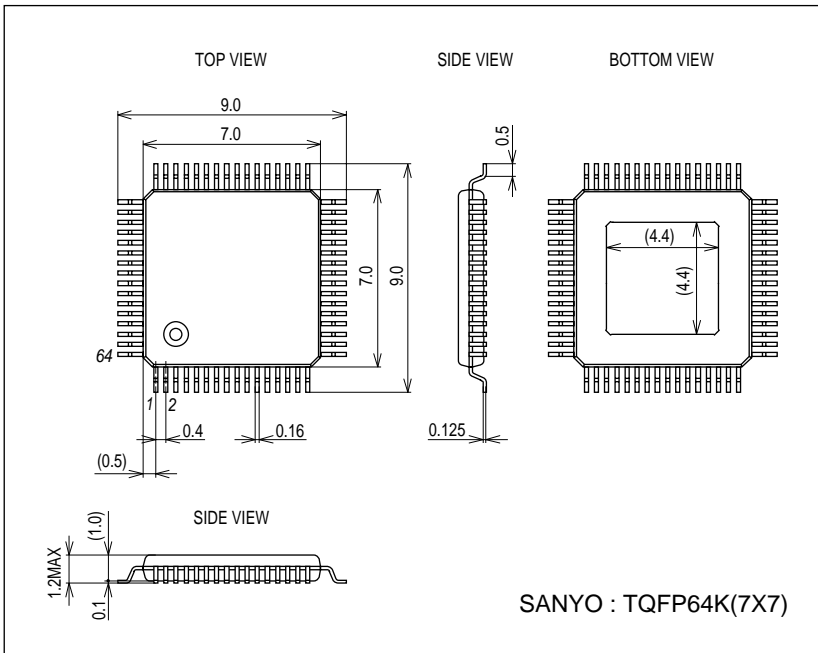

LV8747T

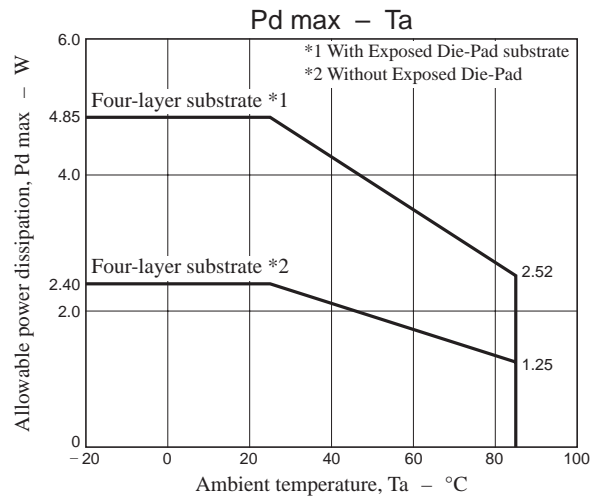

Substrate Specifications (Substrate recommended for operation of LV8747T)

Size : 100mm × 100mm × 1.6mm (four-layer substrate [2S2P])
Material : Glass epoxy
Copper wiring density : L1 = 85% / L4 = 90%

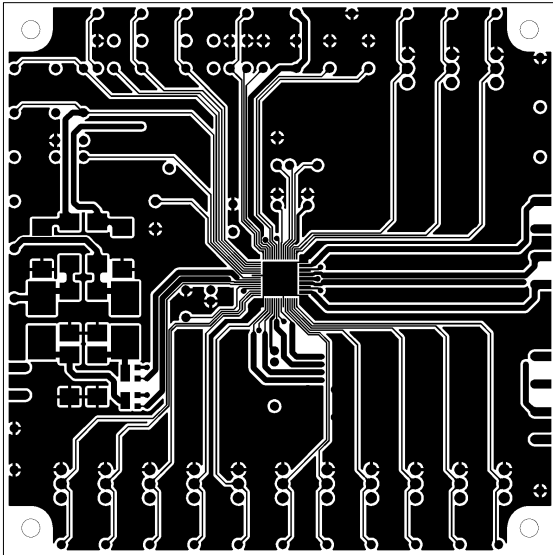

L1 : Copper wiring pattern diagram

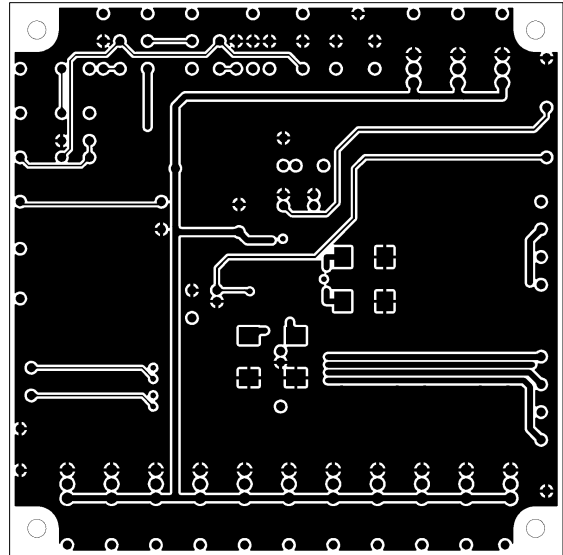

L4 : Copper wiring pattern diagram

Cautions

- 1) The data for the case with the Exposed Die-Pad substrate mounted shows the values when 80% or more of the Exposed Die-Pad is wet.
- 2) For the set design, employ the derating design with sufficient margin.
Stresses to be derated include the voltage, current, junction temperature, power loss, and mechanical stresses such as vibration, impact, and tension.
Accordingly, the design must ensure these stresses to be as low or small as possible.
The guideline for ordinary derating is shown below :
 - (1)Maximum value 80% or less for the voltage rating
 - (2)Maximum value 80% or less for the current rating
 - (3)Maximum value 80% or less for the temperature rating
- 3) After the set design, be sure to verify the design with the actual product.
Confirm the solder joint state and verify also the reliability of solder joint for the Exposed Die-Pad, etc.
Any void or deterioration, if observed in the solder joint of these parts, causes deteriorated thermal conduction, possibly resulting in thermal destruction of IC.

LV8747T

Pin Assignment

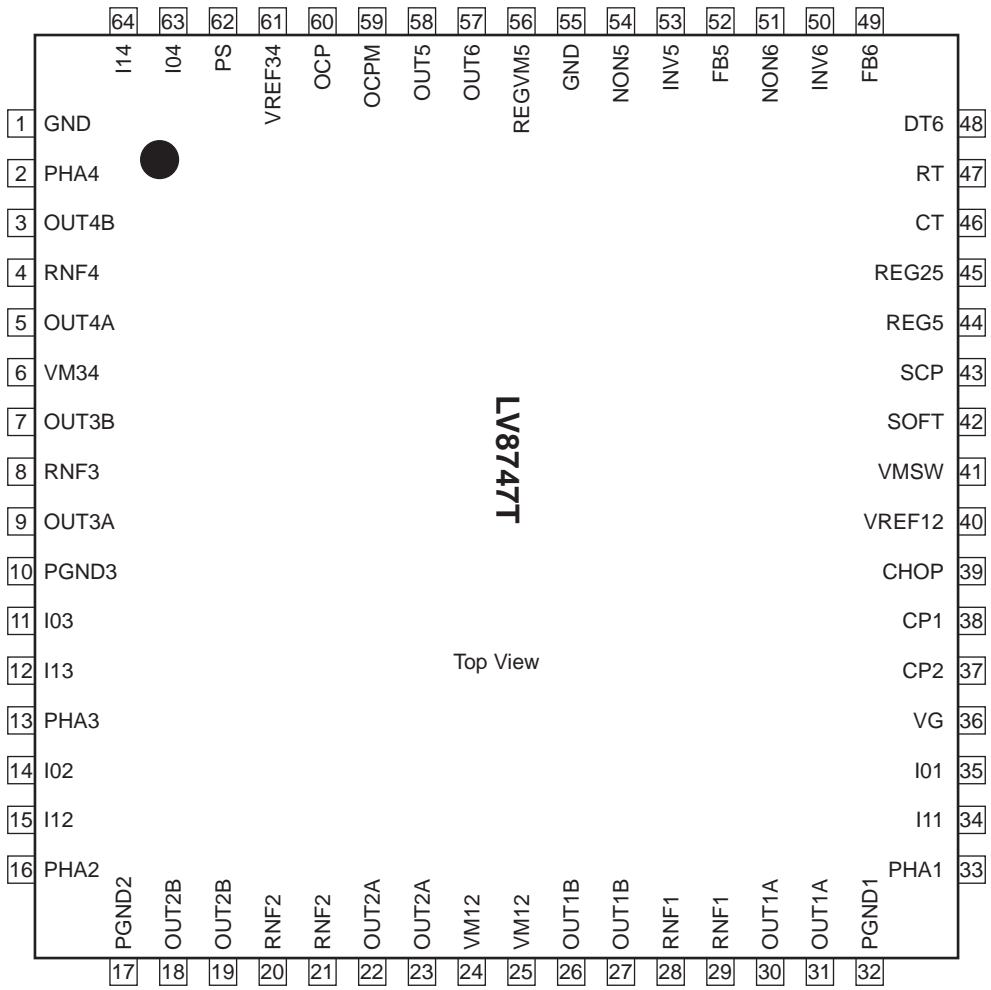

LV8747T

Block Diagram

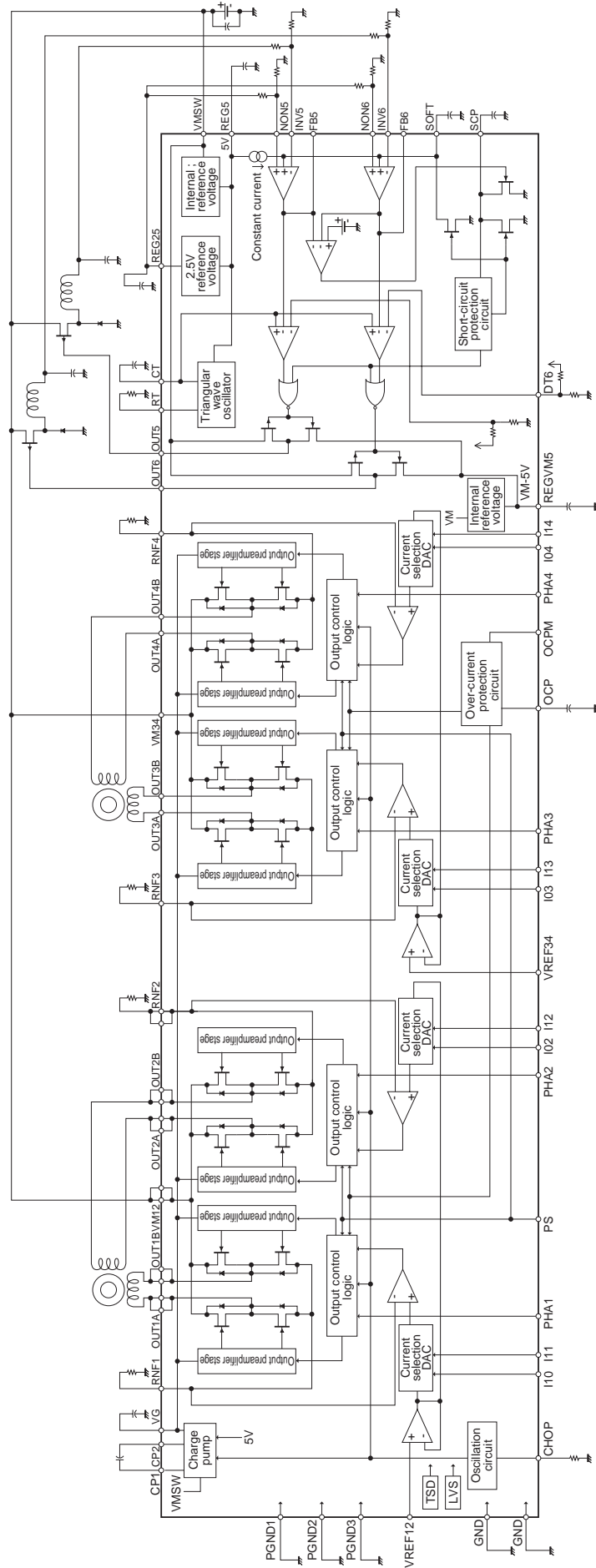

LV8747T

Pin Functions

Pin No	Pin	Description
24	VM12	Driver 1/2ch Pin to connect to power supply
25		
30	OUT1A	Driver 1ch OUTA output pin
31		
26	OUT1B	Driver 1ch OUTB output pin
27		
28	RNF1	Driver 1ch Current sense resistor connection pin
29		
22	OUT2A	Driver 2ch OUTA output pin
23		
18	OUT2B	Driver 2ch OUTB output pin
19		
20	RNF2	Driver 2ch Current sense resistor connection pin
21		
35	I01	Driver 1ch Output current setting input pin
34	I11	
33	PHA1	Driver 1ch Output phase shift input pin
14	I02	Driver 2ch Output current setting input pin
15	I12	
16	PHA2	Driver 2ch Output phase shift input pin
40	VREF12	Driver 1/2ch Output current setting reference voltage input pin
32	PGND1	Driver output Power GND
17	PGND2	Driver output Power GND
6	VM34	Driver 3/4ch Power connection pin
9	OUT3A	Driver 3ch OUTA output pin
7	OUT3B	Driver 3ch OUTB output pin
8	RNF3	Driver 3ch Current sense resistor connection pin
5	OUT4A	Driver 4ch OUTA output pin
3	OUT4B	Driver 4ch OUTB output pin
4	RNF4	Driver 4ch Current sense resistor connection pin
11	I03	Driver 3ch Output current setting input pin
12	I13	
13	PHA3	Driver 3ch Output phase shift input pin
63	I04	Driver 4ch Output current setting input pin
64	I14	
2	PHA4	Driver 4ch Output phase shift input pin
61	VREF34	Driver 3/4ch Output current setting reference voltage input pin
10	PGND3	Driver output Power GND
60	OCP	Pin to connect to the output short-circuit state detection time setting capacitor
59	OCPM	Over-current mode changeover pin
39	CHOP	Pin to connect to the resistor to set the chopping frequency
62	PS	Driver Power save input pin
36	VG	Charge pump capacitor connection pin
38	CP1	Charge pump capacitor connection pin
37	CP2	Charge pump capacitor connection pin
41	VMSW	Power connection pin
44	REG5	Internal regulator output pin
56	REGVM5	Internal regulator output pin
45	REG25	Regulator Reference voltage output pin
46	CT	Regulator Timing capacity external pin
47	RT	Regulator Timing resistor external pin
42	SOFT	Regulator Soft start setting pin
43	SCP	Regulator Timer and latch setting pin
54	NON5	Regulator Error amplifier 5 input + pin

Continued on next page.

LV8747T

Continued from preceding page.

Pin No	Pin	Description
53	INV5	Regulator Error amplifier 5 input – pin
52	FB5	Regulator Error amplifier 5 output pin
58	OUT5	Regulator Output 5
51	NON6	Regulator Error amplifier 6 input + pin
50	INV6	Regulator Error amplifier 6 input – pin
49	FB6	Regulator Error amplifier 6 output pin
57	OUT6	Regulator Output 6
48	DT6	Regulator Output 6 MAX DUTY setting pin
55	GND	GROUND
1	GND	GROUND

LV8747T

Equivalent Circuits

Pin No.	Pin Name	Equivalent Circuit
2 11 12 13 14 15 16 33 34 35 59 62 63 64	PHA4 I03 I13 PHA3 I02 I12 PHA2 PHA1 I11 I01 OCPM PS I04 I14	
36 37 38	VG CP2 CP1	
3 4 5 6 7 8 9 10	OUT4B RNF4 OUT4A VM34 OUT3B RNF3 OUT3A PGND3	
17 18 19 20 21 22 23 24 25 26 27 28 29 30 31 32	PGND2 OUT2B OUT2B RNF2 RNF2 OUT2A OUT2A VM12 VM12 OUT1B OUT1B RNF1 RNF1 OUT1A OUT1A PGND1	

Continued on next page.

LV8747T

Continued from preceding page.

Pin No.	Pin Name	Equivalent Circuit
40 61	VREF12 VREF34	<p style="text-align: center;">Equivalent Circuit</p>
39	CHOP	
60	OCP	
44	REG5	
45	REG25	

Continued on next page.

LV8747T

Continued from preceding page.

Pin No.	Pin Name	Equivalent Circuit
49 50 51 52 53 54	FB6 INV6 NON6 FB5 INV5 NON5	
48	DT6	
46 47	CT RT	
57 58	OUT6 OUT5	

Continued on next page.

LV8747T

Continued from preceding page.

Pin No.	Pin Name	Equivalent Circuit
56	REGVM5	
42	SOFT	
43	SCP	

Stepping Motor Driver OUT1/OUT2(OUT3/OUT4)

(1) Output control logic

Parallel input (Note)		Output		Current direction
PS	PHA	OUTA	OUTB	
Low	*	Off	Off	Standby
High	Low	Low	High	OUTB→OUTA
High	High	High	Low	OUTA→OUTB

(Note) : Enter either "H" or "L" externally for the logic input pin. Never use the input pin in the OPEN state.

(2) Constant-current setting

I0 (Note)	I1 (Note)	Output current
High	High	$I_O = (V_{REF}/5) / R_{NF}$
Low	High	$I_O = ((V_{REF}/5) / R_{NF}) \times 2/3$
High	Low	$I_O = ((V_{REF}/5) / R_{NF}) \times 1/3$
Low	Low	$I_O = 0$

(Note) : Enter either "H" or "L" externally for the logic input pin. Never use the input pin in the OPEN state.

Set current calculation method

The constant-current control setting of STM driver is determined as follows from the setting of VREF voltage, and I0 and I1, and resistor (RNF) connected between RNF and GND :

$$I_{const} [A] = ((V_{REF} [V] / 5) / R_{NF} [\Omega]) \times \text{attenuation factor}$$

(Example) For $V_{REF} = 1.5V$, $I_0 = I_1 = \text{"H"}$ and $R_{NF} = 1\Omega$;

$$I_{const} = 1.5V/5/1\Omega \times 1 = 0.3A$$

(3) Setting the chopping frequency

For constant-current control, chopping operation is made with the frequency determined by the external resistor (connected to the CHOP pin).

The chopping frequency to be set with the resistance connected to the CHOP pin (pin 39) is as shown below.

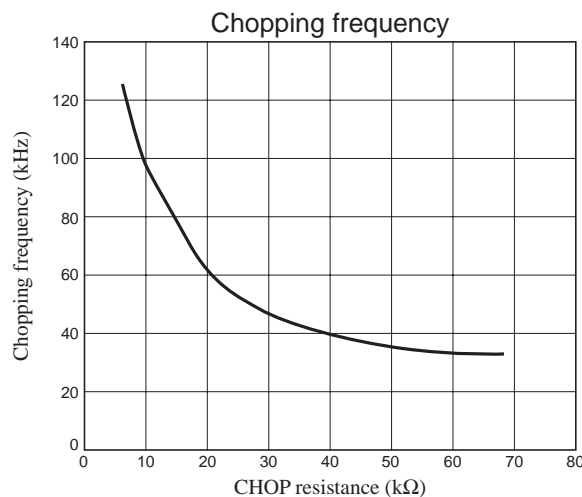

The recommended chopping frequency ranges from 30kHz to 120kHz.

(4) Constant-current control time chart (chopping operation)

(Sine wave increasing direction)

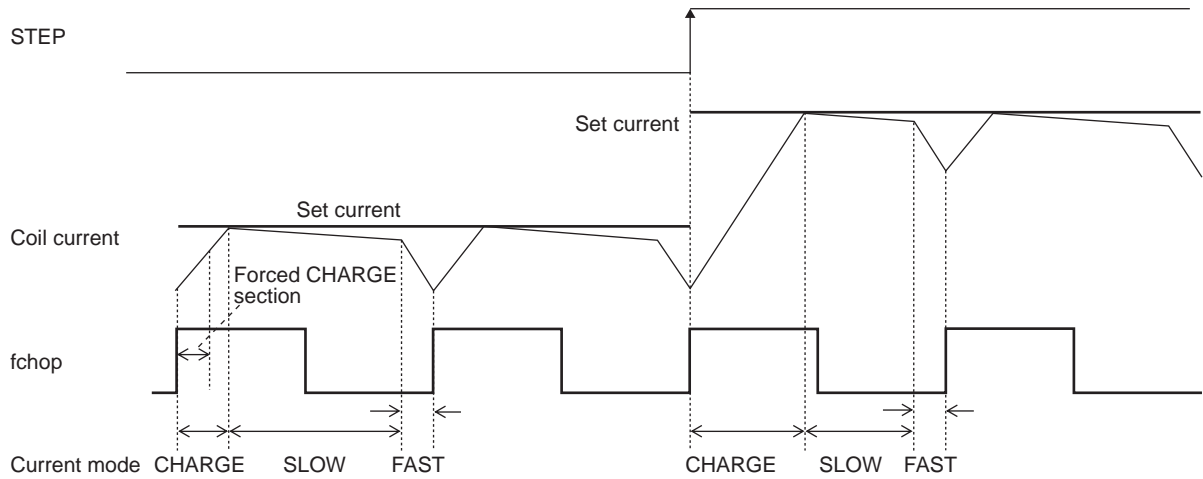

(Sine wave decreasing direction)

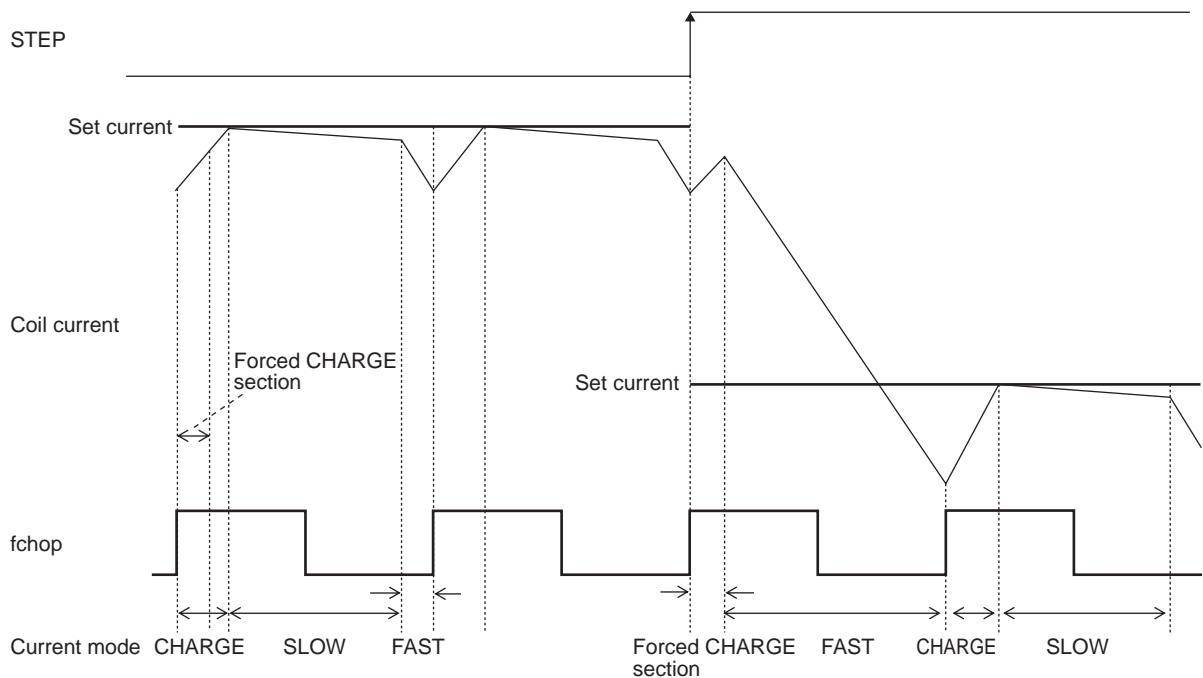

In each current mode, the operation sequence is as described below :

- At rise of chopping frequency, the CHARGE mode begins. (The section in which the CHARGE mode is forced regardless of the magnitude of the coil current (ICOIL) and set current (IREF) exists for 1/16 of one chopping cycle.)
- The coil current (ICOIL) and set current (IREF) are compared in this forced CHARGE section.

When $(ICOIL < IREF)$ state exists in the forced CHARGE section ;

CHARGE mode up to $ICOIL \geq IREF$, then followed by changeover to the SLOW DECAY mode, and finally by the FAST DECAY mode for the 1/16 portion of one chopping cycle.

When $(ICOIL < IREF)$ state does not exist in the forced CHARGE section;

The FAST DECAY mode begins. The coil current is attenuated in the FAST DECAY mode till one cycle of chopping is over.

Above operations are repeated. Normally, the SLOW (+FAST) DECAY mode continues in the sine wave increasing direction, then entering the FAST DECAY mode till the current is attenuated to the set level and followed by the SLOW DECAY mode.

LV8747T

(5) Output current vector locus (one step is normalized to 90 degrees)

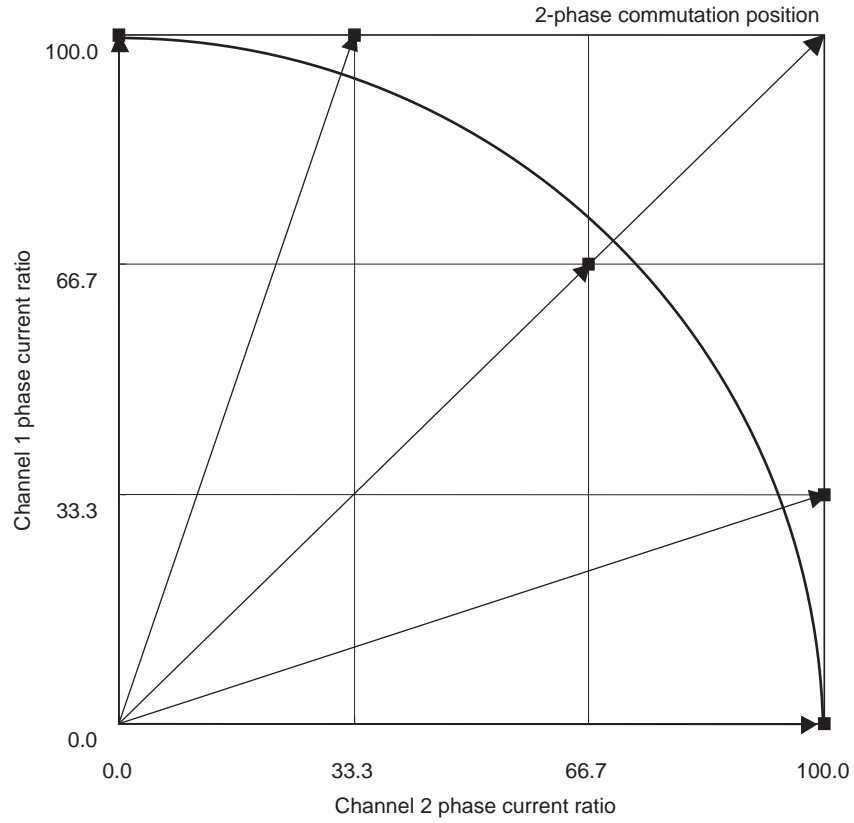

(6) Typical current waveform in each excitation mode
Two-phase excitation (1/2ch, CW mode)

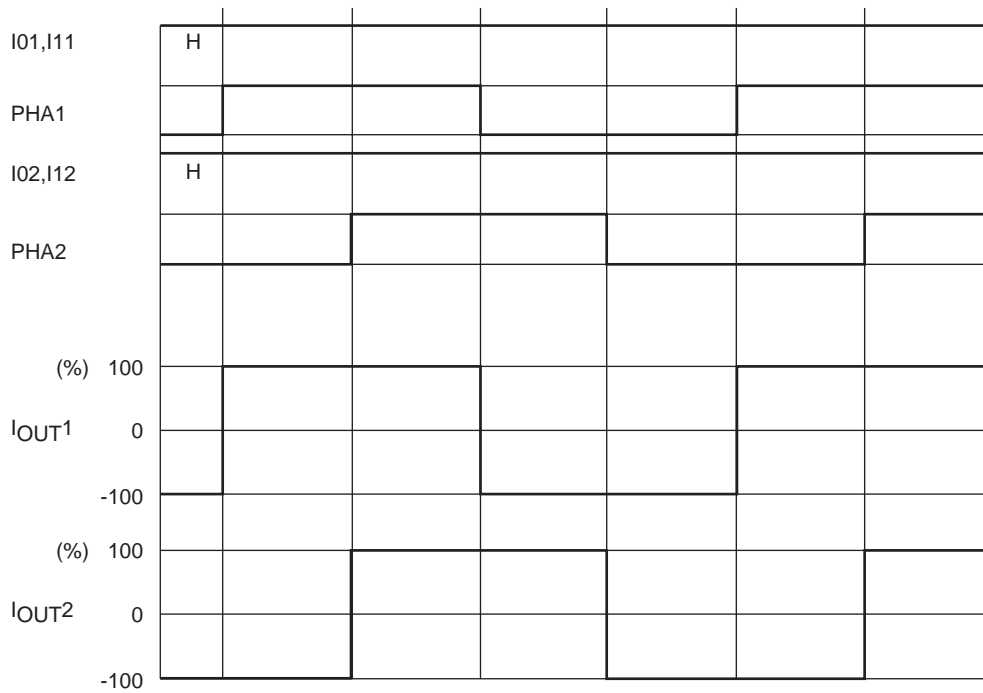

LV8747T

1-2 phase excitation (1/2ch, CW mode)

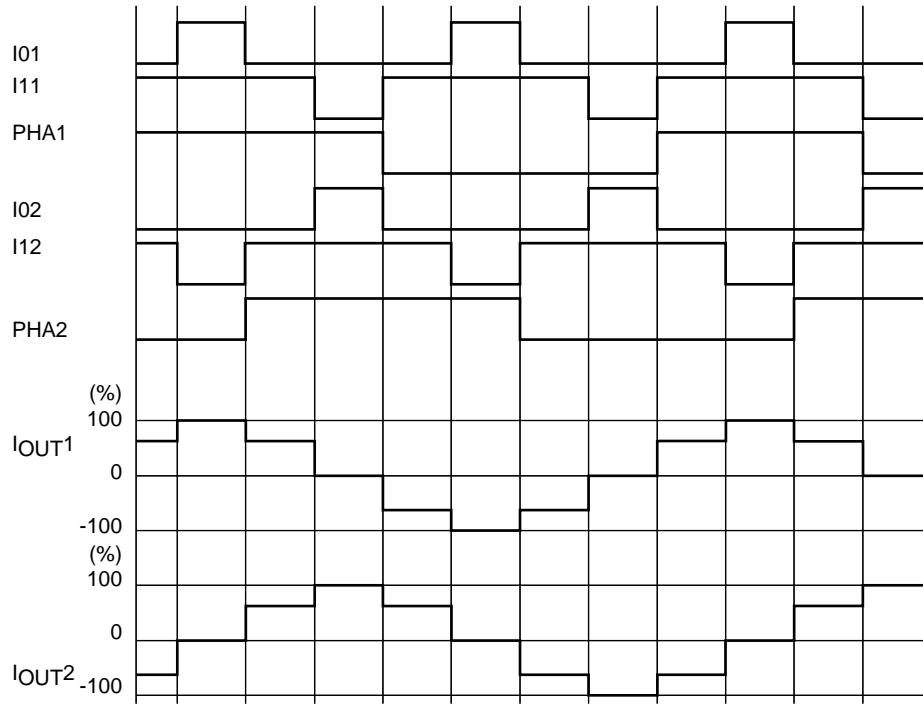

PCA01195

W1-2 phase excitation (1/2ch, CW mode)

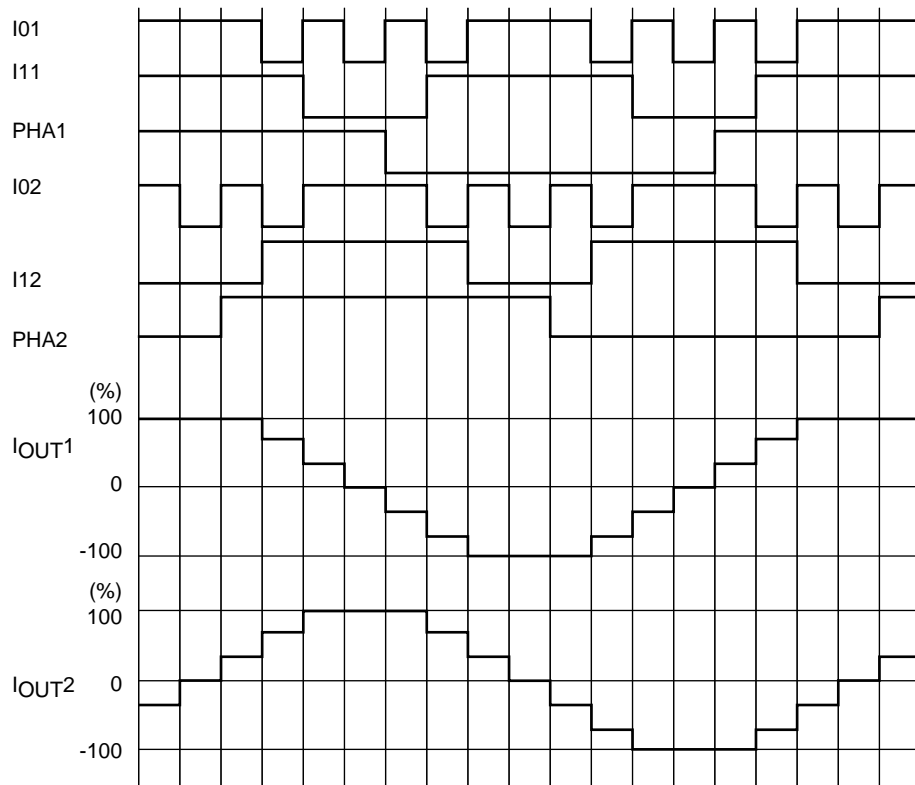

PCA01196

Output short-circuit protection circuit

To protect IC from damage due to short-circuit of the output caused by lightning or ground fault, the output short-circuit protection circuit to put the output in the standby mode is incorporated.

(1) Output short-circuit protection operation changeover function

Changeover to the output short-circuit protection of IC is made by the setting of OCPM pin.

OCPM	State
“Low”	Auto reset method
“High”	Latch method

(Auto reset method)

When the output current is below the output short-circuit protection current, the output is controlled by the input signal. When the output current exceeds the detection current, the switching waveform as shown below appears instead.

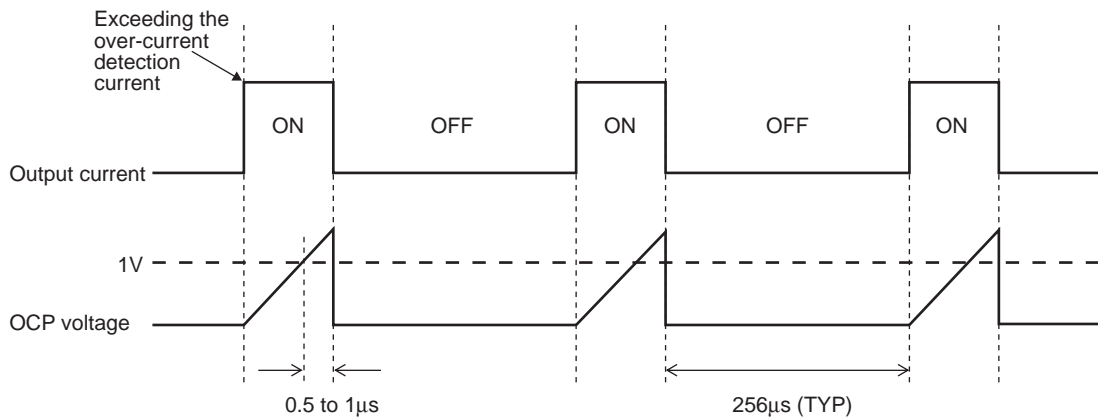

When detecting the output short-circuit state, the short-circuit detection circuit is activated.

When the short-circuit detection circuit operation exceeds the timer latch time described later, the output is changed over to the standby mode and reset to the ON mode again in 256µs (TYP). In this event, if the over-current mode still continues, the above switching mode is repeated till the over-current mode is canceled.

(Latch method)

Similarly to the case of automatic reset method, the short-circuit detection circuit is activated when it detects the output short-circuit state.

When the short-circuit detection circuit operation exceeds the timer latch time described later, the output is changed over to the standby mode.

In this method, latch is released by setting PS = “L”

(2) OCP pin constant setting method (timer latch setting)

Connect C between the OCP pin and GND, and the time up to the output OFF can be set in case of output short-circuit. The C value can be determined as follows :

Timer latch : T_{ocp}

$$T_{ocp} \approx C \times V/I [s]$$

V : Threshold voltage TYP 1V

I : OCP charge current TYP 20µA

(C: Recommended constant value 100pF to 200pF)

LV8747T

Switching Regulator Controller

(1) Regulator block diagram

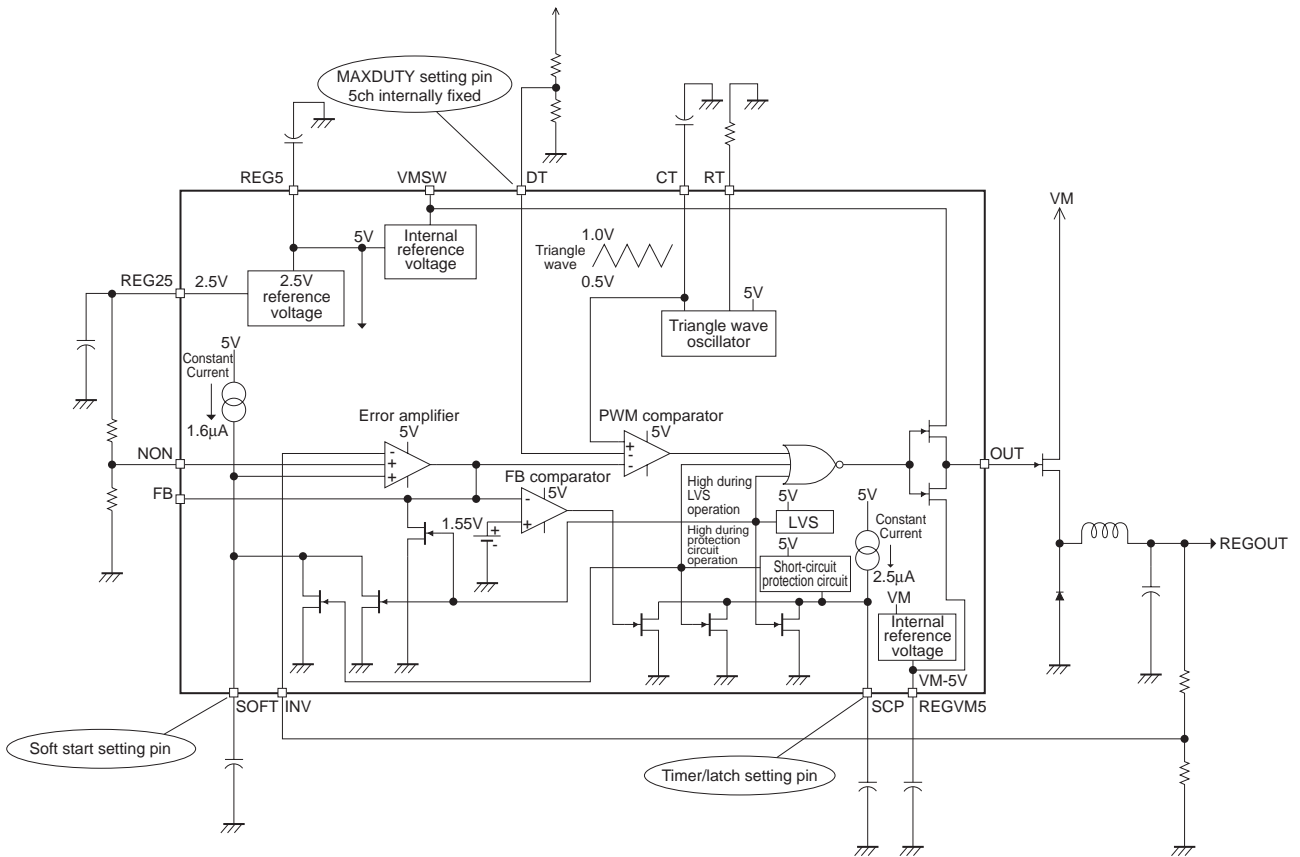

(2) Timing chart

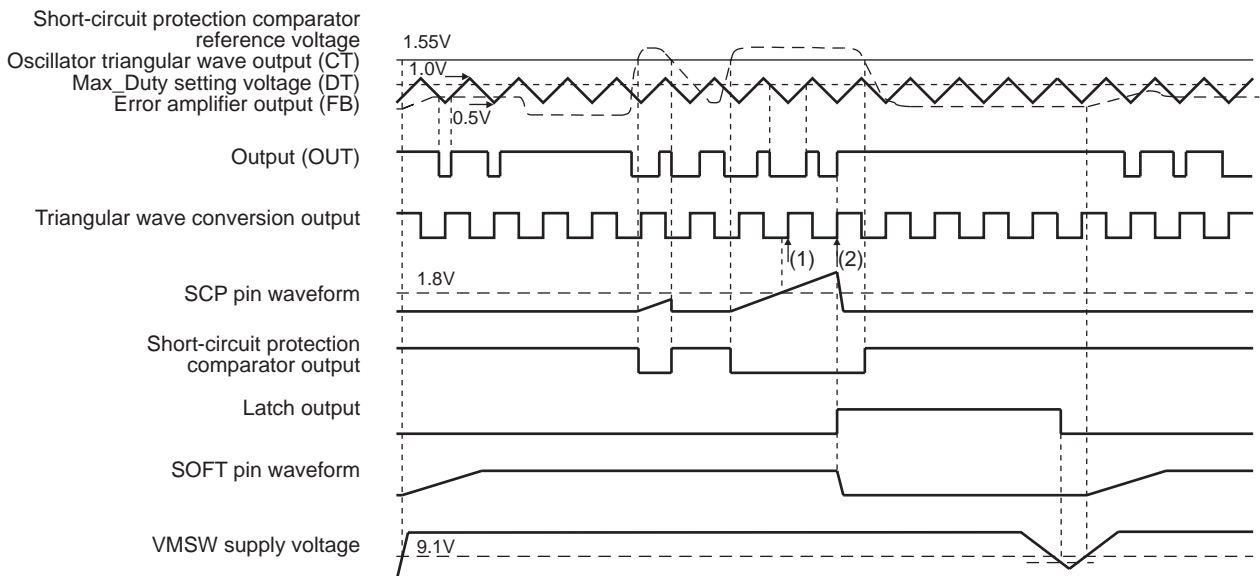

(3) SOFT pin constant setting method (Soft start setting)

The switching regulator can be set to soft-start by connecting C between the SOFT pin and GND.
Determine the C value as follows :

$$\begin{aligned} \text{Soft start time : } T_{\text{soft}} & \quad T_{\text{soft}} \approx C \times V/I \text{ [s]} \\ & \quad V : \text{Error amplifier input + pin voltage (NON5/NON6)} \\ & \quad I : \text{SOFT charge current TYP } 1.6\mu\text{A} \end{aligned}$$

(4) SCP pin constant setting method (Timer latch setting)

The time up to the output OFF in case of regulator output short-circuit can be set by connecting C between the SCP pin and GND.

Determine the C value as follows :

$$\begin{aligned} \text{Timer latch : } T_{\text{scp}} & \quad T_{\text{scp}} \approx C \times V/I \text{ [s]} \\ & \quad V : \text{Threshold voltage TYP } 1.8\text{V} \\ & \quad I : \text{SCP charge current TYP } 2.5\mu\text{A} \end{aligned}$$

(5) RT pin constant setting method (Capacitor charge/discharge current setting)

The CT pin capacitor charge/discharge current can be set for triangular wave generation by connecting R between the RT pin and GND.

Determine the R value as follows :

$$\begin{aligned} \text{Charge/discharge current : } I_{\text{rt}} & \quad I_{\text{rt}} \approx V/R \text{ [A]} \\ & \quad V : \text{R pin voltage TYP } 0.98\text{V} \end{aligned}$$

(6) CT pin constant setting method (Triangular wave oscillation frequency setting)

The triangular wave oscillation can be set (together with the setting of charge/discharge current setting of RT pin) by connecting C between the CT pin and GND.

Determine the C value as follows :

$$\begin{aligned} \text{Triangular wave oscillation frequency : } F_{\text{osc}} & \quad F_{\text{osc}} \approx 1/\{2 \times C \times V/I\} \text{ [Hz]} \\ & \quad V : \text{Triangle wave amplitude TYP } 0.5\text{V (} F_{\text{osc}} = 10\text{kHz)} \\ & \quad \text{*Note that the amplitude increases with the frequency.} \\ & \quad I : \text{Capacitor charge/discharge current. See the RT pin constant} \\ & \quad \text{setting method of (5).} \end{aligned}$$

