



Light LED

Product Data Sheet

LTW-M140SXT57

Spec No.: DS25-2014-0165

Effective Date: 05/01/2015

Revision: A

LITE-ON DCC

RELEASE

BNS-OD-FC001/A4

LIGHT LED LTW-M140SXT57

1. Description

The LiteON M140 Product series is a wide beam angle standard-dimension package, combining the lifetime and reliability advantages of Light Emitting Diodes with the brightness of conventional lighting. It gives you total design freedom and unmatched brightness, creating a new opportunities for solid state lighting to displace conventional lighting technologies.

1.1 Features

- Package in 8mm tape on 7" diameter reels.
- Compatible with automatic placement equipment.
- Compatible with infrared and vapor phase reflow solder process.
- EIA STD package.
- I.C. compatible.
- Meet green product and Pb-free(According to RoHS)

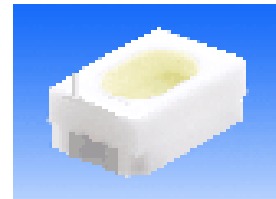

1.2 Available Part Numbers

CCT	Part Number
5700K	LTW-M140SXT57

**LIGHT LED
LTW-M140SXT57**

2. Outline Dimensions

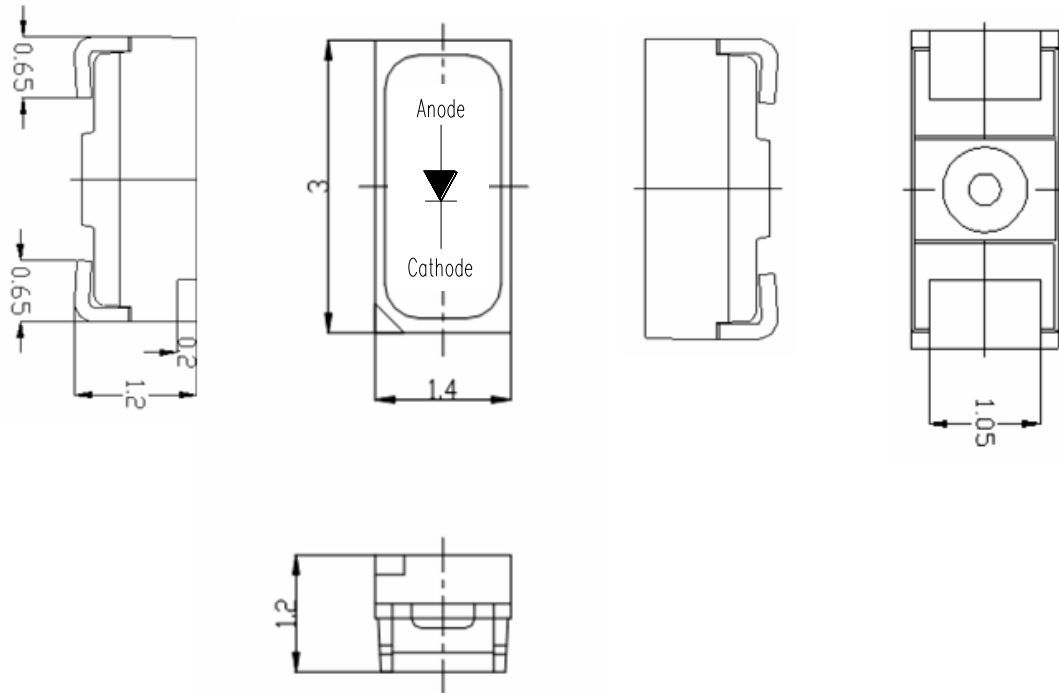

Part No.	Lens Color	Source Color
LTW-M140SXT57	Yellow	InGaN

Notes:

1. All dimensions are in millimeters.
2. Tolerance is ± 0.1 mm (.008") unless otherwise noted.

LIGHT LED
LTW-M140SXT57

3. Absolute Maximum Ratings at $T_a=25^{\circ}\text{C}$

Parameter	Symbol	Rating	Unit
Power Dissipation	P_o	120	mW
Continuous Forward Current	I_F	30	mA
Pulse Forward Current	I_{FP}	100	mA
Operating Temperature Range	T_{opr}	-30~ +85	$^{\circ}\text{C}$
Storage Temperature Range	T_{stg}	-40 ~ +100	$^{\circ}\text{C}$
Junction Temperature	T_j	≤ 100	$^{\circ}\text{C}$

Notes :

1. Forbid to operating at reverse voltage condition for long.
2. 1/10 duty cycle, Pulse width $\leq 100 \mu\text{s}$.

LIGHT LED LTW-M140SXT57

4. Electro-Optical Characteristics

4.1 Typical Performance

Parameter	Symbol	Values		Unit	Test Condition
Correlated Color Temperature	CCT	Typ.	5700	°K	
Chromaticity Coordinates	x	Typ.	0.330	-	$I_F = 20\text{mA}$
	y	Typ.	0.345		
Luminous Flux ¹	Φ_v	Min	6.1	lm	
		Typ.	7.5		
		Max.	9.3		
Color Rendering Index	CRI	Typ.	72	-	
Viewing Angle	$2\theta_{1/2}$	Typ.		deg	
Forward Voltage	V_F	Min	2.9	V	
		Typ.	-		
		Max.	3.6		

Notes

- Luminous flux is the total luminous flux output as measured with an integrating sphere.
- Iv (flux Φ_v) classification code is marked on each packing bag.
- The chromaticity coordinates (x, y) is derived from the 1931 CIE chromaticity diagram.
- Caution in ESD:
Static Electricity and surge damages the LED. It is recommended using a wrist band or anti-electrostatic glove when handling the LED. All devices, equipment and machinery must be properly grounded.
- CAS140B is the test standard for the chromaticity coordinates (x, y) & Φ_v .
- The chromaticity coordinates (x, y) guarantee should be added +/- 0.01 tolerances
- CRI measurement allowance is ± 5
- Forward Voltage measurement allowance is ± 0.1

**LIGHT LED
LTW-M140SXT57**

4.2 Typical Electrical / Optical Characteristics Curves

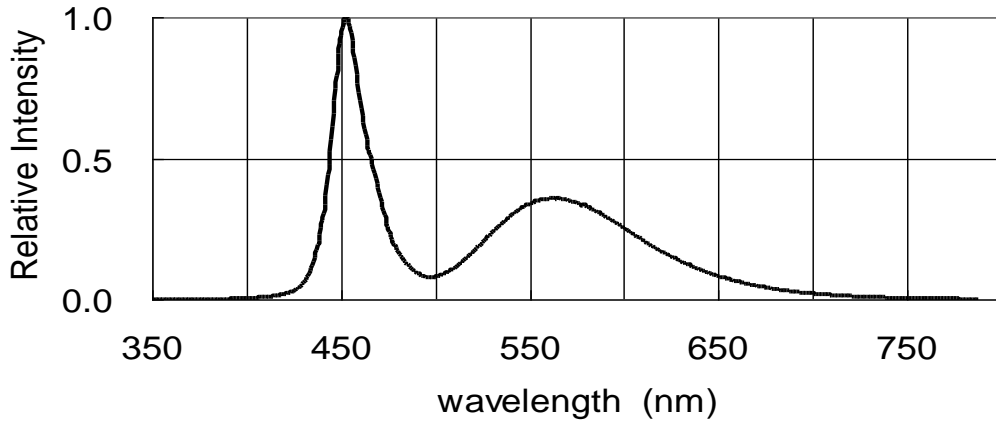

Fig.1 RELATIVE INTENSITY VS. WAVELENGTH

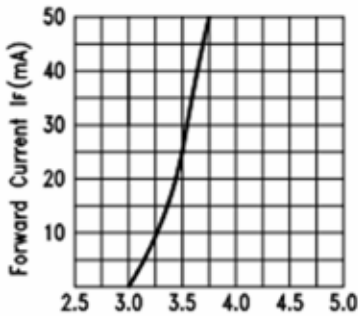

Fig.2 Forward Current vs. Forward Voltage

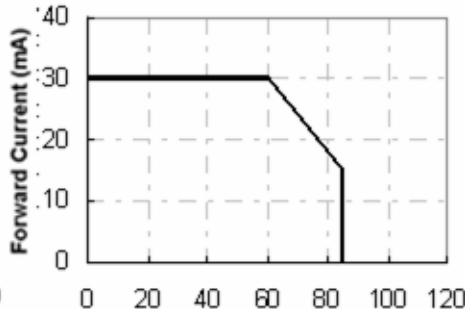

Fig.3 Forward Current Derating Curve

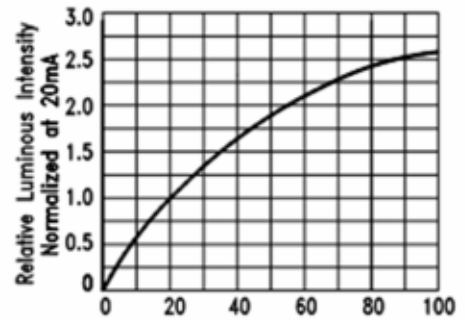

Fig.4 Relative Luminous Intensity vs. Forward Current

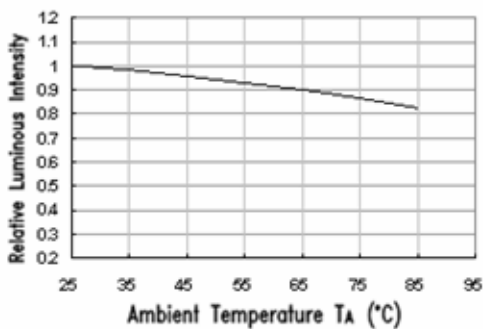

Fig.5 Luminous Intensity vs. Ambient Temperature

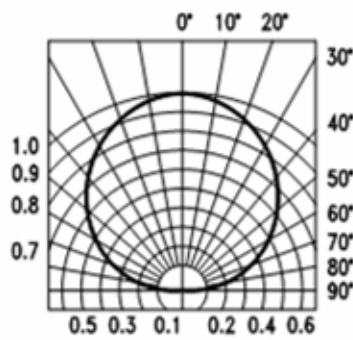

Fig.6 Spatial Distribution

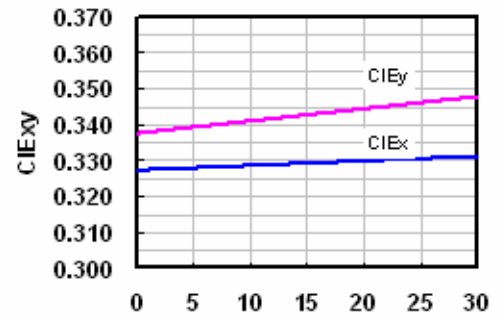
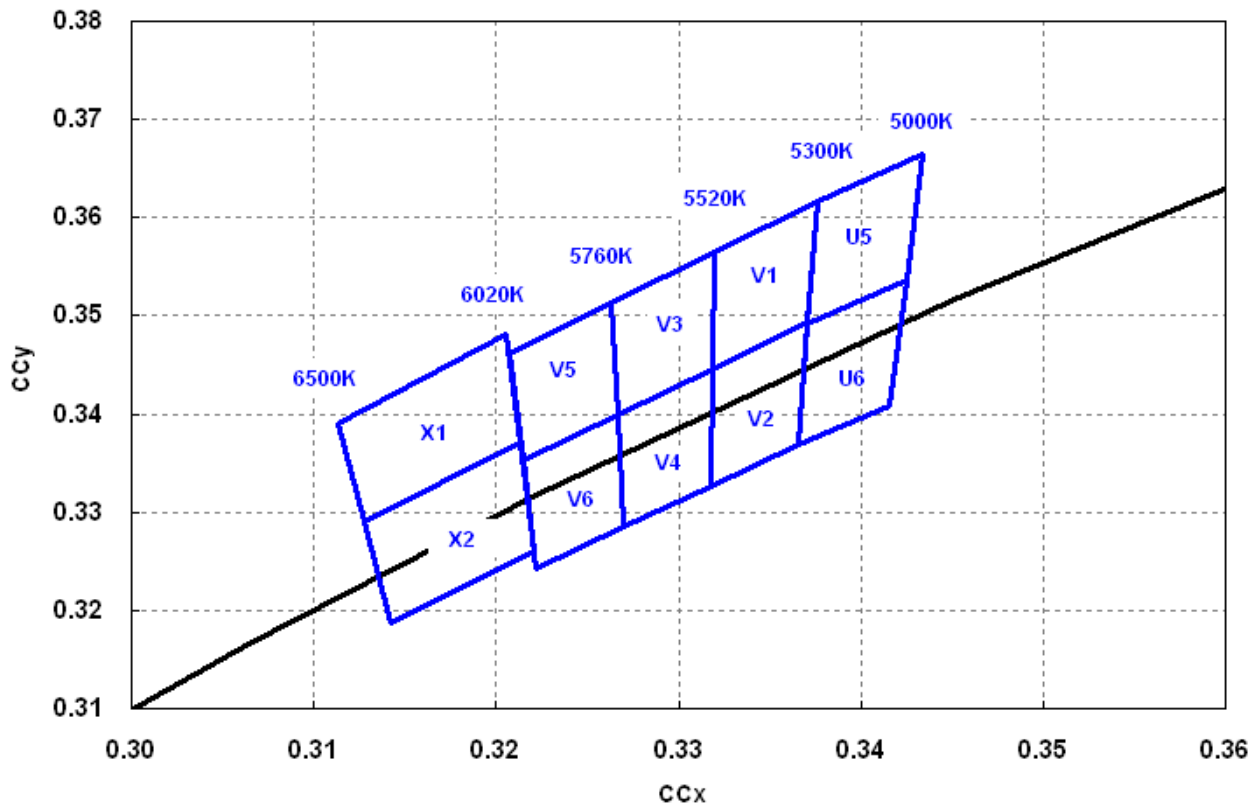

Fig.7. CIExy vs. Forward Current

**LIGHT LED
LTW-M140SXT57**

5. Binning Definition

5.1 Color Bin



LIGHT LED LTW-M140SXT57

5.2 Color Rank

X1	x	0.3128	0.3113	0.3205	0.3213
	y	0.3290	0.3390	0.3481	0.3371
X2	x	0.3142	0.3128	0.3213	0.3221
	y	0.3187	0.3290	0.3371	0.3261
V5	x	0.3215	0.3207	0.3263	0.3267
	y	0.3353	0.3462	0.3513	0.3399
V6	x	0.3222	0.3215	0.3267	0.3270
	y	0.3243	0.3353	0.3399	0.3285
V3	x	0.3267	0.3263	0.3320	0.3319
	y	0.3399	0.3513	0.3565	0.3446
V4	x	0.3270	0.3267	0.3319	0.3318
	y	0.3285	0.3399	0.3446	0.3327
V1	x	0.3319	0.3320	0.3376	0.3371
	y	0.3446	0.3565	0.3616	0.3493
V2	x	0.3318	0.3319	0.3371	0.3366
	y	0.3327	0.3446	0.3493	0.3369
U5	x	0.3371	0.3376	0.3465	0.3455
	y	0.3493	0.3616	0.3690	0.3555
U6	x	0.3366	0.3371	0.3455	0.3444
	y	0.3369	0.3493	0.3555	0.3430

Tolerance on each Hue (x, y) bin is +/- 0.01.

**LIGHT LED
LTW-M140SXT57**

5.3 Flux Bin

Luminous Spec. Table		
Bin Code	Flux (lm) and IV(mcd) at $I_F = 20\text{mA}$	
	lm	
	Min.	Max.
K2	6.1	7.0
K3	7.0	8.1
K4	8.1	9.3

Tolerance on each Luminous Flux bin is +/- 10%.

5.4 Voltage Bin

V_F Spec. Table		
VF Bin	Forward Voltage (V) at $I_F = 20\text{mA}$	
	Min.	Max.
V0	2.9	3.0
V1	3.0	3.1
V2	3.1	3.2
V3	3.2	3.3
V4	3.3	3.4
V5	3.4	3.5

Tolerance on each Forward Voltage bin is +/- 0.1V

**LIGHT LED
LTW-M140SXT57**

6. Bin Code List

※ **Notes: Full Rank on Label**

Example: V0 / K0 / M3

Forward Voltage Rank	Luminous Flux Rank	Color Rank
V0	K2	X1

7. Reflow Soldering Characteristics

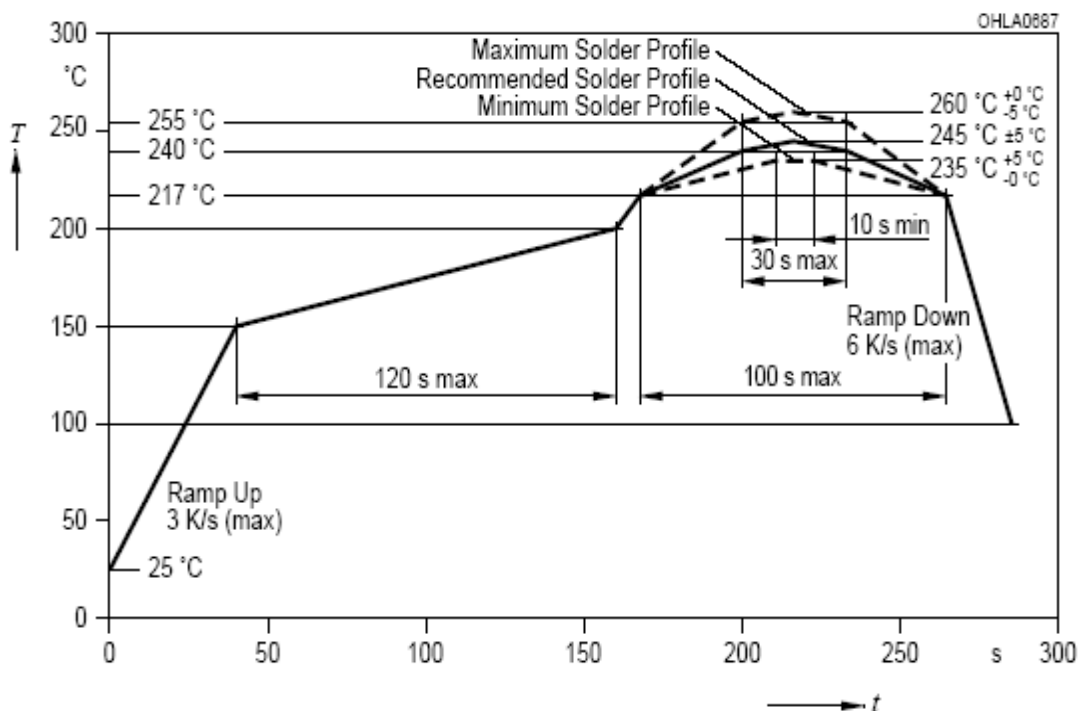

LIGHT LED
LTW-M140SXT57

1. The LEDs can be soldered using the reflow soldering or hand soldering method. The recommended hand soldering condition is 350 °C max. and 2 secs max. for one time only, and the recommended reflow soldering condition is 260 °C max. and 5 secs max. for three times max.
2. All temperatures refer to topside of the package, measured on the package body surface.
3. The soldering condition referring to J-STD-020B. The storage ambient for the LEDs should not exceed 30 °C temperature or 70% relative humidity. It is recommended that LEDs out of their original packaging are soldered within one week. For extended storage out of their original packaging, it is recommended that the LEDs were stored in a sealed container with appropriate desiccant, or desiccators with nitrogen ambient. If the LEDs were unpacked more than 168hrs, baking the LEDs at 60 °C for 24hrs before soldering process.
4. The soldering profile could be further referred to different soldering grease material characteristic. The grease vendor will provide this information.
5. A rapid-rate process is not recommended for the LEDs cooling down from the peak temperature.
6. Although the recommended reflow conditions are specified above, the reflow or hand soldering condition at the lowest possible temperature is desirable for the LEDs.
7. LiteOn cannot make a guarantee on the LEDs which have been already assembled using the dip soldering method.

**LIGHT LED
LTW-M140SXT57**

8. Reliability Test

Test Item	Test Condition	Note	Number of Damaged
Resistance to Soldering Heat (Reflow Soldering)	Tsld=260°C, 10sec. (Pre treatment 30°C,60%,168hrs.)	2 times	0/30
Solderability (Reflow Soldering)	Tsld=245±5°C, 3sec. (Lead Free Solder)	1 time Over 95%	0/30
Thermal Shock	-30°C ~ 85°C 30min.. 30min.	200 cycles	0/30
Temperature Cycle	-40°C ~ 25°C ~ 100°C ~ 25°C 30min. 5min. 30min. 5min.	100 cycles	0/30
High Temperature Storage	Ta=100°C	1000 hrs.	0/30
Temperature Humidity Storage	Ta=60°C, RH=90%	1000 hrs.	0/30
Low Temperature Storage	Ta=-40°C	1000 hrs.	0/30
Steady State Operating Life Condition 1	Ta=25°C, IF=20mA	1000 hrs.	0/30
Steady State Operating Life Condition 2	Ta=25°C, IF=30mA	1000 hrs.	0/30
Steady State Operating Life of High Temperature	Ta=85°C, IF=20mA	1000 hrs.	0/30
Steady State Operating Life of High Humidity Heat	60°C, RH=90% , IF=20mA	1000 hrs.	0/30
Steady State Operating Life of low Temperature	Ta=-30°C, IF=20mA	1000 hrs.	0/30

LIGHT LED LTW-M140SXT57

9. User Guide

■ Cleaning

Do not use unspecified chemical liquid to clean LED they could harm the package. If cleaning is necessary, immerse the LED in ethyl alcohol or isopropyl alcohol at normal temperature for less than one minute.

■ Recommend Printed Circuit Board Attachment Pad

Infrared / vapor phase

Reflow Soldering

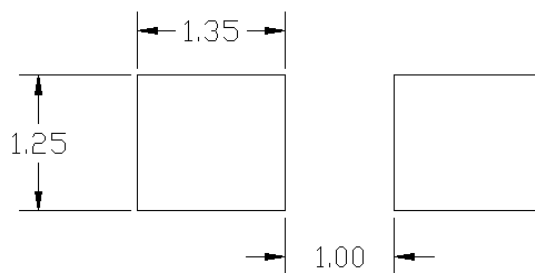

■ Package Dimensions of Tape

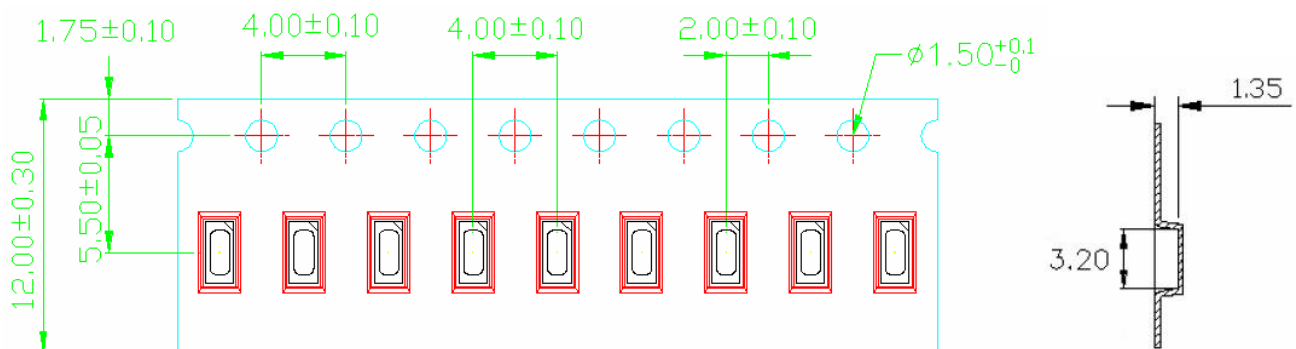

Note: All dimensions are in millimeters.

LIGHT LED
LTW-M140SXT57

■ Package Dimensions of Reel

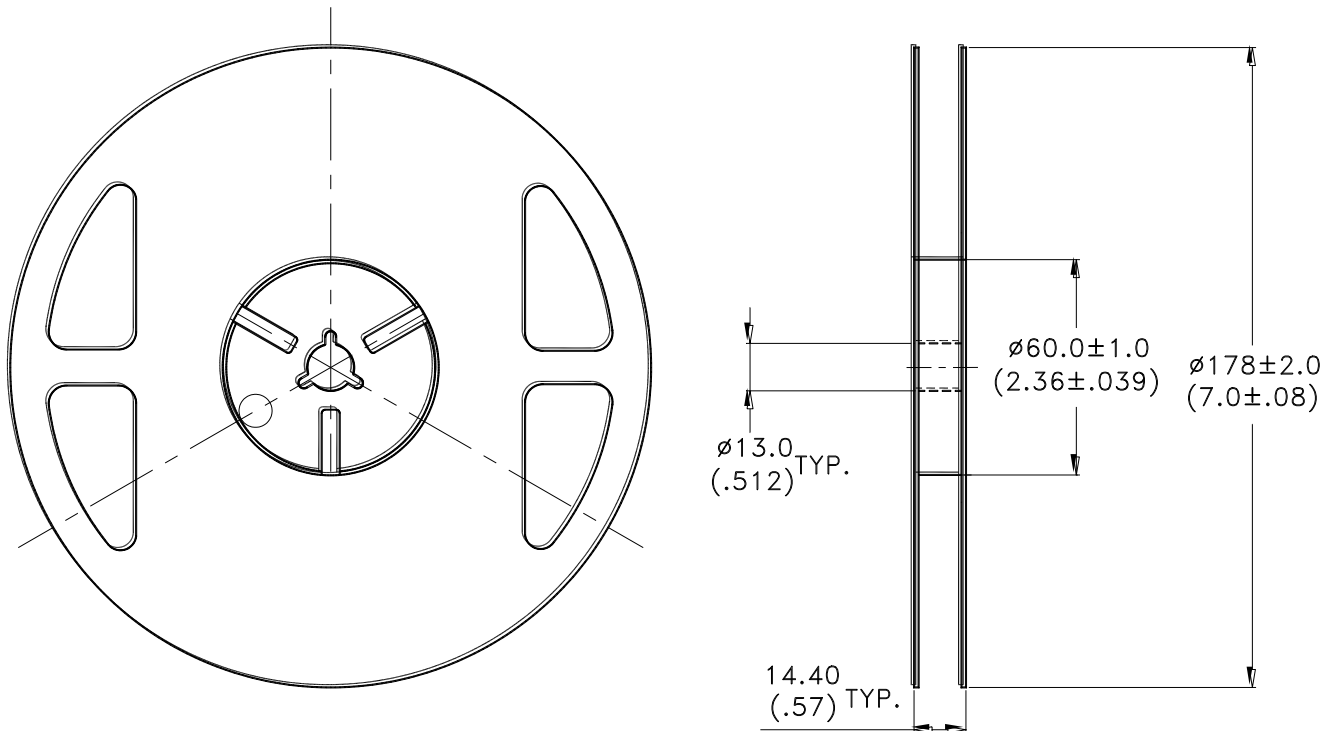

Notes:

1. Empty component pockets sealed with top cover tape.
2. 7 inch reel-2000 pieces per reel **only**.
3. The maximum number of consecutive missing lamps is two.
4. In accordance with EIA-481-1-B specifications.

LIGHT LED LTW-M140SXT57

10. Cautions

10.1 Application

The LEDs described here are intended to be used for ordinary electronic equipment (such as office equipment, communication equipment and household applications). Consult Liteon's Sales in advance for information on applications in which exceptional reliability is required, particularly when the failure or malfunction of the LEDs may directly jeopardize life or health (such as in aviation, transportation, traffic control equipment, medical and life support systems and safety devices).

10.2 Storage

This product is qualified as Moisture sensitive Level 3 per JEDEC J-STD-020 Precaution when handling this moisture sensitive product is important to ensure the reliability of the product.

The package is sealed:

The LEDs should be stored at 30°C or less and 90%RH or less. And the LEDs are limited to use within one year, while the LEDs is packed in moisture-proof package with the desiccants inside.

The package is opened:

The LEDs should be stored at 30°C or less and 60%RH or less. Moreover, the LEDs are limited to solder process within 168hrs. If exceed the storage limiting time since opened, that we recommended to baking LEDs at 60°C at least 24hrs. To seal the remainder LEDs return to package, it's recommended to be with workable desiccants in original package.

10.3 Cleaning

Use alcohol-based cleaning solvents such as isopropyl alcohol to clean the LED if necessary.

10.4 Drive Mode

An LED is a current-operated device. In order to ensure intensity uniformity on multiple LEDs connected in parallel in an application, it is recommended that a current limiting resistor be incorporated in the drive circuit, in series with each LED as shown in Circuit A below

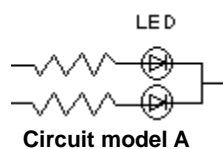

(A) Recommended circuit.

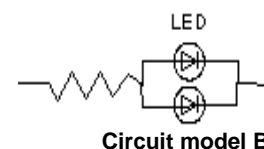

(B) The brightness of each LED might appear different due to the differences in the I-V characteristics of those LEDs.

LIGHT LED LTW-M140SXT57

10.5 ESD (Electrostatic Discharge)

Static Electricity or power surge will damage the LED. Suggestions to prevent ESD damage:

- Use of a conductive wrist band or anti-electrostatic glove when handling these LEDs.
- All devices, equipment, and machinery must be properly grounded.
- Work tables, storage racks, etc. should be properly grounded.
- Use ion blower to neutralize the static charge which might have built up on surface of the LED's plastic lens as a result of friction between LEDs during storage and handling.

ESD-damaged LEDs will exhibit abnormal characteristics such as high reverse leakage current, low forward voltage, or "no lightup" at low currents. To verify for ESD damage, check for "light up" and Vf of the suspect LEDs at low currents. The Vf of "good" LEDs should be $>2.0V@0.1mA$ for InGaN product and $>1.4V@0.1mA$ for AlInGaP product.

10.6 Suggested Checking List:

- Training and Certification
 1. Everyone working in a static-safe area is ESD-certified?
 2. Training records kept and re-certification dates monitored?
- Static-Safe Workstation & Work Areas
 1. Static-safe workstation or work-areas have ESD signs?
 2. All surfaces and objects at all static-safe workstation and within 1 ft measure less than 100V?
 3. All ionizer activated, positioned towards the units?
 4. Each work surface mats grounding is good?
- Personnel Grounding
 1. Every person (including visitors) handling ESD sensitive (ESDS) items wear wrist strap, heel strap or conductive shoes with conductive flooring?
 2. If conductive footwear used, conductive flooring also present where operator stand or walk?
 3. Garments, hairs or anything closer than 1 ft to ESD items measure less than 100V*?
 4. Every wrist strap or heel strap/conductive shoes checked daily and result recorded for all DLs?
 5. All wrist strap or heel strap checkers calibration up to date?

LIGHT LED LTW-M140SXT57

Note: *50V for Blue LED.

- Device Handling
 1. Every ESDS items identified by EIA-471 labels on item or packaging?
 2. All ESDS items completely inside properly closed static-shielding containers when not at static-safe workstation?
 3. No static charge generators (e.g. plastics) inside shielding containers with ESDS items?
 4. All flexible conductive and dissipative package materials inspected before reuse or recycle?

- Others
 1. Audit result reported to entity ESD control coordinator?
 2. Corrective action from previous audits completed?
 3. Are audit records complete and on file?

10.7 Others:

- Do not put any pressure on the light emitting surface either by finger or any hand tool and do not stack the products. Stress or pressure may cause damage to the wires of the LED array.
- This product is not designed for the use under any of the following conditions, please confirm the performance and reliability are well enough if you use it under any of the following conditions
- Do not use sulfur-containing materials in commercial products including the materials such as seals and adhesives that may contain sulfur.
- Do not put this product in a place with a lot of moisture (over 85% relative humidity), dew condensation, briny air, and corrosive gas (Cl, H₂S, NH₃, SO₂, NO_x, etc.), exposure to a corrosive environment may affect silver plating.
- The appearance and specifications of the product may be modified for improvement without prior notice.