

## Features

- \* High Intensity.
- \* Popular T-1 diameter package.
- \* Selected minimum intensities.
- \* Wide viewing angle.
- \* General purpose leads.
- \* Reliable and rugged.

## Package Dimensions

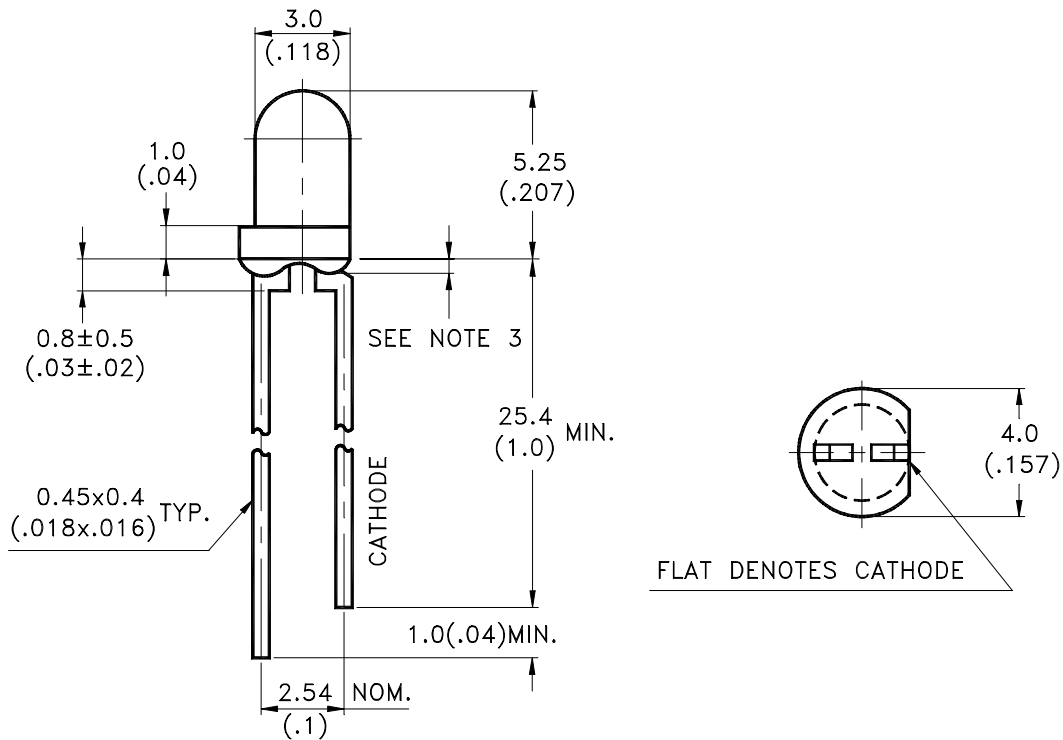

| Part No. | Lens           | Source Color |
|----------|----------------|--------------|
| LTL-4231 | Green Diffused | Green        |

### Notes:

1. All dimensions are in millimeters (inches).
2. Tolerance is  $\pm 0.25\text{mm}(.010\text{'})$  unless otherwise noted.
3. Protruded resin under flange is 1.0mm(.04") max.
4. Lead spacing is measured where the leads emerge from the package.
5. Specifications are subject to change without notice.



**Absolute Maximum Ratings at TA=25°C**

| Parameter  | Maximum Rating      | Unit  |
|--|---------------------|-------|
| Power Dissipation  | 100                 | mW    |
| Peak Forward Current<br>(1/10 Duty Cycle, 0.1ms Pulse Width) | 120                 | mA    |
| Continuous Forward Current                                   | 30                  | mA    |
| Derating Linear From 50°C                                    | 0.4                 | mA/°C |
| Reverse Voltage  | 5                   | V     |
| Operating Temperature Range                                  | -55°C to + 100°C    |       |
| Storage Temperature Range                                    | -55°C to + 100°C    |       |
| Lead Soldering Temperature<br>[1.6mm(.063") From Body]       | 260°C for 5 Seconds |       |

**Electrical / Optical Characteristics at TA=25°C**

| Parameter                | Symbol            | Min. | Typ. | Max. | Unit | Test Condition                    |
|--------------------------|-------------------|------|------|------|------|-----------------------------------|
| Luminous Intensity       | I <sub>v</sub>    | 3.7  | 12.6 |      | mcd  | I <sub>F</sub> = 10mA<br>Note 1,4 |
| Viewing Angle            | 2θ <sub>1/2</sub> |      | 40   |      | deg  | Note 2 (Fig.6)                    |
| Peak Emission Wavelength | λ <sub>P</sub>    |      | 565  |      | nm   | Measurement<br>@Peak (Fig.1)      |
| Dominant Wavelength      | λ <sub>d</sub>    |      | 569  |      | nm   | Note 3                            |
| Spectral Line Half-Width | Δλ                |      | 30   |      | nm   |                                   |
| Forward Voltage          | V <sub>F</sub>    |      | 2.1  | 2.6  | V    | I <sub>F</sub> = 20mA             |
| Reverse Current          | I <sub>R</sub>    |      |      | 100  | μA   | V <sub>R</sub> = 5V               |
| Capacitance              | C                 |      | 35   |      | pF   | V <sub>F</sub> = 0 , f = 1MHz     |

- Note: 1. Luminous intensity is measured with a light sensor and filter combination that approximates the CIE (Commission International De L'Eclairage) eye-response curve.
2. θ<sub>1/2</sub> is the off-axis angle at which the luminous intensity is half the axial luminous intensity.
3. The dominant wavelength, λ<sub>d</sub> is derived from the CIE chromaticity diagram and represents the single wavelength which defines the color of the device.
4. The I<sub>v</sub> guarantee should be added ± 15% .

## Typical Electrical / Optical Characteristics Curves

(25°C Ambient Temperature Unless Otherwise Noted)

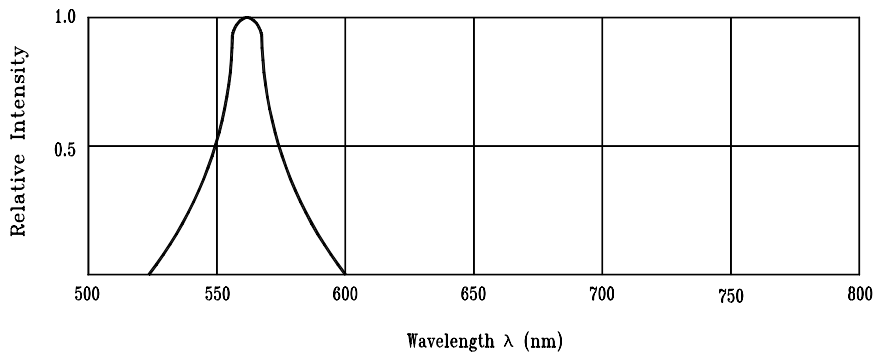

Fig.1 Relative Intensity vs. Wavelength

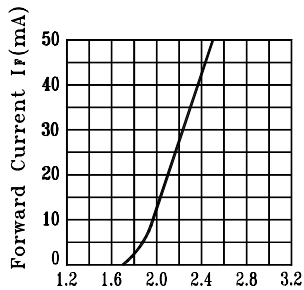

Fig.2 Forward Current vs. Forward Voltage

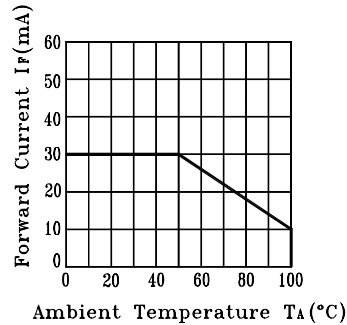

Fig.3 Forward Current Derating Curve

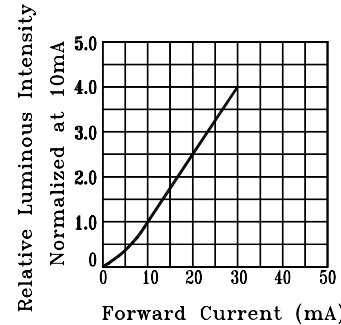

Fig.4 Relative Luminous Intensity vs. Forward Current

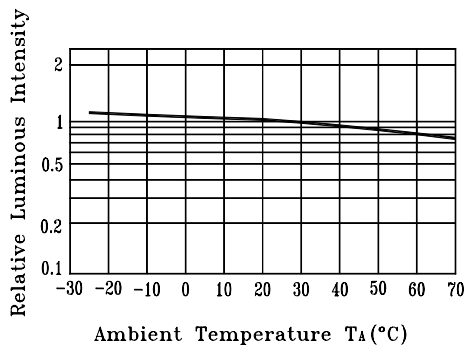

Fig.5 Luminous Intensity vs. Ambient Temperature

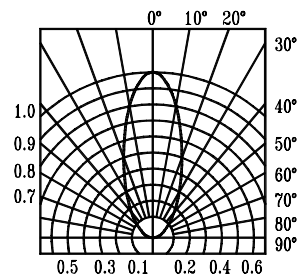

Fig.6 Spatial Distribution