

OSRAM LSG T676

Datasheet

Published by **ams-OSRAM AG**

Tobelbader Strasse 30, 8141 Premstaetten, Austria

Phone +43 3136 500-0

ams-osram.com

© All rights reserved



Multi TOPLED®

LSG T676

Two chip LEDs for indicators that allow to display red, green and yellow by color mixing



Applications

- Electronic Equipment

Features

- Package: white PLCC-4 package, colorless clear resin
- Chip technology: InGaAlP
- Typ. Radiation: 120° (Lambertian emitter)
- Color: $\lambda_{\text{dom}} = 630 \text{ nm}$ (● super red); $\lambda_{\text{dom}} = 570 \text{ nm}$ (● green)
- Optical efficacy: 7 lm/W; 5 lm/W
- Corrosion Robustness Class: 3B
- Qualifications: The product qualification test plan is based on the guidelines of AEC-Q101-REV-C, Stress Test Qualification for Automotive Grade Discrete Semiconductors.
- ESD: 2 kV acc. to ANSI/ESDA/JEDEC JS-001 (HBM, Class 2)

Ordering Information

Type	Brightness ¹⁾	Ordering Code
LSG T676-P7R-1-0+N7Q-24-0		Q65113A1229
• super red	• $I_v = 56 \dots 180 \text{ mcd}$ ($I_F = 20 \text{ mA}$)	
• green	• $I_v = 36 \dots 112 \text{ mcd}$ ($I_F = 20 \text{ mA}$)	

Maximum Ratings

Parameter	Symbol		Values	
			● super red	● green
Operating Temperature	T_{op}	min.	-40 °C	-40 °C
		max.	100 °C	100 °C
Storage Temperature	T_{stg}	min.	-40 °C	-40 °C
		max.	100 °C	100 °C
Junction Temperature	T_j	max.	125 °C	125 °C
Forward Current $T_A = 25\text{ °C}$	I_F	max.	30 mA	30 mA
Forward Current pulsed $t \leq 10\ \mu\text{s}$; $D = 0.005$; $T_A = 25\text{ °C}$	$I_{F\ pulse}$	max.	250 mA	250 mA
Surge Current Single pulses; $t \leq 10\ \mu\text{s}$; $T_A = 25\text{ °C}$	I_{FS}	max.	1000 mA	500 mA
Reverse voltage ²⁾ $T_A = 25\text{ °C}$	V_R	max.	12 V	12 V
ESD withstand voltage acc. to ANSI/ESDA/JEDEC JS-001 (HBM, Class 2)	V_{ESD}		2 kV	2 kV

Characteristics

$I_F = 20 \text{ mA}$; $T_A = 25 \text{ °C}$

Parameter	Symbol		Values	Values
			● super red	● green
Peak Wavelength	λ_{peak}	typ.	645 nm	572 nm
Dominant Wavelength ³⁾	λ_{dom}	min.	627 nm	566 nm
		typ.	630 nm	570 nm
		max.	634 nm	575 nm
Spectral bandwidth at 50% $I_{\text{rel,max}}$	$\Delta\lambda$	typ.	16 nm	16 nm
Viewing angle at 50% I_V	2φ	typ.	120 °	120 °
Forward Voltage ⁴⁾ $I_F = 20 \text{ mA}$	V_F	min.	1.80 V	1.80 V
		typ.	2.00 V	2.10 V
		max.	2.30 V	2.40 V
Reverse current ²⁾ $V_R = 12 \text{ V}$	I_R	max.	10 μA	10 μA
		typ.	0.01 μA	0.01 μA
Temperature Coefficient of Peak Wavelength	$\text{TC}_{\lambda_{\text{peak}}}$	typ.	0.14 nm / K	0.12 nm / K
Real thermal resistance junction/ambient ⁵⁾⁶⁾ 1 chip on	$R_{\text{thJA real}}$	max.	580 K / W	580 K / W
Real thermal resistance junction/solderpoint ⁵⁾ 1 chip on	$R_{\text{thJS real}}$	max.	340 K / W	340 K / W

Brightness Groups

Color of emission	Group	Luminous Intensity ¹⁾ $I_F = 20 \text{ mA}$ min. I_v	Luminous Intensity ¹⁾ $I_F = 20 \text{ mA}$ max. I_v	Luminous Flux ⁷⁾ $I_F = 20 \text{ mA}$ typ. Φ_v
● super red	P7	56 mcd	90 mcd	220 mlm
● super red	P9	63 mcd	100 mcd	240 mlm
● super red	Q	71 mcd	112 mcd	270 mlm
● super red	Q5	80 mcd	125 mcd	310 mlm
● super red	Q7	90 mcd	140 mcd	350 mlm
● super red	Q9	100 mcd	159 mcd	390 mlm
● super red	R	112 mcd	180 mcd	440 mlm
● green	N7	36 mcd	56 mcd	140 mlm
● green	N9	40 mcd	63 mcd	150 mlm
● green	P	45 mcd	71 mcd	170 mlm
● green	P5	50 mcd	80 mcd	200 mlm
● green	P7	56 mcd	90 mcd	220 mlm
● green	P9	63 mcd	100 mcd	240 mlm
● green	Q	71 mcd	112 mcd	270 mlm

Wavelength Groups

● super red

Group	Dominant Wavelength ³⁾ min. λ_{dom}	Dominant Wavelength ³⁾ max. λ_{dom}
1	627 nm	634 nm

Wavelength Groups

● green

Group	Dominant Wavelength ³⁾ min. λ_{dom}	Dominant Wavelength ³⁾ max. λ_{dom}
2	566 nm	569 nm
3	569 nm	572 nm
4	572 nm	575 nm

Group Name on Label

Example: P7-1+N7-2

Color	Brightness	Wavelength
● super red	P7	1
● green	N7	2

Relative Spectral Emission ⁷⁾

$I_{rel} = f(\lambda); I_F = 20 \text{ mA}; T_A = 25 \text{ }^\circ\text{C}$

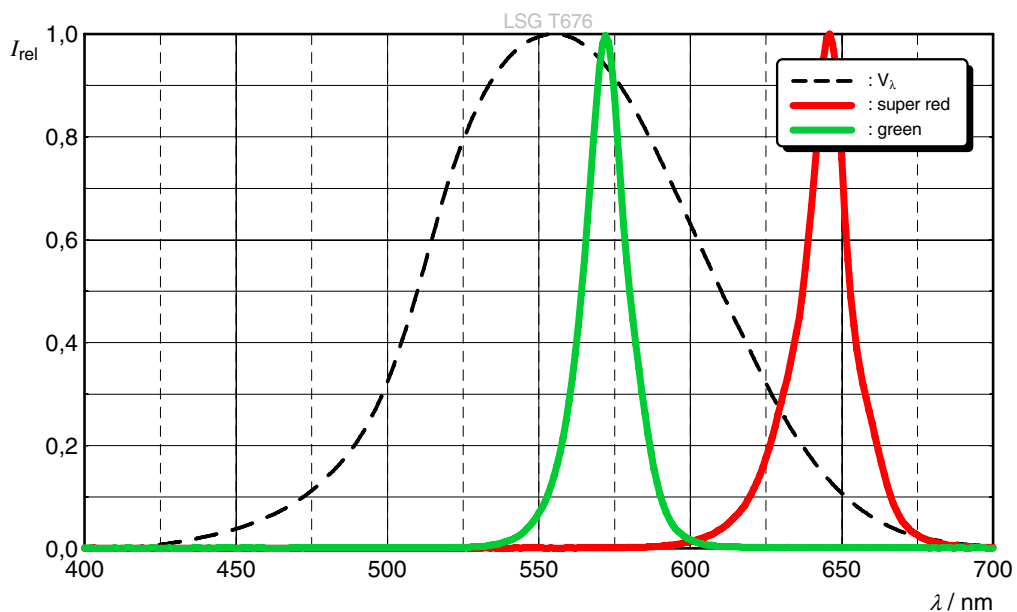

Radiation Characteristics ⁷⁾

$I_{rel} = f(\phi); T_A = 25 \text{ }^\circ\text{C}$

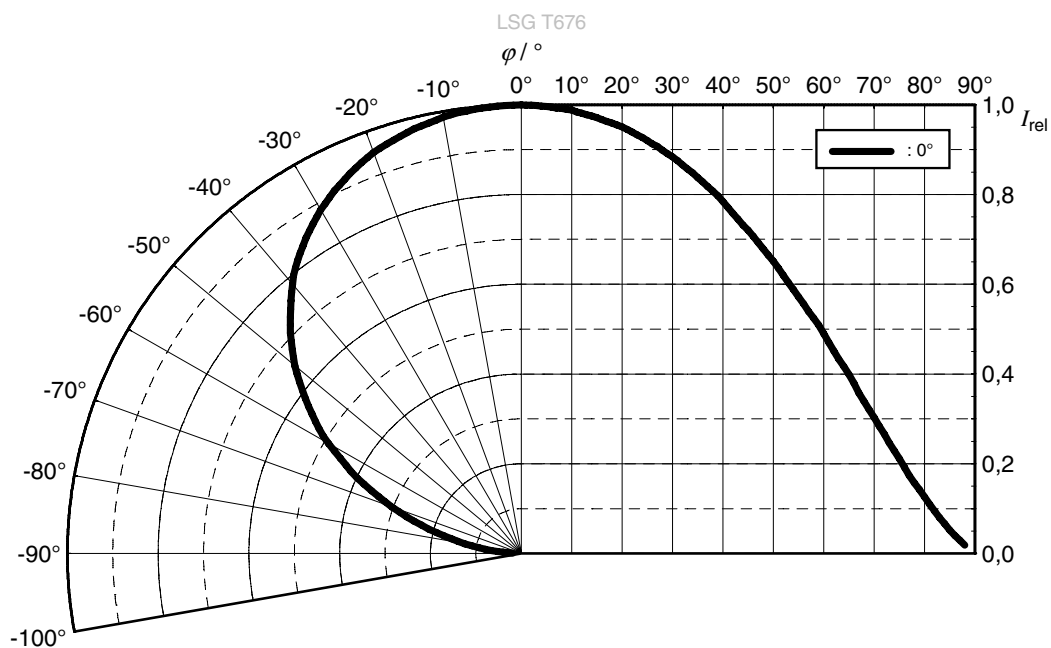

Forward current ⁷⁾

$I_F = f(V_F); T_A = 25\text{ °C}$

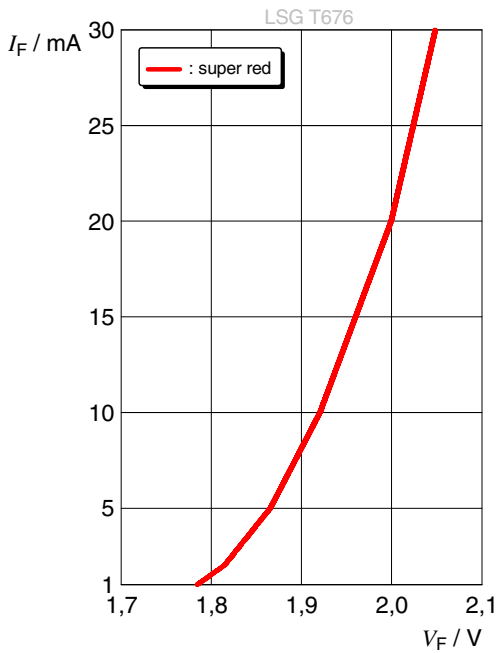

Forward current ⁷⁾

$I_F = f(V_F); T_A = 25\text{ °C}$

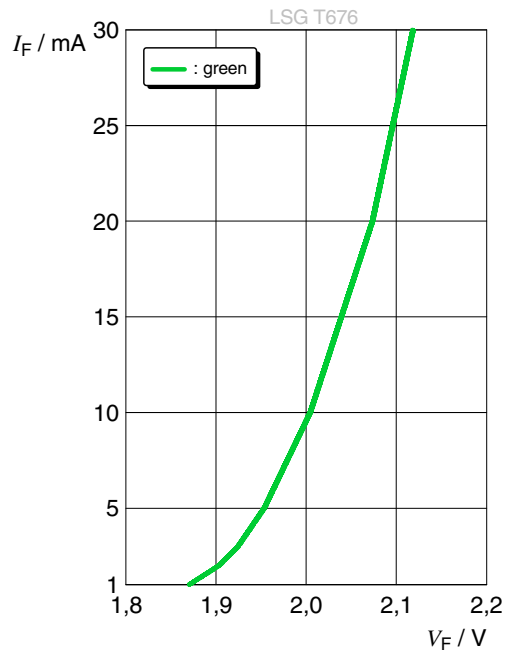

Relative Luminous Intensity ^{7), 8)}

$I_V / I_V(20\text{ mA}) = f(I_F); T_A = 25\text{ °C}$

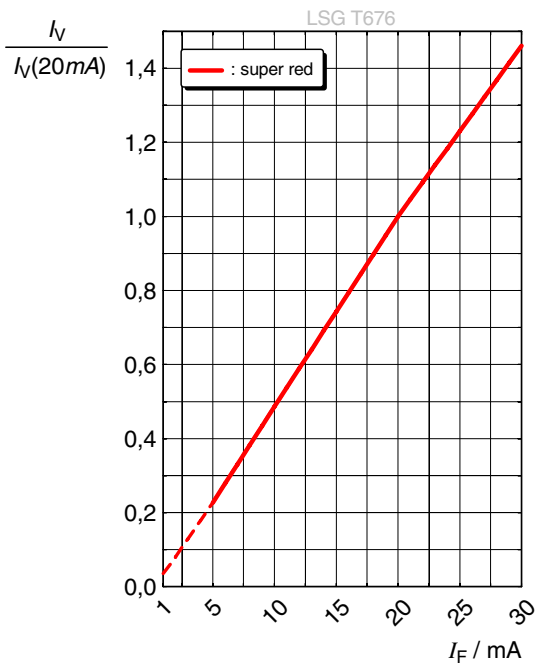

Relative Luminous Intensity ^{7), 8)}

$I_V / I_V(20\text{ mA}) = f(I_F); T_A = 25\text{ °C}$

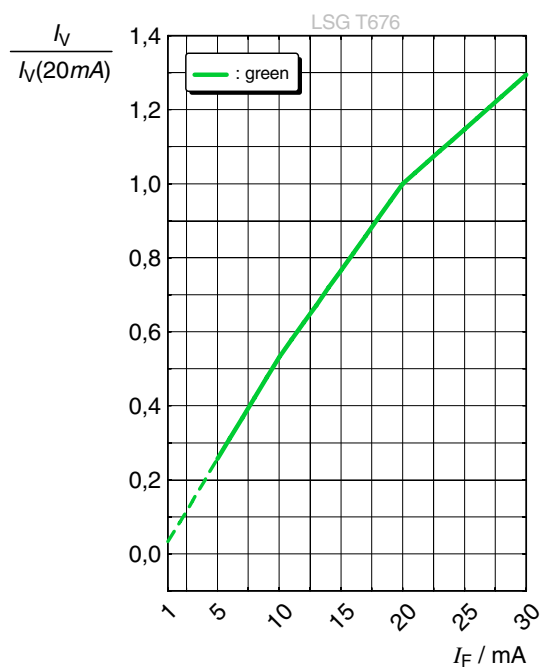

Forward Voltage ⁷⁾

$\Delta V_F = V_F - V_F(25\text{ }^\circ\text{C}) = f(T_j); I_F = 20\text{ mA}$

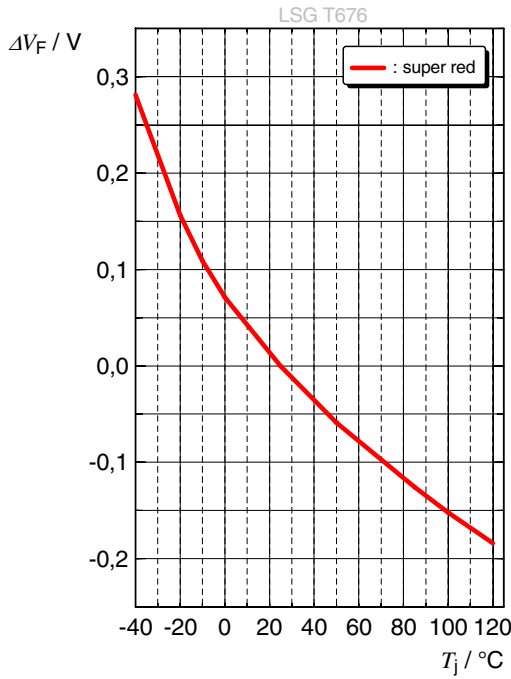

Forward Voltage ⁷⁾

$\Delta V_F = V_F - V_F(25\text{ }^\circ\text{C}) = f(T_j); I_F = 20\text{ mA}$

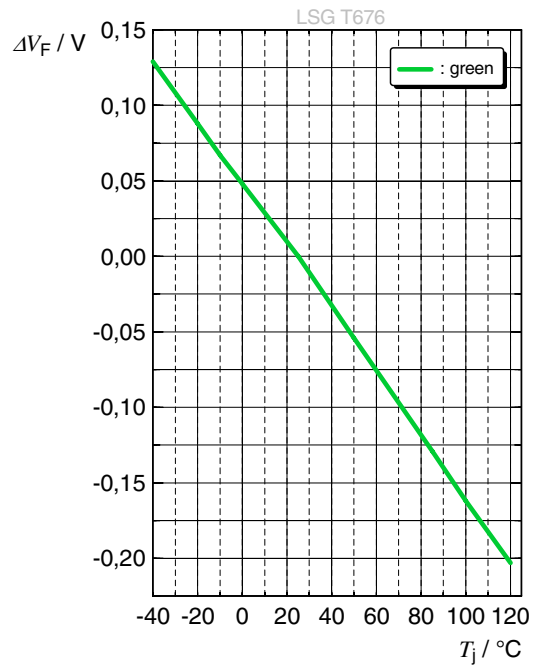

Relative Luminous Intensity ⁷⁾

$I_v/I_v(25\text{ }^\circ\text{C}) = f(T_j); I_F = 20\text{ mA}$

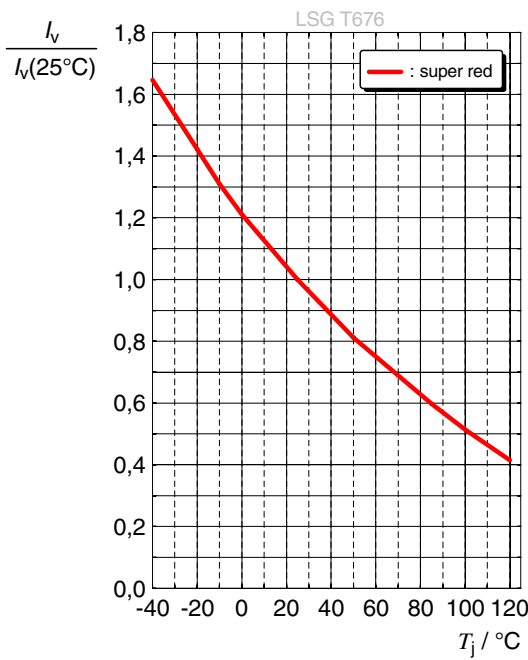

Relative Luminous Intensity ⁷⁾

$I_v/I_v(25\text{ }^\circ\text{C}) = f(T_j); I_F = 20\text{ mA}$

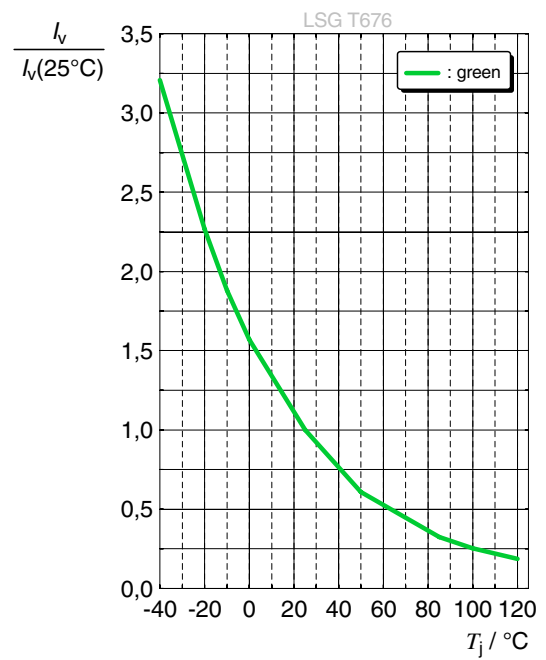

Dominant Wavelength ⁷⁾

$$\lambda_{\text{dom}} = f(T_j); I_F = 20 \text{ mA}$$

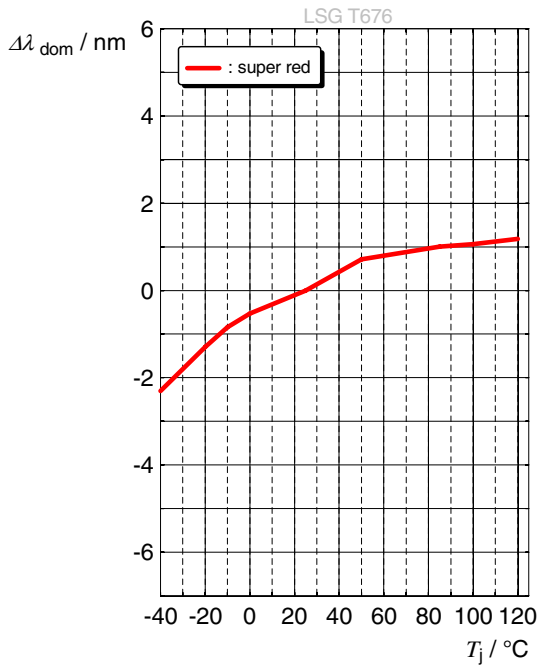

Dominant Wavelength ⁷⁾

$$\lambda_{\text{dom}} = f(T_j); I_F = 20 \text{ mA}$$

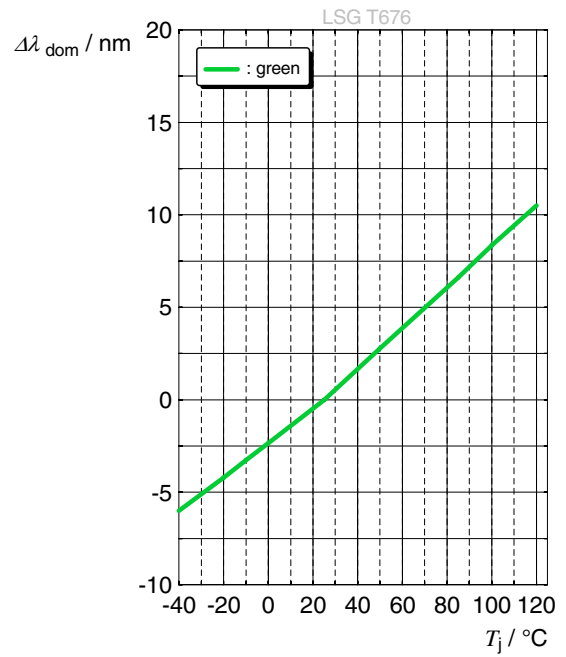

Max. Permissible Forward Current

$I_F = f(T)$; ● super red

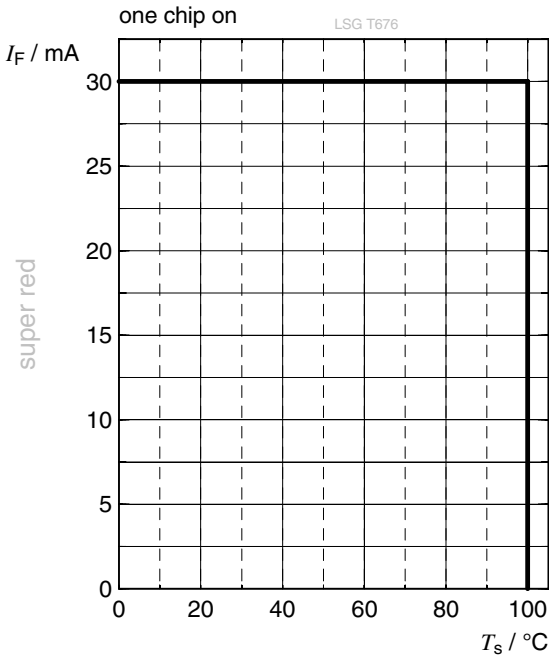

Max. Permissible Forward Current

$I_F = f(T)$; ● green

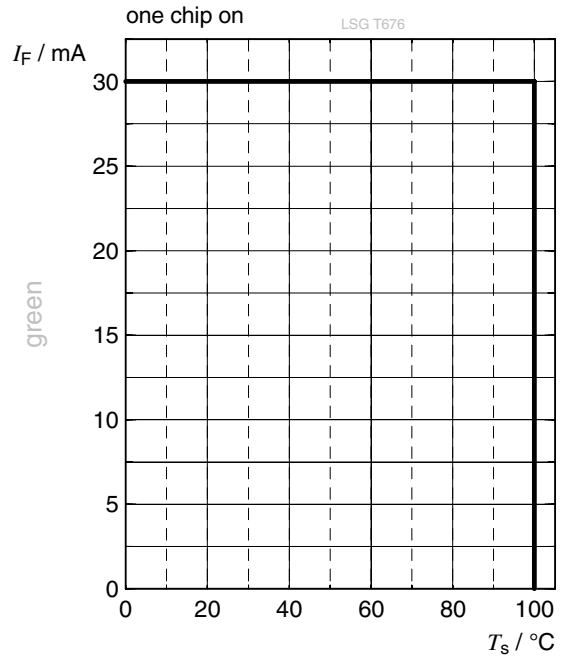

Permissible Pulse Handling Capability

$I_F = f(t_p)$; D: Duty cycle; ● super red

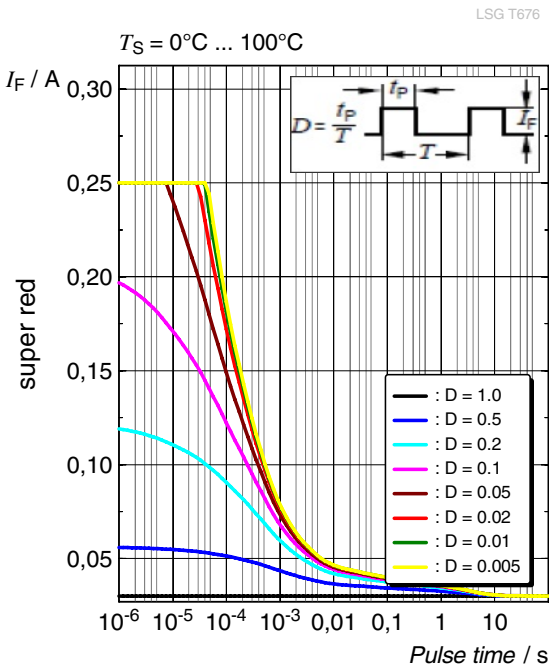

Permissible Pulse Handling Capability

$I_F = f(t_p)$; D: Duty cycle; ● green

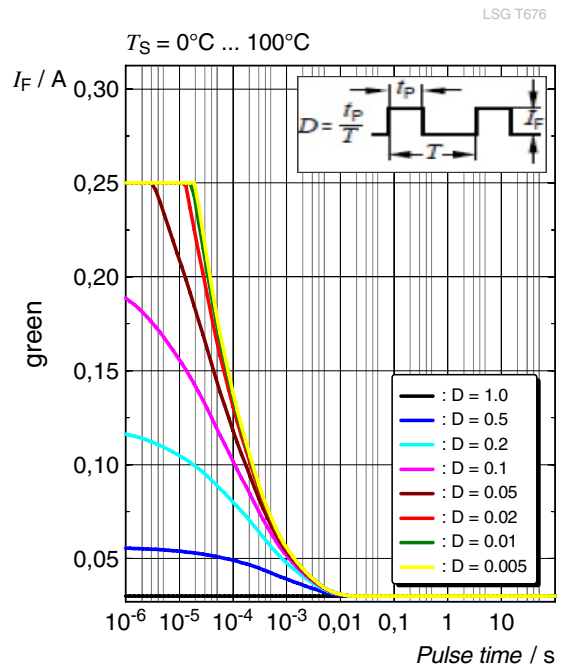

Dimensional Drawing ⁹⁾

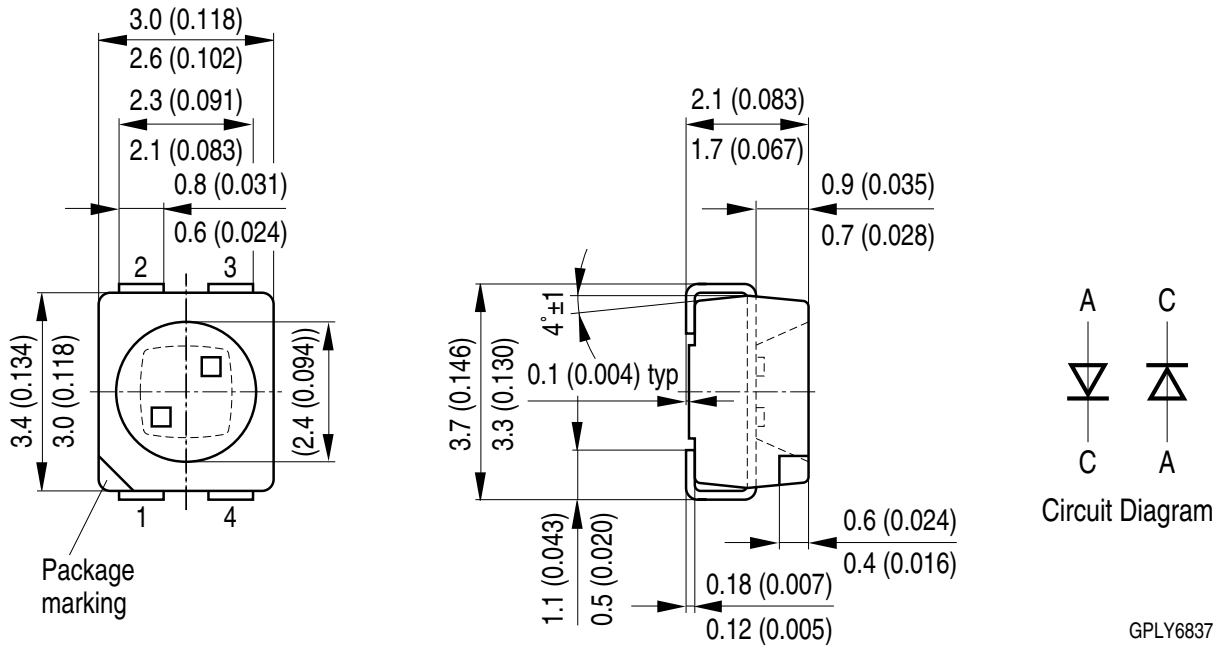

Further Information:

Approximate Weight: 31.0 mg

Corrosion test: Class: 3B
Test condition: 40°C / 90 % RH / 15 ppm H₂S / 14 days (stricter than IEC 60068-2-43)

Recommended Solder Pad ⁹⁾

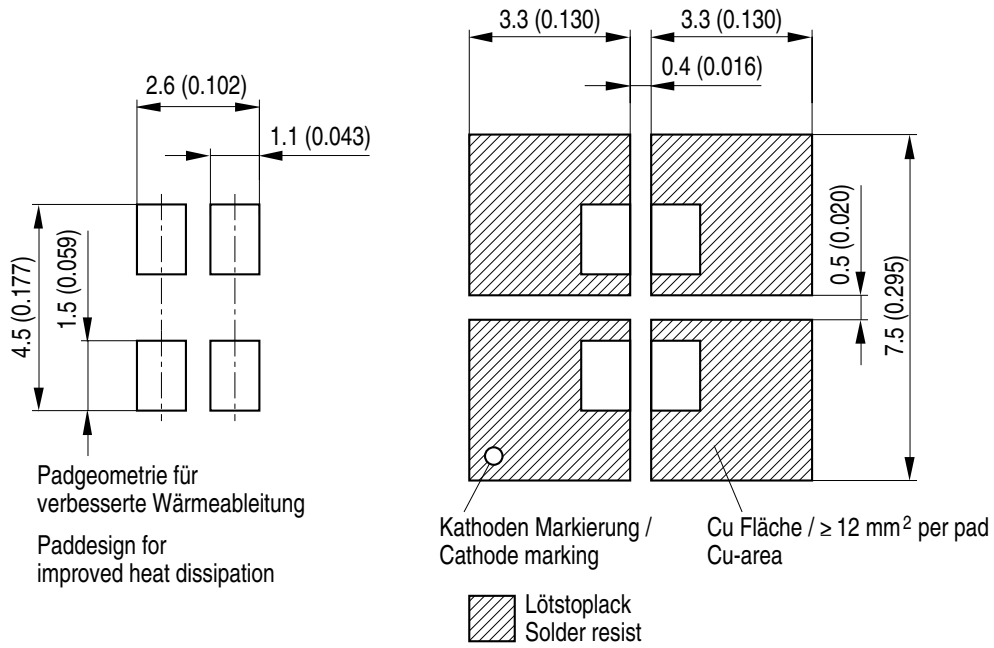

OHLPY439

For superior solder joint connectivity results we recommend soldering under standard nitrogen atmosphere. Package not suitable for ultra sonic cleaning.

Reflow Soldering Profile

Product complies to MSL Level 2 acc. to JEDEC J-STD-020E



Profile Feature	Symbol	Pb-Free (SnAgCu) Assembly			Unit
		Minimum	Recommendation	Maximum	
Ramp-up rate to preheat ^{*)} 25 °C to 150 °C			2	3	K/s
Time t_s T_{Smin} to T_{Smax}	t_s	60	100	120	s
Ramp-up rate to peak ^{*)} T_{Smax} to T_p			2	3	K/s
Liquidus temperature	T_L		217		°C
Time above liquidus temperature	t_L		80	100	s
Peak temperature	T_p		245	260	°C
Time within 5 °C of the specified peak temperature $T_p - 5$ K	t_p	10	20	30	s
Ramp-down rate* T_p to 100 °C			3	6	K/s
Time 25 °C to T_p				480	s

All temperatures refer to the center of the package, measured on the top of the component

* slope calculation DT/Dt : Dt max. 5 s; fulfillment for the whole T-range

Taping ⁹⁾

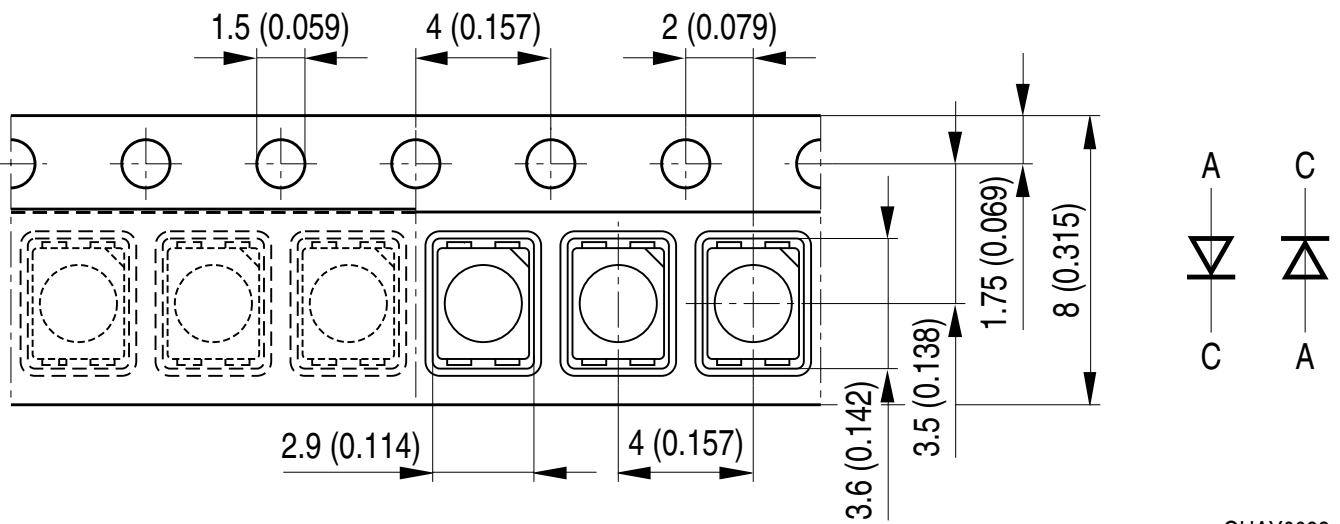

OHAY0093

Tape and Reel ¹⁰⁾

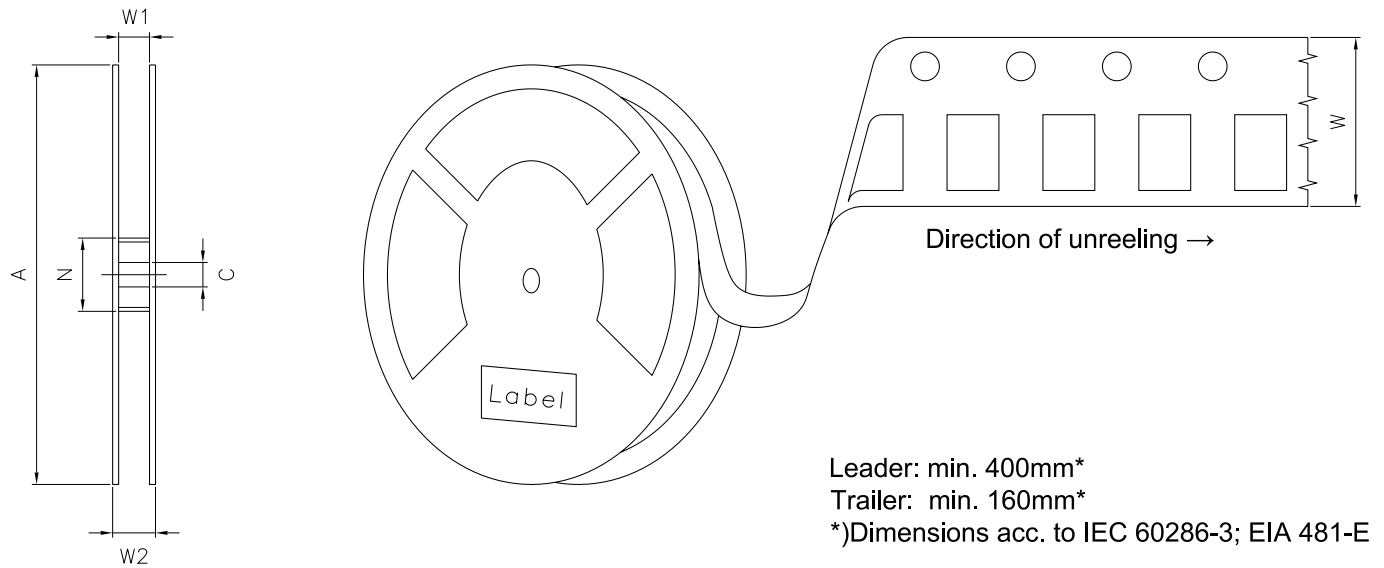

Reel Dimensions

A	W	N_{\min}	W_1	$W_{2\max}$	Pieces per PU
180 mm	$8 + 0.3 / - 0.1$ mm	60 mm	$8.4 + 2$ mm	14.4 mm	2000
330 mm	$8 + 0.3 / - 0.1$ mm	60 mm	$8.4 + 2$ mm	14.4 mm	8000

Barcode-Product-Label (BPL)

OSRAM Opto Semiconductors LX XXXX BIN1: XX-XX-X-XXX-X





RoHS Compliant

(6P) BATCH NO: 1234567890 ML Temp ST
X XXX °C X

(1T) LOT NO: 1234567890 (9D) D/C: 1234

Pack: RXX
DEMY XXX
X_X123_1234.1234 X

(X) PROD NO: 123456789(Q)QTY: 9999 (G) GROUP: XX-XX-X-X

OHA04563

Dry Packing Process and Materials ⁹⁾



OHA00539

Moisture-sensitive product is packed in a dry bag containing desiccant and a humidity card according JEDEC-STD-033.

Type Designation System

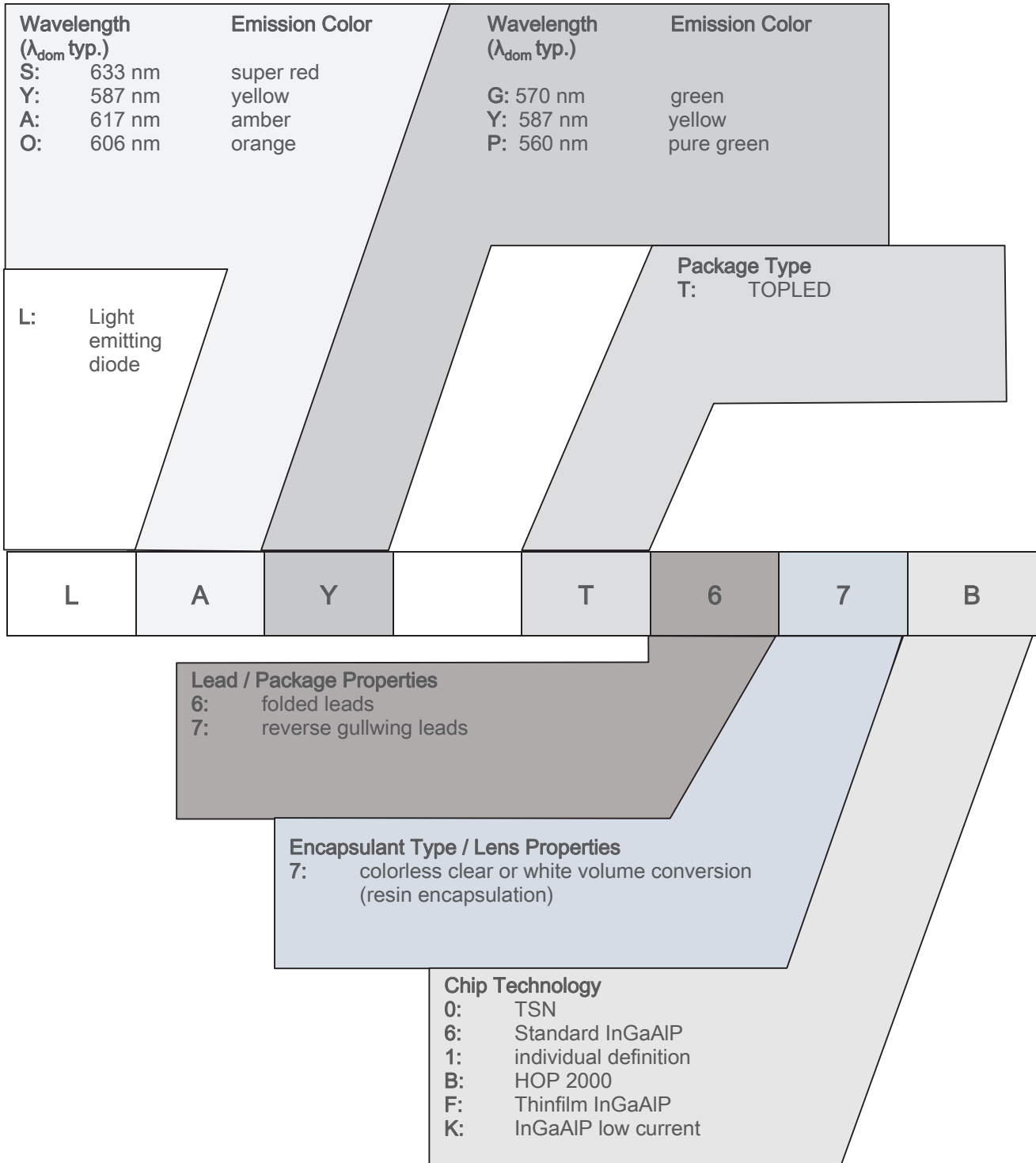

Notes

The evaluation of eye safety occurs according to the standard IEC 62471:2006 (photo biological safety of lamps and lamp systems). Within the risk grouping system of this IEC standard, the device specified in this data sheet fall into the class **exempt group (exposure time 10000 s)**. Under real circumstances (for exposure time, conditions of the eye pupils, observation distance), it is assumed that no endangerment to the eye exists from these devices. As a matter of principle, however, it should be mentioned that intense light sources have a high secondary exposure potential due to their blinding effect. When looking at bright light sources (e.g. headlights), temporary reduction in visual acuity and afterimages can occur, leading to irritation, annoyance, visual impairment, and even accidents, depending on the situation.

Subcomponents of this device contain, in addition to other substances, metal filled materials including silver. Metal filled materials can be affected by environments that contain traces of aggressive substances. Therefore, we recommend that customers minimize device exposure to aggressive substances during storage, production, and use. Devices that showed visible discoloration when tested using the described tests above did show no performance deviations within failure limits during the stated test duration. Respective failure limits are described in the IEC60810.

For further application related information please visit www.osram-os.com/appnotes

Disclaimer

Attention please!

The information describes the type of component and shall not be considered as assured characteristics. Terms of delivery and rights to change design reserved. Due to technical requirements components may contain dangerous substances.

For information on the types in question please contact our Sales Organization.

If printed or downloaded, please find the latest version on our website.

Packing

Please use the recycling operators known to you. We can also help you – get in touch with your nearest sales office. By agreement we will take packing material back, if it is sorted. You must bear the costs of transport. For packing material that is returned to us unsorted or which we are not obliged to accept, we shall have to invoice you for any costs incurred.

Product and functional safety devices/applications or medical devices/applications

Our components are not developed, constructed or tested for the application as safety relevant component or for the application in medical devices.

Our products are not qualified at module and system level for such application.

In case buyer – or customer supplied by buyer – considers using our components in product safety devices/ applications or medical devices/applications, buyer and/or customer has to inform our local sales partner immediately and we and buyer and /or customer will analyze and coordinate the customer-specific request between us and buyer and/or customer.

Glossary

- 1) **Brightness:** Brightness groups are tested at a current pulse duration of 25 ms and a tolerance of $\pm 11\%$.
- 2) **Reverse Operation:** This product is intended to be operated applying a forward current within the specified range. Applying any continuous reverse bias or forward bias below the voltage range of light emission shall be avoided because it may cause migration which can change the electro-optical characteristics or damage the LED.
- 3) **Wavelength:** Wavelengths are tested at a current pulse duration of 25 ms and a tolerance of ± 1 nm.
- 4) **Forward Voltage:** Forward voltages are tested at a current pulse duration of 1 ms and a tolerance of ± 0.1 V.
- 5) **Thermal Resistance:** $R_{th\ max}$ is based on statistic values (6σ).
- 6) **Thermal Resistance:** R_{thJA} results from mounting on PC board FR 4 (pad size 16 mm² per pad)
- 7) **Typical Values:** Due to the special conditions of the manufacturing processes of semiconductor devices, the typical data or calculated correlations of technical parameters can only reflect statistical figures. These do not necessarily correspond to the actual parameters of each single product, which could differ from the typical data and calculated correlations or the typical characteristic line. If requested, e.g. because of technical improvements, these typ. data will be changed without any further notice.
- 8) **Characteristic curve:** In the range where the line of the graph is broken, you must expect higher differences between single devices within one packing unit.
- 9) **Tolerance of Measure:** Unless otherwise noted in drawing, tolerances are specified with ± 0.1 and dimensions are specified in mm.
- 10) **Tape and Reel:** All dimensions and tolerances are specified acc. IEC 60286-3 and specified in mm.

Revision History

Version	Date	Change
1.1	2020-05-13	Ordering Information
1.2	2021-01-14	Features
1.3	2022-05-10	Maximum Ratings Characteristics Electro - Optical Characteristics (Diagrams) Derating (Diagrams) New Layout



EU RoHS and China RoHS compliant product

此产品符合欧盟 RoHS 指令的要求；
按照中国的相关法规和标准，
不含有毒有害物质或元素。

Published by ams-OSRAM AG

Tobelbader Strasse 30, 8141 Premstaetten, Austria

Phone +43 3136 500-0

ams-osram.com

© All rights reserved

am 

OSRAM