

Specification

- Part No.** : **LPDA.02**
- Description** : LPDA.02 Engager External Wide Band Directional LPDA Antenna
- Features** : Frequency: 698-3900MHz
Peak Gain: 7dBi
Dimensions: 230*330*32mm
Dimensions with Bracket: 230*420*105mm
Cable Length: 300mm
Connector: SMA(M)
RoHS & Reach Compliant



1. Introduction

The LPDA.02 Engager is a wide-band directional LPDA exterior antenna that operates within the 698-3900MHz frequency bands. It is an innovative and future proof solution, ideal for LTE 4G and 2G/3G networks as well as 2.4GHz Wi-Fi.

This wideband design eliminates the need to purchase different antennas for each frequency which simplifies installations since the same antenna can be used for a wide array of wireless applications where extensive coverage is desired.

The LPDA.02 has a 70° beam width in both orthogonal planes. The ABS external housing is robust, UV resistant and IP65 waterproof ensuring it is completely weatherproof and sealed. For various mounting options, it is supplied with tilt and swivel wall and pole brackets. The LPDA.02 has been tested for wind resistance up to 200 km/h

LTE 4G and 2.4GHz Wi-Fi applications demand high speed data uplink and downlink and where required, two LPDA.02 antennas can be mounted in space at 90° to create a MIMO arrangement.

Cable type, length and connectors are customizable for large order volumes. Please contact your regional Taoglas sales office for support.

2. Specification

ELECTRICAL						
Operation Frequency (MHz)	LTE 700 GSM 900	DCS PCS	UMTS HSPA	Wi-Fi	LTE 2600	LTE 3500
	698-960	1710~1990	1755~2170	2400~2500	2500~2700	3400~3600
Return Loss (dB)	-10	-10	-10	-10	-10	-6
Efficiency (%)	67	64	67	58	60	50
Peak Gain (dBi)	7	6	6	5.5	5	5
Max VSWR	2:1	2:1	2:1	2:1	2:1	3:1
Radiation Properties	Directional					
Polarization	Linear					
Impedance (Ohms)	50Ω					
Max input Power	10W					
MECHANICAL						
Dimension	230*330*32mm without Bracket 230*420*105mm with Bracket					
Material	Body: PC Coated UV Stabilized ABS Bracket: Black Powder Coated 316 Stainless					
Connector	SMA (M)					
Weight	819g With Bracket 430g Without Bracket					
Cable Type	300mm RG-174					
Waterproof Rating	IP65					
ENVIRONMENTAL						
Operation Temperature	-40°C to 85°C					
Storage Temperature	-40°C to 105°C					
Humidity	Non-condensing 65°C 95% RH					
Wind Resistance	Up to 200km/h					

3. Antenna Characteristics

3.1 Set up

Return Loss and VSWR Measurement

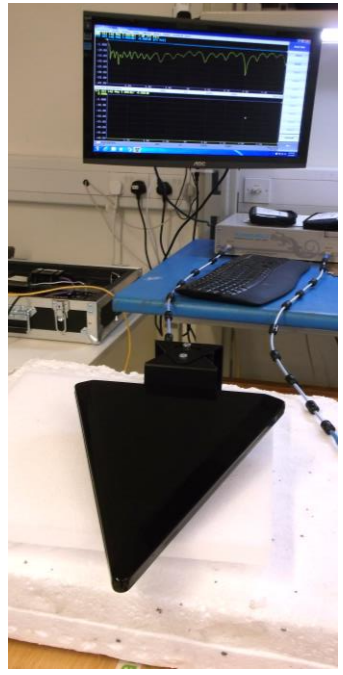

Efficiency and Gain Measurement

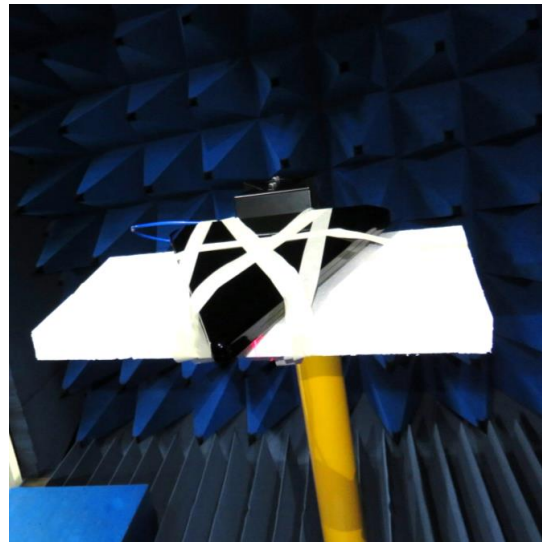

3.2 Return Loss

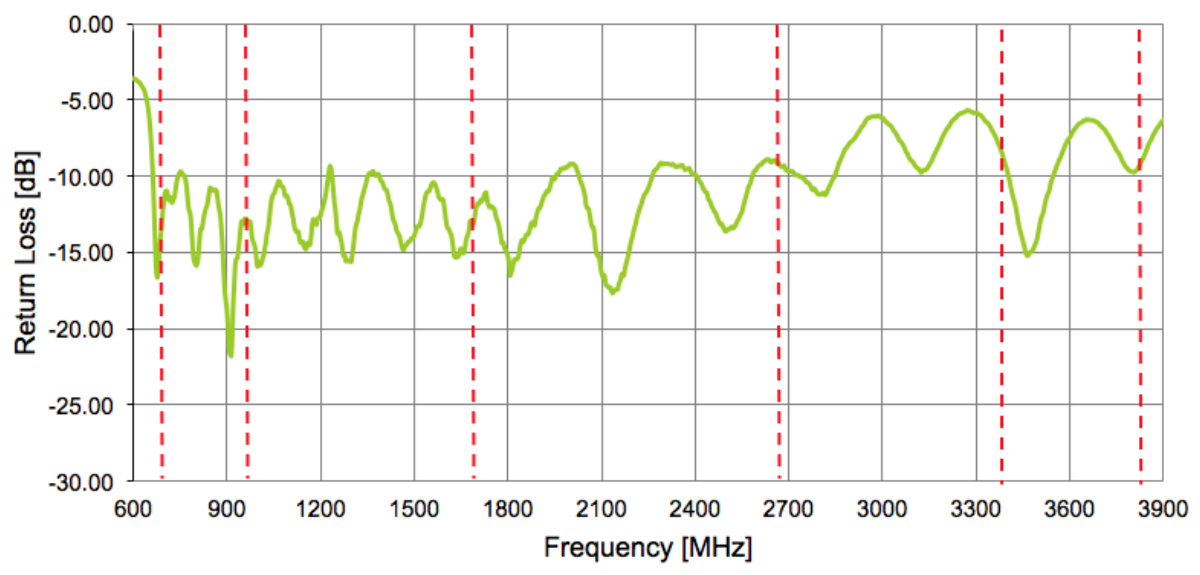



3.3 VSWR

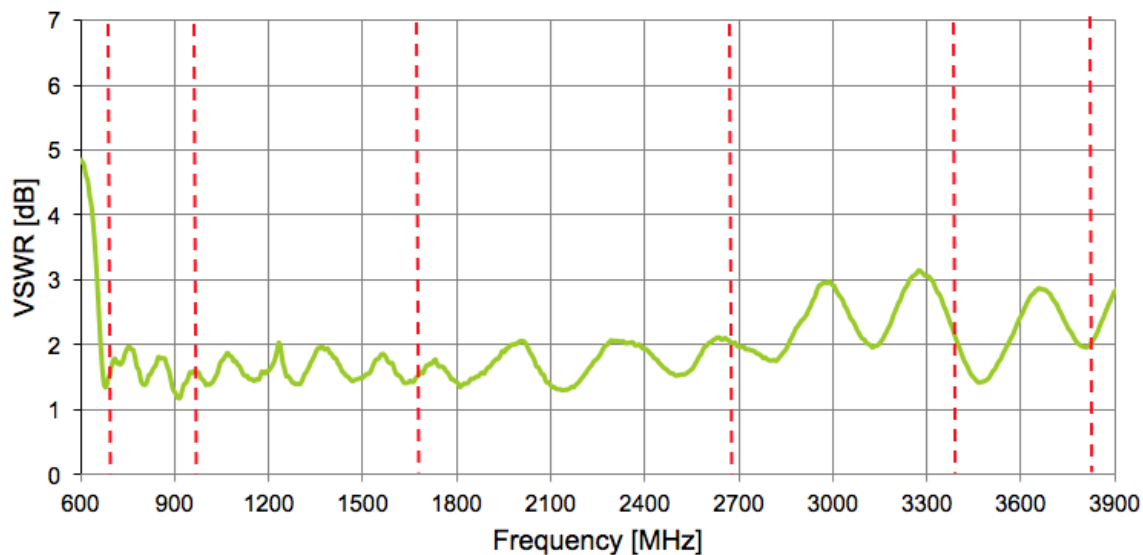

3.4 Efficiency

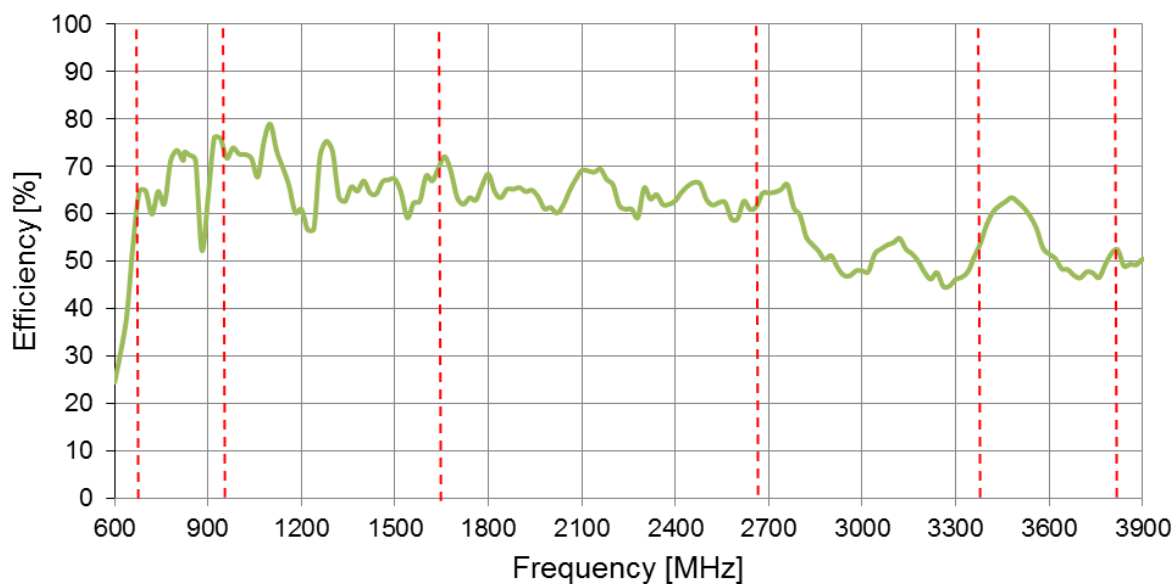

3.5 Peak Gain

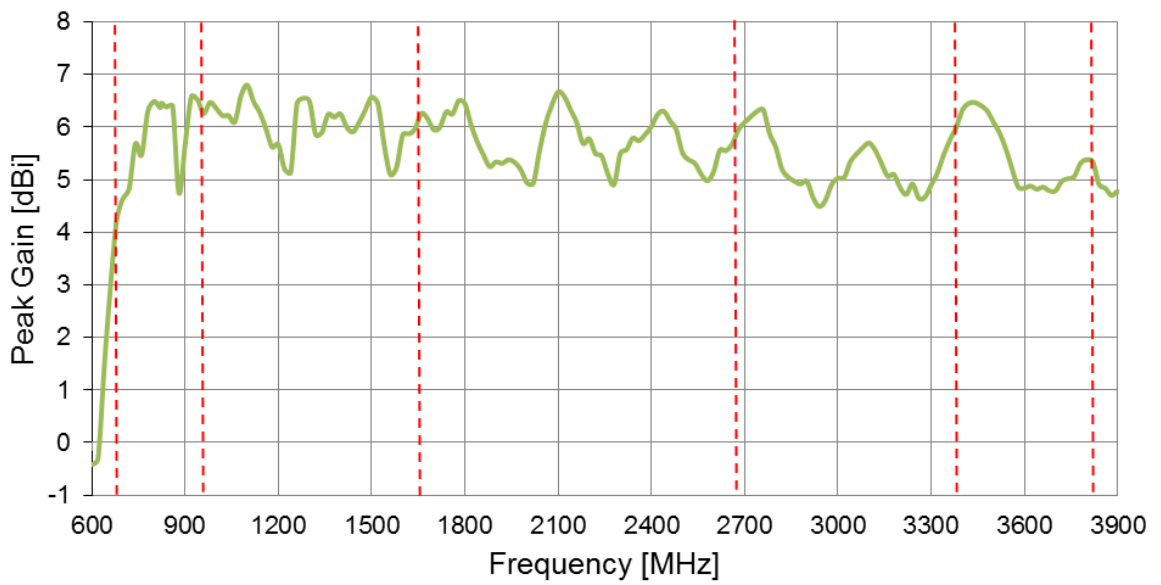

3.6 Average Gain

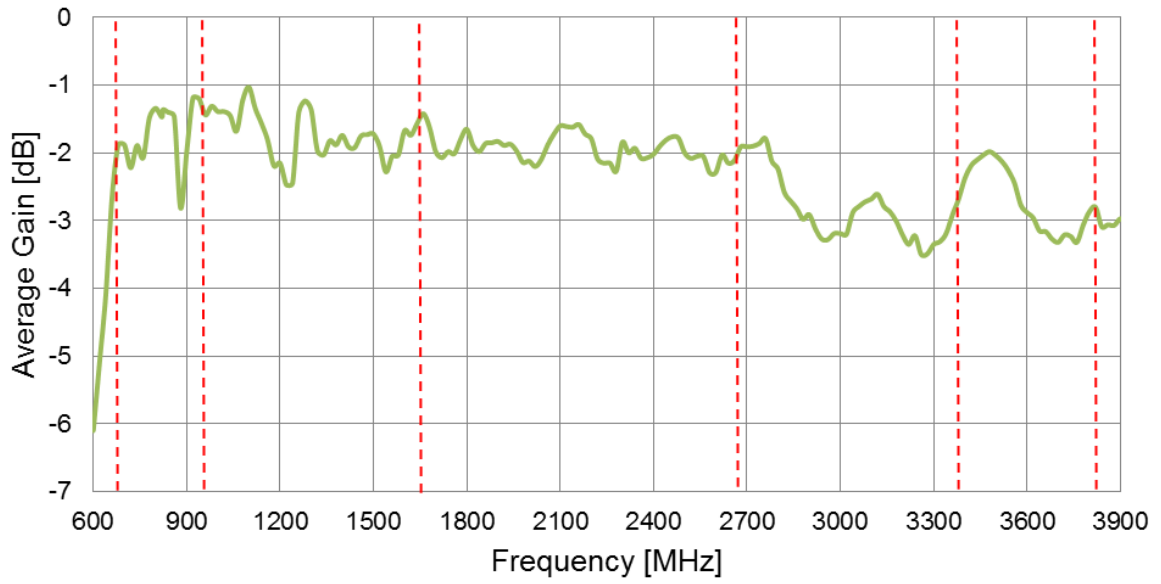

4. Antenna Radiation Pattern

4.1 Measurement Setup

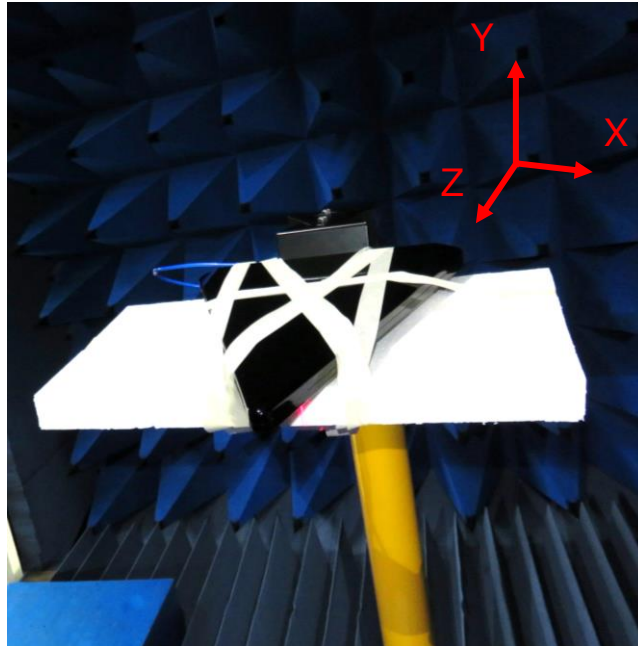



4.2 2D Radiation Pattern

XZ Plane

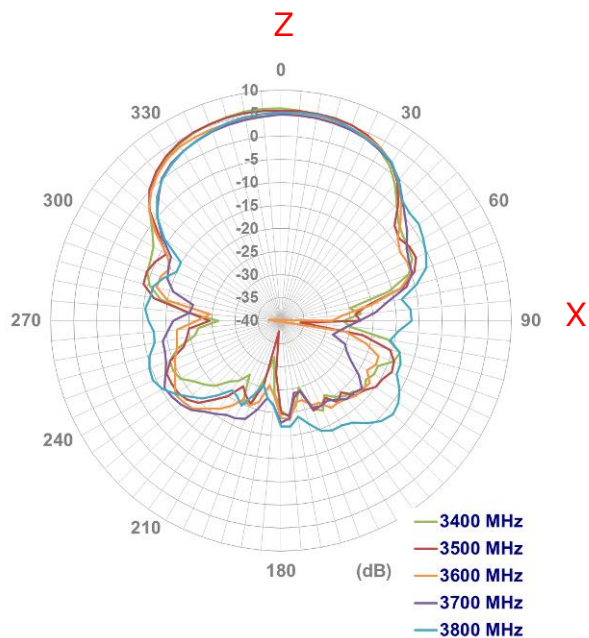
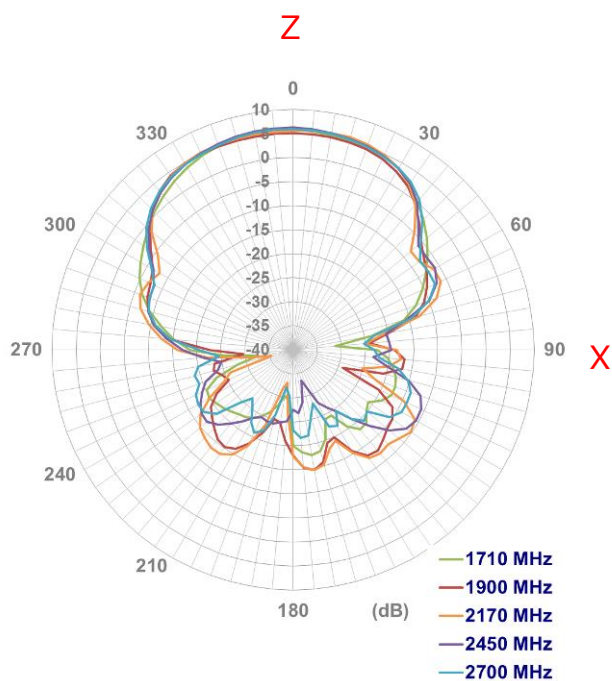
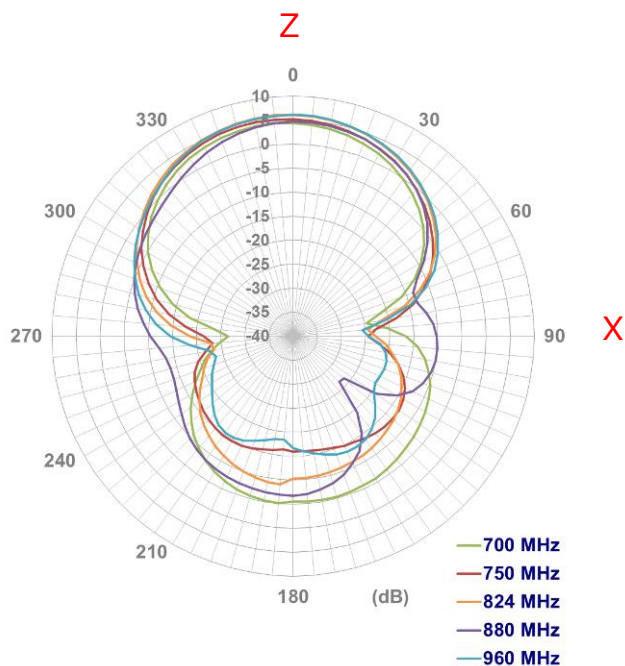



YZ Plane

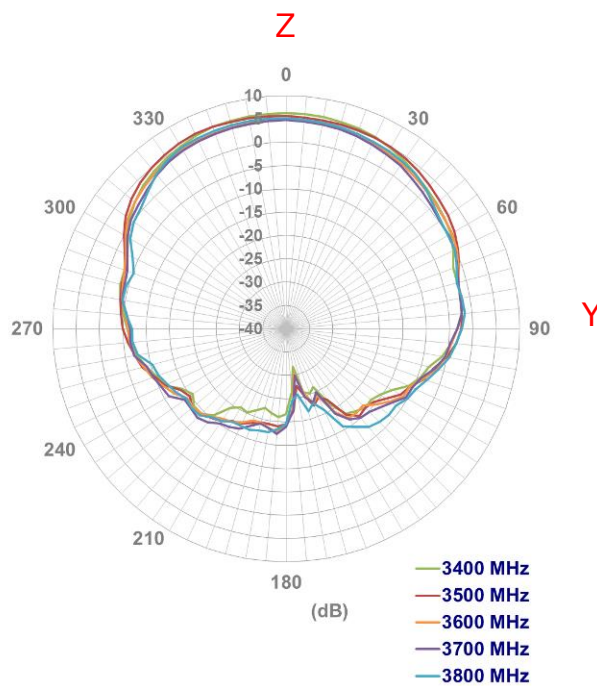
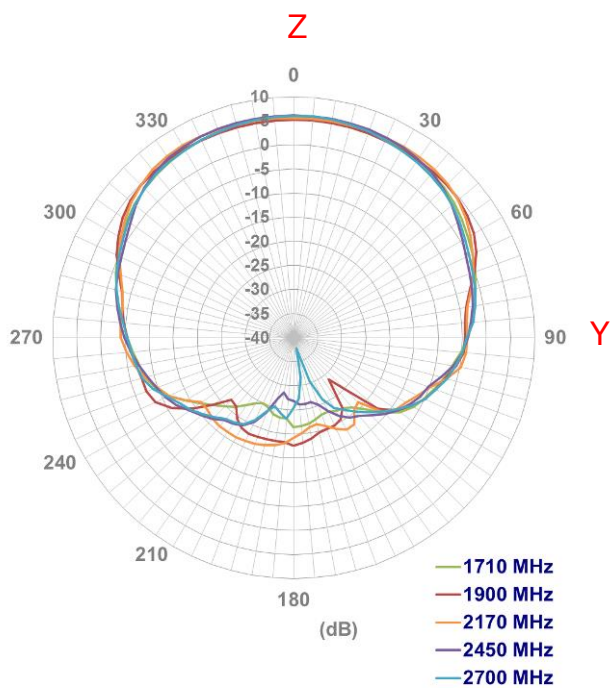
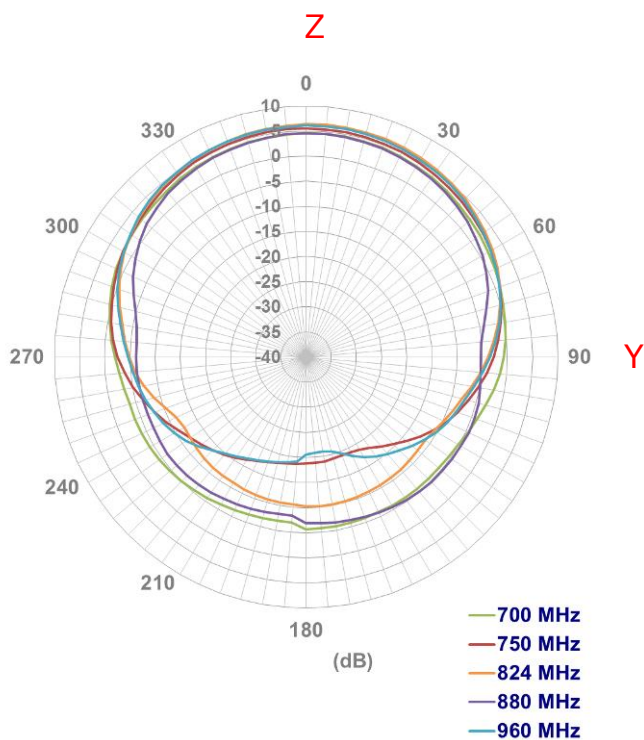



XZ Plane

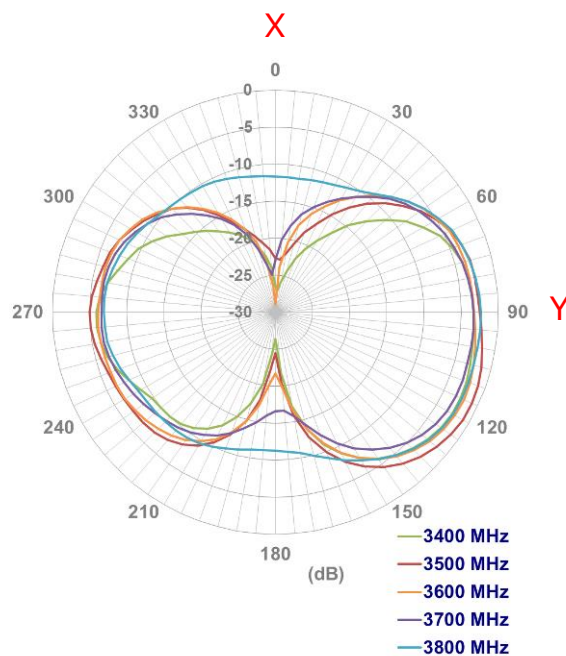
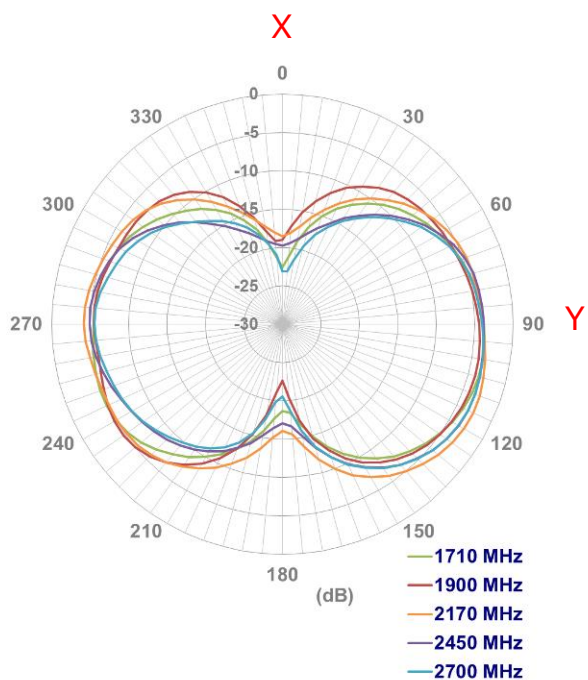
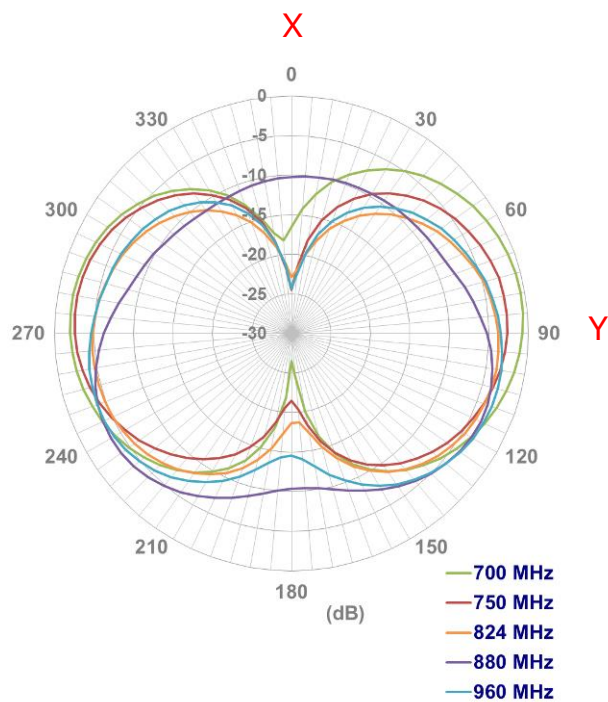



4.3 3D Radiation Pattern

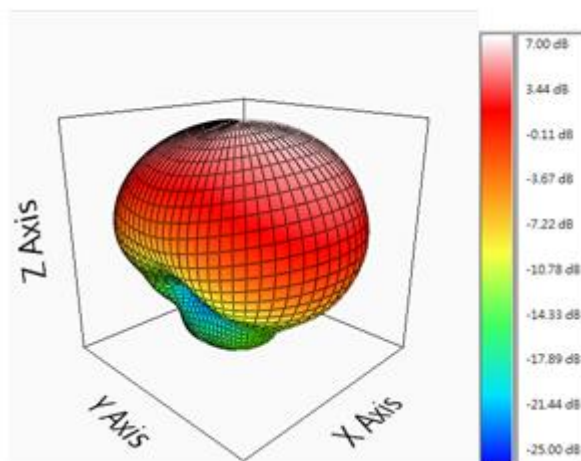

824MHz

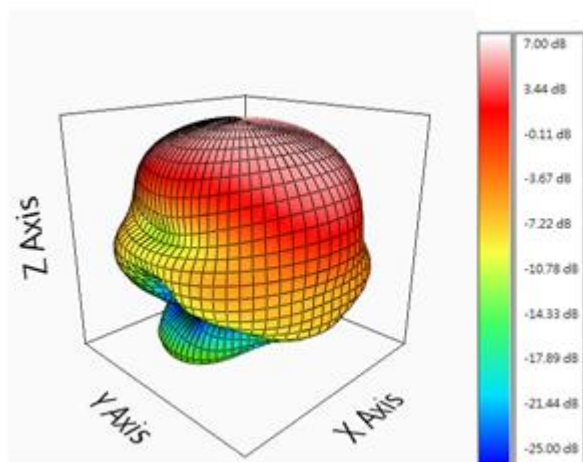

2170MHz

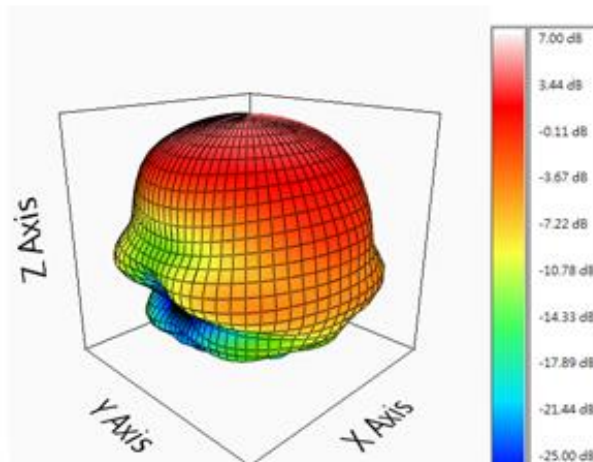

3600MHz



5. Mechanical Drawing (Unit: mm)

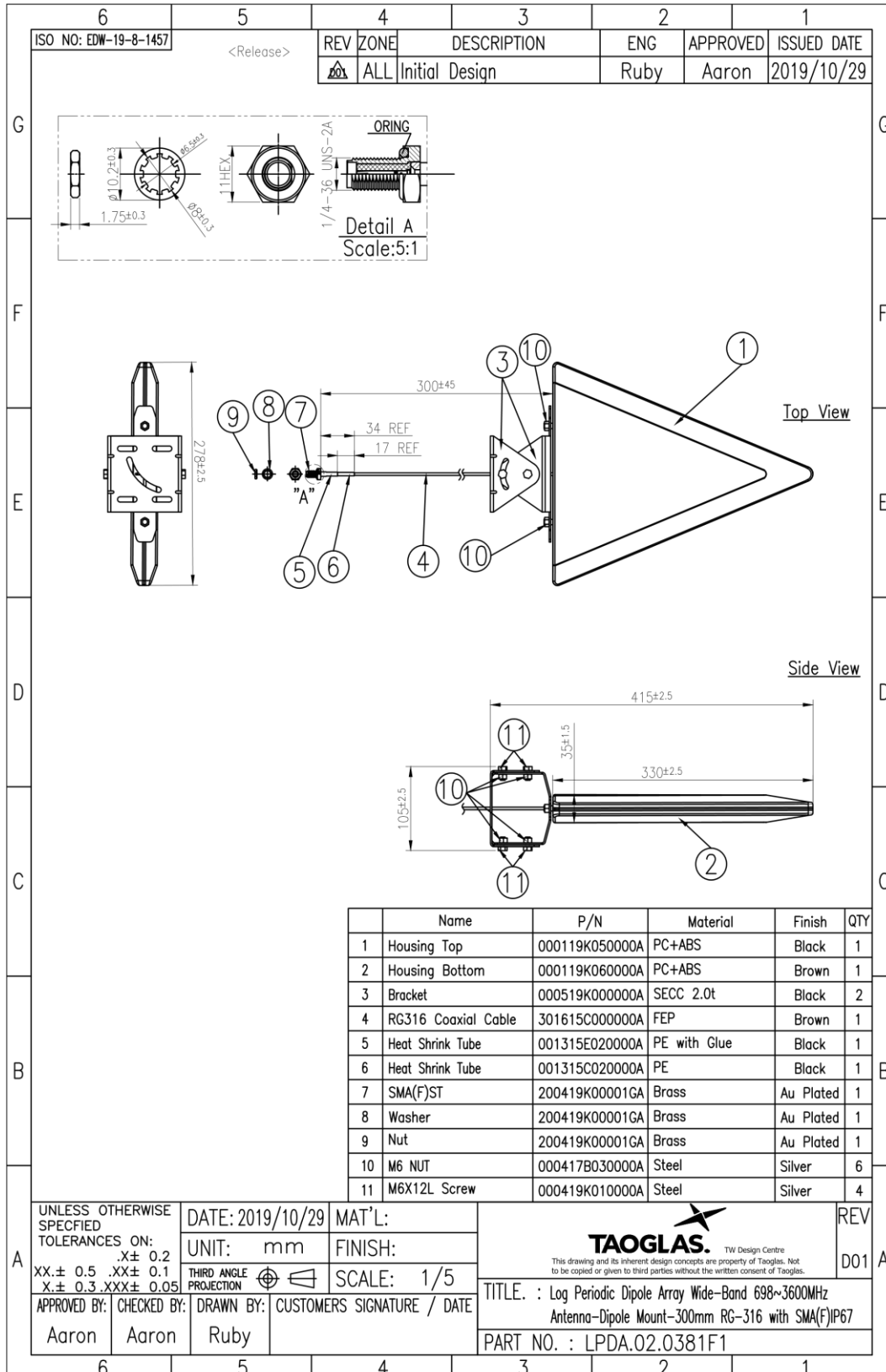

6. Packaging

Currently under development.

Taoglas makes no warranties based on the accuracy or completeness of the contents of this document and reserves the right to make changes to specifications and product descriptions at any time without notice. Taoglas reserves all rights to this document and the information contained herein.

Reproduction, use or disclosure to third parties without express permission is strictly prohibited.

© Taoglas