

**200 mA LOAD SWITCH FEATURING PRE-BIASED PNP TRANSISTOR AND N-MOSFET WITH PULL DOWN RESISTOR**

**General Description**

- LMN200B01 is best suited for applications where the load needs to be turned on and off using control circuits like micro-controllers, comparators, etc., particularly at a point of load. It features a discrete pass transistor with stable  $V_{CE(SAT)}$  which does not depend on the input voltage and can support continuous maximum current of 200 mA. It also contains a discrete N-MOSFET that can be used as control. This N-MOSFET also has a built-in pull down resistor at its gate. The component can be used as a part of a circuit or as a stand alone discrete device.

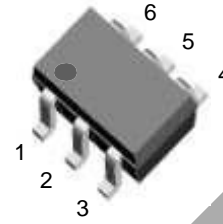

Fig. 1: SOT-26

**Features**

- Voltage Controlled Small Signal Switch
- N-MOSFET with Gate Pull-Down Resistor
- Surface Mount Package
- Ideally Suited for Automated Assembly Processes
- Lead Free By Design/ROHS Compliant (Note 1)
- "Green" Device (Note 2)

**Mechanical Data**

- Case: SOT-26
- Case Material: Molded Plastic, "Green" Molding
- Compound. UL Flammability Classification Rating 94V-0
- Moisture sensitivity: Level 1 per J-STD-020C
- Terminal Connections: See Diagram
- Terminals: Finish - Matte Tin annealed over Copper leadframe. Solderable per MIL-STD-202, Method 208
- Marking & Type Code Information: See Last Page
- Ordering Information: See Last Page
- Weight: 0.016 grams (approximate)

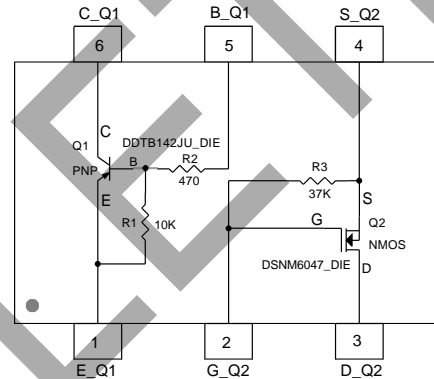

Fig. 2 Schematic and Pin Configuration

Sub-Components	Reference	Device Type	R1 (NOM)	R2 (NOM)	R3 (NOM)	Figure
DDTB142JU_DIE	Q1	PNP Transistor	10K	470	—	2
DSNM6047_DIE	Q2	N-MOSFET	—	—	37K	2

**Maximum Ratings, Total Device @  $T_A = 25^\circ\text{C}$  unless otherwise specified**

Characteristic	Symbol	Value	Unit
Power Dissipation (Note 3)	$P_d$	300	mW
Power Derating Factor above $125^\circ\text{C}$	$P_{der}$	2.4	mW/ $^\circ\text{C}$
Output Current	$I_{out}$	200	mA

**Thermal Characteristics**

Characteristic	Symbol	Value	Unit
Junction Operation and Storage Temperature Range	$T_j, T_{stg}$	-55 to +150	$^\circ\text{C}$
Thermal Resistance, Junction to Ambient Air (Note3) (Equivalent to one heated junction of PNP transistor)	$R_{\theta JA}$	417	$^\circ\text{C/W}$

- Notes:
- No purposefully added lead.
  - Diodes Inc.'s "Green" policy can be found on our website at [http://www.diodes.com/products/lead\\_free/index.php](http://www.diodes.com/products/lead_free/index.php).
  - Device mounted on FR-4 PCB, 1 inch x 0.85 inch x 0.062 inch; pad layout as shown on Diodes Inc. suggested pad layout document AP02001, which can be found on our website at <http://www.diodes.com/datasheets/ap02001.pdf>.

OBSOLETE - PART DISCONTINUED

**Maximum Ratings:**
**Sub-Component Device: Pre-Biased PNP Transistor (Q1)** @  $T_A = 25^\circ\text{C}$  unless otherwise specified

Characteristic	Symbol	Value	Unit
Collector-Base Voltage	$V_{CBO}$	-50	V
Collector-Emitter Voltage	$V_{CEO}$	-50	V
Supply Voltage	$V_{cc}$	-50	V
Input Voltage	$V_{in}$	+5 to -6	V
Output Current	$I_C$	-200	mA

**Sub-Component Device:**
**N-MOSFET with Gate Pull-Down Resistor (Q2)** @  $T_A = 25^\circ\text{C}$  unless otherwise specified

Characteristic	Symbol	Value	Unit
Drain-Source Voltage	$V_{DSS}$	60	V
Drain Gate Voltage ( $R_{GS} \leq 1M\Omega$ )	$V_{DGR}$	60	V
Gate-Source Voltage	$V_{GSS}$	Continuous	+/-20
		Pulsed ( $t_p < 50 \mu\text{s}$ )	+/-40
Drain Current (Page 1: Note 3)	$I_D$	Continuous ( $V_{GS} = 10\text{V}$ )	115
		Pulsed ( $t_p < 10 \mu\text{s}$ , Duty Cycle < 1%)	800
Continuous Source Current	$I_S$	115	mA

**OBSOLETE - PART DISCONTINUED**
**OBSOLETE**

**Electrical Characteristics: Pre-Biased PNP Transistor (Q1) @  $T_A = 25^\circ\text{C}$  unless otherwise specified**

Characteristic	Symbol	Min	Typ	Max	Unit	Test Condition
<b>OFF CHARACTERISTICS</b>						
Collector-Base Cut Off Current	$I_{CBO}$	—	—	-100	nA	$V_{CB} = -50\text{V}, I_E = 0$
Collector-Emitter Cut Off Current	$I_{CEO}$	—	—	-500	nA	$V_{CE} = -50\text{V}, I_B = 0$
Emitter-Base Cut Off Current	$I_{EBO}$	—	-0.5	-1	mA	$V_{EB} = -5\text{V}, I_C = 0$
Emitter-Base Cut Off Current	$V_{(BR)CBO}$	-50	—	—	V	$I_C = -10\mu\text{A}, I_E = 0$
Collector-Base Breakdown Voltage	$V_{(BR)CEO}$	-50	—	—	V	$I_C = -2\text{mA}, I_B = 0$
Collector-Emitter Breakdown Voltage	$V_{I(OFF)}$	—	-0.55	-0.3	V	$V_{CE} = -5\text{V}, I_C = -100\mu\text{A}$
Output Voltage	$V_{OH}$	-4.9	—	—	V	$V_{CC} = -5\text{V}, V_B = -0.05\text{V}, R_L = 1\text{K}$
Output Current (leakage current same as $I_{CEO}$ )	$I_{O(OFF)}$	—	—	-500	nA	$V_{CC} = -50\text{V}, V_I = 0\text{V}$
<b>ON CHARACTERISTICS</b>						
Collector-Emitter Saturation Voltage	$V_{CE(SAT)}$	—	—	-0.15	V	$I_C = -10\text{mA}, I_B = -0.5\text{mA}$
		—	—	-0.2	V	$I_C = -50\text{mA}, I_B = -5\text{mA}$
		—	—	-0.2	V	$I_C = -20\text{mA}, I_B = -1\text{mA}$
		—	—	-0.25	V	$I_C = -100\text{mA}, I_B = -10\text{mA}$
		—	—	-0.25	V	$I_C = -200\text{mA}, I_B = -10\text{mA}$
		—	—	-0.3	V	$I_C = -200\text{mA}, I_B = -20\text{mA}$
Equivalent on-resistance*	$R_{CE(SAT)}$	—	—	1.5	$\Omega$	$I_C = -200\text{mA}, I_B = -10\text{mA}$
DC Current Gain	$h_{FE}$	60	150	—	—	$V_{CE} = -5\text{V}, I_C = -20\text{mA}$
		60	215	—	—	$V_{CE} = -5\text{V}, I_C = -50\text{mA}$
		60	245	—	—	$V_{CE} = -5\text{V}, I_C = -100\text{mA}$
		60	250	—	—	$V_{CE} = -5\text{V}, I_C = -200\text{mA}$
Input On Voltage	$V_{I(ON)}$	-2.45	-0.7	—	V	$V_O = -0.3\text{V}, I_C = -2\text{mA}$
Output Voltage (equivalent to $V_{CE(SAT)}$ or $V_{O(on)}$ )	$V_{OL}$	—	-0.065	-0.15	V	$V_{CC} = -5\text{V}, V_B = -2.5\text{V}, I_O/I_I = -50\text{mA} / -2.5\text{mA}$
Input Current	$I_i$	—	-9.2	-13	mA	$V_i = -5\text{V}$
Base-Emitter Turn-on Voltage	$V_{BE(ON)}$	—	-1.125	-1.3	V	$V_{CE} = -5\text{V}, I_C = -200\text{mA}$
Base-Emitter Saturation Voltage	$V_{BE(SAT)}$	—	-3.2	-3.6	V	$I_C = -50\text{mA}, I_B = -5\text{mA}$
		—	-4.55	-5.5	V	$I_C = -80\text{mA}, I_B = -8\text{mA}$
Input Resistor (Base), +/- 30%	R2	—	0.47	—	$\text{K}\Omega$	—
Pull-up Resistor (Base to $V_{CC}$ supply), +/- 30%	R1	—	10	—	$\text{K}\Omega$	—
Resistor Ratio (Input Resistor/Pullup resistor), +/- 20%	R1/R2	—	21	—	—	—
<b>SMALL SIGNAL CHARACTERISTICS</b>						
Transition Frequency (gain bandwidth product)	$f_T$	—	200	—	MHz	$V_{CE} = -10\text{V}, I_E = -5\text{mA}, f = 100\text{MHz}$
Collector capacitance, ( $C_{cbo}$ -Output Capacitance)	$C_C$	—	20	—	pF	$V_{CB} = -10\text{V}, I_E = 0\text{A}, f = 1\text{MHz}$

\* Pulse Test: Pulse width,  $t_p < 300\mu\text{s}$ , Duty Cycle,  $d < 0.02$ .

**Electrical Characteristics:**

**N-MOSFET with Gate Pull-Down Resistor (Q2) @ T<sub>A</sub> = 25°C unless otherwise specified**

**OBSOLETE - PART DISCONTINUED**

Characteristic	Symbol	Min	Typ	Max	Unit	Test Condition
<b>OFF CHARACTERISTICS (Note 4)</b>						
Drain-Source Breakdown Voltage, BVDSS	V <sub>(BR)DSS</sub>	60	—	—	V	V <sub>GS</sub> = 0V, I <sub>D</sub> = 10μA
Zero Gate Voltage Drain Current (Drain Leakage Current)	I <sub>DSS</sub>	—	—	1	μA	V <sub>GS</sub> = 0V, V <sub>DS</sub> = 60V
Gate-Body Leakage Current, Forward	I <sub>GSSF</sub>	—	—	0.95	mA	V <sub>GS</sub> = 20V, V <sub>DS</sub> = 0V
Gate-Body Leakage Current, Reverse	I <sub>GSSR</sub>	—	—	-0.95	mA	V <sub>GS</sub> = -20V, V <sub>DS</sub> = 0V
<b>ON CHARACTERISTICS (Note 4)</b>						
Gate Source Threshold Voltage (Control Supply Voltage)	V <sub>GS(th)</sub>	1	1.86	2.2	V	V <sub>DS</sub> = V <sub>GS</sub> , I <sub>D</sub> = 0.25mA
Static Drain-Source On-State Voltage	V <sub>DS(on)</sub>	—	0.08	1.5	V	V <sub>GS</sub> = 5V, I <sub>D</sub> = 50mA
		—	0.15	3.75		V <sub>GS</sub> = 10V, I <sub>D</sub> = 115mA
On-State Drain Current	I <sub>D(on)</sub>	500	—	—	mA	V <sub>GS</sub> = 10V, V <sub>DS</sub> ≥ 2 V <sub>DS(on)</sub>
Static Drain-Source On Resistance	R <sub>DS(on)</sub>	—	1.55	3	Ω	V <sub>GS</sub> = 5V, I <sub>D</sub> = 50mA
		—	1.4	2		V <sub>GS</sub> = 10V, I <sub>D</sub> = 500mA
Forward Transconductance	g <sub>FS</sub>	80	240	—	mS	V <sub>DS</sub> ≥ 2 V <sub>DS(on)</sub> , I <sub>D</sub> = 115 mA
		80	350	—		V <sub>DS</sub> ≥ 2 V <sub>DS(on)</sub> , I <sub>D</sub> = 200 mA
Gate Pull-Down Resistor, +/- 30%	R3	—	37	—	KΩ	—
<b>DYNAMIC CHARACTERISTICS</b>						
Input Capacitance	C <sub>iss</sub>	—	—	50	pF	V <sub>DS</sub> = -25V, V <sub>GS</sub> = 0V, f = 1MHz
Output Capacitance	C <sub>oss</sub>	—	—	25	pF	
Reverse Transfer Capacitance	C <sub>rss</sub>	—	—	5	pF	
<b>SWITCHING CHARACTERISTICS*</b>						
Turn-On Delay Time	t <sub>d(on)</sub>	—	—	20	ns	V <sub>DD</sub> = 30V, V <sub>GS</sub> = 10V, I <sub>D</sub> = 200mA, R <sub>G</sub> = 25Ω, R <sub>L</sub> = 150Ω
Turn-Off Delay Time	t <sub>d(off)</sub>	—	—	40	ns	
<b>SOURCE-DRAIN (BODY) DIODE CHARACTERISTICS AND MAXIMUM RATINGS</b>						
Drain-Source Diode Forward On-Voltage	V <sub>SD</sub>	—	0.88	1.5	V	V <sub>GS</sub> = 0V, I <sub>S</sub> = 115 mA*
Maximum Continuous Drain-Source Diode Forward Current (Reverse Drain Current)	I <sub>S</sub>	—	—	115	mA	—
Maximum Pulsed Drain-Source Diode Forward Current	I <sub>SM</sub>	—	—	800	mA	—

\* Pulse Test: Pulse width, t<sub>p</sub> < 300 μs, Duty Cycle, d <= 0.02.

Notes: 4. Short duration test pulse used to minimize self-heating effect.

Typical Characteristics

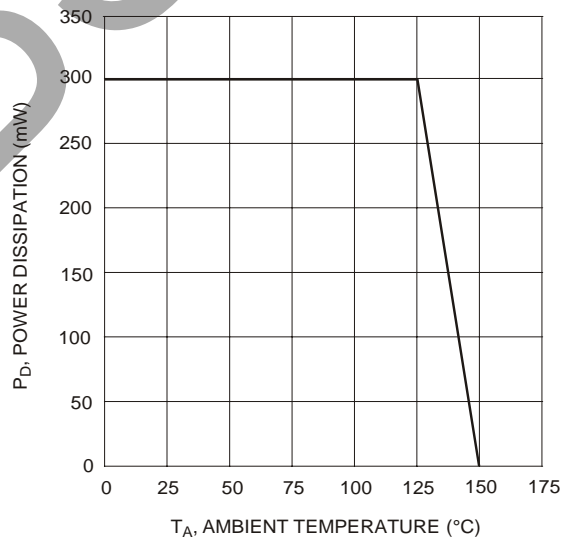

Fig. 3. Max Power Dissipation vs Ambient Temperature

## Typical Pre-Biased PNP Transistor (Q1) Characteristics

OBSOLETE - PART DISCONTINUED

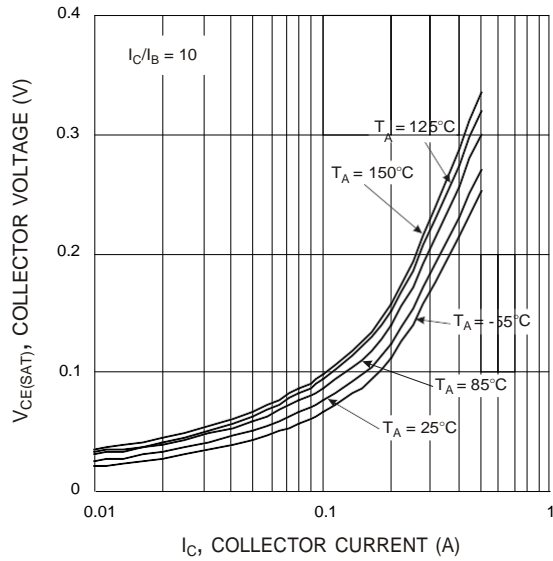

Fig. 4  $V_{CE(SAT)}$  vs.  $I_C$

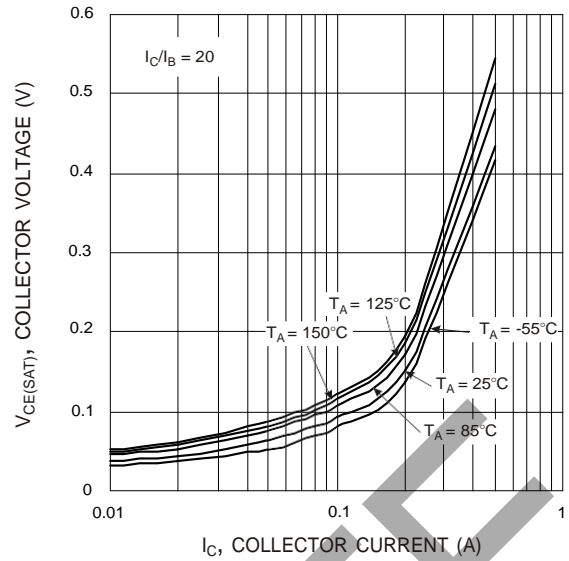

Fig. 5  $V_{CE(SAT)}$  vs.  $I_C$

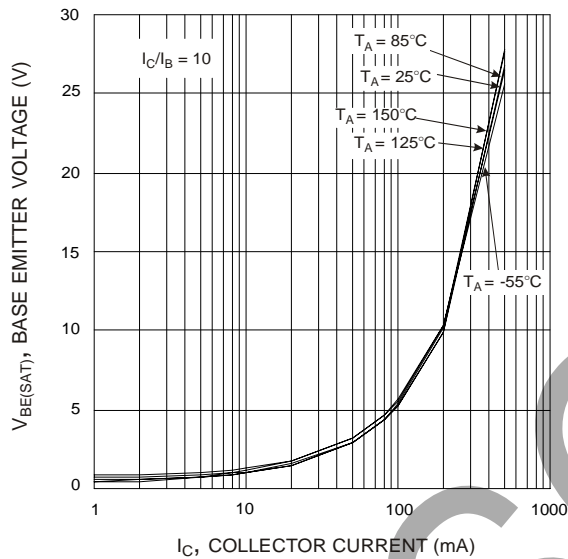

Fig. 6  $V_{BE(SAT)}$  vs.  $I_C$

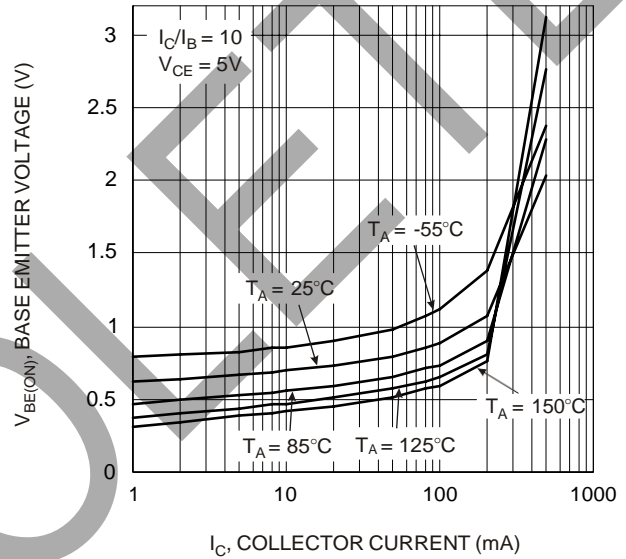

Fig. 7  $V_{BE(ON)}$  vs.  $I_C$

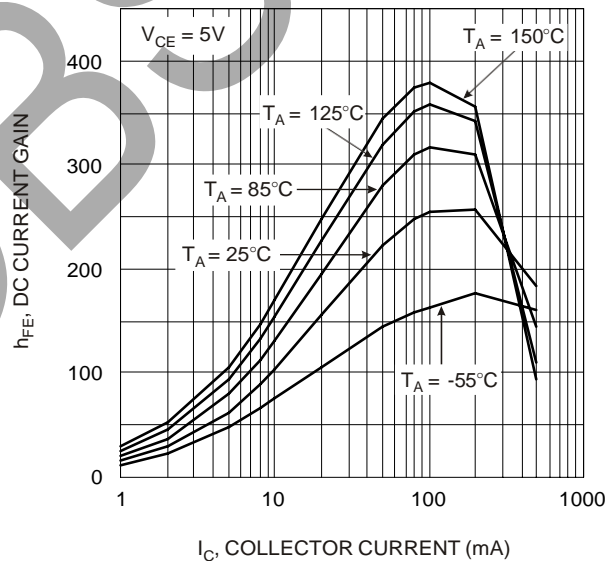
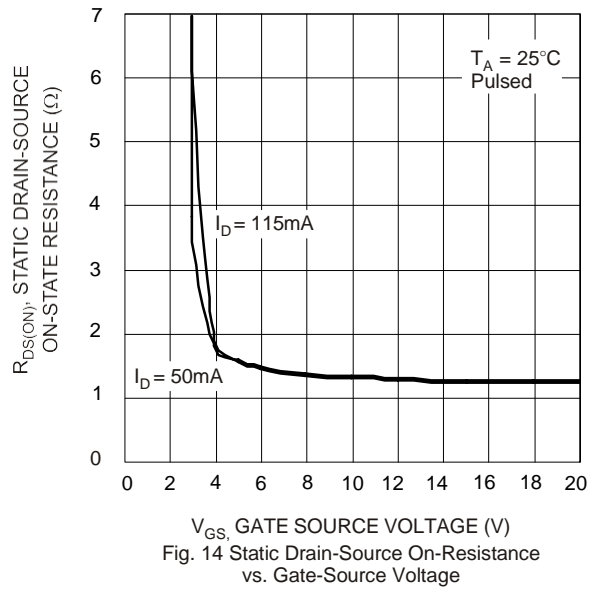
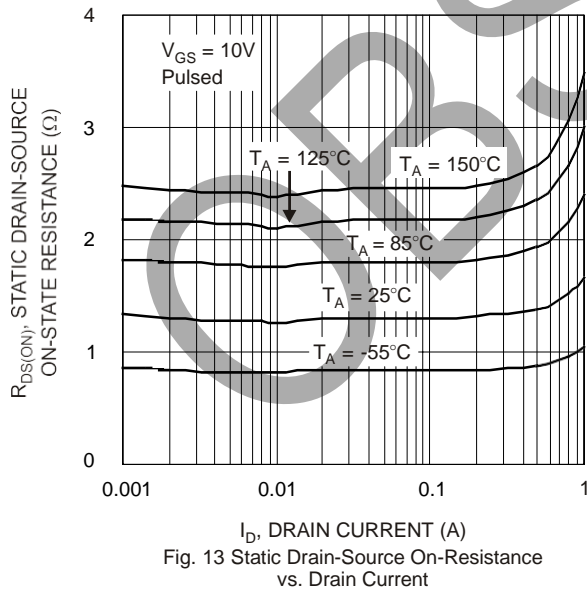
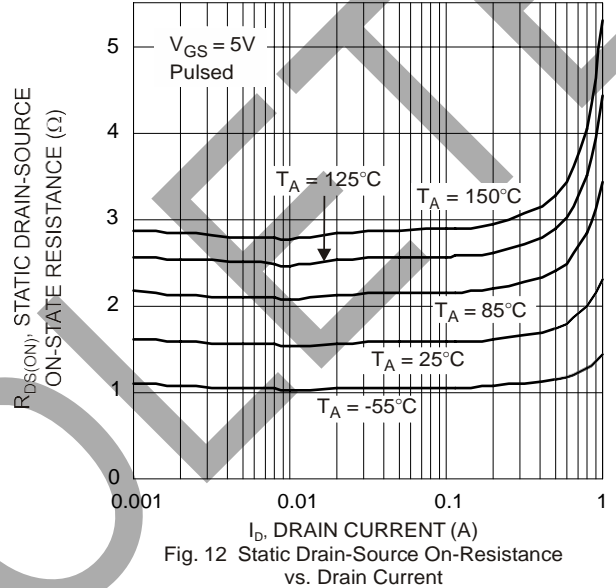
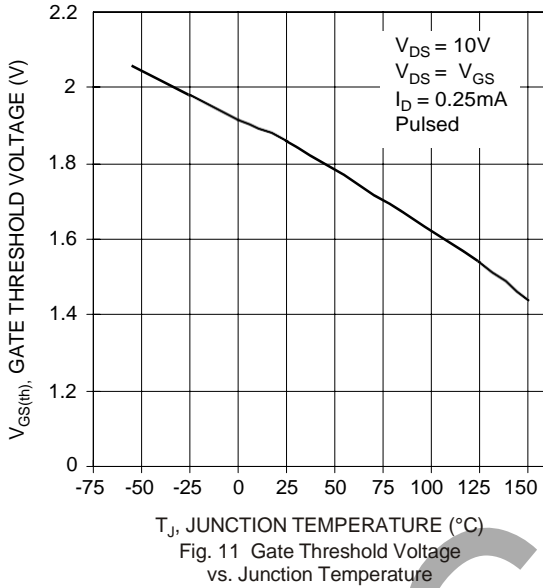
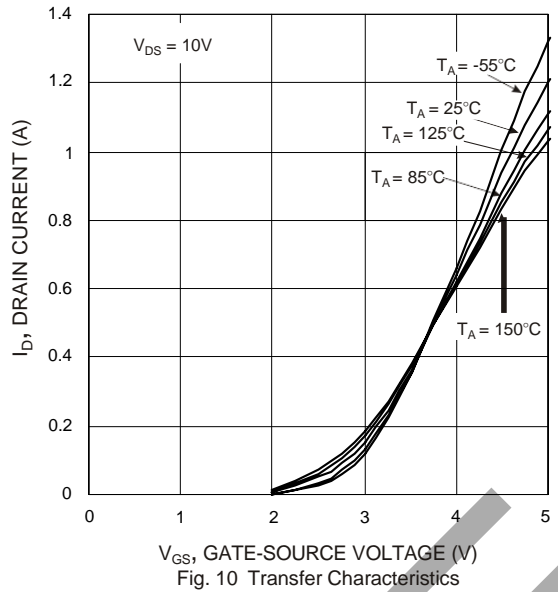
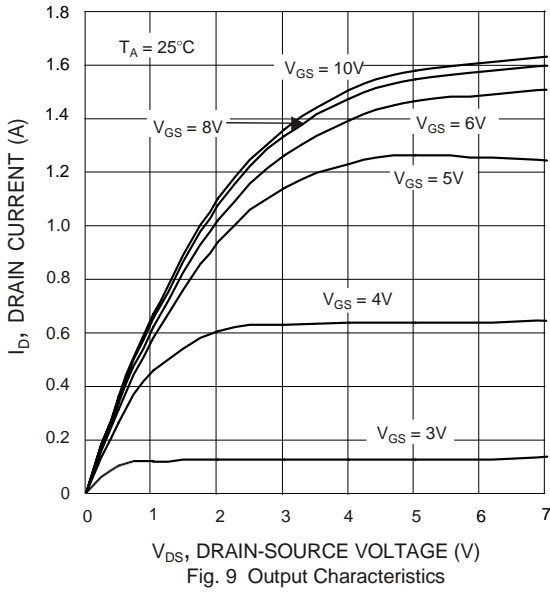

Fig. 8  $h_{FE}$  vs.  $I_C$



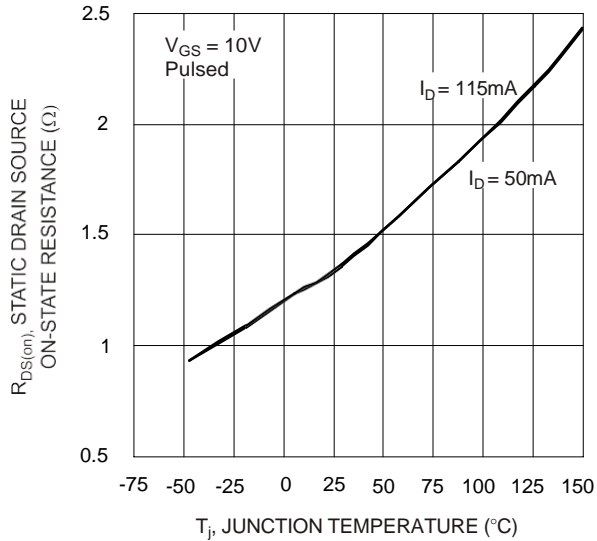

Fig. 15 Static Drain-Source On-State Resistance vs. Junction Temperature

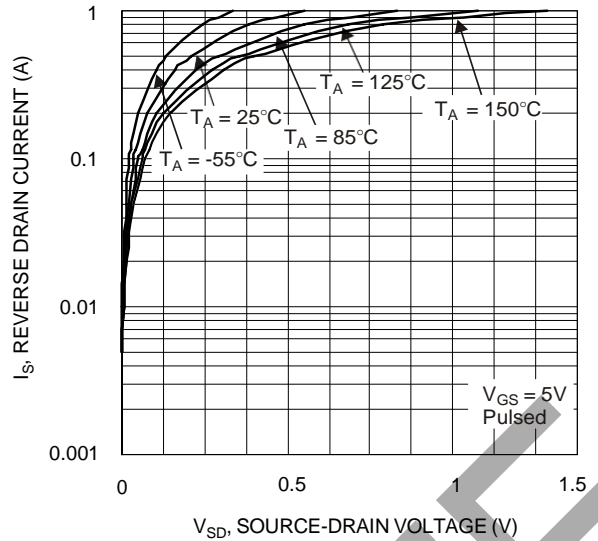

Fig. 16 Reverse Drain Current vs. Source-Drain Voltage

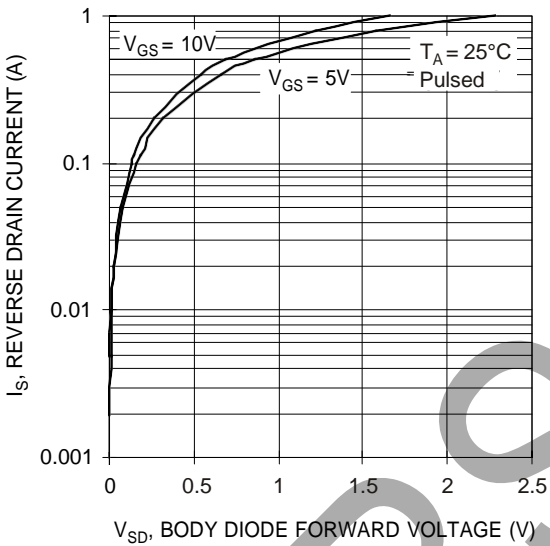

Fig. 17 Reverse Drain Current vs. Body Diode Forward Voltage

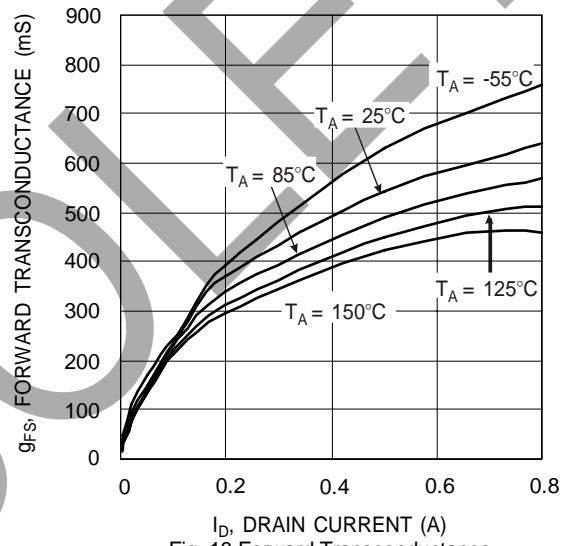

Fig. 18 Forward Transconductance vs. Drain Current ( $V_{DS} > I_D R_{DS(ON)}$ )

**Application Details**

- PNP Transistor (DDTB142JU) and N-MOSFET (DSNM6047) with gate pull-down resistor integrated as one in LMN200B01 can be used as a discrete entity for general purpose applications or as an integrated circuit to function as a Load Switch. When it is used as the latter as shown in Fig 19, various input voltage sources can be used as long as it does not exceed the maximum ratings of the device. These devices are designed to deliver continuous output load current up to a maximum of 200 mA. The MOSFET Switch draws no current, hence loading of control circuit is prevented. Care must be taken for higher levels of dissipation while designing for higher load conditions. These devices provide high power and also consume less space. The product mainly helps in optimizing power usage, thereby conserving battery life in a controlled load system like portable battery powered applications. (Please see Fig. 20 for one example of a typical application circuit used in conjunction with voltage regulator as a part of a power management system)

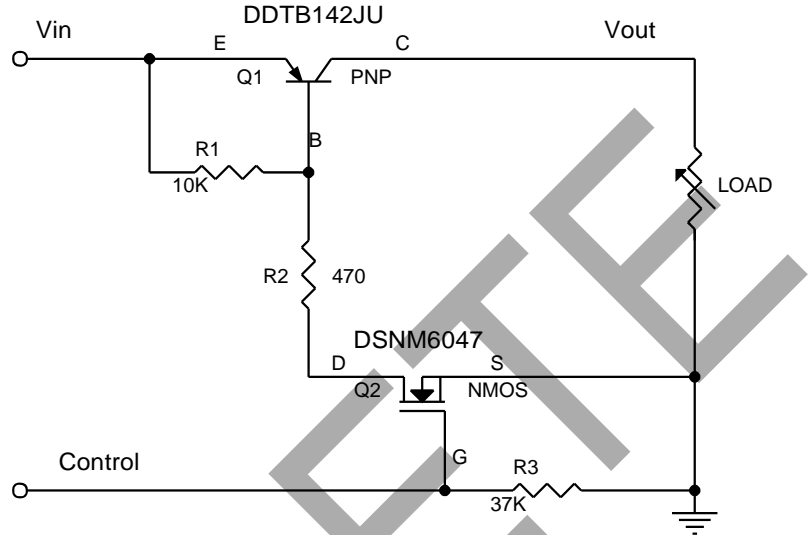

Fig. 19 Circuit Diagram

**Typical Application Circuit**

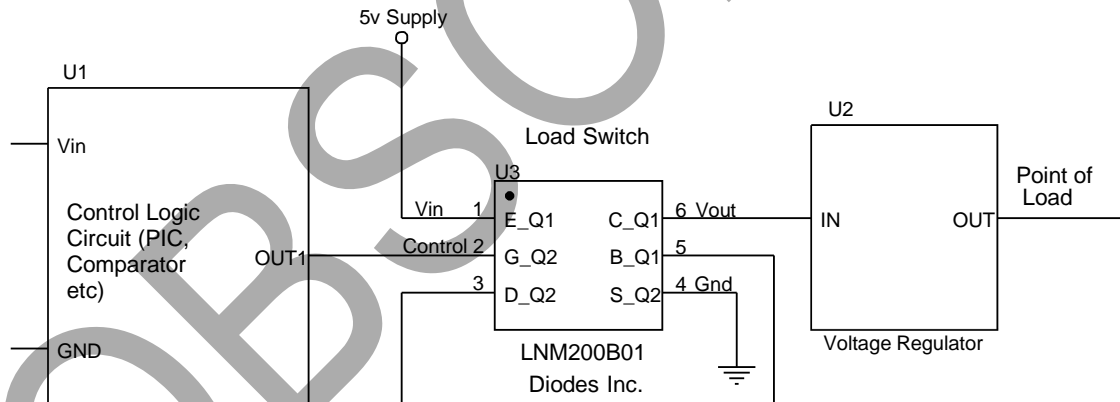

Fig. 20



**Ordering Information**

Device	Marking Code	Packaging	Shipping
LMN200B01-7	PM1	SOT-26	3000/Tape & Reel

Note: 5. For Packaging Details, go to our website at <http://www.diodes.com/datasheets/ap02007.pdf>.

**Marking Information**

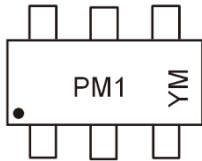

Fig. 21

PM1 = Product Type Marking Code,  
YM = Date Code Marking  
Y = Year ex: T = 2006  
M = Month ex: 9 = September

Date Code Key

Year	2006	2007	2008	2009
Code	T	U	V	W

Month	Jan	Feb	March	Apr	May	Jun	Jul	Aug	Sep	Oct	Nov	Dec
Code	1	2	3	4	5	6	7	8	9	O	N	D

OBSOLETE

**Mechanical Details**

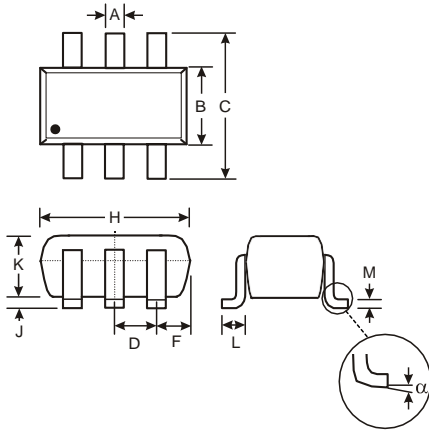

Fig. 22

SOT-26			
Dim	Min	Max	Typ
A	0.35	0.5	0.38
B	1.5	1.7	1.6
C	2.7	3	2.8
D	-	-	0.95
F	-	-	0.55
H	2.9	3.1	3
J	0.013	0.1	0.05
K	1	1.3	1.1
L	0.35	0.55	0.4
M	0.1	0.2	0.15
$\alpha$	0°	8°	-
All Dimensions in mm			

**Suggested Pad Layout: (Based on IPC-SM-782)**

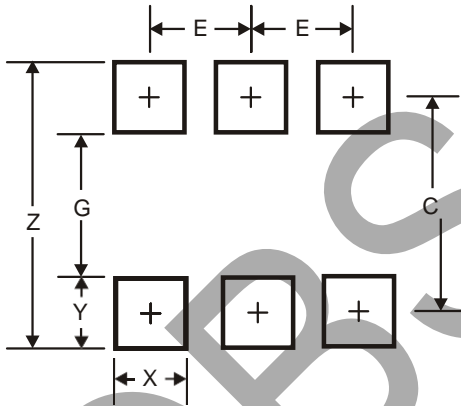

Fig. 23

Figure 23 Dimensions	SOT-26*
Z	3.2
G	1.6
X	0.55
Y	0.8
C	2.4
E	0.95

OBSOLETE - PART DISCONTINUED

**IMPORTANT NOTICE**

1. DIODES INCORPORATED AND ITS SUBSIDIARIES (“DIODES”) MAKE NO WARRANTY OF ANY KIND, EXPRESS OR IMPLIED, WITH REGARDS TO ANY INFORMATION CONTAINED IN THIS DOCUMENT, INCLUDING, BUT NOT LIMITED TO, THE IMPLIED WARRANTIES OF MERCHANTABILITY, FITNESS FOR A PARTICULAR PURPOSE OR NON-INFRINGEMENT OF THIRD PARTY INTELLECTUAL PROPERTY RIGHTS (AND THEIR EQUIVALENTS UNDER THE LAWS OF ANY JURISDICTION).
2. The Information contained herein is for informational purpose only and is provided only to illustrate the operation of Diodes products described herein and application examples. Diodes does not assume any liability arising out of the application or use of this document or any product described herein. This document is intended for skilled and technically trained engineering customers and users who design with Diodes products. Diodes products may be used to facilitate safety-related applications; however, in all instances customers and users are responsible for (a) selecting the appropriate Diodes products for their applications, (b) evaluating the suitability of the Diodes products for their intended applications, (c) ensuring their applications, which incorporate Diodes products, comply the applicable legal and regulatory requirements as well as safety and functional-safety related standards, and (d) ensuring they design with appropriate safeguards (including testing, validation, quality control techniques, redundancy, malfunction prevention, and appropriate treatment for aging degradation) to minimize the risks associated with their applications.
3. Diodes assumes no liability for any application-related information, support, assistance or feedback that may be provided by Diodes from time to time. Any customer or user of this document or products described herein will assume all risks and liabilities associated with such use, and will hold Diodes and all companies whose products are represented herein or on Diodes’ websites, harmless against all damages and liabilities.
4. Products described herein may be covered by one or more United States, international or foreign patents and pending patent applications. Product names and markings noted herein may also be covered by one or more United States, international or foreign trademarks and trademark applications. Diodes does not convey any license under any of its intellectual property rights or the rights of any third parties (including third parties whose products and services may be described in this document or on Diodes’ website) under this document.
5. Diodes products are provided subject to Diodes’ Standard Terms and Conditions of Sale (<https://www.diodes.com/about/company/terms-and-conditions/terms-and-conditions-of-sales/>) or other applicable terms. This document does not alter or expand the applicable warranties provided by Diodes. Diodes does not warrant or accept any liability whatsoever in respect of any products purchased through unauthorized sales channel.
6. Diodes products and technology may not be used for or incorporated into any products or systems whose manufacture, use or sale is prohibited under any applicable laws and regulations. Should customers or users use Diodes products in contravention of any applicable laws or regulations, or for any unintended or unauthorized application, customers and users will (a) be solely responsible for any damages, losses or penalties arising in connection therewith or as a result thereof, and (b) indemnify and hold Diodes and its representatives and agents harmless against any and all claims, damages, expenses, and attorney fees arising out of, directly or indirectly, any claim relating to any noncompliance with the applicable laws and regulations, as well as any unintended or unauthorized application.
7. While efforts have been made to ensure the information contained in this document is accurate, complete and current, it may contain technical inaccuracies, omissions and typographical errors. Diodes does not warrant that information contained in this document is error-free and Diodes is under no obligation to update or otherwise correct this information. Notwithstanding the foregoing, Diodes reserves the right to make modifications, enhancements, improvements, corrections or other changes without further notice to this document and any product described herein. This document is written in English but may be translated into multiple languages for reference. Only the English version of this document is the final and determinative format released by Diodes.
8. Any unauthorized copying, modification, distribution, transmission, display or other use of this document (or any portion hereof) is prohibited. Diodes assumes no responsibility for any losses incurred by the customers or users or any third parties arising from any such unauthorized use.

Copyright © 2021 Diodes Incorporated

[www.diodes.com](http://www.diodes.com)