

AN-1349 LM34910 Evaluation Board

1 Introduction

The LM34910EVAL evaluation board provides the design engineer with a fully functional buck regulator, employing the constant on-time (COT) operating principle. This evaluation board provides a 5V output from an input range of 8V - 36V. The circuit provides load currents >1A, with the current limit set at $\approx 1.3A$.

The board's specification are:

- Input Voltage: 8V to 36V
- Output Voltage: 5V, $\pm 3\%$
- Maximum Continuous Output current: 1.0A
- Current Limit: 1.3A
- Measured Efficiency: 92% ($V_{IN} = 8V$, $I_{OUT} = 400\text{ mA}$)
- Switching Frequency: $\approx 850\text{ kHz}$
- Size: 0.75 in. x 1.5 in. x 0.47 in

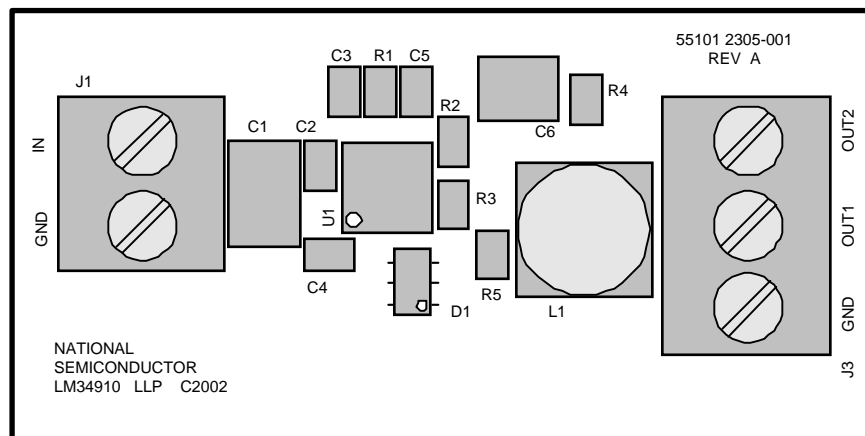

Figure 1. Evaluation Board - Top Side

2 Theory of Operation

Refer to the board's schematic in [Figure 2](#), which contains a simplified block diagram of the LM34910. When the circuit is in regulation, the buck switch is on each cycle for a time determined by R1 and V_{IN} . The on-time in this evaluation board will range from $\approx 775\text{ ns}$ at $V_{IN} = 8V$, to $\approx 200\text{ ns}$ at $V_{IN} = 36V$. At the end of the on-time, the feedback voltage at FB is above 2.5V, and the Minimum Off-Timer ensures the buck switch is off for at least 280 ns. In normal operation, the off-time is longer. During the off-time, the output capacitor (C6) discharges, and when the output voltage falls so that the voltage at FB is below 2.5V, the comparator output switches to initiate a new on-time. As required by the datasheet, this circuit provides a minimum of 25 mVp-p ripple at the FB pin. Refer to the LM34910 data sheet for a more detailed block diagram, and a complete description of the various functional blocks.

3 Board Layout and Probing

The pictorial in [Figure 1](#) shows the placement of the circuit components. The following should be kept in mind when the board is powered:

- 1) When operating at high input voltage and high load current, forced air flow **IS NECESSARY**.
- 2) The LM34910, and the diode D1 will be hot to the touch when operating at high input voltage and high load current.
- 3) Use CAUTION when probing the circuit due to the compact layout.
- 4) At maximum load current (1A), the wire size and length used to connect the load becomes important. Ensure there is not a significant drop in the wires.

4 Board Connection/Start-up

The input connections are made to the J1 connector. The load is normally connected to the OUT1 and GND terminals of the J3 connector. Ensure the wires are adequately sized for the intended load current. Before start-up a voltmeter should be connected to the input terminals, and to the output terminals. The load current should be monitored with an ammeter or a current probe. It is recommended that the input voltage be increased gradually to 8V, at which time the output voltage will be 5V. If that indicates correctly, then proceed with evaluating the circuit.

5 Low Ripple Output

The ripple voltage at OUT1 will range from ≈ 60 mVp-p (at $V_{IN} = 8V$) to ≈ 160 mVp-p (at $V_{IN} = 36V$). If a low ripple output is desired, connect the load to OUT2. The ripple at this output varies from ≈ 8 mVp-p to ≈ 26 mVp-p over the input voltage range. However, the load regulation is not as good at OUT2 as it is at OUT1 due to the presence of R4.

6 Increased Current Limit

The evaluation board current limit activates at a load current of $\approx 1.3A$. If it is desired to increase the current limit for a particular application, R5 must be added to the board. Refer to the data sheet to determine the appropriate value for this resistor

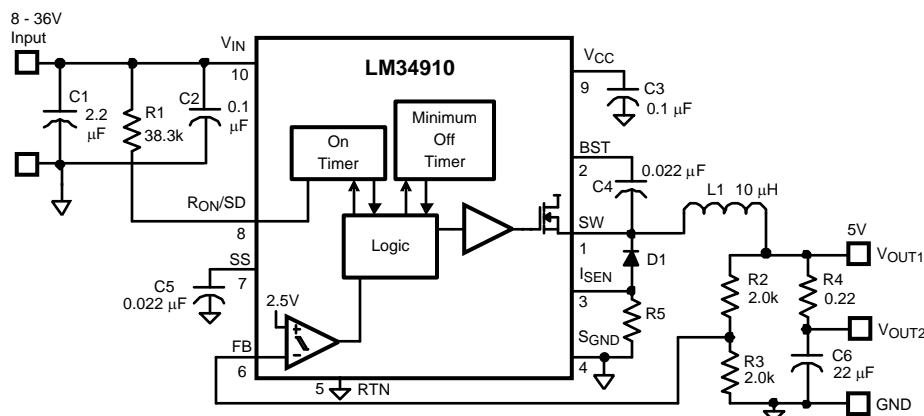

Figure 2. Board Schematic

Table 1. Bill of Materials

Item	Description	Mfg. Part No.	Package	Value
C1	Capacitor	TDK C3225X7R1H225K	1210	2.2 μ F, 50V
C2, 3	Capacitor	TDK C1608X7R1H104K	0603	0.1 μ F, 50V
C4, 5	Capacitor	TDK C1608X7R1H223K	0603	0.022 μ F, 16V
C6	Capacitor	TDK C3216Y5V1A226Z	1206	22 μ F, 10V

Table 1. Bill of Materials (continued)

Item	Description	Mfg. Part No.	Package	Value
D1	Schottky diode	Zetex ZLLS2000	SOT-23-6	40V, 2.2A
L1	Inductor	TKD SLF6028T-100M1R3	6 mm x 6 mm	10 μ H, 1.3A
R1	Resistor	TDK CRCW06033832F100	0603	38.3 k Ω
R2, 3	Resistor	TDK CRCW06032001F100	0603	2.0 k Ω
R4	Resistor	Panasonic ERJ6RQFR22V	0805	0.22 Ω , 1/8W
R5	Resistor	See data sheet	0805	
U1	Switching Regulator	LM34910	WSOON-10	

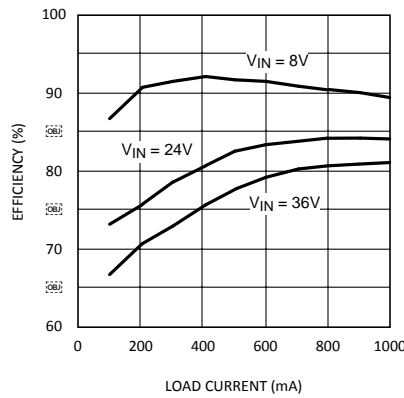

Figure 3. Efficiency vs Load Current

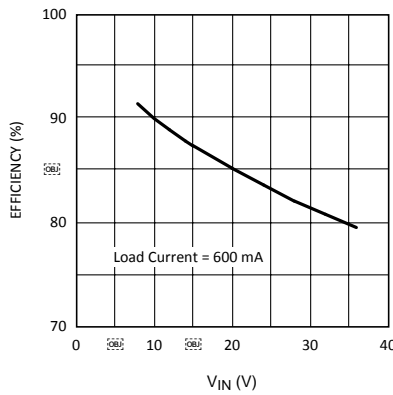

Figure 4. Efficiency vs VIN

7 PCB Layout

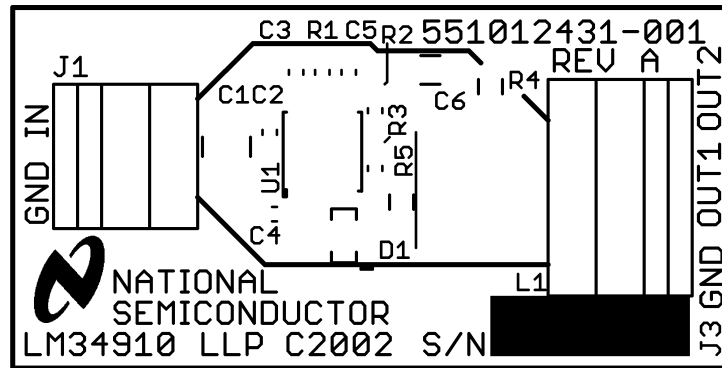

Figure 5. Board Silkscreen

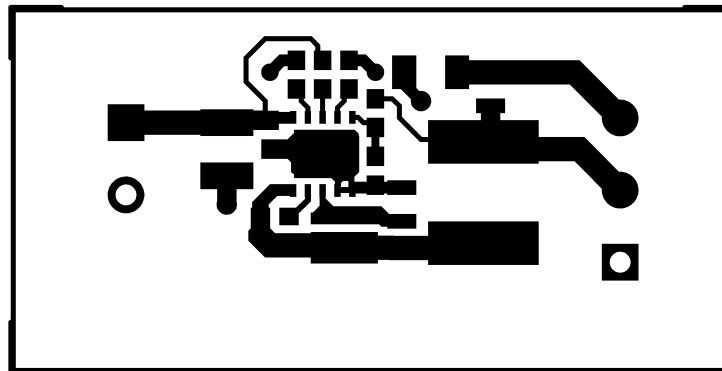

Figure 6. Board Top Layer

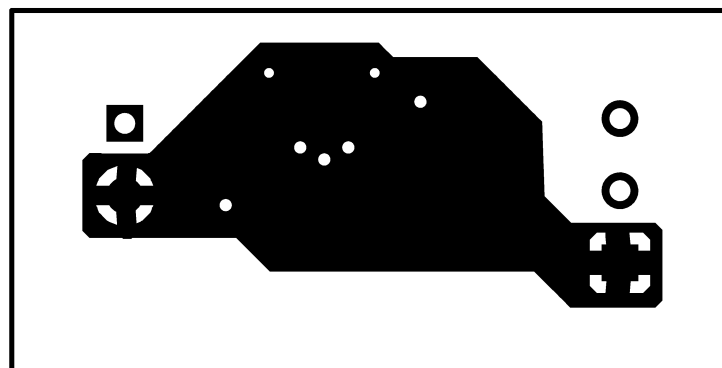

Figure 7. Board Bottom Layer

IMPORTANT NOTICE

Texas Instruments Incorporated and its subsidiaries (TI) reserve the right to make corrections, enhancements, improvements and other changes to its semiconductor products and services per JESD46, latest issue, and to discontinue any product or service per JESD48, latest issue. Buyers should obtain the latest relevant information before placing orders and should verify that such information is current and complete. All semiconductor products (also referred to herein as "components") are sold subject to TI's terms and conditions of sale supplied at the time of order acknowledgment.

TI warrants performance of its components to the specifications applicable at the time of sale, in accordance with the warranty in TI's terms and conditions of sale of semiconductor products. Testing and other quality control techniques are used to the extent TI deems necessary to support this warranty. Except where mandated by applicable law, testing of all parameters of each component is not necessarily performed.

TI assumes no liability for applications assistance or the design of Buyers' products. Buyers are responsible for their products and applications using TI components. To minimize the risks associated with Buyers' products and applications, Buyers should provide adequate design and operating safeguards.

TI does not warrant or represent that any license, either express or implied, is granted under any patent right, copyright, mask work right, or other intellectual property right relating to any combination, machine, or process in which TI components or services are used. Information published by TI regarding third-party products or services does not constitute a license to use such products or services or a warranty or endorsement thereof. Use of such information may require a license from a third party under the patents or other intellectual property of the third party, or a license from TI under the patents or other intellectual property of TI.

Reproduction of significant portions of TI information in TI data books or data sheets is permissible only if reproduction is without alteration and is accompanied by all associated warranties, conditions, limitations, and notices. TI is not responsible or liable for such altered documentation. Information of third parties may be subject to additional restrictions.

Resale of TI components or services with statements different from or beyond the parameters stated by TI for that component or service voids all express and any implied warranties for the associated TI component or service and is an unfair and deceptive business practice. TI is not responsible or liable for any such statements.

Buyer acknowledges and agrees that it is solely responsible for compliance with all legal, regulatory and safety-related requirements concerning its products, and any use of TI components in its applications, notwithstanding any applications-related information or support that may be provided by TI. Buyer represents and agrees that it has all the necessary expertise to create and implement safeguards which anticipate dangerous consequences of failures, monitor failures and their consequences, lessen the likelihood of failures that might cause harm and take appropriate remedial actions. Buyer will fully indemnify TI and its representatives against any damages arising out of the use of any TI components in safety-critical applications.

In some cases, TI components may be promoted specifically to facilitate safety-related applications. With such components, TI's goal is to help enable customers to design and create their own end-product solutions that meet applicable functional safety standards and requirements. Nonetheless, such components are subject to these terms.

No TI components are authorized for use in FDA Class III (or similar life-critical medical equipment) unless authorized officers of the parties have executed a special agreement specifically governing such use.

Only those TI components which TI has specifically designated as military grade or "enhanced plastic" are designed and intended for use in military/aerospace applications or environments. Buyer acknowledges and agrees that any military or aerospace use of TI components which have **not** been so designated is solely at the Buyer's risk, and that Buyer is solely responsible for compliance with all legal and regulatory requirements in connection with such use.

TI has specifically designated certain components as meeting ISO/TS16949 requirements, mainly for automotive use. In any case of use of non-designated products, TI will not be responsible for any failure to meet ISO/TS16949.

Products

Audio	www.ti.com/audio
Amplifiers	amplifier.ti.com
Data Converters	dataconverter.ti.com
DLP® Products	www.dlp.com
DSP	dsp.ti.com
Clocks and Timers	www.ti.com/clocks
Interface	interface.ti.com
Logic	logic.ti.com
Power Mgmt	power.ti.com
Microcontrollers	microcontroller.ti.com
RFID	www.ti-rfid.com
OMAP Applications Processors	www.ti.com/omap
Wireless Connectivity	www.ti.com/wirelessconnectivity

Applications

Automotive and Transportation	www.ti.com/automotive
Communications and Telecom	www.ti.com/communications
Computers and Peripherals	www.ti.com/computers
Consumer Electronics	www.ti.com/consumer-apps
Energy and Lighting	www.ti.com/energy
Industrial	www.ti.com/industrial
Medical	www.ti.com/medical
Security	www.ti.com/security
Space, Avionics and Defense	www.ti.com/space-avionics-defense
Video and Imaging	www.ti.com/video

TI E2E Community

e2e.ti.com