

Customer Part:

Description

- Standard 3.2 x 2.5mm SMD crystal in a ceramic package with a seam sealed metal lid, hermetically sealed.
- Model CFPX-180
- Model Issue number 11

Frequency Parameters

- Frequency 20.0MHz
- Frequency Tolerance ±10.00ppm
- Tolerance Condition @ 25°C
- Frequency Stability ±30.00ppm
- Operating Temperature Range -40.00 to 105.00°C
- Overtone Order Fundamental
- Ageing ±5ppm max per year @ 25°C

Electrical Parameters

- Load Capacitance (CL) 9.00pF
- Shunt Capacitance (C0) 7pF max
- Drive Level 100µW max
- ESR 50.00Ω max

Environmental Parameters

- Storage Temperature Range: -55 to 125°C
- Shock: MIL-STD-202F, Method 213B: 1000g, 0.5ms, 1/2 sine wave
- Vibration: MIL-STD-202F, Method 204D, Test Condition D: 20g (10Hz-2000Hz), 4hrs in 3 mutually perpendicular planes (total 12hrs)

Manufacturing Details

- RoHS Terminations NiAu
- RoHS Reflow Temp 260degC 10s

Compliance

- RoHS Status (2015/863/EU) Compliant
- REACH Status Compliant
- MSL Rating (JDEC-STD-033): Not Applicable

Packaging Details

- Pack Style: RL3K Tape & reel in accordance with EIA-481-D
Pack Size: 3,000
- *Alternative packing option available*



Outline (mm)

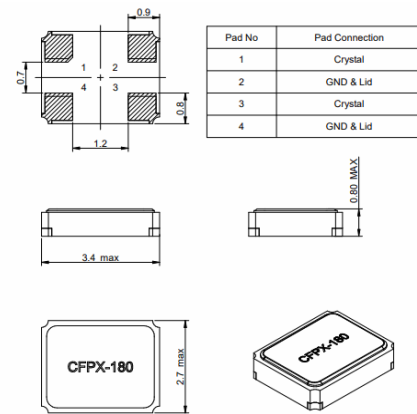

Recommended Solder Pad Layout

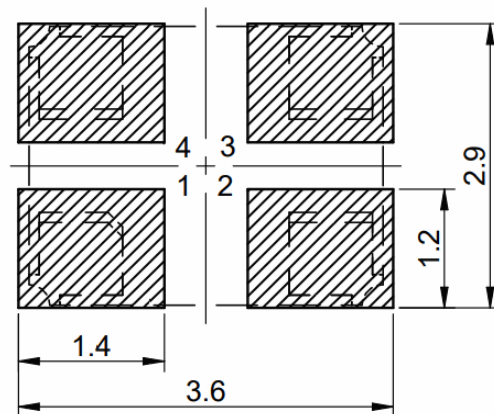

Sales Office Contact Details:

UK: +44 (0)1460 270200

USA: +1.760 668 8935

Email: info@iqdfrequencyproducts.com

Web: www.iqdfrequencyproducts.com