

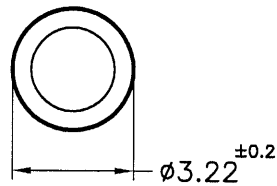

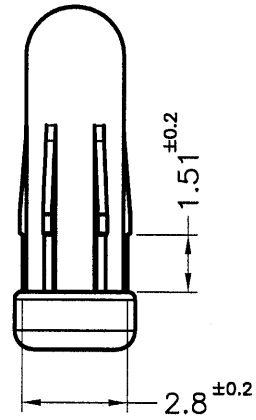

REVISIONS			
REV	DESCRIPTION	DATE	BY

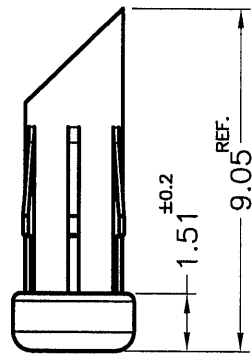
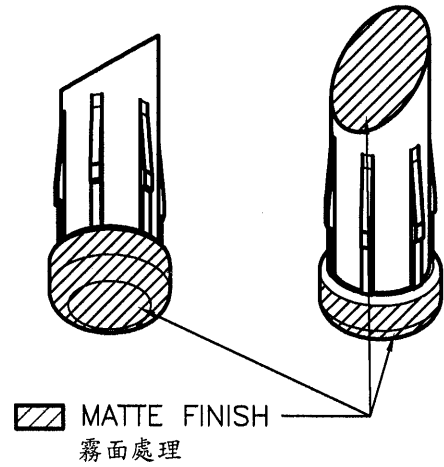

NOTE: MADE OF EQUIVALENT MATERIAL.  
 均可使用同等材質.

 康揚企業股份有限公司 KANG YANG HARDWARE ENTERPRISE CO., LTD. 康揚塑膠(東莞)有限公司 KANG YANG PLASTIC(DONG GUAN) CO., LTD. ISO 9001 ISO 14001 QC 080000 康哲電腦配件(吳江)有限公司 KANG CHE COMPUTER COMPONENTS(WUJIANG) CO., LTD.				TITLE	LIGHT PIPE		SPEC. DWG.		
				MATERIAL	PC		DATE	2015.12.16	
				FINISH			DRAWN	M.F	
				COLOR	TRANSPARENT		CHECK		
PART NUMBER	LEM-208		DRAWING NUMBER	LEM-208		UNLESS OTHERWISE SPECIFIED TOLERANCE	SEE ABOVE		
SIZE	SCALE	UNIT	REV	APPROVED					
A4	5:1	mm	B						