

W48×H48mm, Weekly/Yearly Timer

■ Features

- Easy to check and change the program setting
- Customizable weekly or yearly unit time setting and control by user
- Includes daylight saving time function
- 1 independent control output. (relay)
- Flush and surface, DIN rail mounting are in one unit.



⚠ Please read "Safety Considerations" in the instruction manual before using.



■ Ordering Information

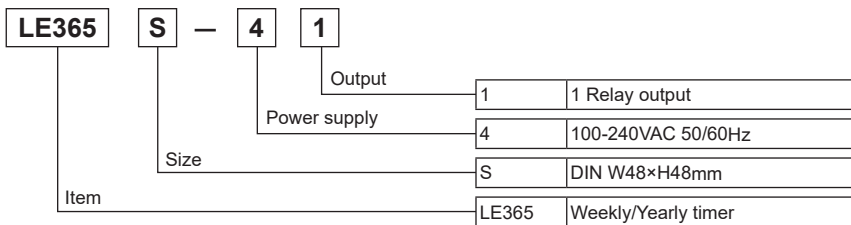

■ Specifications

Model	LE365S-41	
Power supply	100-240VAC~ 50/60Hz	
Allowable voltage range	90 to 110% of rated voltage	
Power consumption	Max. 2.4VA (100-240VAC~)	
Timing program	48 steps for weekly, 24 steps for yearly	
Operation mode	ON/OFF mode, cycle mode, pulse mode	
Mounting	Panel flush, surface, DIN rail	
Time deviation	±15 sec/month (ambient temperature: 25°C) (±4 sec/week)	
Temperature error	±0.01% ±0.05 sec	
Memory protection	Over 5 years (at 25°C)	
Control Output	Contact type	SPST (Single Pole Single Throw)
	Contact capacity	250VAC~ 15A, 30VDC= 5A resistive load
	Output number	Independent 1 output (1a)
Relay life cycle	Mechanical	Min. 5,000,000 operations (switching capacity 30 times/min)
	Electrical	50,000 operations<switching capacity 20 times/min, 250VAC 15A (resistive load)>
Insulation resistance	Over 100MΩ (at 500VDC megger)	
Dielectric strength	2,000VAC 50/60Hz for 1min	
Noise immunity	±2kV the square wave noise (pulse width: 1μs) by the noise simulator	
Environment	Ambient temperature	-10 to 55°C, storage: -25 to 65°C
	Ambient humidity	35 to 85%RH
Approval	CE c UL US	
Unit weight	Approx. 110g	

※Environment resistance is rated at no freezing or condensation.

■ Connections

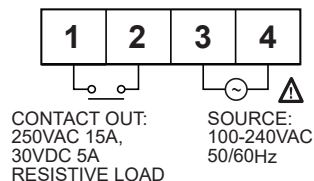

SENSORS
CONTROLLERS
MOTION DEVICES
SOFTWARE

(J) Temperature Controllers
(K) SSRs
(L) Power Controllers
(M) Counters
(N) Timers
(O) Digital Panel Meters
(P) Indicators
(Q) Converters
(R) Digital Display Units
(S) Sensor Controllers
(T) Switching Mode Power Supplies
(U) Recorders
(V) HMIs
(W) Panel PC
(X) Field Network Devices

LE365S-41

Dimensions

(unit: mm)

1) Front panel mounting

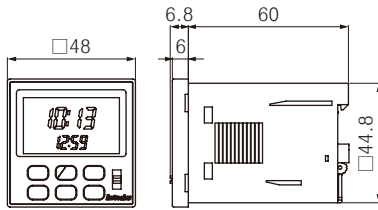

Bracket

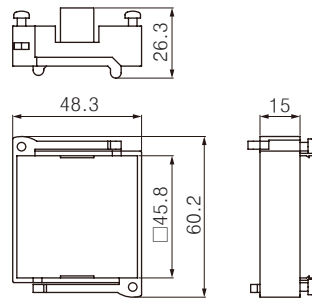

Panel cut-out

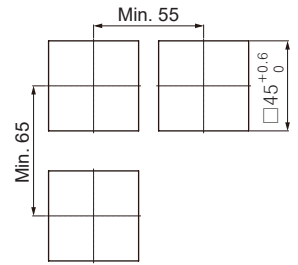

2) Surface mounting

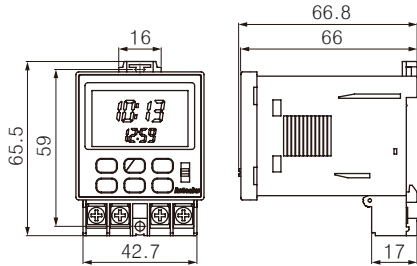

Panel hole cut-out

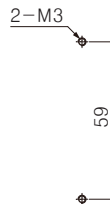

3) DIN rail mounting

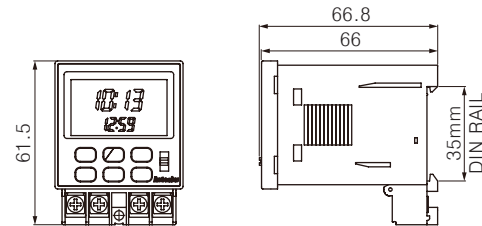

How to Switch from The Flush Mounting to Surface or DIN Rail Mounting Type

Remove terminals from the body after unscrewing terminals screws, and then assemble terminals to the body after rotating terminals as shown below.

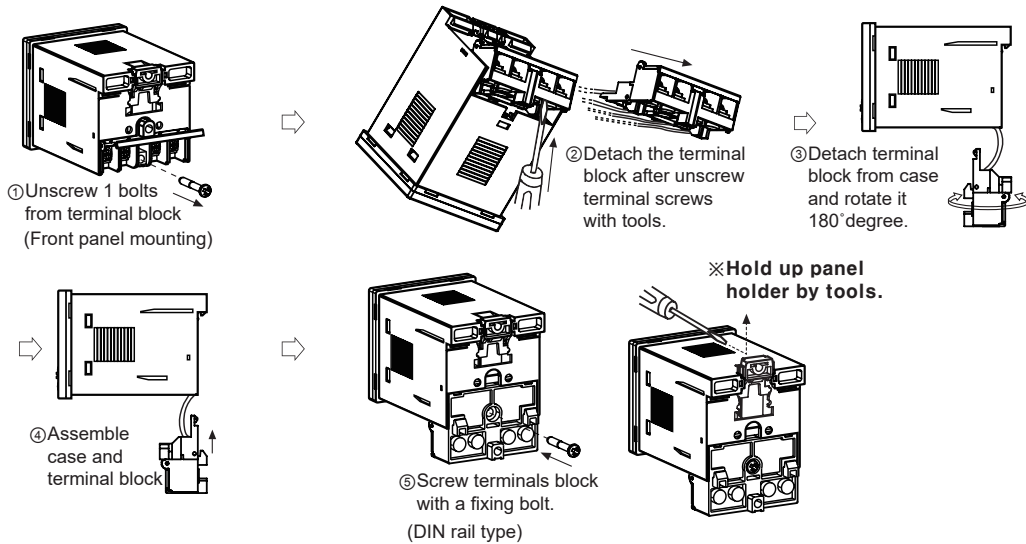

Unit Description

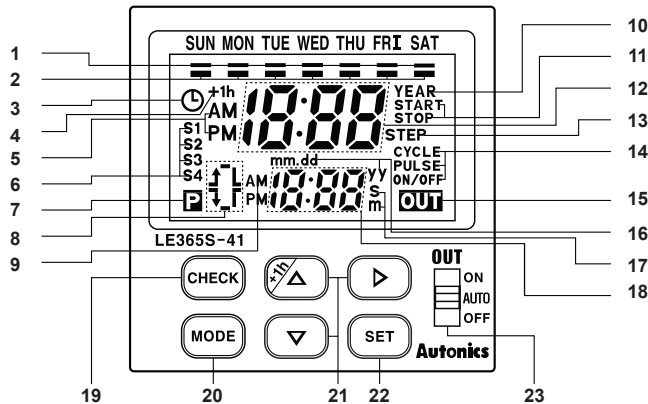

1. Day indicator
2. Day display
 - Light: Day is selected.
 - Light-out: Day is not selected.
3. Current time setting mode indicator
4. DST display (daylight saving time)
5. AM/PM display (main display)
6. Season display
7. Program display
8. Display ON time/day, OFF time/day, ON time width, OFF time width
9. AM/PM display (sub-display)
10. YEAR display
 - It turns ON when set, check, modify, delete yearly program, set yearly holidays and operate yearly program.
11. Yearly START/STOP day display
12. Main display

13. Remaining step display
14. Operation mode display
15. Output mode display
16. Year, month, date display
17. Unit of pulse width display
18. Sub display
19. CHECK key
20. MODE key
21. Operation key
 - Press **+1h** key over 3 sec in RUN mode, DST mode is set and released.
22. SET key
23. Output selection switch
 - AUTO: Control output according to the set program.
 - ON: Output is ON. (operation)
 - OFF: Output is OFF. (block)

Functions

Definitions

- Record: A part of program that controls output operation.
- Step: Basic component of Record.

Operation modes

- If the operation mode of Program 1 (program 2) is set on pulse mode initially, the pulse mode is fixed for additional programs. If the operation mode of Program 1 (program 2) is set on ON/OFF or cycle mode initially, pulse mode cannot be used for additional pulse programs.
- If the weekly operation mode is set on ON/OFF or cycle mode, the yearly operation mode is fixed on ON/OFF mode.
If the yearly operation mode is set on ON/OFF, the weekly operation mode is fixed on ON/OFF or cycle mode.
- If the weekly operation mode is set on pulse mode, the yearly operation mode is fixed on pulse mode. If the yearly operation mode is set on pulse mode, the weekly operation mode is fixed on pulse.

- Weekly ON/OFF mode
Output operation by ON/OFF set time.
 - Min. time setting unit: 1 min
 - It is able to set ON/OFF day separately.
 - One record in two steps (ON day/ON time, OFF day/OFF time)



- Weekly Cycle operation
It outputs ON the set ON time width which is from Cycle operation ON time to Cycle operation OFF time, and it outputs OFF the set OFF time width.

SENSORS
CONTROLLERS
MOTION DEVICES
SOFTWARE

(J) Temperature Controllers
(K) SSRs
(L) Power Controllers
(M) Counters
(N) Timers
(O) Digital Panel Meters
(P) Indicators
(Q) Converters
(R) Digital Display Units
(S) Sensor Controllers
(T) Switching Mode Power Supplies
(U) Recorders
(V) HMIs
(W) Panel PC
(X) Field Network Devices

- Set range for ON/OFF time width
: 1 min to 12 hour 59 min
- One record in 3 steps (ON day/ON time, OFF day/OFF time, ON time width/OFF time width)

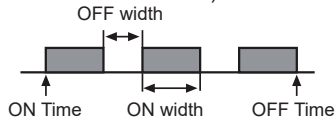

- Weekly pulse mode
Output turns ON at ON time for a specified pulse width.
(Pulse width: 1 to 59 sec, 1 to 60 min)
- One record in two steps (ON day/ON time, pulse width)

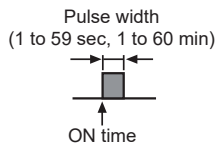

- Yearly ON/OFF mode
Output turns ON at ON time on START date and turns OFF at OFF time on STOP date.
- One record in three Steps (START/STOP date, ON/OFF time)
- Yearly pulse mode
Output turns ON at ON time on START date and turns OFF at OFF time on STOP time for a specified pulse width repeatedly.
- One record in three steps (START/STOP date, ON time, Pulse width)

⊙ Program operation

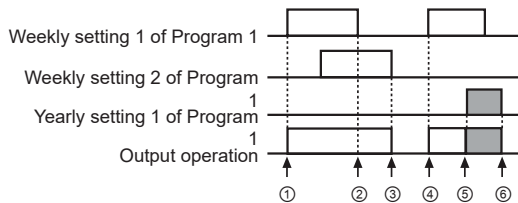

- ① to ②: Operated by weekly setting 1 of Program 1.
- ② to ③: Operated by weekly setting 2 of Program 1.
- ④ to ⑤: Operated by weekly setting 1 of Program 1.
- ⑤ to ⑥: Operated by yearly setting 1 of Program 1.
(during weekly program operation at 12:00 AM on START date, the weekly program operation stops, and it changes to yearly program operation mode. The yearly program operation stops at 12:00 AM on the next day of STOP date.)

⊙ Display and change of next mode

- The day of next mode in Program is displayed on the day indicator, and the time of next mode is displayed on the lower row of screen.
- In ON/OFF operation mode, set ON time and OFF time to next mode. In Pulse operation mode, set Pulse ON time to next mode.

⊙ Power restore mode

In setting group 2 - LEVEL2 (rEt turns ON, rEt or nOr flashes), select Auto[rEt] or Normal[nOr] by ▲ or ▼ key and press [SET] key to set.

- Auto[rEt] power restore mode
Output operates according to program when power turns ON again after power failure.
- Normal[nOr] power restore mode
When power turns ON again after power failure, output is kept OFF and rEn flashes on the lower row of screen and power restore input (press [SET] key over 3 sec in RUN mode) is applied, rEn turns OFF and output operates according to program.

⊙ Season switching mode

This feature uses for setting seasonal weekly operation mode. To operate this mode, save starting month and date, ending month and date of each season which displays S1, S2, S3, S4 then set day and time of each season in weekly program setting. It is also able to operate only in summer and winter season. (S1: set summer season, S2: set winter season, S3/S4: do not set)

In setting group 2-Level 2 (SEn turns ON, OFF flashes.), select ON[On] by ▲ or ▼ key and press [SET] key to save.

When the season switching mode changed from OFF to On or vice versa, previous set programs are deleted.

- ON[On] mode
Weekly program is switched automatically by season switching.

- Period setting per season

- ① Press [SET] key in period setting per season mode of setting group 2. (SEn flashes, season with preset period turns ON and **START** and **STOP** turn ON.)
 - ② Advance to the flashing position of season selection among S1, S2, S3, S4 by ▲ or ▼ key and press [SET] key.
 - ③ After set **START** month, date per season and press [SET] key.
 - ④ [SET] key is pressed after set **STOP** month, date per season, it is advanced to LEVEL1 of period setting per season. Add or adjust the period setting by [SET] key.
- It is disable to use when it is OFF [OFF].
 - If season terms are overlapped, these are prioritized in S4>S3>S2>S1 order.

☉ Daylight saving time

To utilize daylight during the summer season, daylight saving time is adjusted forward one hour from standard time.

In setting group 2-LEVEL 2 (d5t turns ON, Rt or nor flashes), select Auto [Rt] or Normal [nor] by ▲ or ▼ key and press [SET] key to set.

- Auto [Rt] daylight saving time mode

Current time will be faster as an hour when it is started and slower as an hour when it is finished.

- Automatic daylight saving time period setting

① Automatic daylight saving time period setting LEVEL 1 of setting group 2.

(press [SET] key when d5t flashes and **START** and **STOP** turn ON.)

② Set START date (month, date) of automatic daylight saving time mode and press [SET] key.

③ Set START time (AM/PM, hour) of automatic daylight saving time mode and press [SET] key. But, the minute will be fixed as 00.

④ Set STOP date (month, date) of automatic daylight saving time mode and press [SET] key.

⑤ Set STOP time (AM/PM, hour) of automatic daylight saving time mode and press [SET] key. But, the minute will be fixed as 00.

- Normal [nor] daylight saving time mode

Press [+1h] key over 3sec in RUN mode, "+1h" turns ON and current time is faster as an hour and "+1h" turns ON out or vice versa, when press [+1h] key over 3sec again.

☉ Current time setting

(E.g.) Set the current time as 10, Mar, 2008, 5:10 PM.

① Advance to the current time setting mode

SUN MON TUE WED THU FRI SAT



[MODE] + [SET] keys are pressed over 3 sec in RUN mode, it is advanced to current time setting of setting group 2 and clock will be flashed and t.RU will be lighted in second display part, press [SET] key.

② Year, Month, Date setting

SUN MON TUE WED THU FRI SAT



Press ▲ or ▼ key to set 08 (year 2008) and move the flashing digit to position month by ► key.

Press [SET] key after pressing ▲ or ▼ key to set date 10.

③ Current time (AM, PM) setting

SUN MON TUE WED THU FRI SAT



Press ▲ or ▼ key to select PM and move the flashing digit to position hour by ► key.

④ Current time (hour, min) setting

SUN MON TUE WED THU FRI SAT



Press ▲ or ▼ key to set 5 PM and move the flashing digit to position min by ► key. Press ▲ or ▼ key to set 10 min and press [SET] key and it is returned to RUN mode when pressing [MODE] key over 3 sec

- It advances to "①Current time setting mode" in ON status and set current time as shown above ② to ④ by [SET] key.
- Current time is set up to 31, Dec., 2099.
- Check current year/month/date in RUN mode When ► key is pressed over 3sec in RUN mode, it advances to current year/month/date display. After display current year/month/date for 3sec, it returns to RUN mode displaying current display.

SENSORS
CONTROLLERS
MOTION DEVICES
SOFTWARE
(J) Temperature Controllers
(K) SSRs
(L) Power Controllers
(M) Counters
(N) Timers
(O) Digital Panel Meters
(P) Indicators
(Q) Converters
(R) Digital Display Units
(S) Sensor Controllers
(T) Switching Mode Power Supplies
(U) Recorders
(V) HMIs
(W) Panel PC
(X) Field Network Devices

Program Setting

Setting group 1

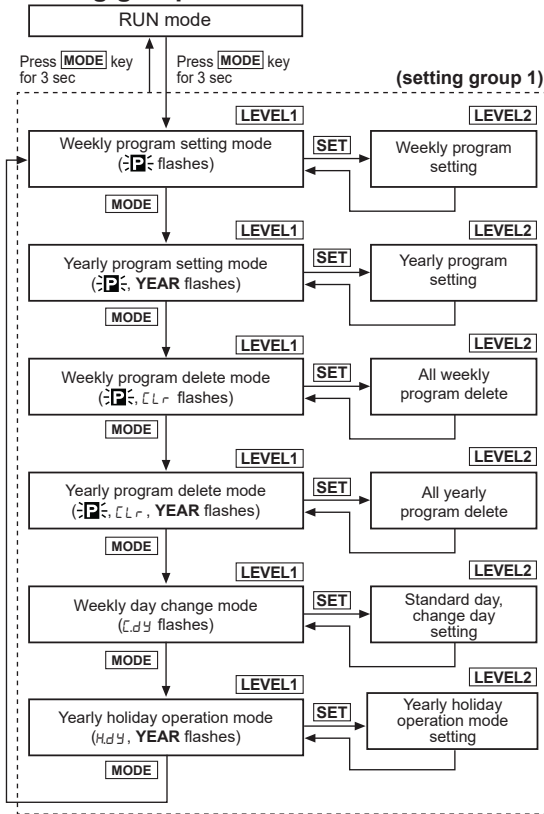

- When it is advanced to setting group 1 in RUN mode, output will be OFF.
- It is returned to previous setting group 1 when power of time switch is ON again in setting group 1.
- When **MODE** key is pressed in LEVEL2 of setting group 1, current setting will be canceled and it is returned to previous LEVEL1.
- When press **SET** key to program over max. number of steps for weekly program in Weekly program setting mode of setting group 1-LEVEL 1, number of remaining steps and **STEP** flash and it returns to LEVEL 1 status.
- When press **SET** key to program over max. number of steps for yearly program in Yearly program setting mode of setting group 1-LEVEL 1, number of remaining steps and **STEP** flash it returns to LEVEL 1 status.

Setting group 2

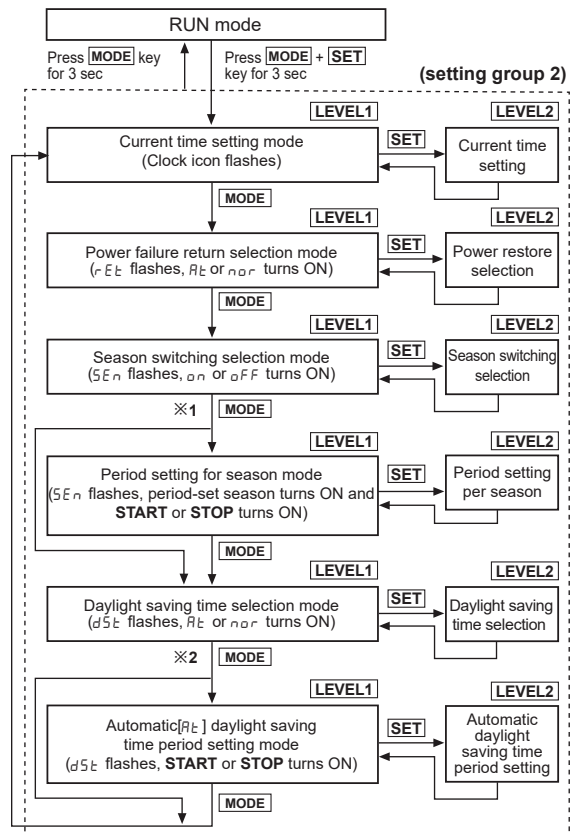

- ※1: Season switching selection is **OFF**.
- ※2: Automatic switching selection of Daylight Saving Time is Normal[**nor**].
- When it advances to setting group 2 in RUN mode, output (OUT1, OUT2) will be OFF.
- When power of time switch is ON again in setting group 2, it is returned to previous setting group 1.
- Front **MODE** key is pressed in LEVEL2 of setting group 2, it is returned to previous LEVEL1.
- When season switching selection is changed from **OFF** to **on** or **on** to **OFF**, previous set weekly program will be deleted.

Weekly/Yearly Timer

Example of Weekly program setting

Weekly ON/OFF mode

(E.g.) Output 1 (OUT1) is ON from Monday to Friday at 8:00 AM and OFF at 6:10 PM.

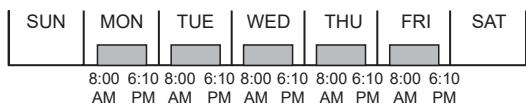

1 Advance to weekly program setting mode

SUN MON TUE WED THU FRI SAT

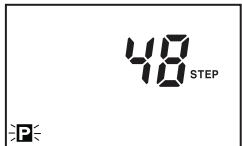

[MODE] key is pressed over 3sec in RUN mode P flashes and press [SET] key.

2 Mode type setting

SUN MON TUE WED THU FRI SAT



Press [SET] key in ON/OFF mode.

3 ON day setting

SUN MON TUE WED THU FRI SAT

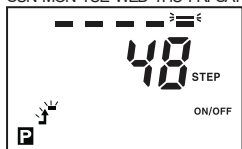

Press [] key to move the indicator to Monday, it will be lighted when [] or [] key are pressed and move it to Tuesday by [] key. Press [SET] key after Tuesday, Wednesday, Thursday, Friday turn ON.

4 ON time setting (AM, PM)

SUN MON TUE WED THU FRI SAT



[] key is pressed, move the flashing to hour position and select PM by [] or [] key when ON time is afternoon.

5 ON time setting (hour, min)

SUN MON TUE WED THU FRI SAT



Set 8:00 by [] or [] key and press [SET] key.

6 OFF day setting

SUN MON TUE WED THU FRI SAT

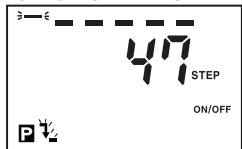

Press [SET] key to check ON/OFF day.

7 OFF time setting (AM, PM)

SUN MON TUE WED THU FRI SAT



Select PM by [] or [] key and move the flashing to hour position by [] key.

8 OFF time setting (hour, min)

SUN MON TUE WED THU FRI SAT



Move the flashing to minute position by [] key after set 6:00 by [] or [] key and set the minute as 10 by [] or [] key and press [SET] key.

9 Complete to set

SUN MON TUE WED THU FRI SAT



Press [SET] key to set additional program.

Weekly Pulse mode

(E.g.) Output 2 (OUT2) is ON for 10 sec at 8:00 AM from Monday to Friday during S2 season in case, period of S1, S2, S3, S4 is set.

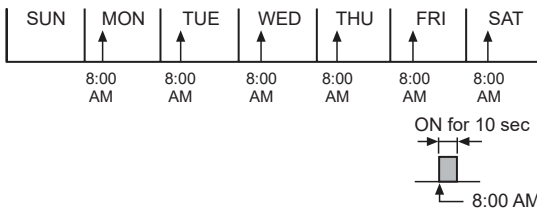

1 Advance to weekly program setting mode

SUN MON TUE WED THU FRI SAT

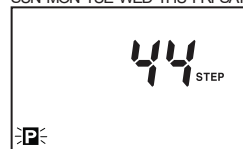

[MODE] key is pressed for 3 sec in RUN mode, P flashes and press [SET] key.

2 Mode type setting

SUN MON TUE WED THU FRI SAT



Press [] or [] key when ON/OFF flashes, pulse flashes and press [SET] key.

3 Season selection

SUN MON TUE WED THU FRI SAT



Press [] or [] key to select season S2 and press [SET] key.

SENSORS
CONTROLLERS
MOTION DEVICES
SOFTWARE

(J) Temperature Controllers
(K) SSRs
(L) Power Controllers
(M) Counters
(N) Timers
(O) Digital Panel Meters
(P) Indicators
(Q) Converters
(R) Digital Display Units
(S) Sensor Controllers
(T) Switching Mode Power Supplies
(U) Recorders
(V) HMIs
(W) Panel PC
(X) Field Network Devices

④ ON day setting

SUN MON TUE WED THU FRI SAT

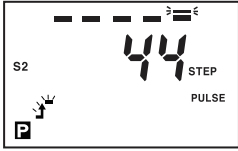

Press **▶** key to move the indicator to Monday, it will be lighted when **▲** or **▼** key is pressed and move it to Tuesday by **▶** key. Press **SET** key after light Tuesday, Wednesday, Thursday and Friday.

⑤ ON time setting (AM, PM)

SUN MON TUE WED THU FRI SAT



Press **▶** key, move the flashing to hour position and select PM by **▲** or **▼** key when ON time is afternoon.

⑥ ON time setting (hour, min)

SUN MON TUE WED THU FRI SAT

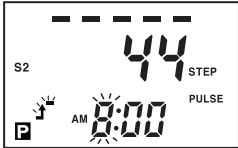

Set 8:00 by **▲** or **▼** key and press **SET** key.

⑦ Pulse width setting

SUN MON TUE WED THU FRI SAT



Press **▲** or **▼** key to select pulse width as 10s and press **SET** key.

⑧ Complete to set

SUN MON TUE WED THU FRI SAT

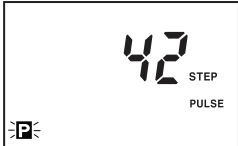

Press **SET** key to set additional program.

• Weekly Cycle mode

(E.g.) Output 1 (OUT1) is ON for 10 min and OFF for 5 min from Monday 6:00 AM to Saturday 5:30 PM.

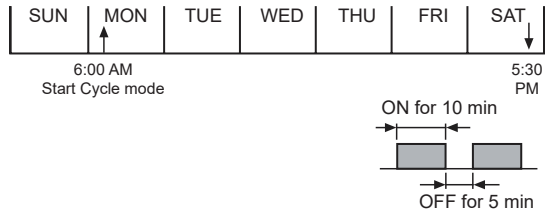

① Advance to weekly program setting mode

SUN MON TUE WED THU FRI SAT



In RUN mode, press **MODE** key for 3 sec and **P** flashes. Press **SET** key.

② Mode type setting

SUN MON TUE WED THU FRI SAT



Press **▲** or **▼** key when ON/OFF flashes, cycle flashes and press **SET** key.

③ to ⑧

Refer to ③ to ⑧ of "Weekly ON/OFF mode" to set ON day, ON time, OFF day and OFF time.

⑨ ON time width setting

SUN MON TUE WED THU FRI SAT



Press **▶** key to move the flashing to minute position and set as 10 min by **▲** or **▼** key and press **SET** key.

⑩ OFF time width setting

SUN MON TUE WED THU FRI SAT



Press **▶** key to move the flashing to minute position and set as 5 min by **▲** or **▼** key and press **SET** key.

⑪ Complete to set

SUN MON TUE WED THU FRI SAT



Press **SET** key to set additional program.

○ Weekly day change

When the specified day mode is required to install in other day, it is started from the set day and returned to previous program setting automatically when it is finished.

● Weekly day change cancellation

- ① Change current year, month, date in current time setting mode
- ② Change standard day
- ③ Delete all program in program
- ④ Season switching

● Setting example

Output is ON in Saturday at 9:00 AM and OFF at 12:00 PM and it is ON 8:30 AM and OFF at 6:00 PM from Monday to Friday and the mode of Monday and Tuesday is operated temporarily as Saturday (standard) program.

① Advance to weekly day change mode

SUN MON TUE WED THU FRI SAT



Press **[MODE]** key over 3 sec to move to the setting group1 in RUN mode and press it repeatedly until **C.dY** flashes in second display part and press **[SET]** key.

② Standard day selection

SUN MON TUE WED THU FRI SAT



Press **[▶]** key to move the indicator to Saturday and press **[SET]** key. after select Saturday as standard day (SAT turns ON) by **[▲]** or **[▼]** key.

③ Change day selection

SUN MON TUE WED THU FRI SAT



Press **[▶]** key to move the indicator to Monday and select Monday to change (Monday turns ON) by **[▲]** or **[▼]** key and repeat the procedure to select Tuesday to change (TUE turns ON) and press **[SET]** key to complete.

○ Yearly holiday mode

It operates to off the output without program adjustment during previously set yearly holiday period available from present year to 31, Dec. of the next year.

Designate the start date of yearly holiday and year of end date as every year [- -] to repeat the holiday mode for specified in every year.

● Setting example

Set every year 5, May to off the output.

① Advance to yearly holiday mode

SUN MON TUE WED THU FRI SAT



Press **[MODE]** key over 3 sec to move to the setting group1 in RUN mode and press it repeatedly until **H.dY** flashes in second display part and press **[SET]** key.

② Yearly holiday number display

SUN MON TUE WED THU FRI SAT



Press **[SET]** key after check yearly holiday number.

③ Start date of yearly holiday setting

SUN MON TUE WED THU FRI SAT

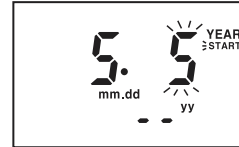

Press **[▶]** key until month[- -] position flashes and set May by **[▲]** or **[▼]** key and press **[▶]** key until date position flashes. Press **[SET]** key after set 5th by **[▲]** or **[▼]** key.

④ End date of yearly holiday setting

SUN MON TUE WED THU FRI SAT



The flashing is moved to month[- -] position directly and press **[▲]** or **[▼]** key to set May and press **[▶]** key until date position flashes. Press **[SET]** key after set 5th by **[▲]** or **[▼]** key.

⑤ Complete to yearly holiday

SUN MON TUE WED THU FRI SAT



Press **[MODE]** key to finish the additional yearly holiday setting and press **[SET]** key to set .

※ It is able to set yearly holiday up to 12 times.

SENSORS

CONTROLLERS

MOTION DEVICES

SOFTWARE

(J) Temperature Controllers

(K) SSRs

(L) Power Controllers

(M) Counters

(N) Timers

(O) Digital Panel Meters

(P) Indicators

(Q) Converters

(R) Digital Display Units

(S) Sensor Controllers

(T) Switching Mode Power Supplies

(U) Recorders

(V) HMIs

(W) Panel PC

(X) Field Network Devices

◎ Yearly program setting

● Yearly ON/OFF mode

(E.g.) Output (OUT) is ON from every 5, Apr to 7, Apr at 9:00 AM and OFF 5:10 PM.

① Advance to Program 1 (P1) yearly program setting mode

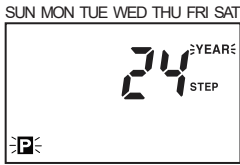

Press **[MODE]** key for 3 sec in RUN mode, **[P]** flashes and press **[MODE]** key once, then, **[P]** and YEAR flash and press **[SET]** key to set.

② Mode type setting

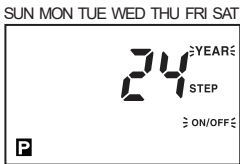

Press **[SET]** key when ON/OFF flashes.

③ Start date setting

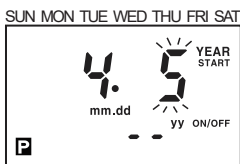

Press **[▶]** key until month position flashes and set Apr by **[▲]** or **[▼]** key and press **[▶]** key until date position flashes. Press **[SET]** key after set 5th by **[▲]** or **[▼]** key.

④ End date setting

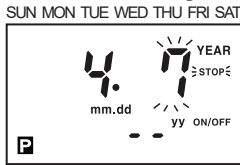

The flashing is moved to month position directly and press **[▲]** or **[▼]** key to set April and press **[▶]** key until date position flashes. Press **[SET]** key after set 7th by **[▲]** or **[▼]** key.

⑤ ON time setting (AM, PM)



[▶] key is pressed, move the flashing to hour position and select PM by **[▲]** or **[▼]** key when ON time is afternoon.

⑥ ON time setting (hour, min)



Press **[▲]** or **[▼]** key to set 9 and press **[SET]** key after check 00 min

⑦ OFF time setting (AM, PM)



Select PM by **[▲]** or **[▼]** key and move the flashing to hour position by **[▶]** key.

⑧ OFF time setting (hour, min)

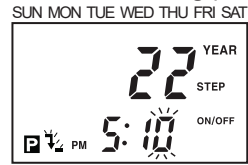

Move the flashing to minute position after set 5:00 by **[▲]** or **[▼]** key and set the minute as 10 and press **[SET]** key.

⑨ Complete to set

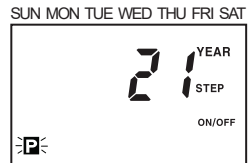

Press **[SET]** key to set additional program.

● Yearly pulse mode

(E.g.) Output (OUT) is ON from 2, Oct., 2008 to 4, Oct, 2008 at 10:00 AM and OFF after 5 sec (present is 2007.)

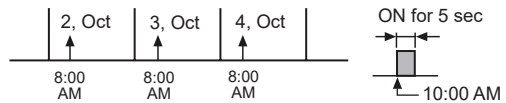

① Advance to yearly program setting mode

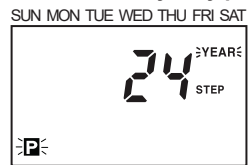

[MODE] key is pressed for 3 sec in RUN mode, **[P]** flashes and press **[MODE]** key again, **[P]** flashes and press **[SET]** key.

② Mode type setting

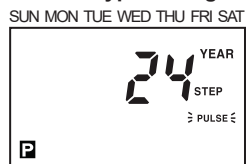

[▲] or **[▼]** key is pressed when ON/OFF flashes to set pulse mode and press **[SET]** key.

③ Start date setting

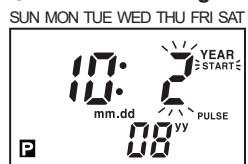

Press **[▲]** or **[▼]** key twice to set 08 (year 2008) and move to month position by **[▶]** key. Set Oct. by **[▲]** or **[▼]** key and move to date position by **[▶]** key and press **[SET]** key after set 2nd by **[▲]** or **[▼]** key.

④ End date setting

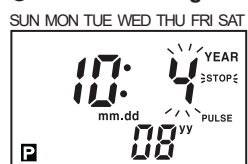

The flashing is moved to month position directly by **[▶]** key and set 4th by **[▲]** or **[▼]** key after move it to date position by **[▶]** key, then press **[SET]** key.

Weekly/Yearly Timer

⑤ ON time setting (AM, PM)

SUN MON TUE WED THU FRI SAT

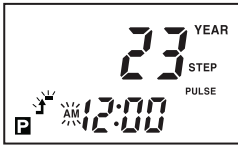

▶ key is pressed, move the flashing to hour position and select PM by ▲ or ▼ key when ON time is afternoon.

⑥ ON time setting (hour, min)

SUN MON TUE WED THU FRI SAT



Press ▲ or ▼ key twice to set 10 and press [SET] key after check 00 min

⑦ Pulse width setting

SUN MON TUE WED THU FRI SAT



Press ▲ or ▼ key 4 times to select pulse width as 5s and press [SET] key.

⑧ Complete to set

SUN MON TUE WED THU FRI SAT



Press [SET] key to set additional program.

※ It is able to set year of start/end date in yearly program setting up to 2 years later from the present year.

■ Program Check, Modify and Delete

○ Weekly program check, modify and delete

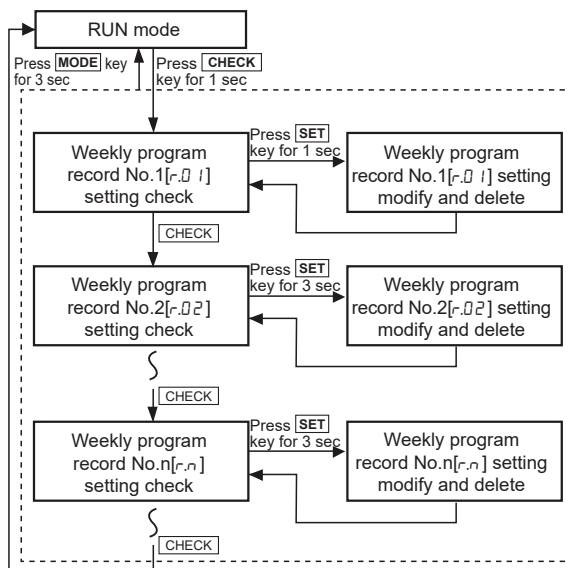

○ Yearly program check, modify and delete

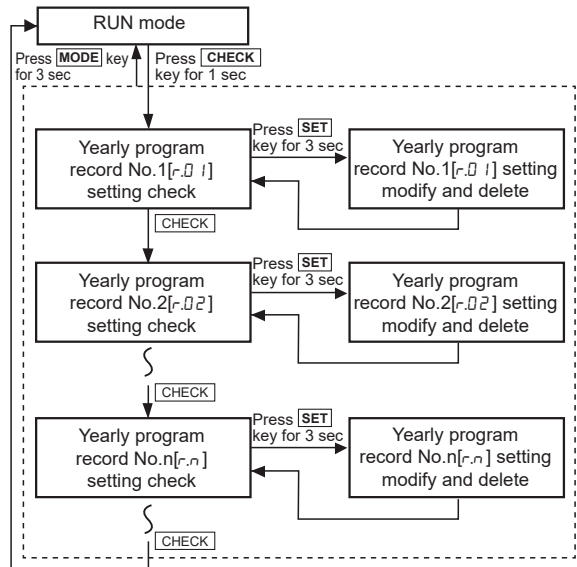

※ **YEAR** turns ON when check, modify or delete yearly program.

- If any key is untouched for 60 sec, it is returned to RUN mode in weekly or yearly program check.
- In weekly or yearly program check, it controls output according to program setting and output is OFF in modify or delete mode.
- When [MODE] key is pressed in weekly or yearly program record modify, delete stand by or delete mode, current work is canceled and it is returned to check mode.
- Weekly or yearly program record modify and delete
 - (1) Program record modify
 - ① When press [SET] key over 3 sec in program check, *Edt* flashes in second display part, press [SET] key.
 - ② It returns to check mode when finish the modify same as the above procedure.
 - (2) Program record delete
 - ① When press [SET] key over 3 sec in program check, *Edt* flashes in second display part, press ▲ or ▼ key until *LLr* flashes in second display part and press [SET] key.
 - ② Press *LLr* key over 3 sec when [SET] turns ON in second display part, it returns to program check.

SENSORS

CONTROLLERS

MOTION DEVICES

SOFTWARE

(J) Temperature Controllers

(K) SSRs

(L) Power Controllers

(M) Counters

(N) Timers

(O) Digital Panel Meters

(P) Indicators

(Q) Converters

(R) Digital Display Units

(S) Sensor Controllers

(T) Switching Mode Power Supplies

(U) Recorders

(V) HMIs

(W) Panel PC

(X) Field Network Devices