

# OSRAM LE RTDUW S2WN

## Datasheet

Published by **ams-OSRAM AG**

Tobelbader Strasse 30, 8141 Premstaetten, Austria

Phone +43 3136 500-0

[ams-osram.com](http://ams-osram.com)

© All rights reserved



## OSRAM OSTAR® Stage

# LE RTDUW S2WN

Compact lightsource in SMT technology, glass window on top,  
RoHS compliant

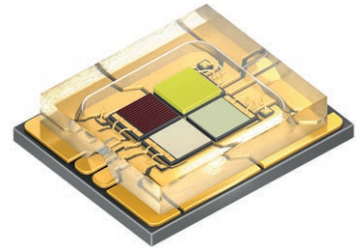

## Applications

- Entertainment

## Features

- Package: compact lightsource in multi chip SMT technology with glass window on top
- Chip technology: Thinfilm / UX:3
- Typ. Radiation: 120° (Lambertian emitter)
- Color:  $\lambda_{\text{dom}} = 625 \text{ nm}$  (● red);  $\lambda_{\text{dom}} = 525 \text{ nm}$  (● true green);  $\lambda_{\text{dom}} = 453 \text{ nm}$  (● deep blue);  $C_x = 0.31$ ,  $C_y = 0.32$  acc. to CIE 1931 (● ultra white)
- Corrosion Robustness Class: 3B
- ESD: 2 kV acc. to ANSI/ESDA/JEDEC JS-001 (HBM, Class 2)

## Ordering Information

Type	Brightness 1)	Ordering Code
LERTDUWS2WN-KBLA-1+MANA-F+AXAZ-P+MBNB-CQ		Q65113A5080
● red	● $\Phi V = 90 \dots 140 \text{ lm (IF = 1000 mA)}$	
● true green	● $\Phi V = 180 \dots 355 \text{ lm (IF = 1000 mA)}$	
● deep blue	● $\Phi E = 1120 \dots 1800 \text{ mW (IF = 1000 mA)}$	
● ultra white	● $\Phi V = 224 \dots 450 \text{ lm (IF = 1000 mA)}$	
LERTDUWS2WN-KBLA-1+MBNA-F+AYAZ-P+NANB-CQ		Q65113A5081
● red	● $\Phi V = 90 \dots 140 \text{ lm (IF = 1000 mA)}$	
● true green	● $\Phi V = 224 \dots 355 \text{ lm (IF = 1000 mA)}$	
● deep blue	● $\Phi E = 1300 \dots 1800 \text{ mW (IF = 1000 mA)}$	
● ultra white	● $\Phi V = 280 \dots 450 \text{ lm (IF = 1000 mA)}$	
LERTDUWS2WN-KBLA-1+MBNA-C+AXAY-T+MBNA-P		Q65113A5135
● red	● $\Phi V = 90 \dots 140 \text{ lm (IF = 1000 mA)}$	
● true green	● $\Phi V = 224 \dots 355 \text{ lm (IF = 1000 mA)}$	
● deep blue	● $\Phi E = 1120 \dots 1500 \text{ mW (IF = 1000 mA)}$	
● ultra white	● $\Phi V = 224 \dots 355 \text{ lm (IF = 1000 mA)}$	

Q65113A5080 and Q65113A5081 contain

true green	3+4+7 and
deep blue	3+4 dominant wavelength and
ultra white	CQ color coordinate bins

Q65113A5135 contains

true green	5+6
deep blue	3+5 dominant wavelength and
ultra white	61+67 color coordinate bins

## Maximum Ratings

Parameter	Symbol		Values	Values	Values	Values
			● red	● true green	● deep blue	● ultra white
Operating Temperature	$T_{op}$	min.	-40 °C	-40 °C	-40 °C	-40 °C
		max.	85 °C	85 °C	85 °C	85 °C
Storage Temperature	$T_{stg}$	min.	-40 °C	-40 °C	-40 °C	-40 °C
		max.	85 °C	85 °C	85 °C	85 °C
Junction Temperature	$T_j$	max.	125 °C	150 °C	150 °C	150 °C
Forward Current $T_s = 25\text{ °C}$	$I_F$	min.	40 mA	40 mA	40 mA	40 mA
		max.	2500 mA	3000 mA	3000 mA	3000 mA
ESD withstand voltage acc. to ANSI/ESDA/ JEDEC JS-001 (HBM, Class 2)	$V_{ESD}$		2 kV	2 kV	2 kV	2 kV
Reverse current <sup>1)</sup>	$I_R$	max.	200 mA	200 mA	200 mA	200 mA

## Characteristics

$I_F = 1000 \text{ mA}$ ;  $T_S = 25 \text{ °C}$

Parameter	Symbol		Values			
			● red	● true green	● deep blue	● ultra white
Chromaticity Coordinate <sup>2)</sup>	Cx	typ.				0.31
	Cy	typ.				0.32
Peak Wavelength	$\lambda_{\text{peak}}$	typ.	633 nm	521 nm	445 nm	443 nm
Dominant Wavelength <sup>3)</sup>	$\lambda_{\text{dom}}$	min.	620 nm	519 nm	449 nm	
		typ.	625 nm	525 nm	453 nm	
		max.	632 nm	531 nm	458 nm	
Spectral bandwidth at 50% $I_{\text{rel,max}}$	$\Delta\lambda$	typ.	16 nm	31 nm	18 nm	
Viewing angle at 50% $I_V$	$2\phi$	typ.	120 °	120 °	120 °	130 °
Radiating surface For value(s) see red column, all chips operated simultaneously	$A_{\text{color}}$	typ.	2.1 x 2.1 mm <sup>2</sup>			
Partial Flux acc. CIE 127:2007 <sup>4)</sup> $\Phi_{E/V 120^\circ} = x * \Phi_{E/V 180^\circ}$	$\Phi_{E/V, 120^\circ}$	typ.	0.82	0.82	0.82	0.77
Forward Voltage <sup>5)</sup> $I_F = 1000 \text{ mA}$	$V_F$	min.	1.85 V	2.30 V	2.70 V	2.70 V
		typ.	2.35 V	2.90 V	3.00 V	3.00 V
		max.	2.80 V	3.30 V	3.40 V	3.40 V
Reverse voltage (ESD device)	$V_{R \text{ ESD}}$	min.	45 V	45 V	45 V	45 V
Reverse voltage <sup>1)</sup> $I_R = 20 \text{ mA}$	$V_R$	max.	1.2 V	1.2 V	1.2 V	1.2 V
Real thermal resistance junction/solderpoint <sup>6)</sup> For value(s) see red column, all chips operated simultaneously	$R_{\text{thJS real}}$	typ.	1.20 K / W			
		max.	1.40 K / W			
Electrical thermal resistance junction/solderpoint <sup>6)</sup> With efficiency $\eta_e = 26\%$ ; for value(s) see red column, all chips operated simultaneously	$R_{\text{thJS elec.}}$	typ.	0.89 K / W			
		max.	1.04 K / W			

## Brightness Groups

Color of emission	Group	Luminous Flux <sup>7)</sup> $I_F = 1000 \text{ mA}$ min. $\Phi_V$	Luminous Flux <sup>7)</sup> $I_F = 1000 \text{ mA}$ max. $\Phi_V$
● red	KB	90 lm	112 lm
● red	LA	112 lm	140 lm
● true green	MA	180 lm	224 lm
● true green	MB	224 lm	280 lm
● true green	NA	280 lm	355 lm
● deep blue	AX	1120 mW	1300 mW
● deep blue	AY	1300 mW	1500 mW
● deep blue	AZ	1500 mW	1800 mW
● ultra white	MB	224 lm	280 lm
● ultra white	NA	280 lm	355 lm
● ultra white	NB	355 lm	450 lm

### Wavelength Groups

- true green

Group	Dominant wavelength <sup>3)</sup>	
	min. $\lambda_{dom}$	max. $\lambda_{dom}$
3	519 nm	525 nm
4	525 nm	531 nm
5	519 nm	526 nm
6	524 nm	531 nm
7	531nm	537 nm

### Wavelength Groups

- deep blue

Group	Dominant wavelength <sup>3)</sup>	
	min. $\lambda_{dom}$	max. $\lambda_{dom}$
3	449 nm	453 nm
4	453 nm	458 nm
5	452 nm	458 nm

### Chromaticity Coordinate Groups <sup>2)</sup>

- ultra white

Group	Cx	Cy
CQ	0.3190	0.3507
	0.3267	0.3370
	0.3107	0.3043
	0.3020	0.3178

Group	CCT	Center		4step		$\Theta$
		Cx	Cy	a	b	
61	6100K	0.3196	0.3343	0.0120	0.0075	54.7
67	6700K	0.3114	0.3190	0.0121	0.0071	56.0

## Chromaticity Coordinate Groups

Colour Coordinates for  
Q651135080 LERTDUWS2WN-KBLA-1+MANA-F+AXAZ-P+MBNB-CQ and  
Q65113A5081 LERTDUWS2WN-KBLA-1+MBNA-F+AYAZ-P+NANB-CQ

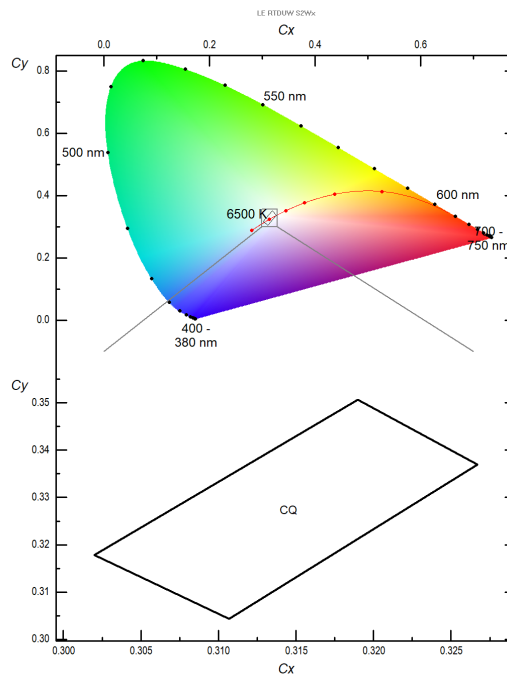

## Chromaticity Coordinate Groups

Colour Coordinates for  
Q65113A5135 LERTDUWS2WN-KBLA-1+MBNA-C+AXAY-T+MBNA-P

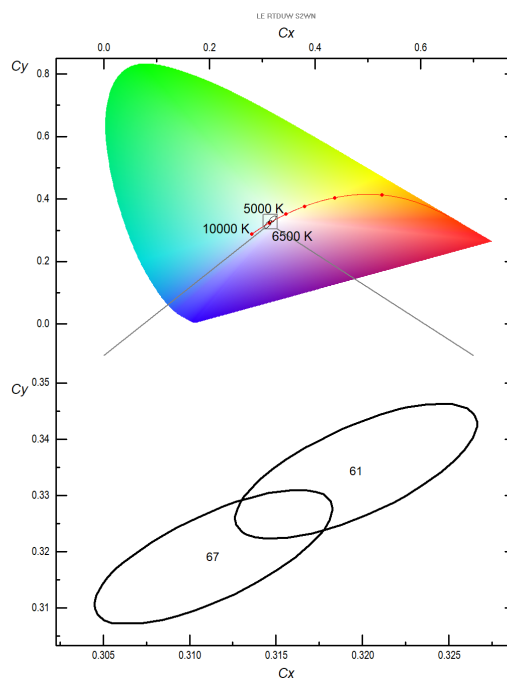



### Relative Spectral Emission <sup>4)</sup>

$\Phi_{rel} = f(\lambda)$ ;  $I_F = 1000 \text{ mA}$ ;  $T_J = 25 \text{ }^\circ\text{C}$

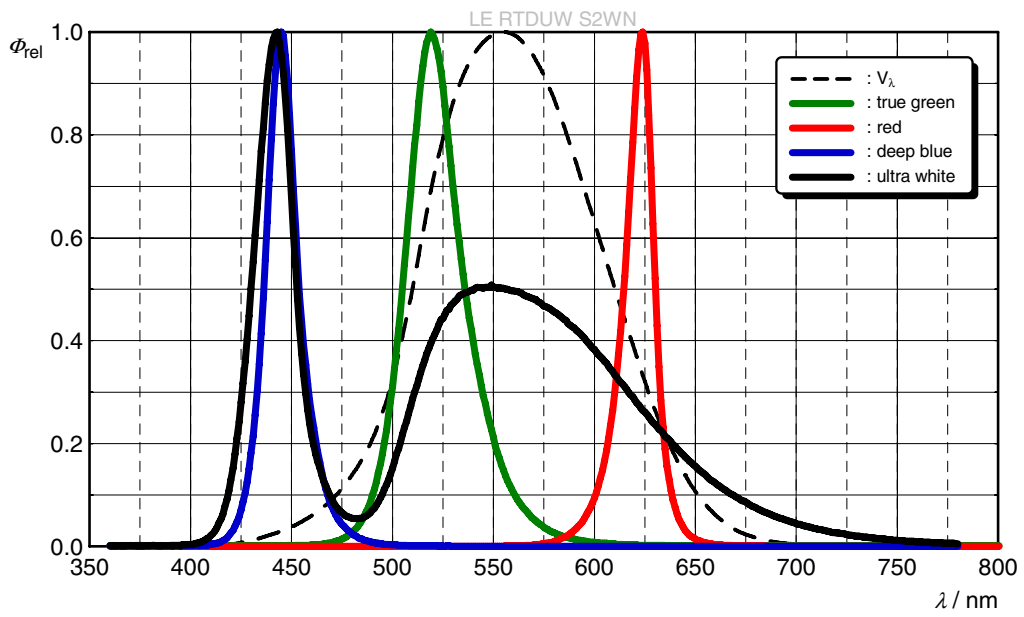

### Radiation Characteristics <sup>4)</sup>

$I_{rel} = f(\phi)$ ;  $T_J = 25\text{ °C}$ ; red; true green; blue

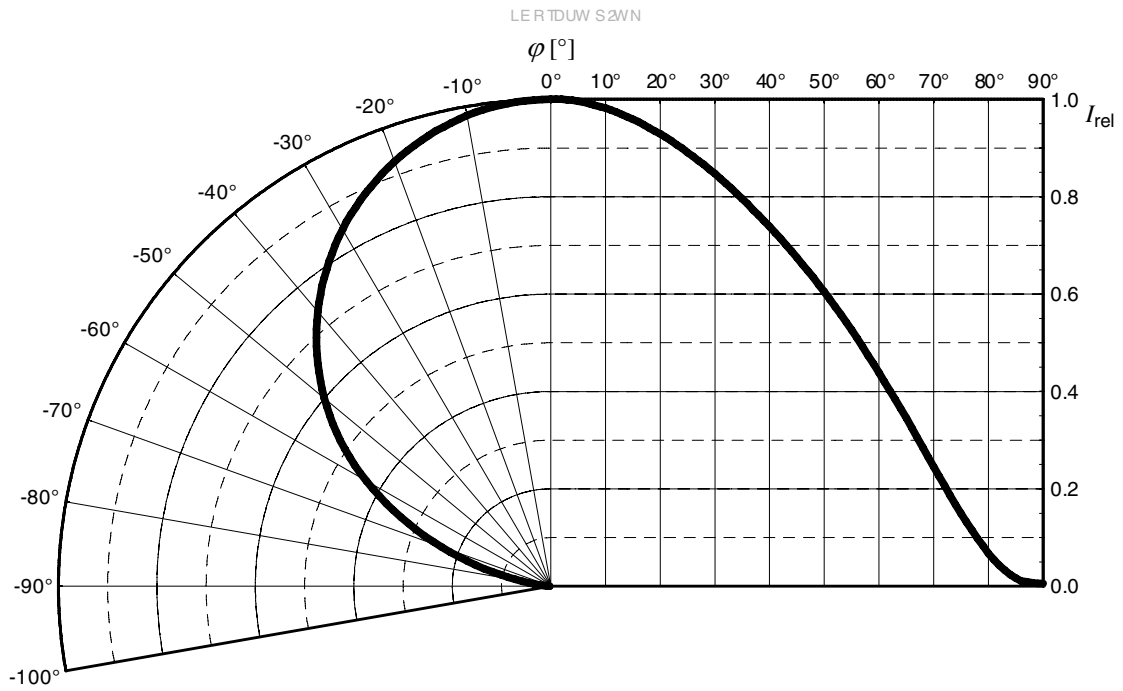

### Radiation Characteristics <sup>4)</sup>

$I_{rel} = f(\phi)$ ;  $T_J = 25\text{ °C}$ ; ultra white

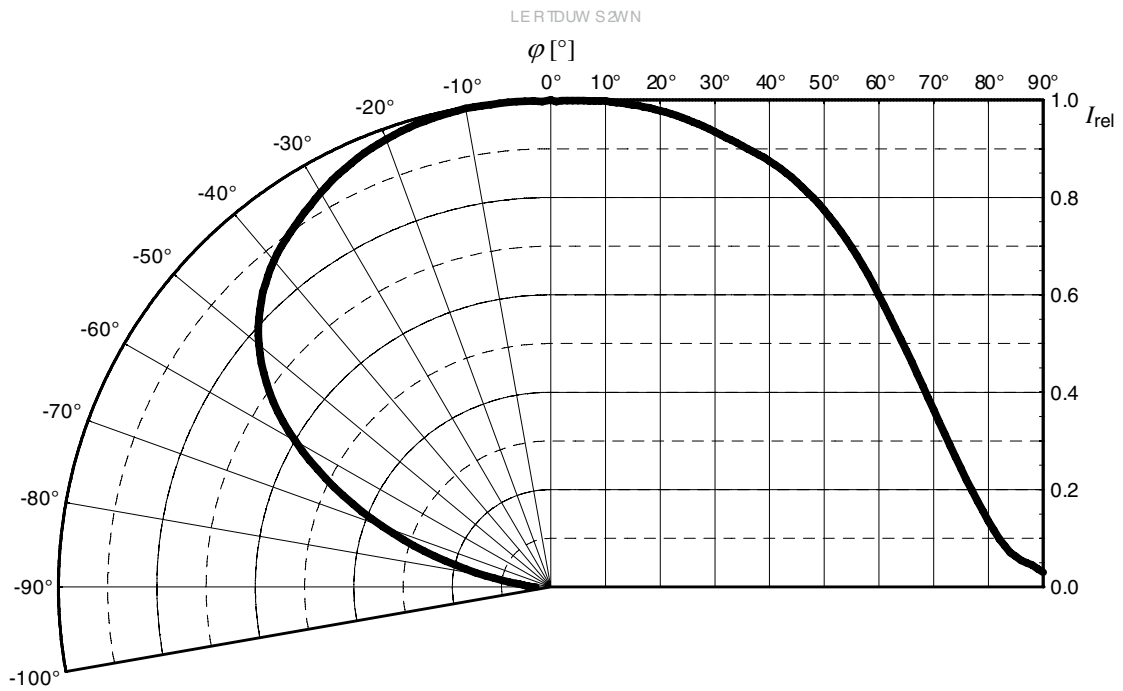

### Relative Partial Flux <sup>4)</sup>

$\Phi_{EM}(2\varphi)/\Phi_{EM}(180^\circ) = f(\varphi)$ ;  $T_J = 25^\circ\text{C}$ ; red; true green; blue

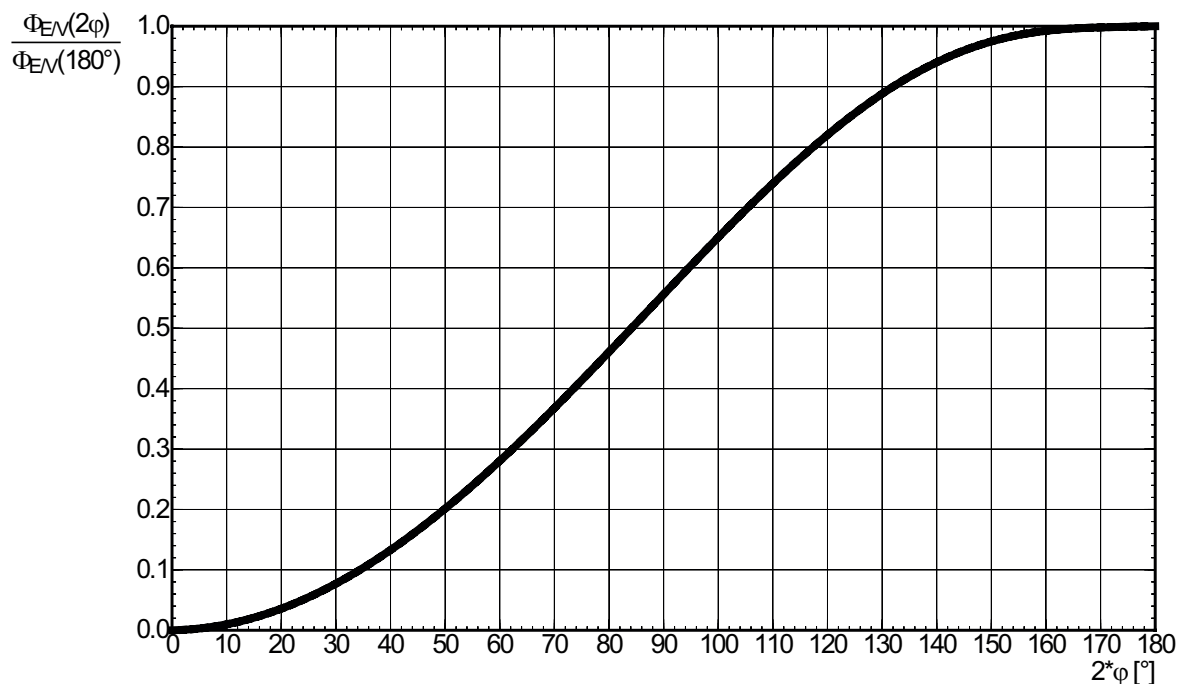

### Relative Partial Flux <sup>4)</sup>

$\Phi_V(2\varphi)/\Phi_V(180^\circ) = f(\varphi)$ ;  $T_J = 25^\circ\text{C}$ ; ultra white

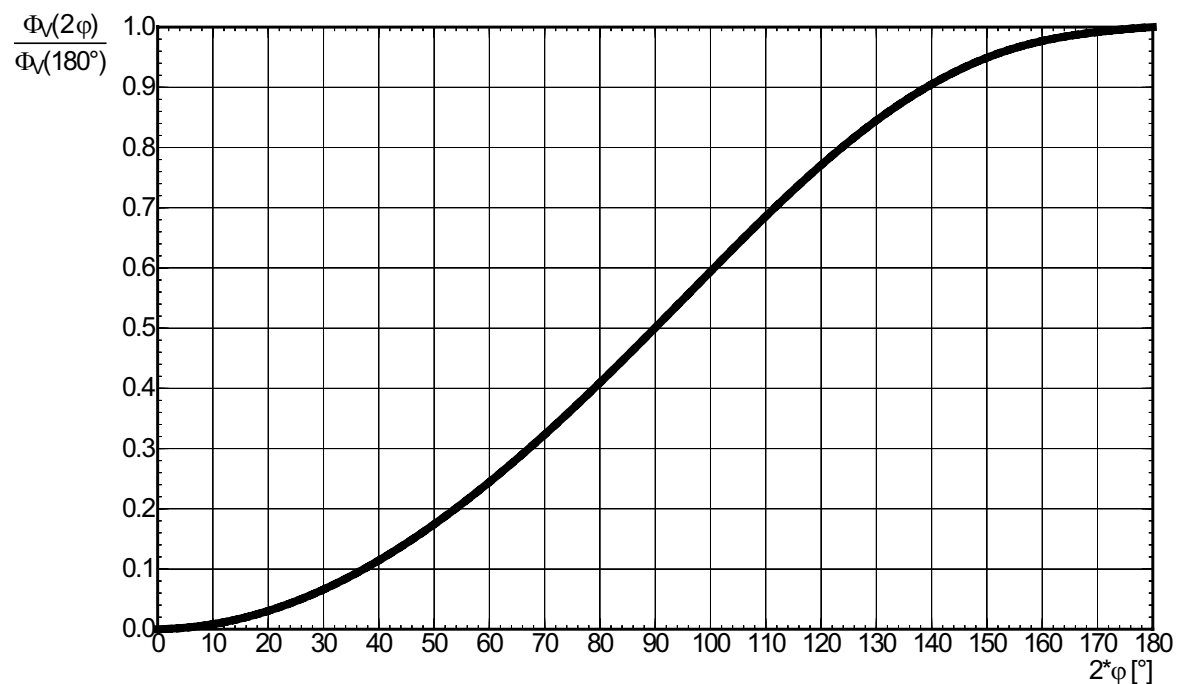

**Forward current** <sup>4)</sup>

$I_F = f(V_F); T_J = 25\text{ °C}$

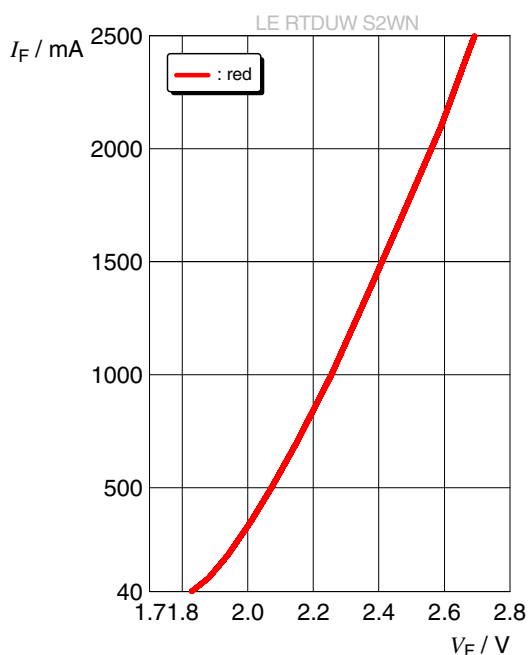

**Forward current** <sup>4)</sup>

$I_F = f(V_F); T_J = 25\text{ °C}$

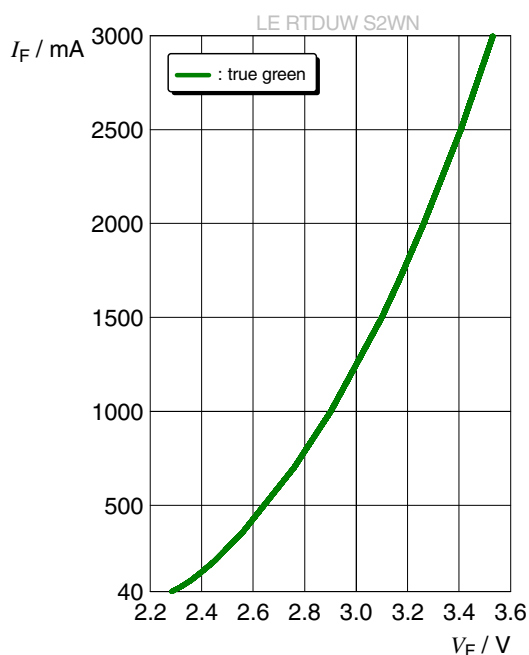

**Forward current** <sup>4), 8)</sup>

$I_F = f(V_F); T_J = 25\text{ °C}$

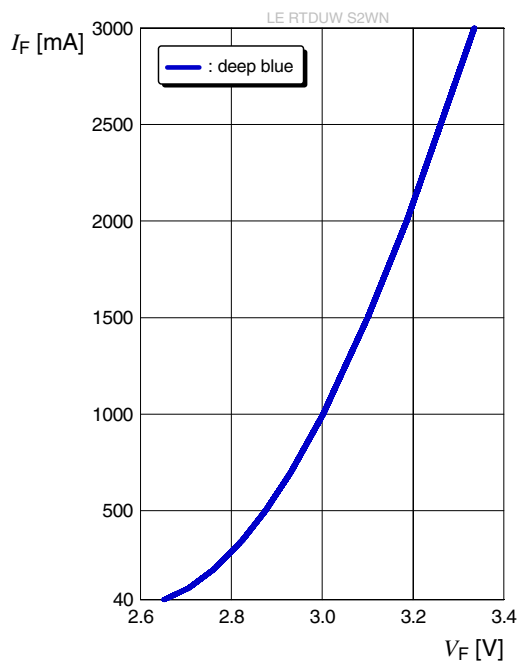

**Forward current** <sup>4), 8)</sup>

$I_F = f(V_F); T_J = 25\text{ °C}$

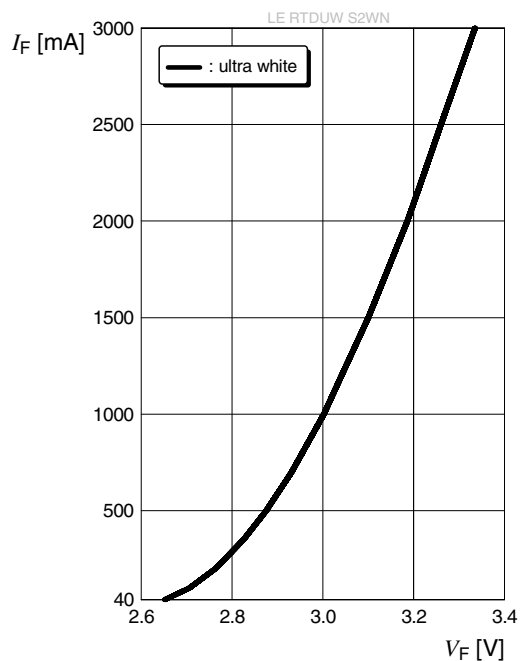

### Relative Luminous Flux <sup>4), 8)</sup>

$$\Phi_V / \Phi_V(1000 \text{ mA}) = f(I_F); T_J = 25 \text{ }^\circ\text{C}$$

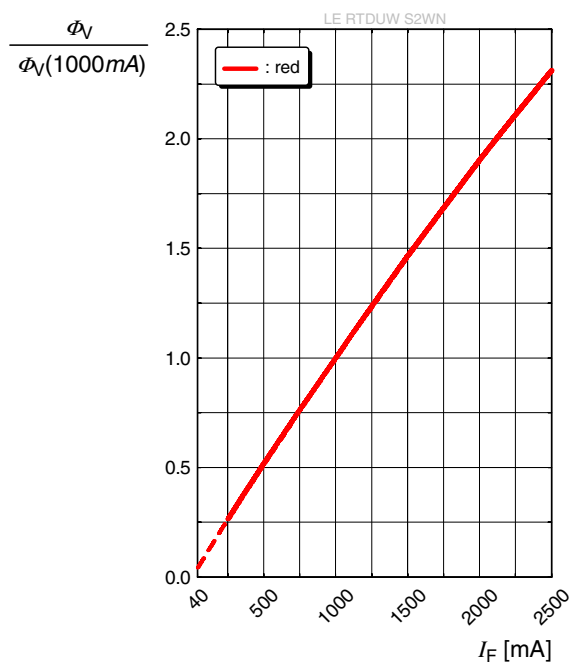

### Relative Luminous Flux <sup>4), 8)</sup>

$$\Phi_V / \Phi_V(1000 \text{ mA}) = f(I_F); T_J = 25 \text{ }^\circ\text{C}$$

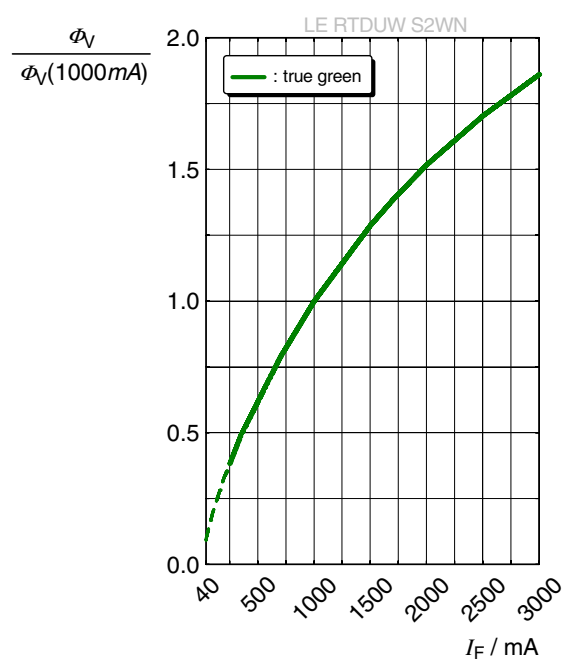

### Relative Radiant Power <sup>4), 8)</sup>

$$\Phi_E / \Phi_E(1000 \text{ mA}) = f(I_F); T_J = 25 \text{ }^\circ\text{C}$$

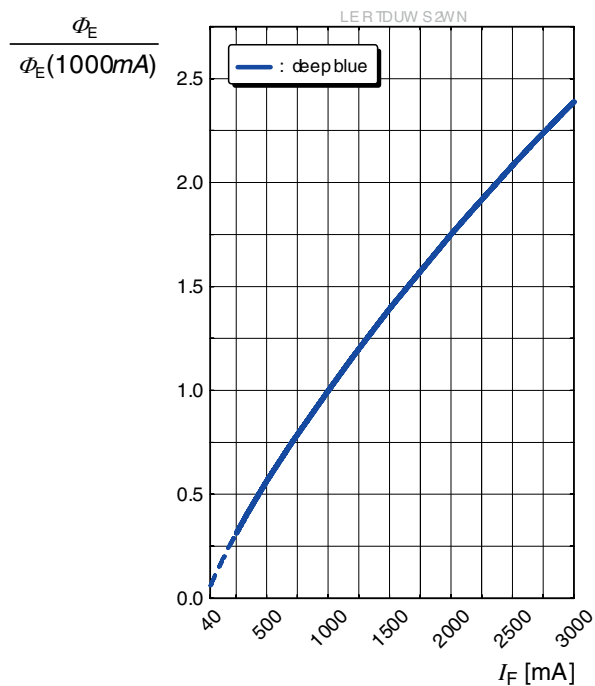

### Relative Luminous Flux <sup>4), 8)</sup>

$$\Phi_V / \Phi_V(1000 \text{ mA}) = f(I_F); T_J = 25 \text{ }^\circ\text{C}$$

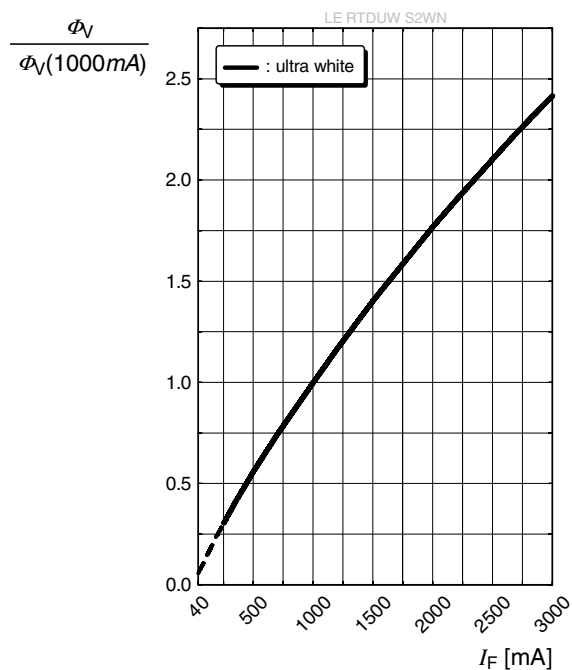

### Dominant Wavelength <sup>4)</sup>

$$\Delta\lambda_{\text{dom}} = f(I_F); T_J = 25\text{ }^\circ\text{C}$$

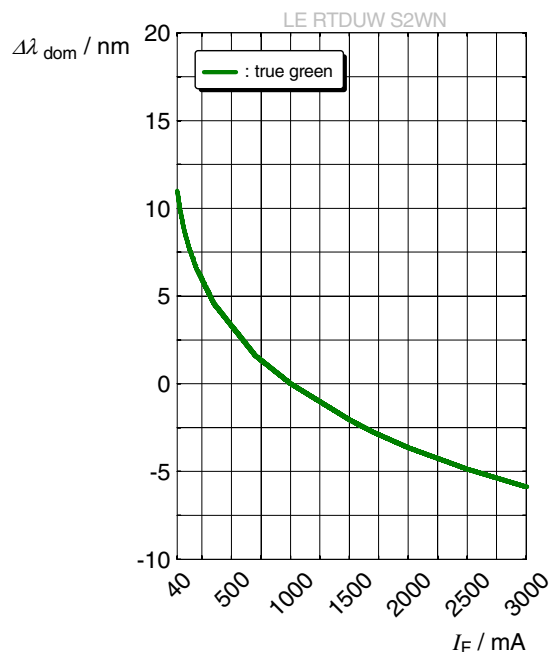

### Dominant Wavelength <sup>4)</sup>

$$\Delta\lambda_{\text{dom}} = f(I_F); T_J = 25\text{ }^\circ\text{C}$$

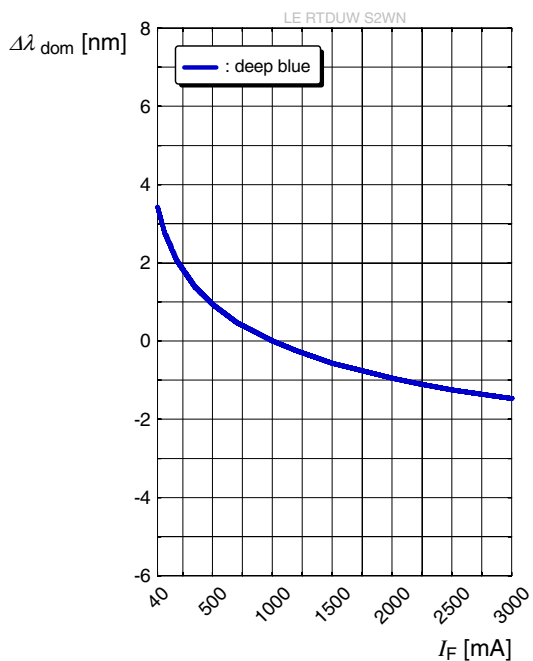

### Chromaticity Coordinate Shift <sup>4)</sup>

$$\Delta Cx, \Delta Cy = f(I_F); T_J = 25\text{ }^\circ\text{C}$$

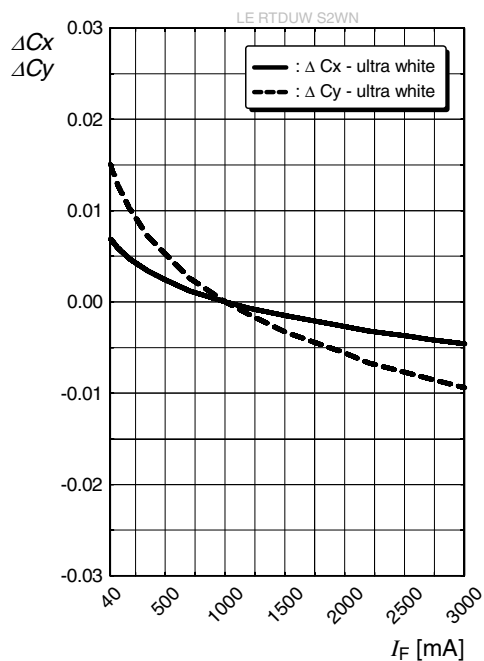

### Forward Voltage <sup>4)</sup>

$$\Delta V_F = V_F - V_F(25\text{ °C}) = f(T_j); I_F = 1000\text{ mA}$$

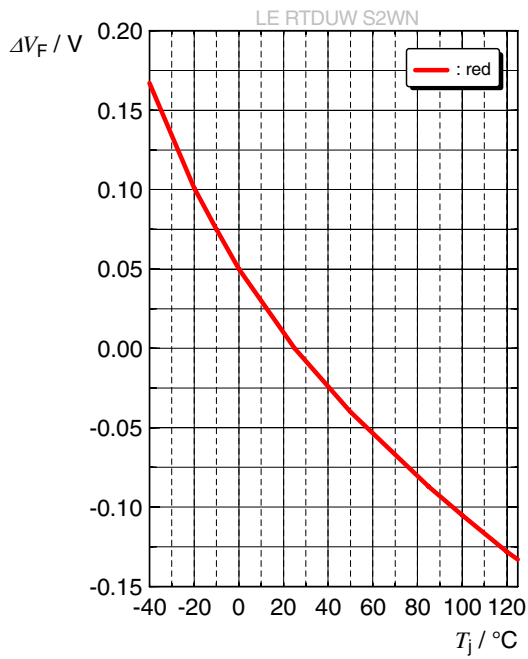

### Forward Voltage <sup>4)</sup>

$$\Delta V_F = V_F - V_F(25\text{ °C}) = f(T_j); I_F = 1000\text{ mA}$$

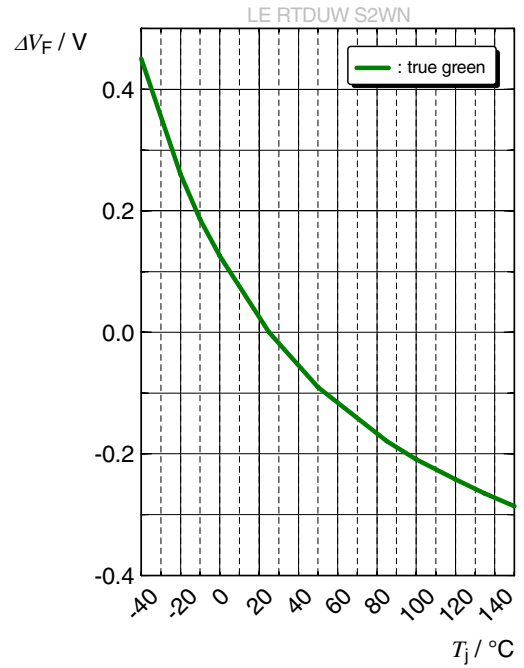

### Forward Voltage <sup>4)</sup>

$$\Delta V_F = V_F - V_F(25\text{ °C}) = f(T_j); I_F = 1000\text{ mA}$$

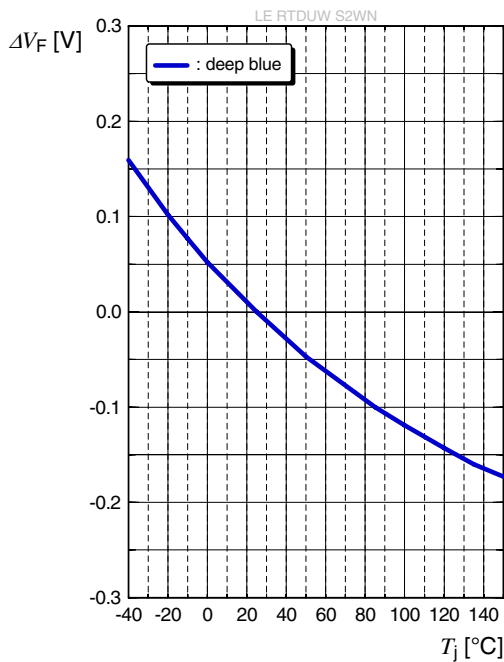

### Forward Voltage <sup>4)</sup>

$$\Delta V_F = V_F - V_F(25\text{ °C}) = f(T_j); I_F = 1000\text{ mA}$$

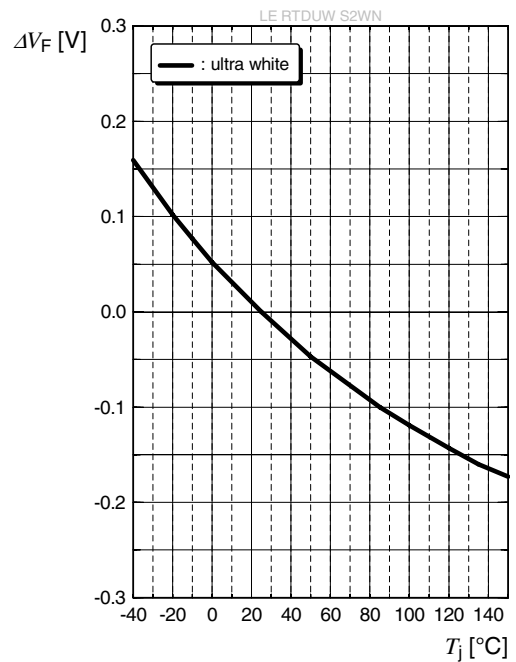

### Relative Luminous Flux <sup>4)</sup>

$$\Phi_V / \Phi_V(25^\circ\text{C}) = f(T_j); I_F = 1000\text{ mA}$$

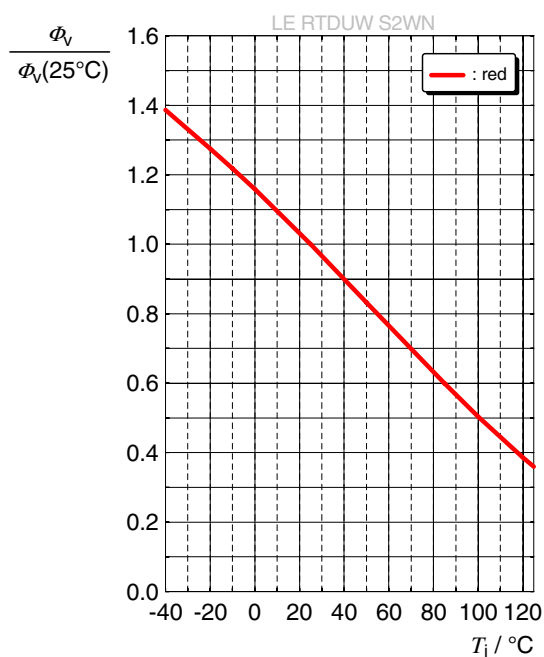

### Relative Luminous Flux <sup>4)</sup>

$$\Phi_V / \Phi_V(25^\circ\text{C}) = f(T_j); I_F = 1000\text{ mA}$$

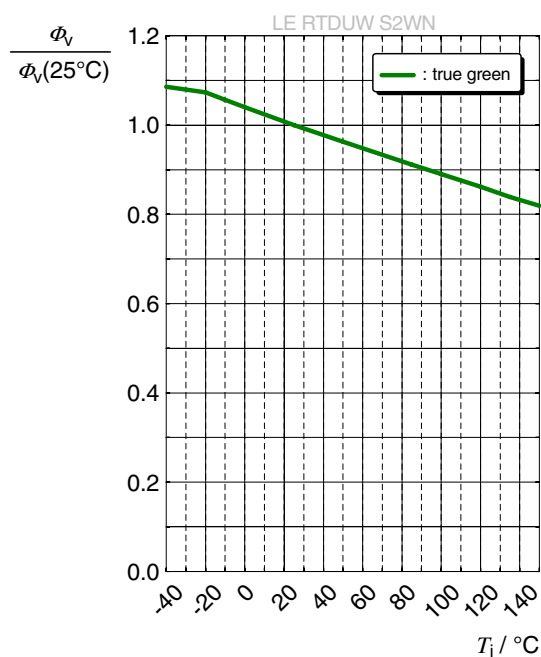

### Relative Radiant Power <sup>4)</sup>

$$\Phi_E / \Phi_E(25^\circ\text{C}) = f(T_j); I_F = 1000\text{ mA}$$

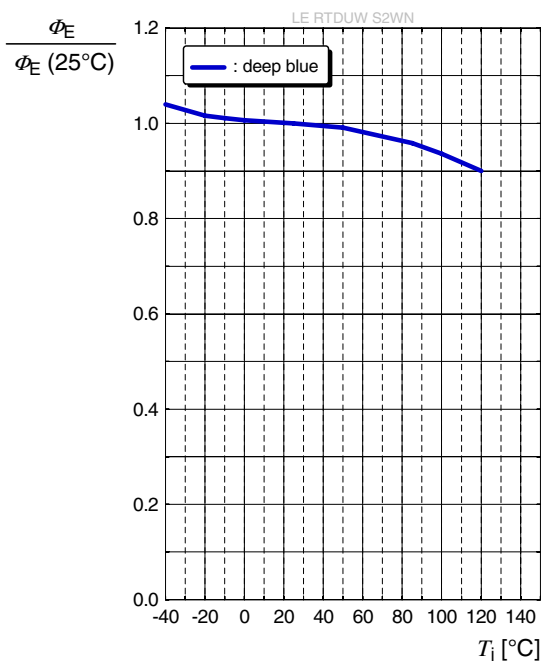

### Relative Luminous Flux <sup>4)</sup>

$$\Phi_V / \Phi_V(25^\circ\text{C}) = f(T_j); I_F = 1000\text{ mA}$$

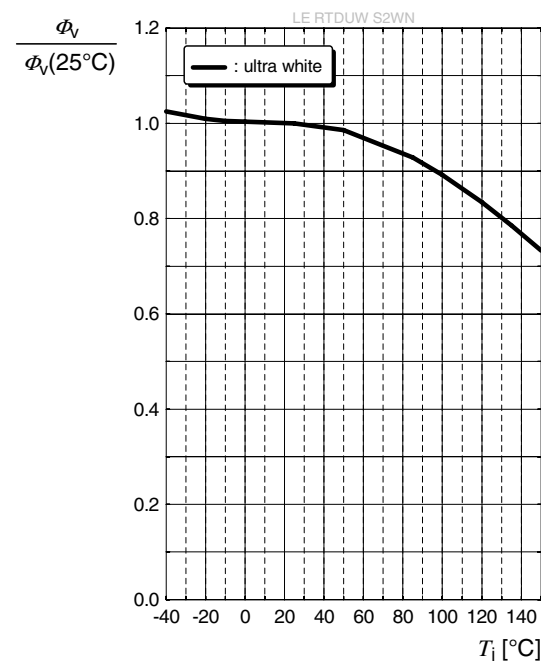



### Dominant Wavelength <sup>4)</sup>

$$\Delta\lambda_{\text{dom}} = \lambda_{\text{dom}} - \lambda_{\text{dom}}(25\text{ °C}) = f(T_j); I_F = 1000\text{ mA}$$

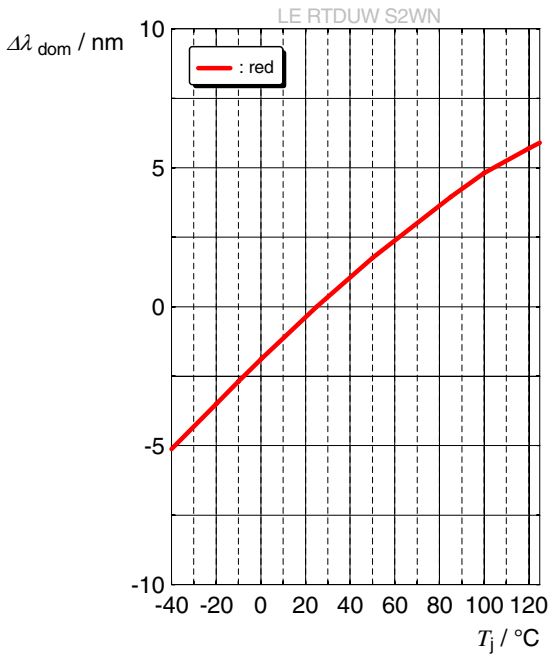

### Dominant Wavelength <sup>4)</sup>

$$\Delta\lambda_{\text{dom}} = \lambda_{\text{dom}} - \lambda_{\text{dom}}(25\text{ °C}) = f(T_j); I_F = 1000\text{ mA}$$

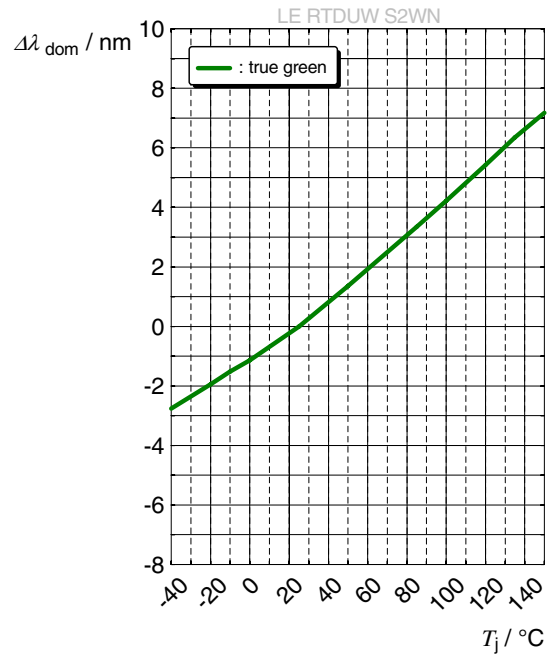

### Dominant Wavelength <sup>4)</sup>

$$\Delta\lambda_{\text{dom}} = \lambda_{\text{dom}} - \lambda_{\text{dom}}(25\text{ °C}) = f(T_j); I_F = 1000\text{ mA}$$

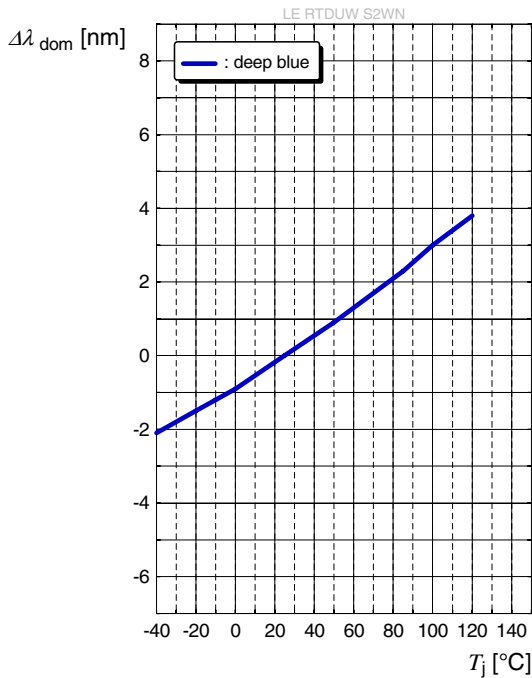

### Chromaticity Coordinate Shift <sup>4)</sup>

$$\Delta C_x, \Delta C_y = f(T_j); I_F = 1000\text{ mA}$$

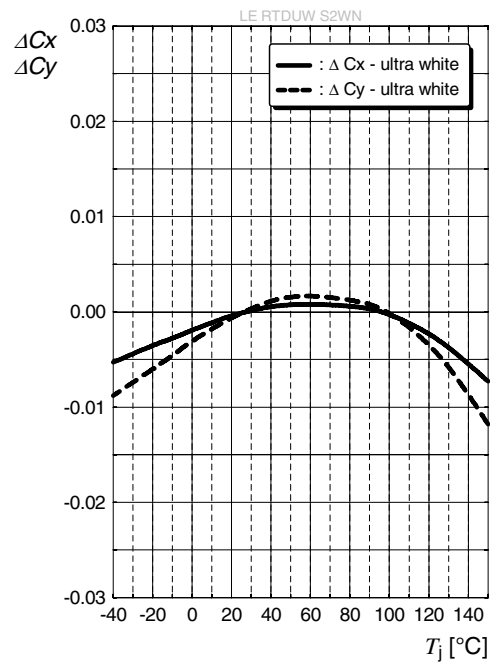

### Max. Permissible Forward Current

$I_F = f(T)$ ; 4 Chips operated; current per Chip

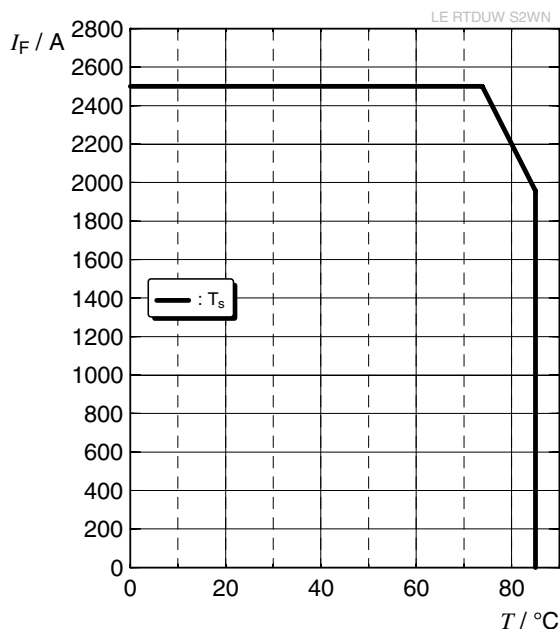

### Permissible Pulse Handling Capability

$I_F = f(T)$ ; 4 Chips operated; current per Chip

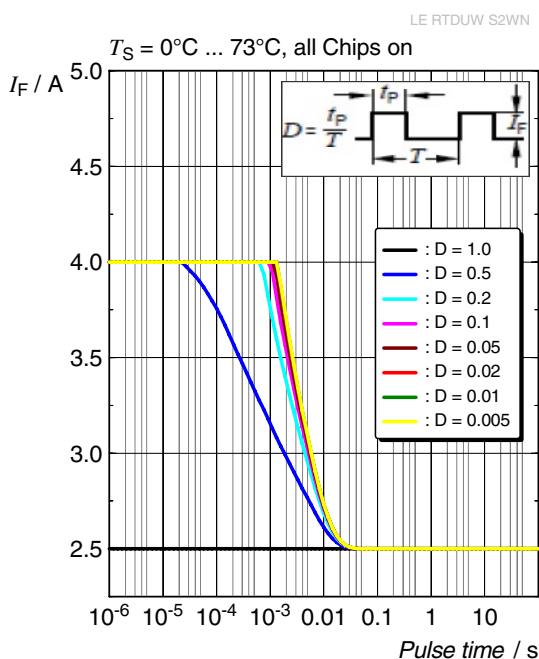

### Permissible Pulse Handling Capability

$I_F = f(T)$ ; 4 Chips operated; current per Chip

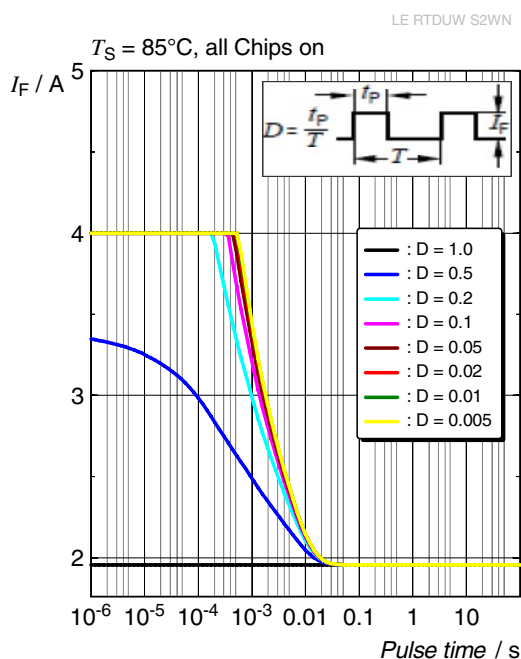

## Dimensional Drawing <sup>9)</sup>

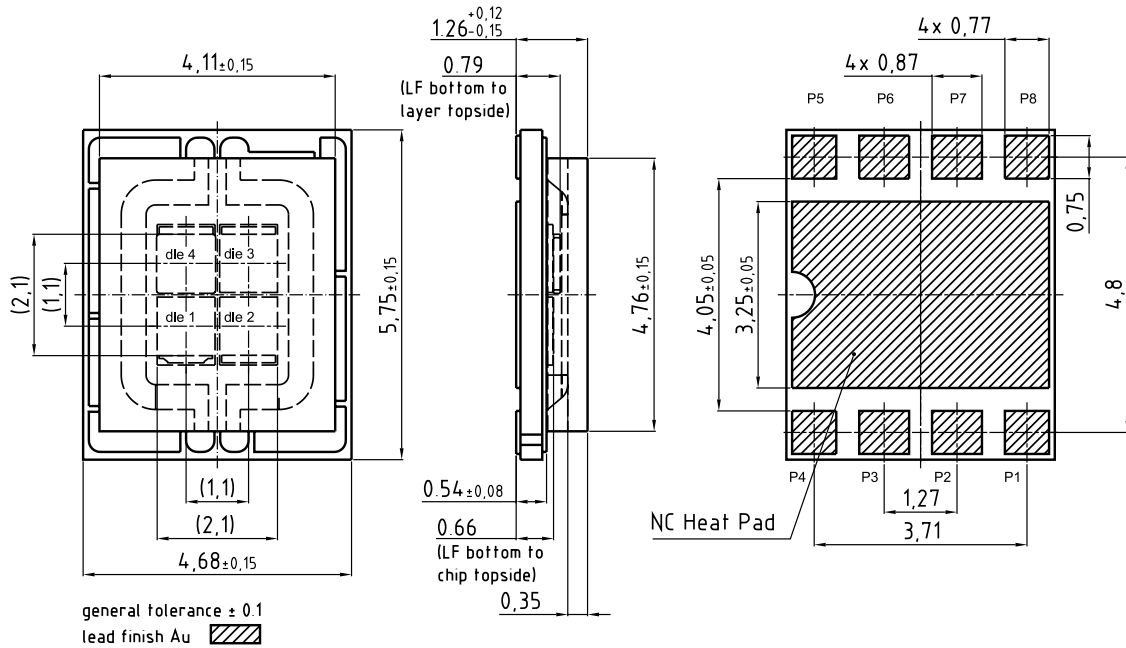

C63062-A4278-A1-04

## Further Information:

**Approximate Weight:** 91.0 mg

**Corrosion test:** Class: 3B  
Test condition:  $40^{\circ}\text{C}$  / 90 % RH / 15 ppm  $\text{H}_2\text{S}$  / 14 days (stricter than IEC 60068-2-43)

**ESD advice:** The device is protected by ESD device which is connected in parallel to the Chip.

## Electrical Internal Circuit

Pinning :

P1 Cathode die 1

P2 Anode die 1

P3 Cathode die 2

P4 Anode die 2

P5 Cathode die 3

P6 Anode die 3

P7 Cathode die 4

P8 Anode die 4

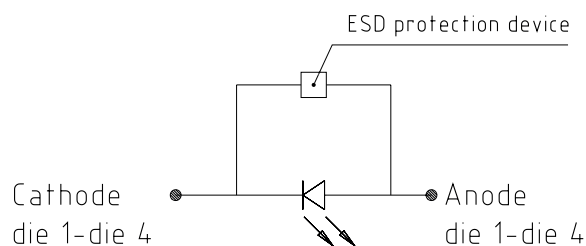

Colors :

die 1: red

die 2: deep blue

die 3: true green

die 4: ultra white

## Recommended Solder Pad <sup>9)</sup>

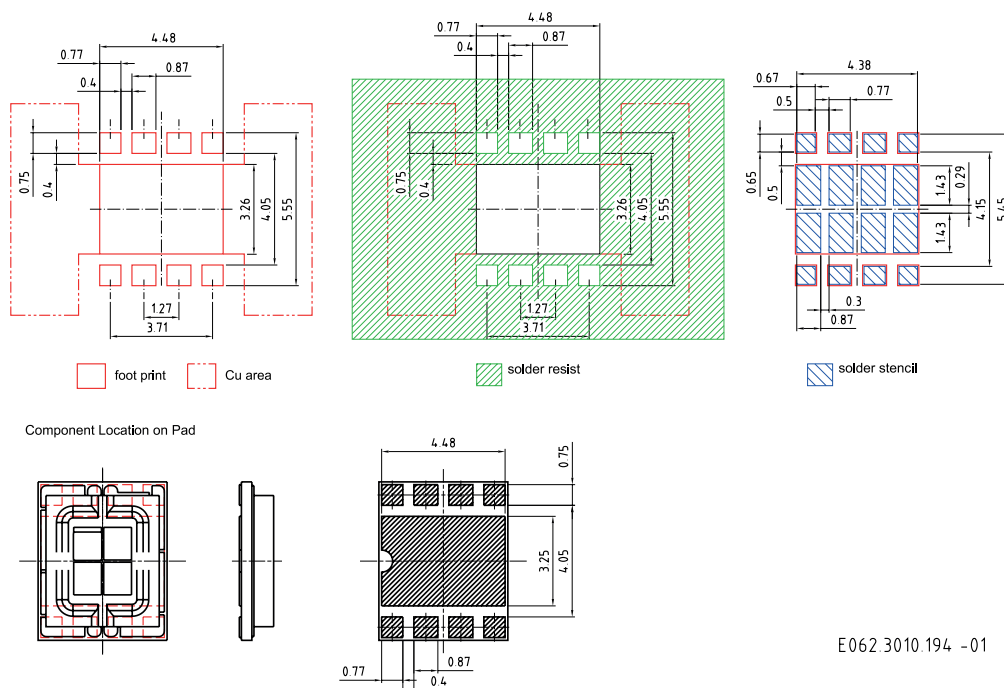

E062.3010.194 -01

For superior solder joint connectivity results we recommend soldering under standard nitrogen atmosphere. Package not suitable for any kind of wet cleaning or ultrasonic cleaning.

## Reflow Soldering Profile

Product complies to MSL Level 2 acc. to JEDEC J-STD-020E

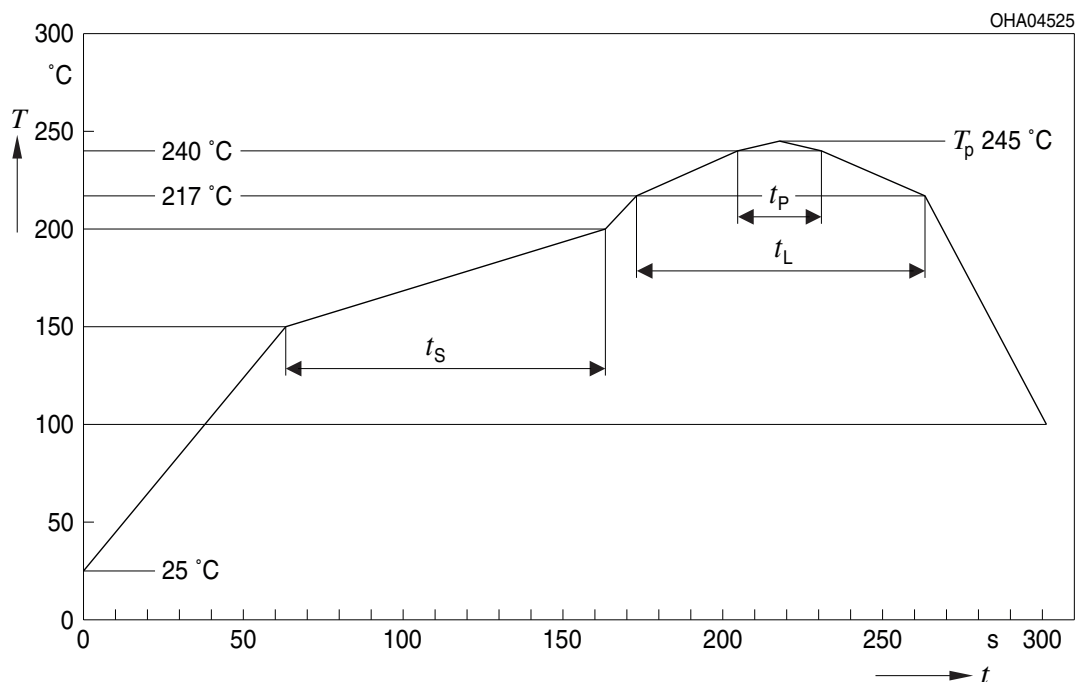

Profile Feature	Symbol	Pb-Free (SnAgCu) Assembly			Unit
		Minimum	Recommendation	Maximum	
Ramp-up rate to preheat <sup>*)</sup> 25 °C to 150 °C			2	3	K/s
Time $t_s$ $T_{Smin}$ to $T_{Smax}$	$t_s$	60	100	120	s
Ramp-up rate to peak <sup>*)</sup> $T_{Smax}$ to $T_p$			2	3	K/s
Liquidus temperature	$T_L$		217		°C
Time above liquidus temperature	$t_L$		80	100	s
Peak temperature	$T_p$		245	260	°C
Time within 5 °C of the specified peak temperature $T_p - 5$ K	$t_p$	10	20	30	s
Ramp-down rate* $T_p$ to 100 °C			3	6	K/s
Time 25 °C to $T_p$				480	s

All temperatures refer to the center of the package, measured on the top of the component

\* slope calculation  $DT/Dt$ :  $Dt$  max. 5 s; fulfillment for the whole T-range

Taping <sup>9)</sup>

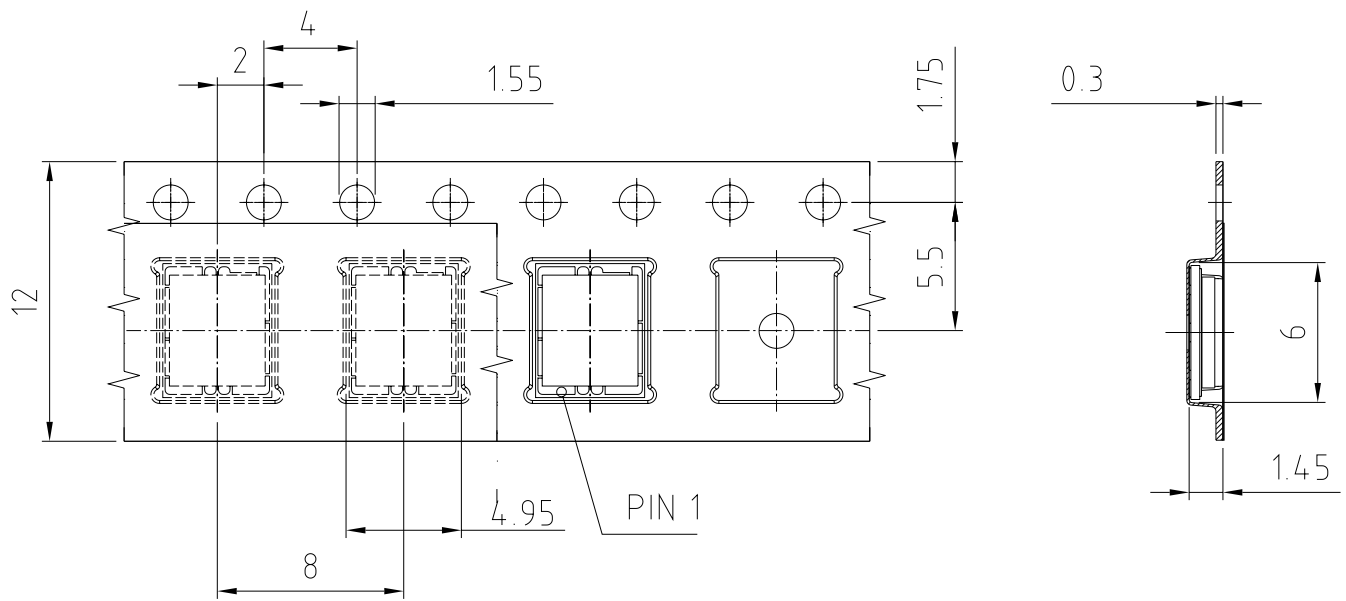

C63062-A4278-B22-01

Tape and Reel <sup>10)</sup>

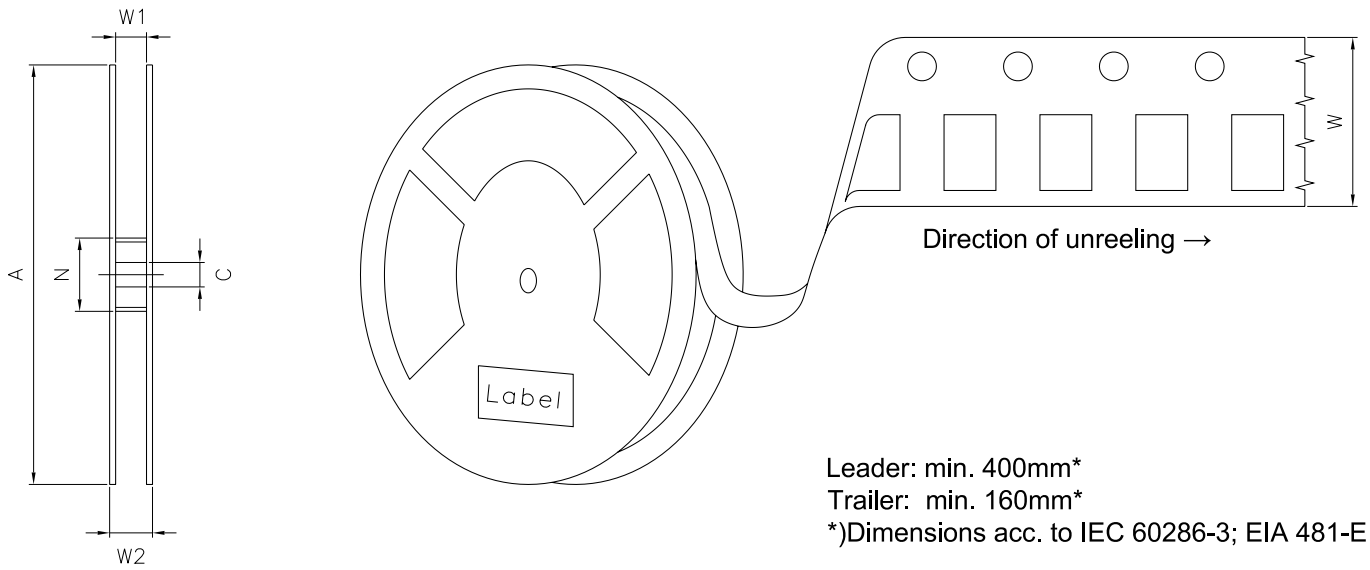

Reel Dimensions

A	W	N <sub>min</sub>	W <sub>1</sub>	W <sub>2max</sub>	Pieces per PU
180 mm	12 + 0.3 / - 0.1 mm	60 mm	12.4 + 2 mm	18.4 mm	500

### Barcode-Product-Label (BPL)

**OSRAM Opto Semiconductors** LX XXXX BIN1: XX-XX-X-XXX-X

RoHS Compliant

(6P) BATCH NO: 1234567890

(1T) LOT NO: 1234567890 (9D) D/C: 1234

(X) PROD NO: 123456789(Q)QTY: 9999 (G) GROUP: XX-XX-X-X

ML Temp ST  
X XXX °C X

Pack: RXX  
DEMY XXX  
X\_X123\_1234.1234 X

OHA04563

### Dry Packing Process and Materials <sup>9)</sup>

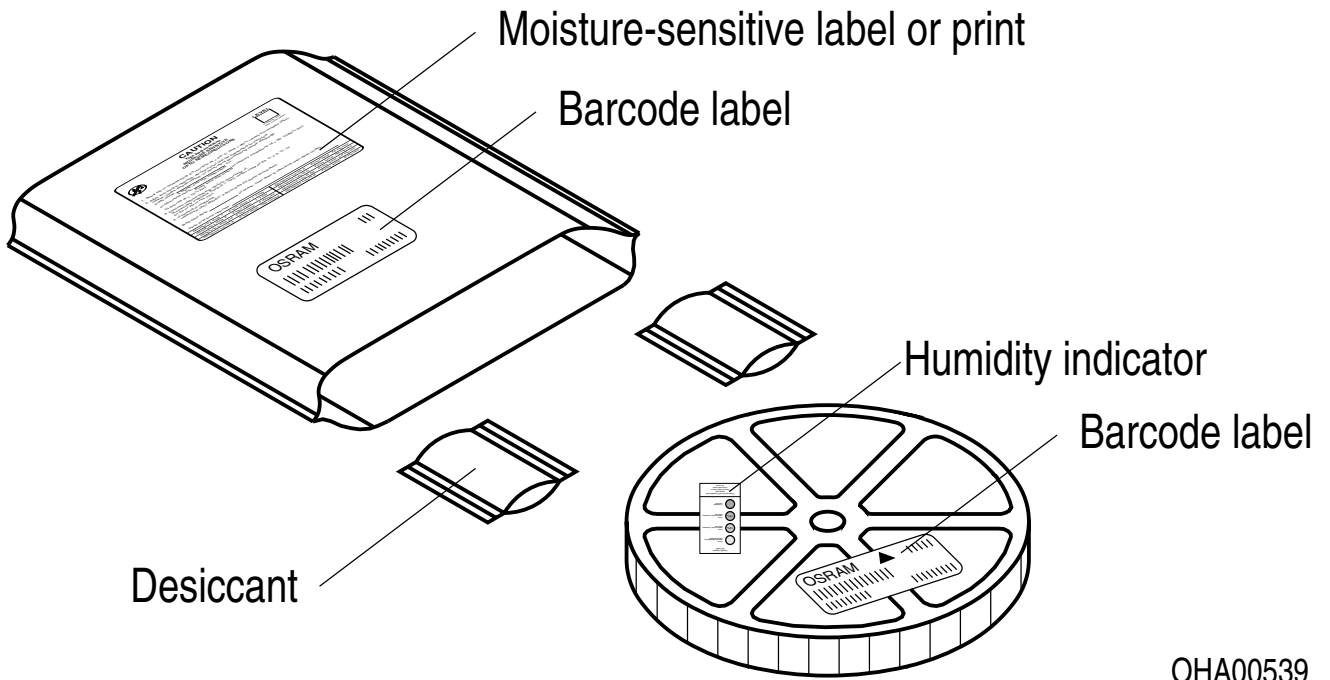

OHA00539

Moisture-sensitive product is packed in a dry bag containing desiccant and a humidity card according JEDEC-STD-033.



## Notes

The evaluation of eye safety occurs according to the standard IEC 62471:2006 (photo biological safety of lamps and lamp systems). Within the risk grouping system of this IEC standard, the device specified in this data sheet fall into the class **moderate risk (exposure time 0.25 s)**. Under real circumstances (for exposure time, conditions of the eye pupils, observation distance), it is assumed that no endangerment to the eye exists from these devices. As a matter of principle, however, it should be mentioned that intense light sources have a high secondary exposure potential due to their blinding effect. When looking at bright light sources (e.g. headlights), temporary reduction in visual acuity and afterimages can occur, leading to irritation, annoyance, visual impairment, and even accidents, depending on the situation.

Subcomponents of this device contain, in addition to other substances, metal filled materials including silver. Metal filled materials can be affected by environments that contain traces of aggressive substances. Therefore, we recommend that customers minimize device exposure to aggressive substances during storage, production, and use. Devices that showed visible discoloration when tested using the described tests above did show no performance deviations within failure limits during the stated test duration. Respective failure limits are described in the IEC60810.

For further application related information please visit [www.osram-os.com/appnotes](http://www.osram-os.com/appnotes)

## Disclaimer

### Attention please!

The information describes the type of component and shall not be considered as assured characteristics. Terms of delivery and rights to change design reserved. Due to technical requirements components may contain dangerous substances.

For information on the types in question please contact our Sales Organization.

If printed or downloaded, please find the latest version on our website.

### Packing

Please use the recycling operators known to you. We can also help you – get in touch with your nearest sales office. By agreement we will take packing material back, if it is sorted. You must bear the costs of transport. For packing material that is returned to us unsorted or which we are not obliged to accept, we shall have to invoice you for any costs incurred.

### Product and functional safety devices/applications or medical devices/applications

Our components are not developed, constructed or tested for the application as safety relevant component or for the application in medical devices.

Our products are not qualified at module and system level for such application.

In case buyer – or customer supplied by buyer – considers using our components in product safety devices/applications or medical devices/applications, buyer and/or customer has to inform our local sales partner immediately and we and buyer and /or customer will analyze and coordinate the customer-specific request between us and buyer and/or customer.

## Glossary

- 1) **Reverse Operation:** This product is intended to be operated applying a forward current within the specified range. Applying any continuous reverse bias or forward bias below the voltage range of light emission shall be avoided because it may cause migration which can change the electro-optical characteristics or damage the LED.
- 2) **Chromaticity coordinate groups:** Chromaticity coordinates are measured during a current pulse of typically 25 ms, with an internal reproducibility of  $\pm 0.005$  and an expanded uncertainty of  $\pm 0.01$  (acc. to GUM with a coverage factor of  $k = 3$ ).
- 3) **Wavelength:** The wavelength is measured at a current pulse of typically 25 ms, with an internal reproducibility of  $\pm 0.5$  nm and an expanded uncertainty of  $\pm 1$  nm (acc. to GUM with a coverage factor of  $k = 3$ ).
- 4) **Typical Values:** Due to the special conditions of the manufacturing processes of semiconductor devices, the typical data or calculated correlations of technical parameters can only reflect statistical figures. These do not necessarily correspond to the actual parameters of each single product, which could differ from the typical data and calculated correlations or the typical characteristic line. If requested, e.g. because of technical improvements, these typ. data will be changed without any further notice.
- 5) **Forward Voltage:** The forward voltage is measured during a current pulse of typically 8 ms, with an internal reproducibility of  $\pm 0.05$  V and an expanded uncertainty of  $\pm 0.1$  V (acc. to GUM with a coverage factor of  $k = 3$ ).
- 6) **Thermal Resistance:**  $R_{th\ max}$  is based on statistic values ( $6\sigma$ ).
- 7) **Brightness:** Brightness values are measured during a current pulse of typically 25 ms, with an internal reproducibility of  $\pm 8$  % and an expanded uncertainty of  $\pm 11$  % (acc. to GUM with a coverage factor of  $k = 3$ ).
- 8) **Characteristic curve:** In the range where the line of the graph is broken, you must expect higher differences between single devices within one packing unit.
- 9) **Tolerance of Measure:** Unless otherwise noted in drawing, tolerances are specified with  $\pm 0.1$  and dimensions are specified in mm.
- 10) **Tape and Reel:** All dimensions and tolerances are specified acc. IEC 60286-3 and specified in mm.

---

## Revision History

Version	Date	Change
1.5	2019-02-07	Dimensional Drawing
1.6	2019-06-06	Electro - Optical Characteristics (Diagrams)
1.7	2020-06-03	Schematic Transportation Box Dimensions of Transportation Box
1.8	2020-07-07	Characteristics
1.9	2021-04-29	Characteristics Ordering Information Chromaticity Coordinate Groups Wavelength Groups
1.9	2021-11-16	Ordering Information
1.10	2022-08-22	Ordering Information New Layout Characteristics Electro - Optical Characteristics (Diagrams)

---



EU RoHS and China RoHS compliant product

此产品符合欧盟 RoHS 指令的要求；  
按照中国的相关法规和标准，  
不含有毒有害物质或元素。

**Published by ams-OSRAM AG**

Tobelbader Strasse 30, 8141 Premstaetten, Austria

Phone +43 3136 500-0

[ams-osram.com](http://ams-osram.com)

© All rights reserved

**am** 

**OSRAM**