



A Product Line of
Diodes Incorporated



SPECIFICATION FOR APPROVAL

CUSTOMER _____

NOMINAL FREQUENCY 156.244531 MHz



PRODUCT TYPE TYPE LD 5.0x3.2 SEAM SEALED CRYSTAL CLOCK OSCILLATOR

SPEC. NO. (P/N) LDF620011

CUSTOMER P/N _____

ISSUE DATE April 26, 2019

VERSION B

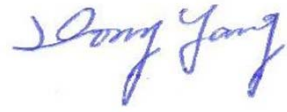
APPROVED	PREPARED	QA
		

Diodes Incorporated

No.2, Ziqiang 5th Rd., Zhongli Industrial Park,
Zhongli Dist., Taoyuan City 32063, Taiwan (R.O.C.)
TEL: 886-3-451-8888
FAX: 886-3-461-3865
<https://www.diodes.com>

- *Pb-free
- *RoHS Compliant
- *HF-Halogen Free
- *REACH Compliant

TYPE LD 5.0x3.2 SEAM SEALED CRYSTAL CLOCK OSCILLATOR

LDF620011

VER. B 26-Apr-19

ELECTRICAL SPECIFICATIONS

SRe Part Number : LDF620011

Item	Symbol	Specifications	Units	Notes
Nominal Frequency	F ₀	156.244531	MHz	
Frequency Stability	FT	± 20	ppm	**See note
Operating Temperature Range	TR	-20 to +70	°C	
Supply Voltage	V _{CC}	+3.3 ± 10.0%	V	
Logic Type	LT	LVDS		
Supply Current, Output Enabled	I _{CC/OE}	80	mA	Max.
Supply Current, Output Disabled	I _{CC/OD}	30	uA	Max.
Duty Cycle (Symmetry)	DC/SY	45 / 55	%	Measured 50% of Waveform
Rise / Fall Time	T _R /T _F	0.8	ns	Max. measured 20/80% of Waveform
Output Voltage "0" Level	V _{OL}	1.10 / 0.9	V	Typ. / Min.
Output Voltage "1" Level	V _{OH}	1.43 / 1.6	V	Typ. / Max.
Output Load		100Ω & 5pF LVDS		
Differential Output Voltage		247 / 454	mV	Min. / Max.
Jitter, Phase	RMS	1	ps	Max., 12KHz ~ 20MHz Frequency Band
Jitter, Accumulated	RMS(1-σ)	4	ps	Typ. 20,000 Consecutive Periods
Jitter, Peak to Peak	Pk-Pk	40	ps	Max. 100,000 Random Periods
Start Up Time		10	ms	Max.
Storage Temperature Range		-55 to +125	°C	

※ This product doesn't include harmful substance that stipulated by SONY SS-00259 Level 1 and S-AT2-001 Level 1 standard. RoHS Compliant (Pb - Free).

**Stability includes all combinations of Operating Temperature, Load changes, rated Input (Supply) Voltage changes, Initial Calibration Tolerance (25°C), Aging (5 years at 40°C Average Effective Ambient Temperature), Shock and Vibration.

Output Enable / Disable Function

Parameter	Min.	Typ.	Max.	Units	Notes
Input Voltage (Pin1), Output Enable	0.7V _{CC}			V	Or Open
Input Voltage (Pin1), Output Disable (low power standby)			0.3V _{CC}	V	Output is Hi-Z
Output Disable Delay			200	ns	
Output Enable Delay			2	ms	



TYPE LD 5.0x3.2 SEAM SEALED CRYSTAL CLOCK OSCILLATOR

LDF620011

VER. B 26-Apr-19

TEST CIRCUIT

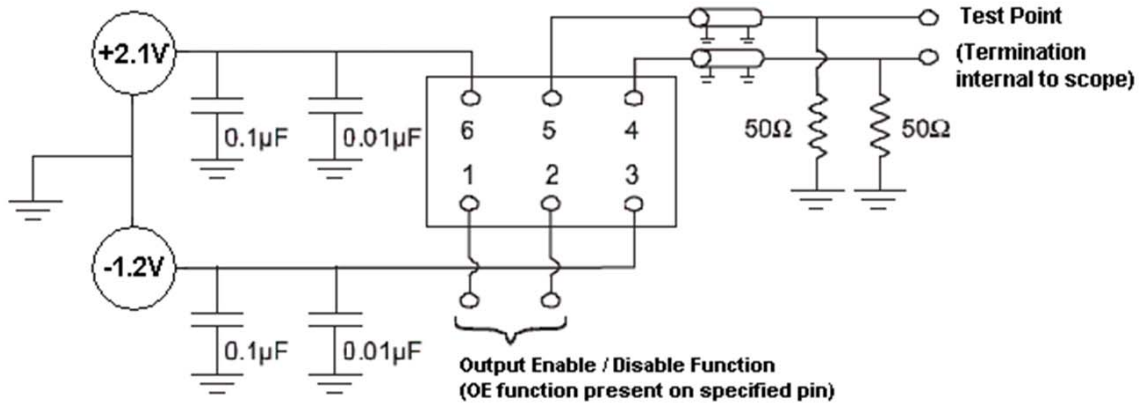

OUTPUT WAVEFORM

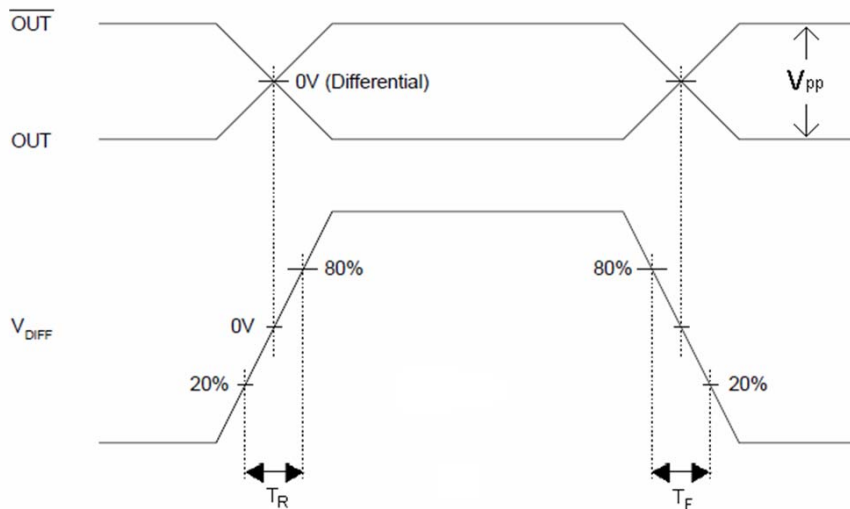
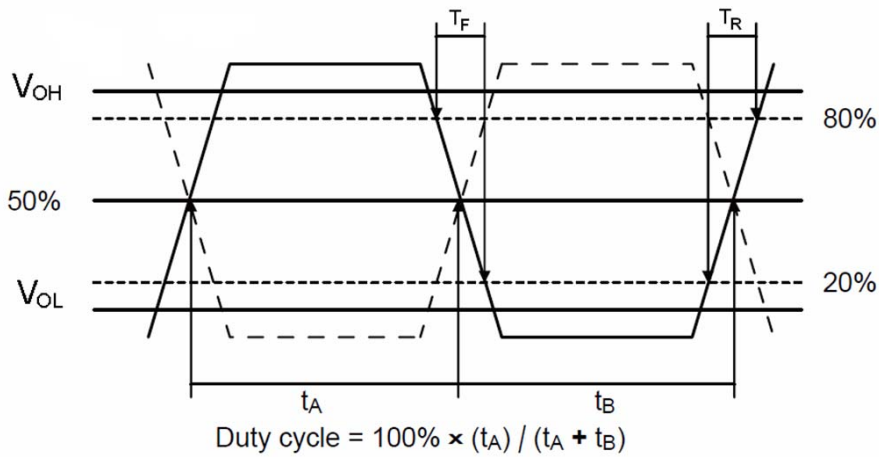

TYPE LD 5.0x3.2 SEAM SEALED CRYSTAL CLOCK OSCILLATOR

LDF620011

VER. B 26-Apr-19

RELIABILITY SPECIFICATIONS

ENVIRONMENTAL:

- a) THERMAL SHOCK: MIL-STD-883, Method 1011, Condition A
- b) MOISTURE RESISTANCE: MIL-STD-883, Method 1004
- c) VIBRATION: MIL-STD-883, Method 2007, Condition A
- d) RESISTANCE TO SOLDERING HEAT: J-STD-020D Table 5-2 Pb-free devices (except 2 cycles max)
- e) HAZARDOUS SUBSTANCE: Pb - free and RoHS/ Green Compliant.

MECHANICAL:

- a) SHOCK: MIL-STD-883, Method 2002, Condition B
- b) SOLDERABILITY: JESD22-B102-D Method 2 (Preconditioning E)
- c) TERMINAL STRENGTH: MIL-STD-883, Method 2004, Test Condition D
- d) GROSS LEAK: MIL-STD-883, Method 1014, Condition C
- e) FINE LEAK: MIL-STD-883, Method 1014, Condition A2, $R1=2 \times 10^{-8}$ atm cc/s
- f) SOLVENT RESISTANCE: MIL-STD-202, Method 215

SUGGESTED IR REFLOW PROFILE

*As per IPC-JEDEC J-STD-020D

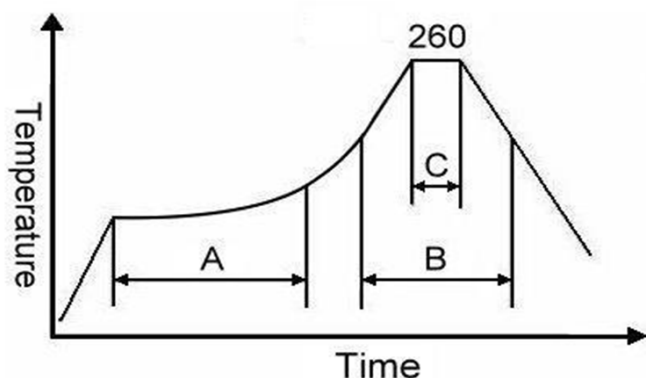

Note:

	Stage	Temperature	Time
A	Preheat	150~200°C	60~120 Sec
B	Primary Heat	217°C	60~150 Sec
C	Peak	260°C	10 Sec

TYPE LD 5.0x3.2 SEAM SEALED CRYSTAL CLOCK OSCILLATOR

LDF620011

VER. B 26-Apr-19

MARKING

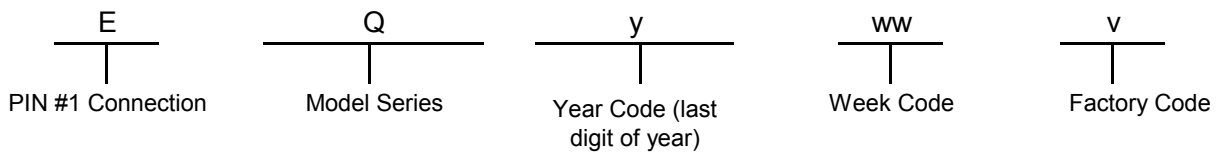
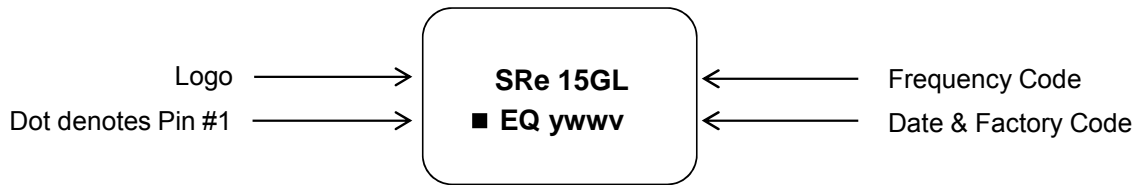

MECHANICAL DRAWINGS (Scale: None. Dimensions are in mm.)

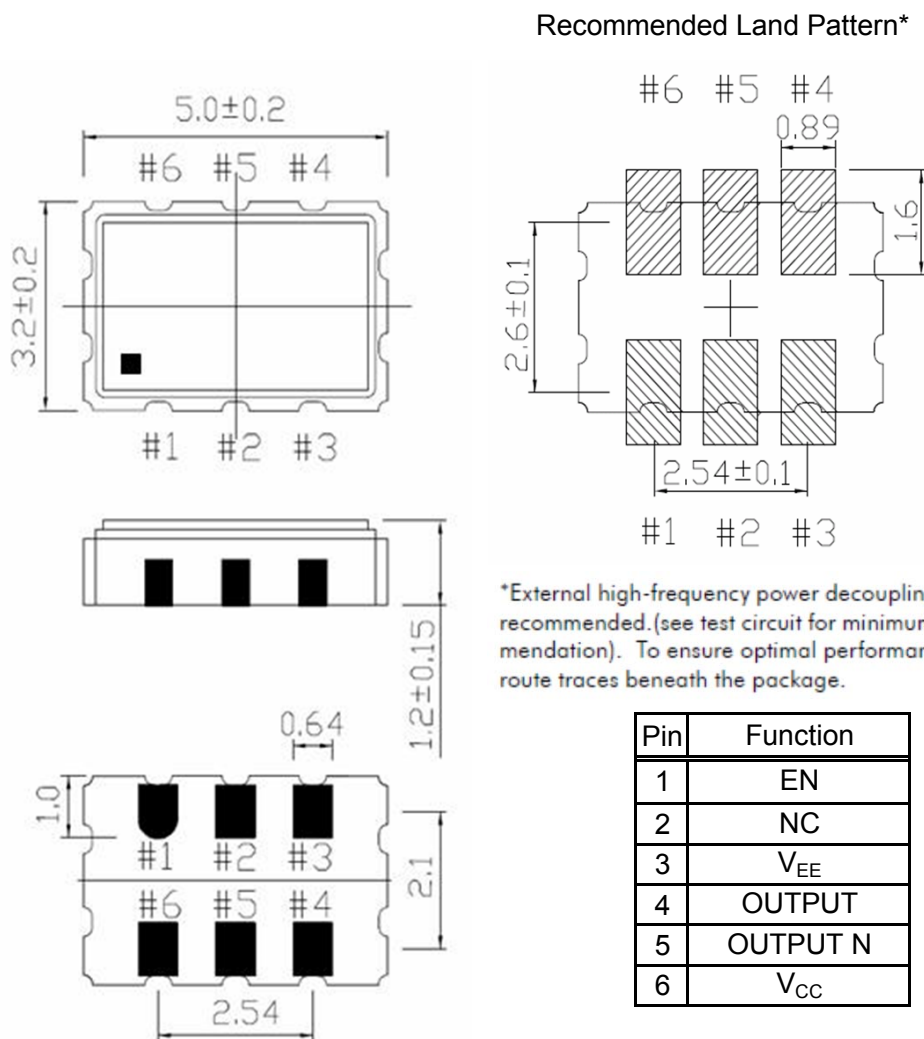

Pin	Function
1	EN
2	NC
3	V _{EE}
4	OUTPUT
5	OUTPUT N
6	V _{CC}

TYPE LD 5.0x3.2 SEAM SEALED CRYSTAL CLOCK OSCILLATOR

LDF620011

VER. B 26-Apr-19

TAPE & REEL

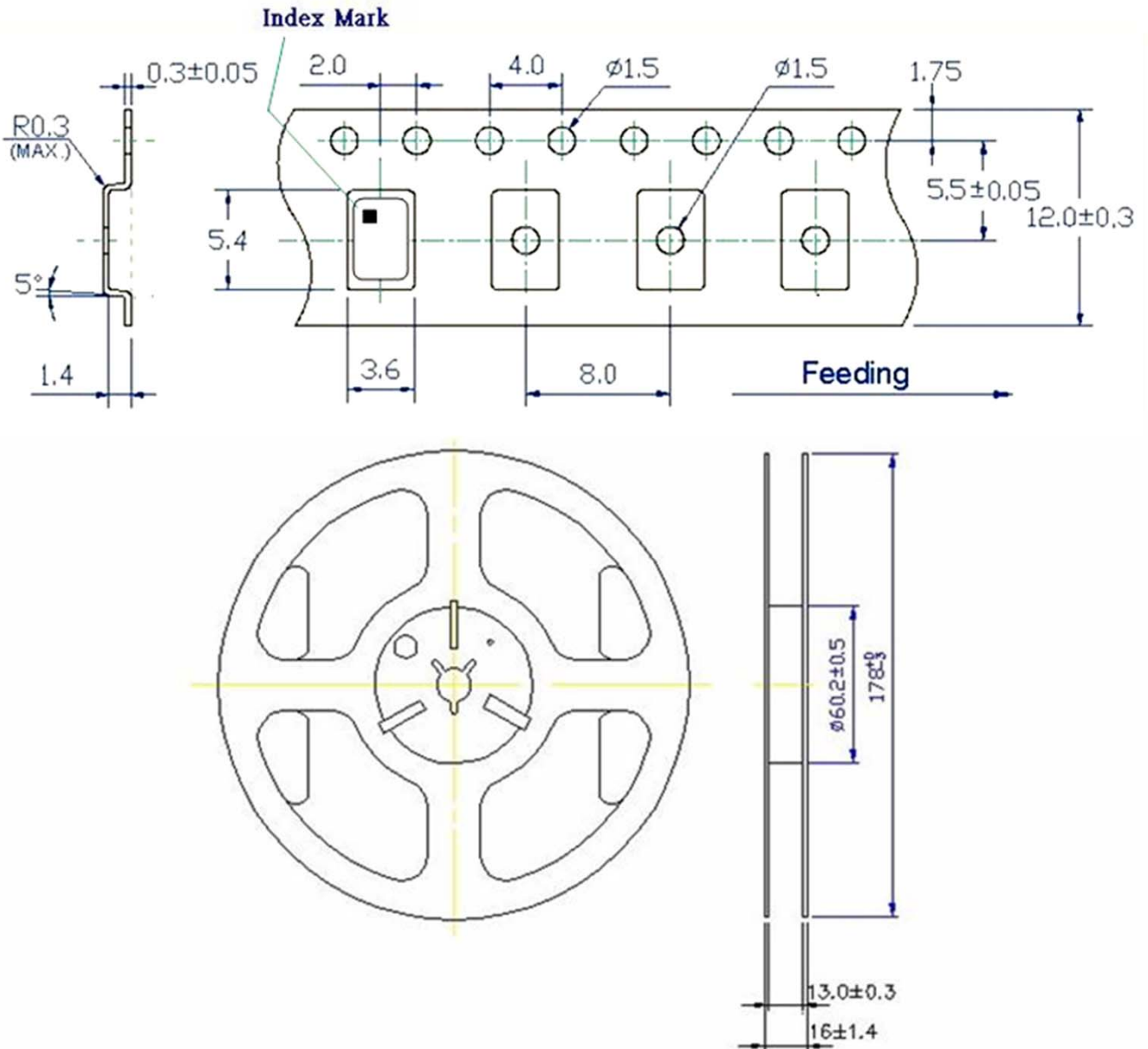

1. 230mm minimum leafer which consist of carrier and/or tape followed by a minimum of 160mm of empty carrier tape sealed with cover tape.
2. 160mm minimum trailer of empty carrier tape sealed with cover tape.

TYPE LD 5.0x3.2 SEAM SEALED CRYSTAL CLOCK OSCILLATOR

LDF620011

VER. B 26-Apr-19

PACKING

