

DATA SHEET

**ELECTROSTATIC DISCHARGE
PROTECTION DEVICES**

INDUSTRIAL / CONSUMER

LBT23C12L02

RoHS compliant & Halogen free



Product specification—June 30, 2023 V.2

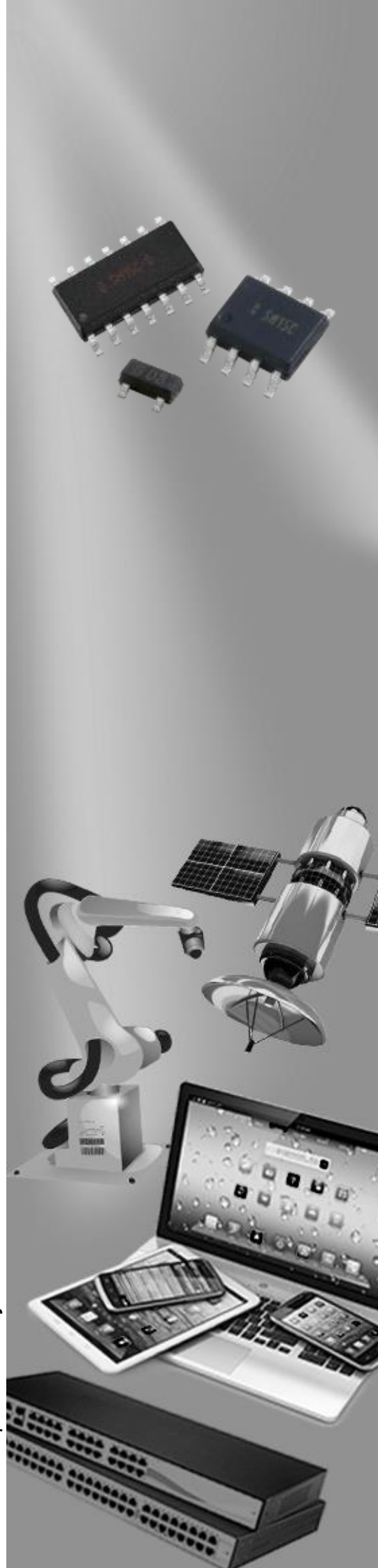

Electrostatic Discharged Protection Devices (ESD) Data Sheet

Description

Brightking's LBT23C12L02 component is designed to protect sensitive electronics from damage or latch-up due to ESD and other voltage induced transient events. It is designed for use in applications where board space is at a premium. The device will protect up to two lines. It is bidirectional devices and may be used on lines where the signal polarities are above ground. TVS diodes are solid state device designed specifically for transient suppression. It feature large cross-sectional area junctions for conduction high transient currents. It offer desirable characteristics for board level protection including fast response time, low and clamping voltage, and no device degradation. The device may be used to meet the immunity requirements of IEC61000-4-2, level 4.



Contact : $\pm 8\text{kV}$
Air : $\pm 15\text{kV}$



Features

- IEC61000-4-2 ESD 15KV Air, 8KV contact compliance
- SOT-23 surface mount package
- Protects bidirectional two I/O lines
- Peak power dissipation of 100W under 8/20 μs waveform
- Working voltage: 12V
- Low leakage current
- Low operating and clamping voltages
- Solid-state silicon avalanche technology
- Lead Free/RoHS compliant
- Solder reflow temperature: Pure Tin-Sn, 260~270 $^{\circ}\text{C}$
- Flammability rating UL 94V-0
- Meets MSL level 1, per J-STD-020
- Marking: B L12

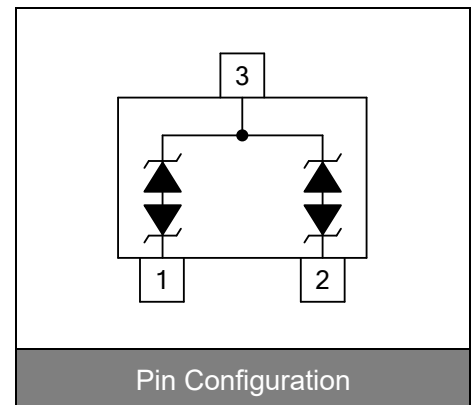

Applications

- Keypads, data lines, buttons
- Notebook computers
- Portable handheld devices
- Digital Cameras
- Portable GPS

Maximum Ratings

Rating	Symbol	Value	Unit
Peak pulse power (tp=8/20 μs waveform)	P_{PP}	100	W
ESD voltage (Contact discharge)	V_{ESD}	± 8	kV
ESD voltage (Air discharge)		± 15	
Storage & operating temperature range	T_{STG}, T_J	-55~+150	$^{\circ}\text{C}$

Electrical Characteristics (T_J=25°C)

Parameter	Symbol	Condition	Min.	Typ.	Max.	Unit
Reverse stand-off voltage	V _{RWM}				12	V
Reverse breakdown voltage	V _{BR}	I _{BR} =1mA	13.3			V
Reverse leakage current	I _R	V _R =12V Each I/O pin			1	μA
Clamping voltage (tp=8/20μs)	V _C	I _{PP} =1A			23	V
Clamping voltage (tp=8/20μs)	V _C	I _{PP} =3A			28	V
Peak pulse current (tp=8/20μs)	I _{PP}				3	A
Off state junction capacitance	C _J	0Vdc, f=1MHz Between I/O pins and GND		8	15	pF

Typical Characteristics Curves

Figure 1. Power Derating Curve

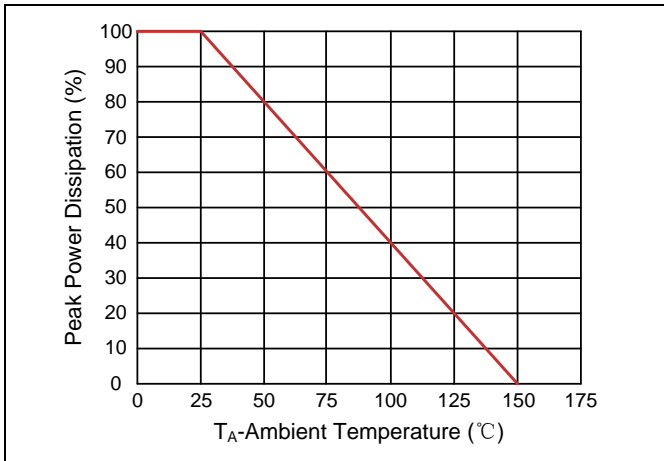

Figure 2. Pulse Waveforms

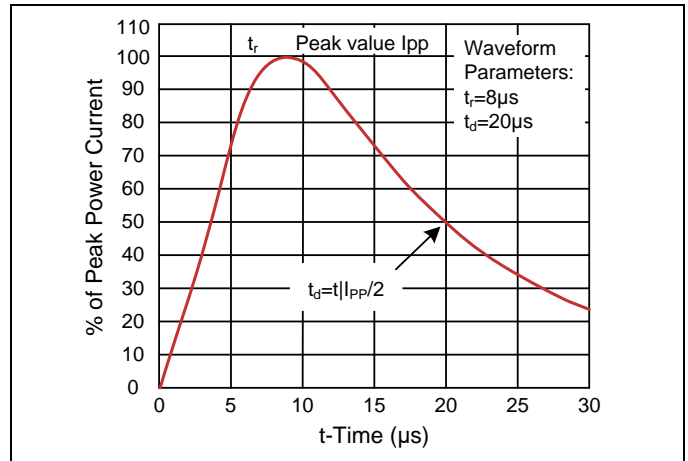

Figure 3. Clamping Voltage vs. Peak Pulse Current

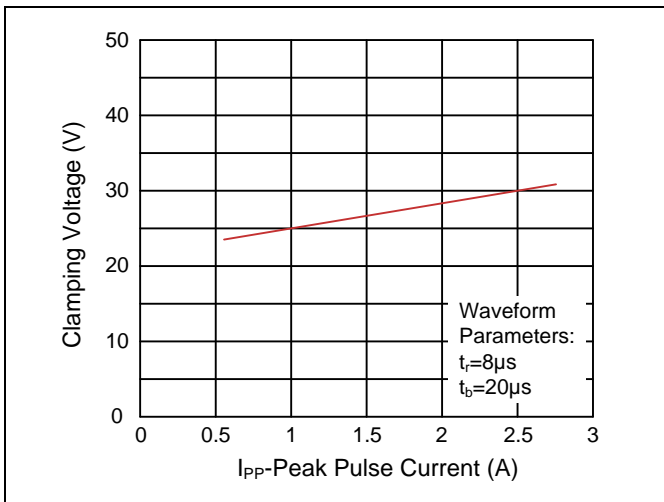
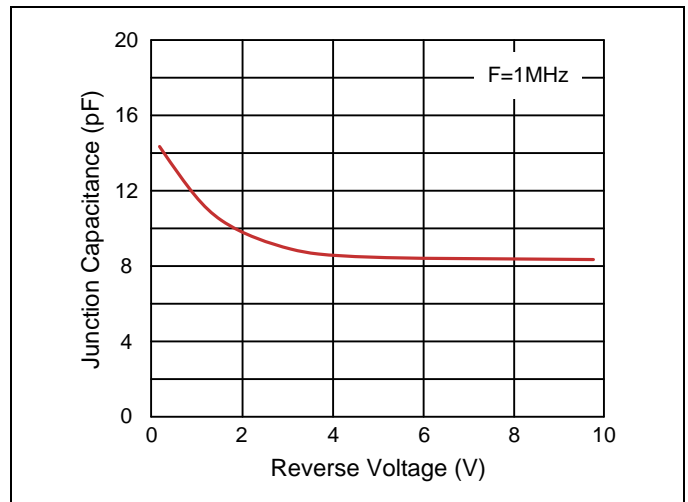
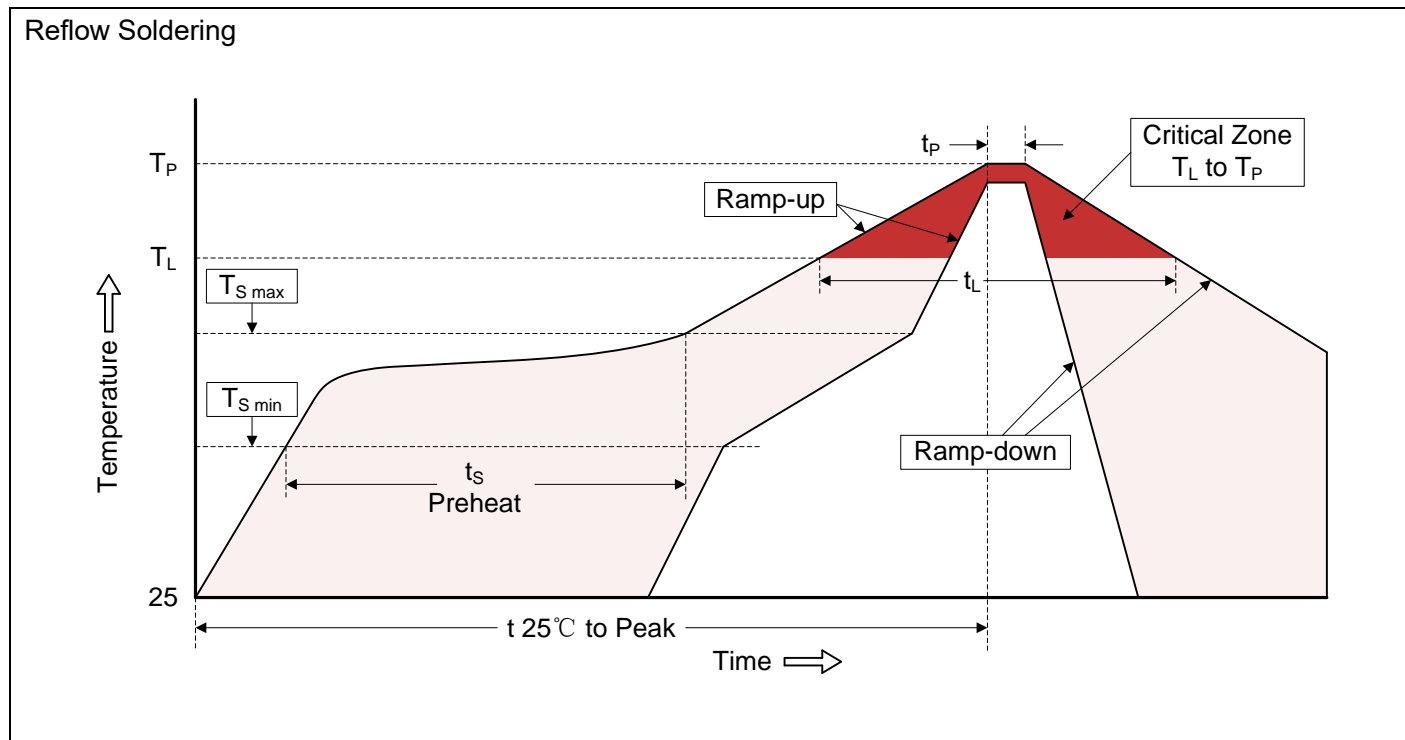

Figure 4. Normalized Capacitance vs. Reverse Voltage



Recommended Soldering Conditions



Recommended Conditions

Profile Feature	Pb-Free Assembly
Average ramp-up rate (T_L to T_P)	3°C/second max.
Preheat -Temperature Min ($T_{S\ min}$) -Temperature Max ($T_{S\ max}$) -Time (min to max) (t_s)	150°C 200°C 60-180 seconds
$T_{S\ max}$ to T_L -Ramp-up Rate	3°C/second max.
Time maintained above: -Temperature (T_L) -Time (t_L)	217°C 60-150 seconds
Peak Temperature (T_P)	260°C
Time within 5°C of actual Peak Temperature (t_p)	20-40 seconds
Ramp-down Rate	6°C/second max.
Time 25°C to Peak Temperature	8 minutes max.

Dimensions (SOT-23)

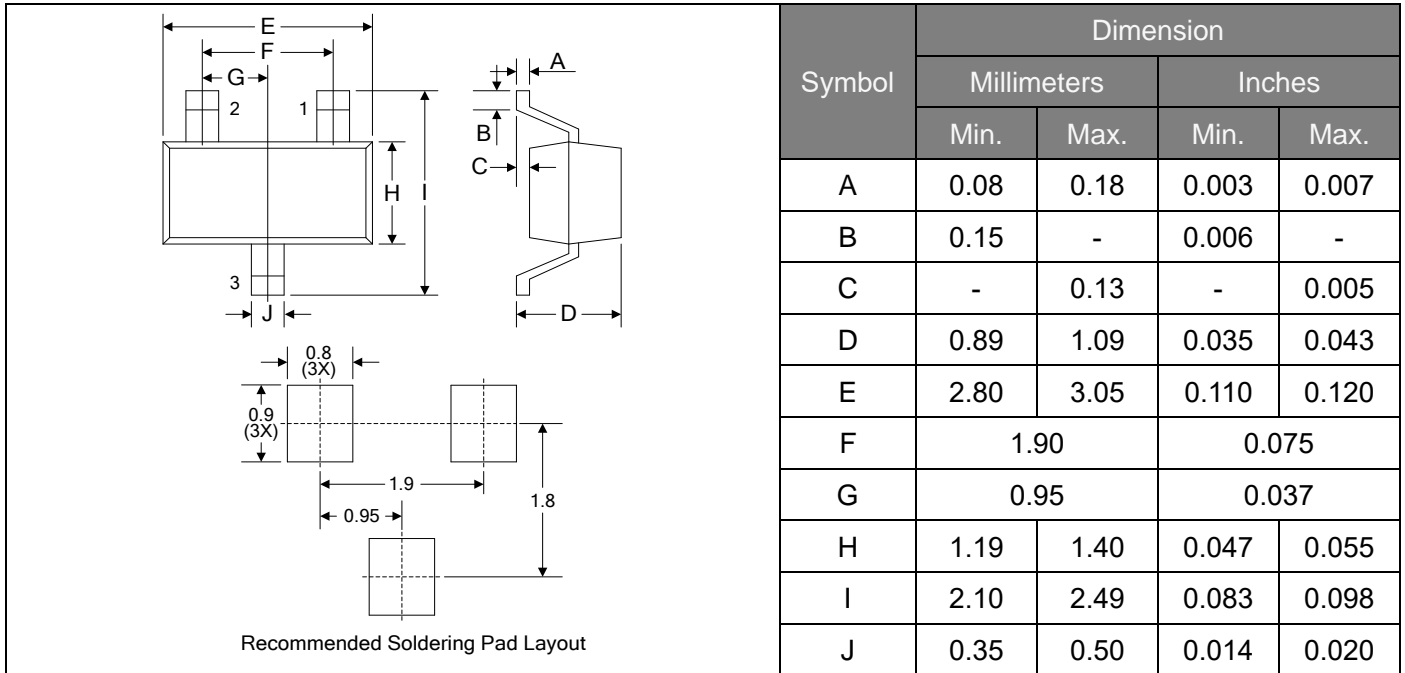

Packaging

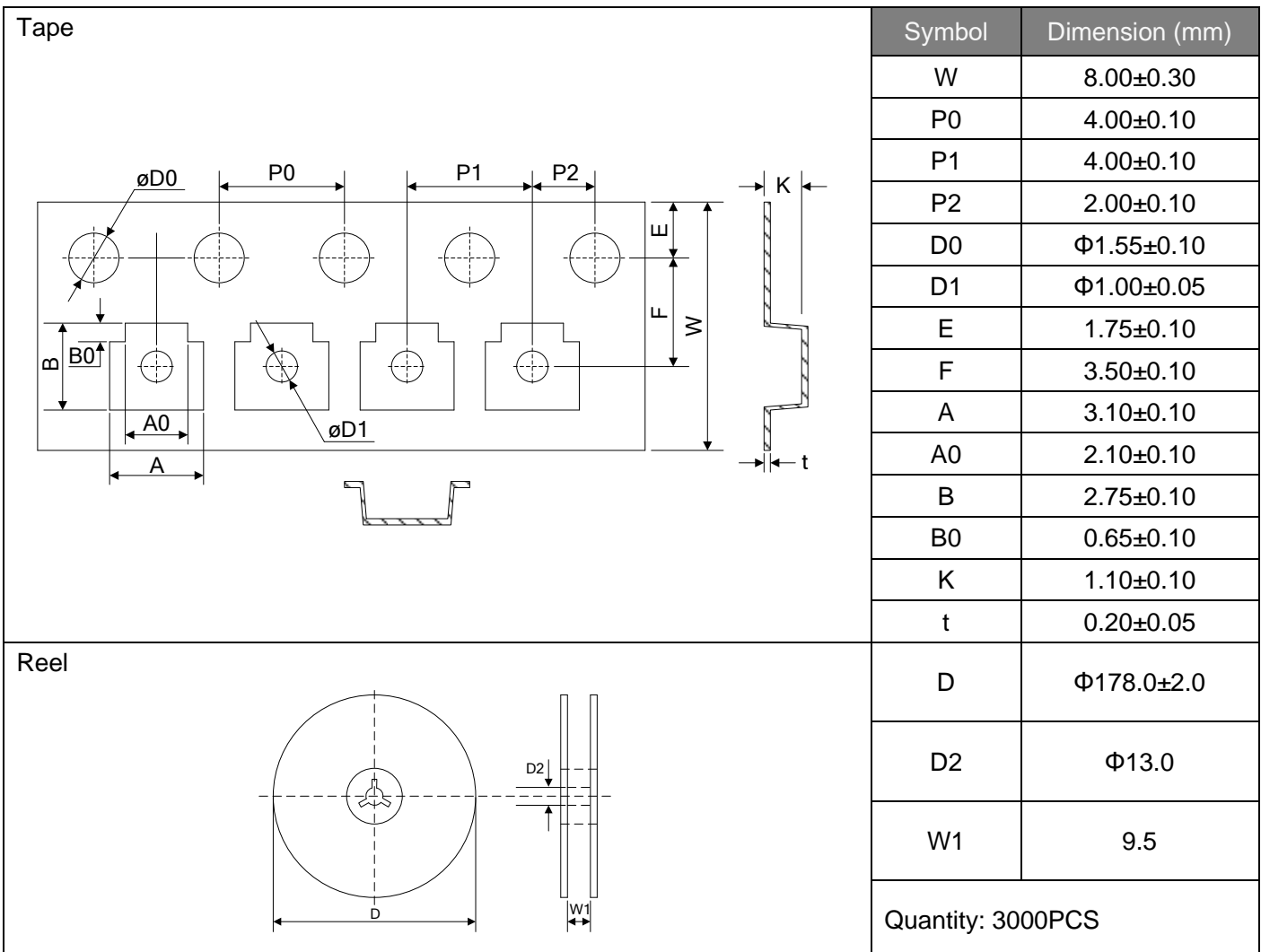

LEGAL DISCLAIMER

YAGEO, its distributors and agents (collectively, "YAGEO"), hereby disclaims any and all liabilities for any errors, inaccuracies or incompleteness contained in any product related information, including but not limited to product specifications, datasheets, pictures and/or graphics. YAGEO may make changes, modifications and/or improvements to product related information at any time and without notice.

YAGEO makes no representation, warranty, and/or guarantee about the fitness of its products for any particular purpose or the continuing production of any of its products. To the maximum extent permitted by law, YAGEO disclaims (i) any and all liability arising out of the application or use of any YAGEO product, (ii) any and all liability, including without limitation special, consequential or incidental damages, and (iii) any and all implied warranties, including warranties of fitness for a particular purpose, non-infringement and merchantability.

YAGEO products are designed for general purpose applications under normal operation and usage conditions. Please contact YAGEO for the applications listed below which require especially high reliability for the prevention of defects which might directly cause damage to the third party's life, body or property: Aerospace equipment (artificial satellite, rocket, etc.), Atomic energy-related equipment, Aviation equipment, Disaster prevention equipment, crime prevention equipment, Electric heating apparatus, burning equipment, Highly public information network equipment, data-processing equipment, Medical devices, Military equipment, Power generation control equipment, Safety equipment, Traffic signal equipment, Transportation equipment and Undersea equipment, or for any other application or use in which the failure of YAGEO products could result in personal injury or death, or serious property damage. Particularly **YAGEO Corporation and its affiliates do not recommend the use of commercial or automotive grade products for high reliability applications or manned space flight.**

Information provided here is intended to indicate product specifications only. YAGEO reserves all the rights for revising this content without further notification, as long as products are unchanged. Any product change will be announced by PCN.