



American Opto Plus LED Corp.

L319EGW-S

3mm Red and Green Bi-Color LED Lamp

DESCRIPTION

- Dual Color LED Lamps
- 3mm diameter
- Lens color : White Diffused
- Compliant with RoHS

FEATURES

- Emitted color : Red/Green
- Technology (Red) : GaAsP/GaP
- Technology (Green): GaP
- Viewing angle : 60°

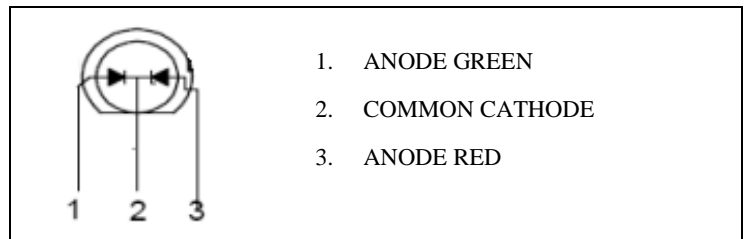
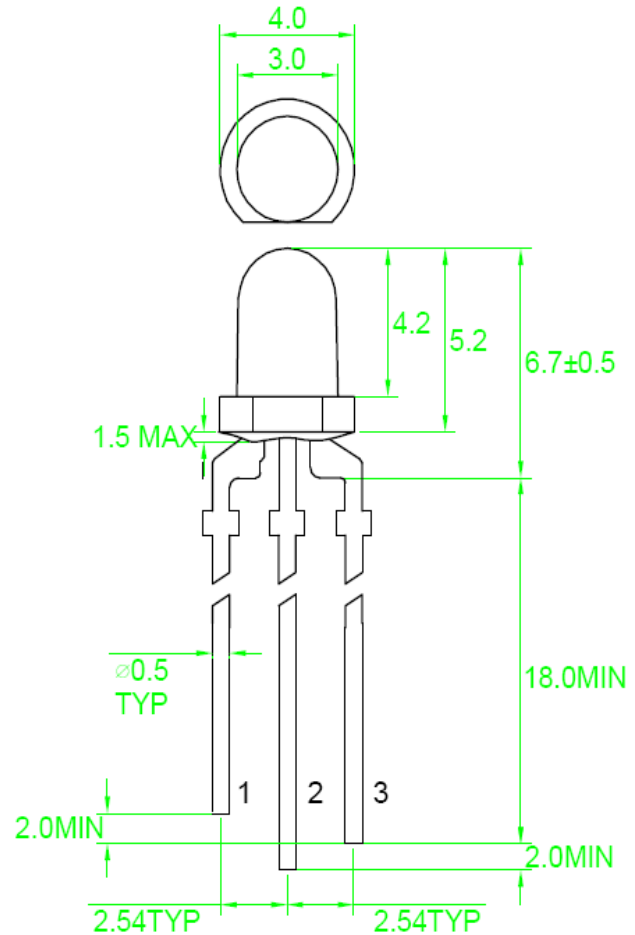

Note: 1. All dimensions are in millimeter tolerance is $\pm 0.25\text{mm}$ unless otherwise noted.

2. Specifications are subject to change without notice.

Part Number	Chip Material		Chip Emitted	Lens Color	Peak Wavelength λ_P (nm)		Luminous Intensity @10mA		Viewing Angle
	R	G			R	G	R	G	
L319EGW-S	GaAsP/ GaP	GaP	Red / Green	White Diffused	635	565	12	15	60°



American Opto Plus LED Corp.

L319EGW-S

3mm Red and Green Bi-Color LED Lamp

ABSOLUTE MAXIMUM RATINGS (Ta = 25°C)

Parameter	Symbol	Max Rating R/G	Unit
Forward Current	I _F	30/30	mA
Power Dissipation	P _D	100/100	mW
Peak Forward Current Duty 1/10 @10KHz	I _{FP}	120/120	mA
Reverse Current @ 5V	I _R	10	μA
Operating Temperature Range	T _{OPR}	-40~+85	°C
Storage Temperature Range	T _{STG}	-40~+100	°C
Soldering Temperature	T _{SOL}	Max 260°C for 5 sec Max	

OPTICAL-ELECTRICAL CHARACTERISTICS (Ta = 25°C)

Parameter	Symbol	Test Condition	Color	Min	Typ	Max	Unit
Luminous Intensity	I _V	I _F = 10mA	R	8.0	12	--	mcd
			G	8.0	15	--	
Forward Voltage	V _F	I _F = 20mA	R	1.7	--	2.6	V
			G	1.7	--	2.6	
Peak Wavelength	λ _P	--	R	--	635	--	nm
			G	--	565	--	
Spectral Halfwidth	Δλ	--	R	--	45	--	nm
			G	--	30	--	
Viewing Angle	2θ _{1/2}	--	--	--	60	--	deg

- Note: 1. The forward voltage data does not include ±0.1V testing tolerance
2. The luminous intensity data does not include ±15% testing tolerance



American Opto Plus LED Corp.

L319EGW-S

3mm Red and Green Bi-Color LED Lamp

TYPICAL OPTICAL-ELECTRICAL CHARACTERISTIC CURVES (RED)

Fig.1 Forward current vs. Forward Voltage

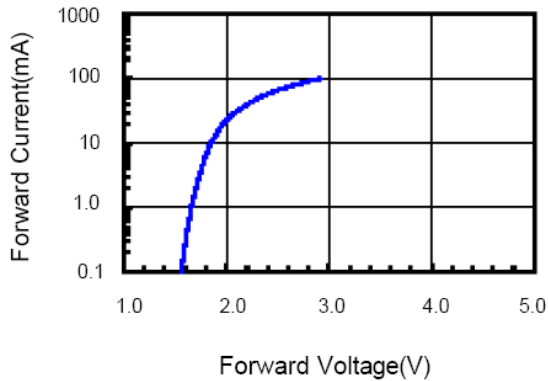

Fig.2 Relative Intensity vs. Forward Current

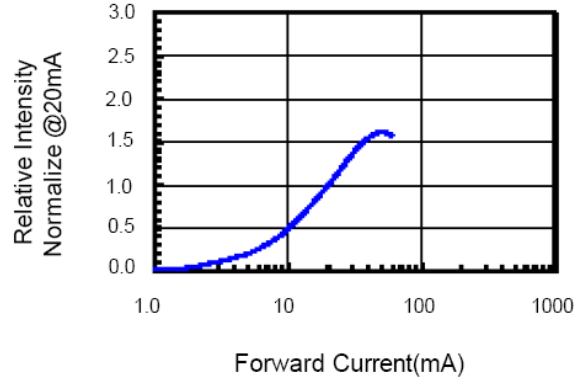

Fig.3 Forward Voltage vs. Temperature

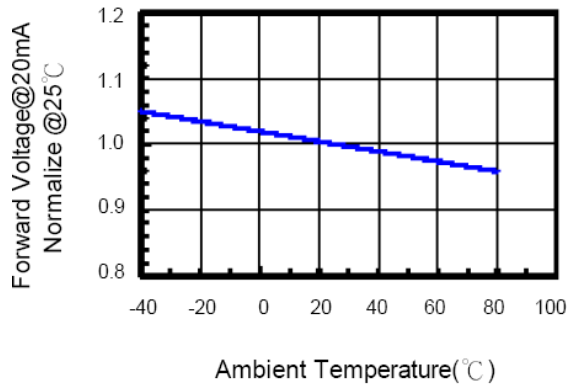

Fig.4 Relative Intensity vs. Temperature

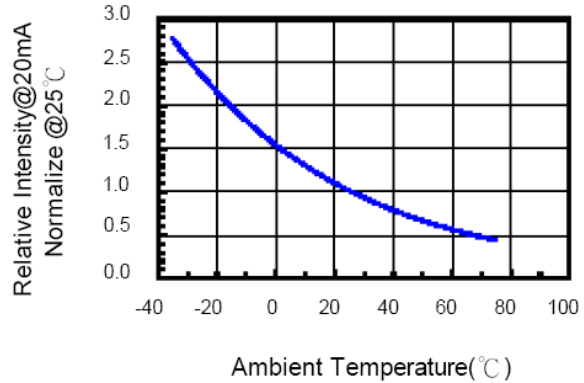
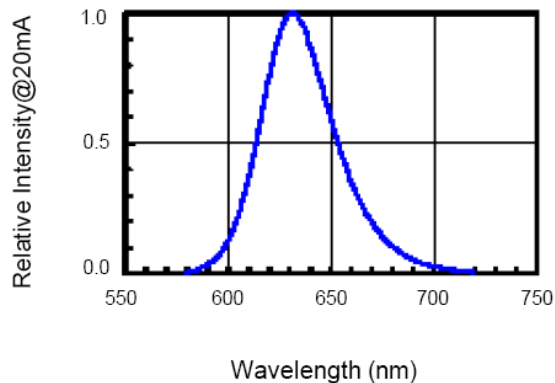

Fig.5 Relative Intensity vs. Wavelength





American Opto Plus LED Corp.

L319EGW-S

3mm Red and Green Bi-Color LED Lamp

TYPICAL OPTICAL-ELECTRICAL CHARACTERISTIC CURVES (GREEN)

Fig.1 Forward current vs. Forward Voltage

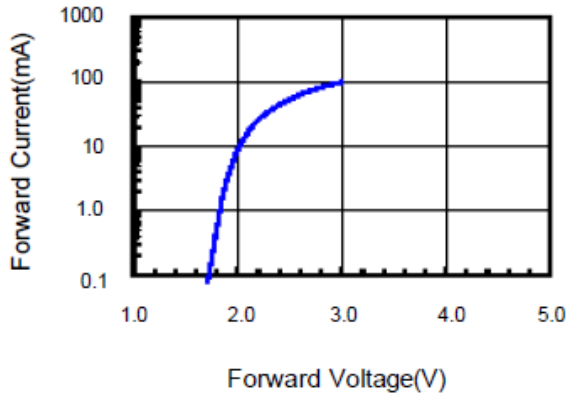

Fig.2 Relative Intensity vs. Forward Current

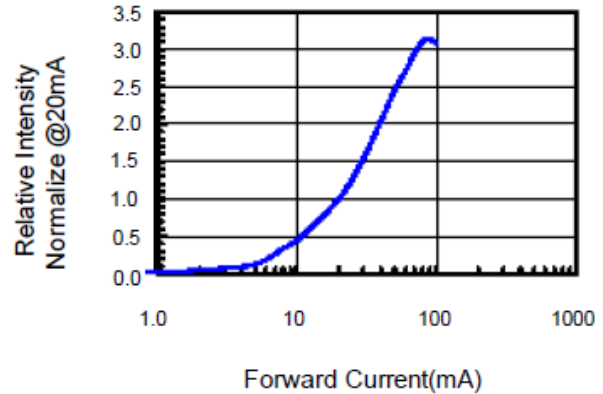

Fig.3 Forward Voltage vs. Temperature

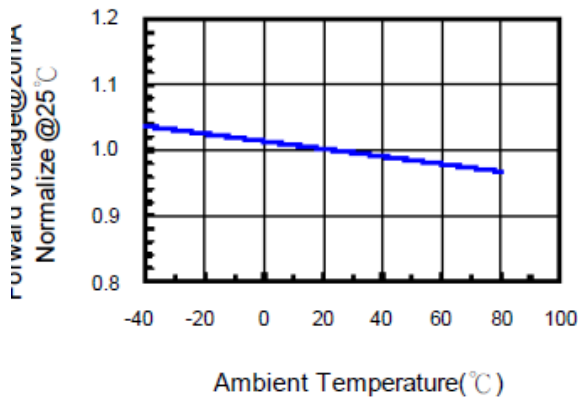

Fig.4 Relative Intensity vs. Temperature

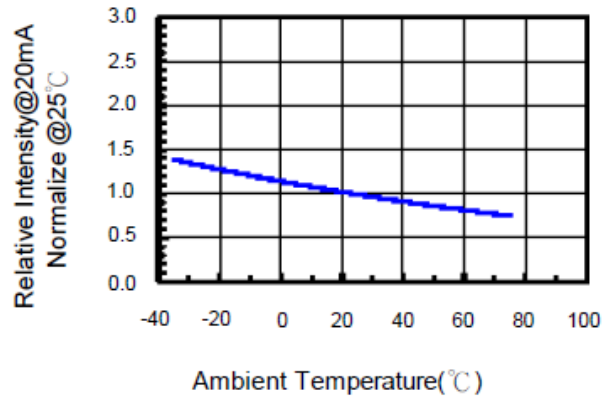
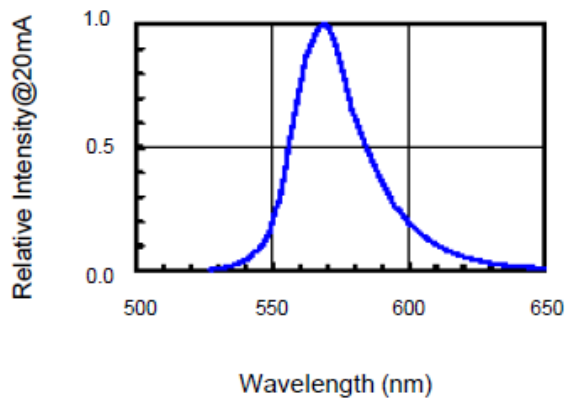

Fig.5 Relative Intensity vs. Wavelength



Directivity Radiation



American Opto Plus LED Corp.

L319EGW-S

3mm Red and Green Bi-Color LED Lamp

RELIABILITY TEST

Test Item	Test Condition	Description	Reference Standard
Operating Life Test	1.Under Room Temperature 2.If=20mA 3.t=1000 hrs (-24hrs, +72hrs)	This test is conducted for the purpose of determining the resistance of a part in electrical and thermal stressed.	MIL-STD-750: 1026 MIL-STD-883: 1005 JIS C 7021: B-1
High Temperature Storage Test	1.Ta=105°C±5°C 2.t=1000 hrs (-24hrs, +72hrs)	The purpose of this is the resistance of the device which is laid under condition of high temperature for hours.	MIL-STD-883:1008 JIS C 7021: B-10
Low Temperature Storage Test	1.Ta=-40°C±5°C 2.t=1000 hrs (-24hrs, +72hrs)	The purpose of this is the resistance of the device which is laid under condition of low temperature for hours.	JIS C 7021: B-12
High Temperature High Humidity Test	1.Ta=65°C±5°C 2.RH=90%~95% 3.t=240hrs±2hrs	The purpose of this test is the resistance of the device under tropical for hours.	MIL-STD-202:103B JIS C 7021: B-11
Thermal Shock Test	1.Ta=105°C±5°C & -40°C±5°C (10min) (10min) 2.total 10 cycles	The purpose of this is the resistance of the device to sudden extreme changes in high and low temperature.	MIL-STD-202: 107D MIL-STD-750: 1051 MIL-STD-883: 1011
Solder Resistance Test	1.T.Sol=260°C±5°C 2.Dwell time= 10±1sec.	This test intended to determine the thermal characteristic resistance of the device to sudden exposures at extreme changes in temperature when soldering the lead wire.	MIL-STD-202: 210A MIL-STD-750: 2031 JIS C 7021: A-1
Solderability Test	1.T.Sol=230°C±5°C 2.Dwell time=5±1sec	This test intended to see soldering well performed or not.	MIL-STD-202: 208D MIL-STD-750: 2026 MIL-STD-883: 2003 JIS C 7021: A-2