



American Opto Plus LED Corp.

L317EGW

3mm Red and Green Bi-Color LED Lamp

DESCRIPTION

- Round Type
- 3mm Diameter
- Lens Color: White Diffused
- With Flange
- Solder leads without standoffs

FEATURES

- Emitted Color: Red/Green
- Standard Luminous Intensity
- Technology: GaAsP/GaP
- Viewing Angle: 70°

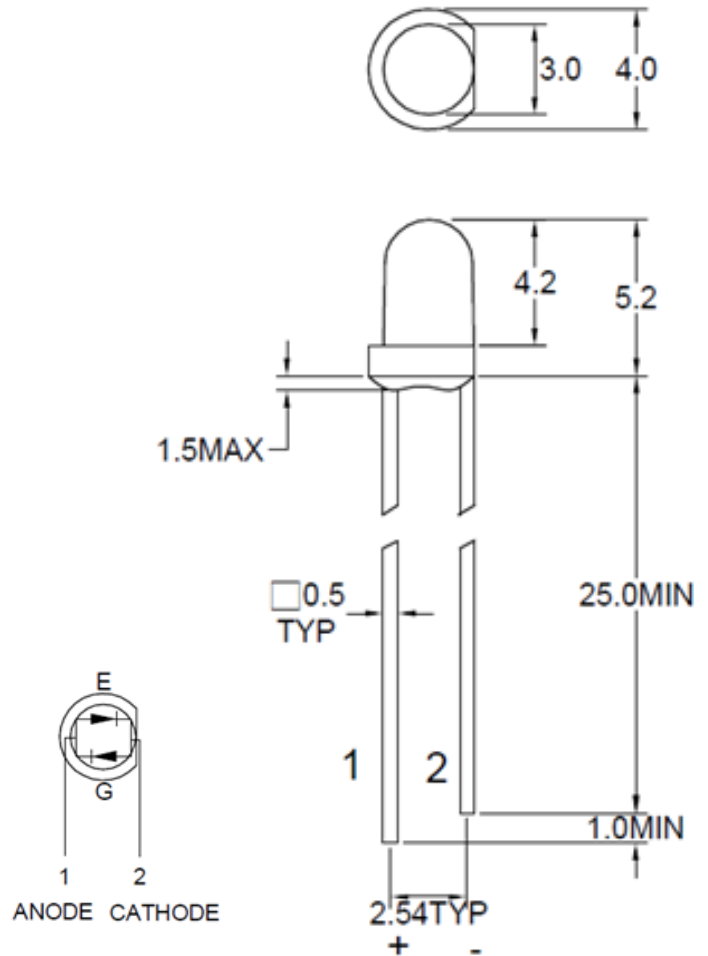

NOTES:

1. All dimensions are in millimeters tolerance is ± 0.25 mm unless otherwise noted
2. Lead Spacing is measured where the lead emerge from the package

Part Number	Material	Lens Color	
		Emitted	Lens
L317EGW	GaAsP/GaP	Red/Green	White Diffused



American Opto Plus LED Corp.

L317EGW

3mm Red and Green Bi-Color LED Lamp

ABSOLUTE MAXIMUM RATINGS

(Ta=25°C)

Parameter	Symbol	Ratings	Unit
Peak Forward Current Duty 1/10@10KHz	I_{FP}	Red: 120 Green: 120	mA
Forward Current	I_F	30	V
Power Dissipation	P_d	Red: 100 Green: 100	mW
Operating temperature range	T_{opr}	-40~+85	°C
Storage temperature range	T_{stg}	-40~+100	°C

OPTICAL-ELECTRICAL CHARACTERISTICS

(Ta=25°C)

Parameter	Symbol	Test Condition	Color	Min	Typ	Max	Unit
Luminous Intensity	I_v	IF=10mA	R	4.5	8.0	--	mcd
			G	3.0	5.0	--	
Forward Voltage	V_F	IF=20mA	R	1.7	--	2.6	V
			G	1.7	--	2.6	
Reverse Current	I_R	$V_R=5V$	R	--	--	10	μA
			G	--	--	10	
Peak Wavelength	λ_P	IF=20mA	R	--	635	--	nm
			G	--	565	--	
Spectrum Halfwidth	$\Delta\lambda$	IF=20mA	R	--	45	--	nm
			G	--	30	--	
Viewing Angle	2 θ 1/2	IF=20mA		--	70	--	deg

NOTES:

1. Forward voltage data did not include $\pm 0.1V$ testing tolerance.
2. Luminous intensity data did not include $\pm 15\%$ testing tolerance.



American Opto Plus LED Corp.

L317EGW

3mm Red and Green Bi-Color LED Lamp

TYPICAL ELECTRICAL-OPTICAL CHARACTERISTIC CURVES (RED)

Fig.1 Forward current vs. Forward Voltage

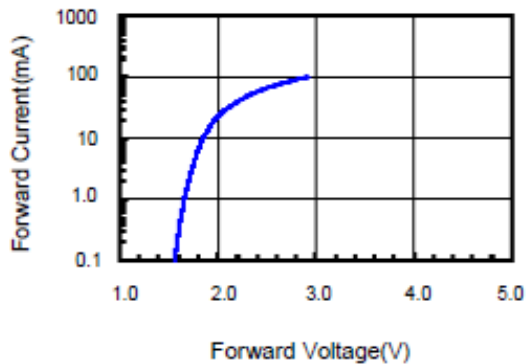

Fig.2 Relative Intensity vs. Forward Current

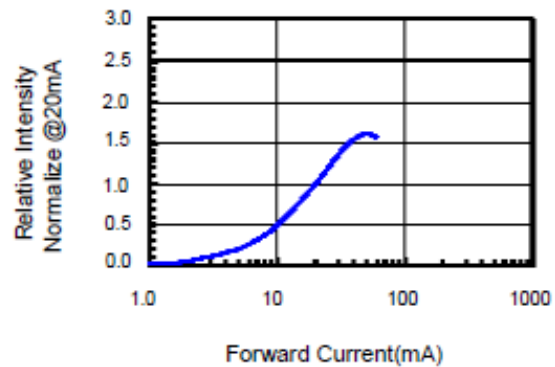

Fig.3 Forward Voltage vs. Temperature

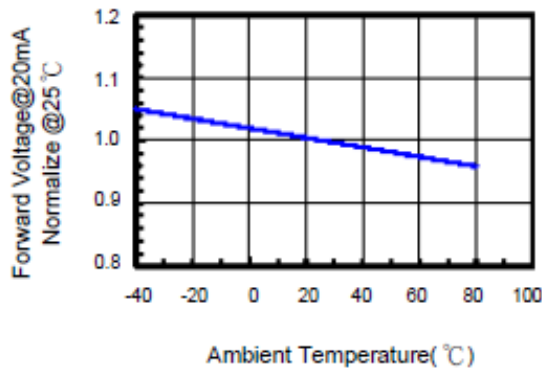

Fig.4 Relative Intensity vs. Temperature

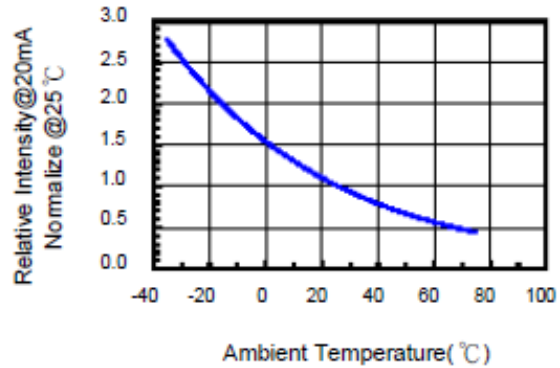
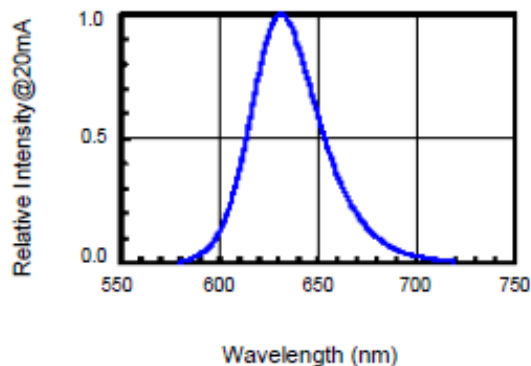
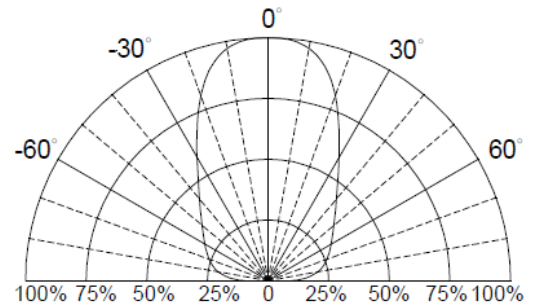

Fig.5 Relative Intensity vs. Wavelength



Directivity Radiation





American Opto Plus LED Corp. L317EGW

3mm Red and Green Bi-Color LED Lamp

TYPICAL ELECTRICAL-OPTICAL CHARACTERISTIC CURVES (GREEN)

Fig.1 Forward current vs. Forward Voltage

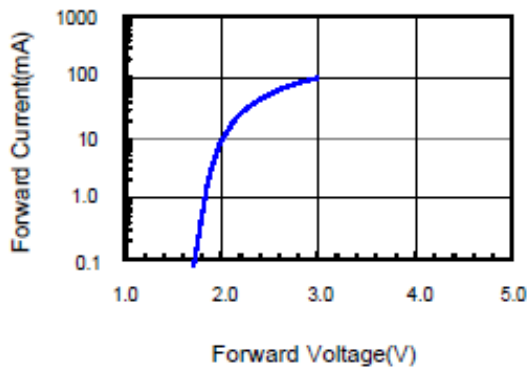

Fig.2 Relative Intensity vs. Forward Current

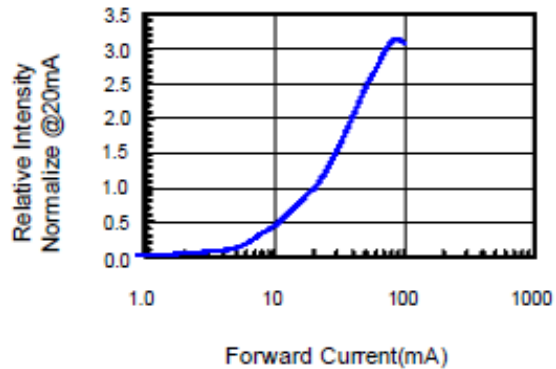

Fig.3 Forward Voltage vs. Temperature

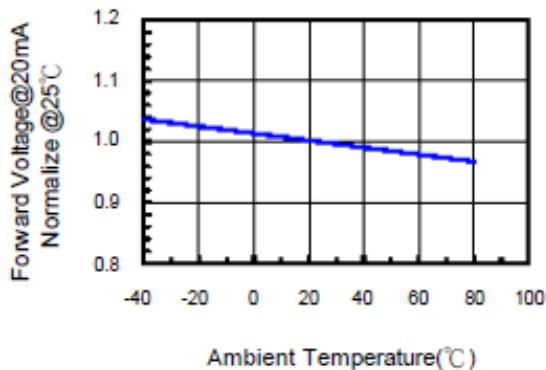

Fig.4 Relative Intensity vs. Temperature

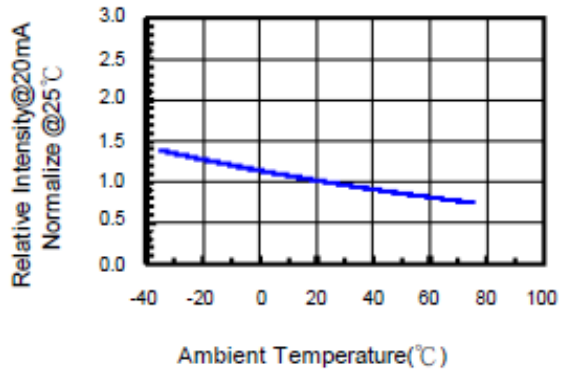
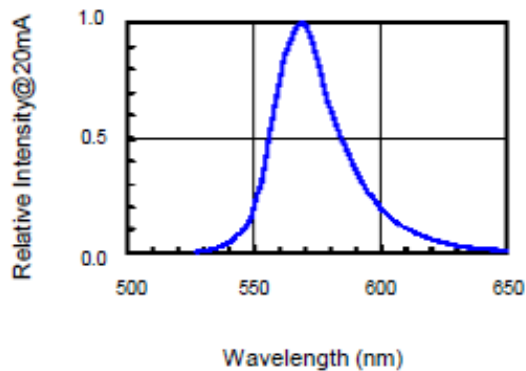
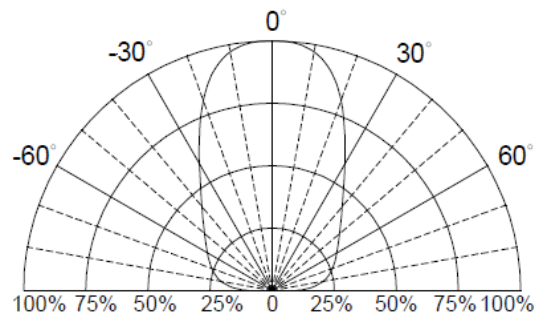

Fig.5 Relative Intensity vs. Wavelength



Directivity Radiation





American Opto Plus LED Corp.

L317EGW

3mm Red and Green Bi-Color LED Lamp

SOLDERING CONDITION (Pb-Free)

1. Iron:
Soldering Iron: 30W Max
Temperature 350 °C Max
Soldering Time: 3 Seconds Max (one time)
Distance: 2mm Min (from solder joint to body)
2. Wave soldering Profile:
Dip Soldering
Preheat: 120 °C Max
Preheat time: 60 seconds Max
Ramp-Up
2 °C/sec (Max)
Ramp-Down: -5 °C/sec (max)
Solder Bath: 260 °C Max
Dipping Time: 3 seconds max
Distance: 2mm Min (from solder joint to body)

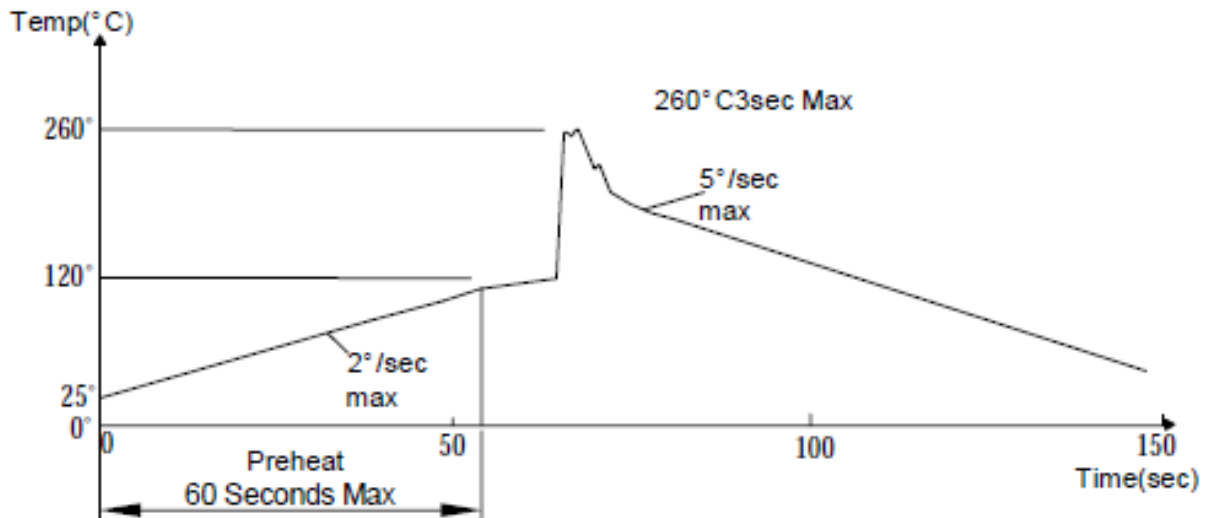



American Opto Plus LED Corp.

L317EGW

3mm Red and Green Bi-Color LED Lamp

RELIABILITY TEST

Test Item	Test Condition	Description	Reference Standard
Operating Life Test	1.Under Room Temperature 2.If=20mA 3.t=1000 hrs (-24hrs, +72hrs)	This test is conducted for the purpose of determining the resistance of a part in electrical and thermal stressed.	MIL-STD-750: 1026 MIL-STD-883: 1005 JIS C 7021: B-1
High Temperature Storage Test	1.Ta=105°C±5°C 2.t=1000 hrs (-24hrs, +72hrs)	The purpose of this is the resistance of the device which is laid under condition of high temperature for hours.	MIL-STD-883:1008 JIS C 7021: B-10
Low Temperature Storage Test	1.Ta=-40°C±5°C 2.t=1000 hrs (-24hrs, +72hrs)	The purpose of this is the resistance of the device which is laid under condition of low temperature for hours.	JIS C 7021: B-12
High Temperature High Humidity Test	1.Ta=85°C±5°C 2.RH=90%~95% 3.t=240hrs±2hrs	The purpose of this test is the resistance of the device under tropical for hours.	MIL-STD-202:103B JIS C 7021: B-11
Thermal Shock Test	1.Ta=105°C±5°C & -40°C±5°C (10min) (10min) 2.total 10 cycles	The purpose of this is the resistance of the device to sudden extreme changes in high and low temperature.	MIL-STD-202: 107D MIL-STD-750: 1051 MIL-STD-883: 1011
Solder Resistance Test	1.T.Sol=260°C±5°C 2.Dwell time= 10±1sec.	This test intended to determine the thermal characteristic resistance of the device to sudden exposures at extreme changes in temperature when soldering the lead wire.	MIL-STD-202: 210A MIL-STD-750: 2031 JIS C 7021: A-1
Solderability Test	1.T.Sol=230°C±5°C 2.Dwell time=5±1sec	This test intended to see soldering well performed or not.	MIL-STD-202: 208D MIL-STD-750: 2026 MIL-STD-883: 2003 JIS C 7021: A-2