

OSRAM KW4 HPL631.TK

Datasheet

Published by **ams-OSRAM AG**

Tobelbader Strasse 30, 8141 Premstaetten, Austria

Phone +43 3136 500-0

ams-osram.com

© All rights reserved



OSLON® Black Flat X

KW4 HPL631.TK

The OSLON Black Flat X product family offers LED devices with the highest efficiency in the ams OSRAM portfolio. This feature makes it the perfect light source for standard forward lighting applications with a high focus on system cost. The SMT device is very stable, durable and can be used with standard processes. The pad geometry of the widely used OSLON Black Flat product platform was further optimized to allow for excellent thermal conditions, while the already known, outstanding contrast of the package concept is kept on the familiar level.



Applications

- Static Forward Lighting

Features

- Package: SMD epoxy package
- Chip technology: UX:3
- Typ. Radiation: 120° (Lambertian emitter)
- Color: $C_x = 0.321$, $C_y = 0.339$ acc. to CIE 1931 (● ultra white)
- Corrosion Robustness Class: 3B
- Qualifications: AEC-Q102 Qualified
- ESD: 8 kV acc. to ANSI/ESDA/JEDEC JS-001 (HBM, Class 3B)
- Color over angle: Better than passus 3.7.2.1 of supplement proposal 7 to ECE reg. 128

Ordering Information

Type	Luminous Flux ¹⁾ $I_F = 1000 \text{ mA}$ Φ_V	Ordering Code
KW4 HPL631.TK-BCBH-4L05M0-AGAE	1640 ... 2040 lm	Q65113A1248
KW4 HPL631.TK-BCBJ-4L07M0-AGAE	1640 ... 2115 lm	Q65113A4586
KW4 HPL631.TK-BDBJ-6L07M0-AGAE	1700 ... 2115 lm	Q65113A1296

During ramp up a smaller amount of pcs are taped on one reel.

Maximum Ratings

Parameter	Symbol		Values
Operating Temperature ²⁾	T_{op}	min.	-40 °C
		max.	135 °C
Storage Temperature	T_{stg}	min.	-40 °C
		max.	135 °C
Junction Temperature	T_j	max.	150 °C
Junction Temperature for short time applications*	T_j	max.	175 °C
Forward current $T_s = 25\text{ °C}$	I_F	min.	50 mA
		max.	1500 mA
Forward current pulsed $D = 0.005$; $T_s = 25\text{ °C}$	$I_{F\ pulse}$	max.	1500 mA
Surge current $t \leq 50\ \mu\text{s}$; $D = 0.025$; $T_j = 150\text{ °C}$	I_{FS}	max.	2000 mA
Surge current $t \leq 10\ \mu\text{s}$; $D = 0.005$; $T_s = 25\text{ °C}$	I_{FS}	max.	2500 mA
ESD withstand voltage acc. to ANSI/ESDA/JEDEC JS-001 (HBM, Class 3B)	V_{ESD}		8 kV
Reverse current ³⁾	I_R	max.	200 mA

* The median lifetime (L70/B50) for $T_j = 175\text{ °C}$ is 100h.

Characteristics

$I_F = 1000 \text{ mA}$; $T_S = 25 \text{ °C}$

Parameter	Symbol		Values
Chromaticity Coordinate ⁴⁾	C_x	typ.	0.321
	C_y	typ.	0.339
Viewing angle at 50% I_V	2ϕ	typ.	120 °
Radiating surface	A_{color}	typ.	4,4 mm ²
Forward Voltage ⁵⁾ $I_F = 1000 \text{ mA}$	V_F	min.	11.20 V
		typ.	12.81 V
		max.	13.50 V
Reverse voltage (ESD device)	$V_{R\text{ESD}}$	min.	45 V
Reverse voltage ³⁾ $I_R = 20 \text{ mA}$	V_R	max.	1.2 V
Real thermal resistance junction/solderpoint ⁴⁾	$R_{\text{thJS real}}$	typ.	1.02 K / W
		max.	1.23 K / W
Electrical thermal resistance junction/solderpoint ⁶⁾ with efficiency $\eta_e = 39 \%$	$R_{\text{thJS elec.}}$	typ.	0.62 K / W
		max.	0.75 K / W

Brightness Groups

Group	Luminous Flux ¹⁾ $I_F = 1000 \text{ mA}$ min. Φ_V	Luminous Flux ¹⁾ $I_F = 1000 \text{ mA}$ max. Φ_V
BC	1640 lm	1700 lm
BD	1700 lm	1760 lm
BE	1760 lm	1825 lm
BF	1825 lm	1895 lm
BG	1895 lm	1965 lm
BH	1965 lm	2040 lm
BJ	2040 lm	2115 lm

Forward Voltage Groups

Group	Forward Voltage ⁵⁾ $I_F = 1000 \text{ mA}$ min. V_F	Forward Voltage ⁵⁾ $I_F = 1000 \text{ mA}$ max. V_F
AG	11.20 V	12.00 V
SG	12.00 V	12.80 V
AE	12.80 V	13.50 V

Chromaticity Coordinate Groups

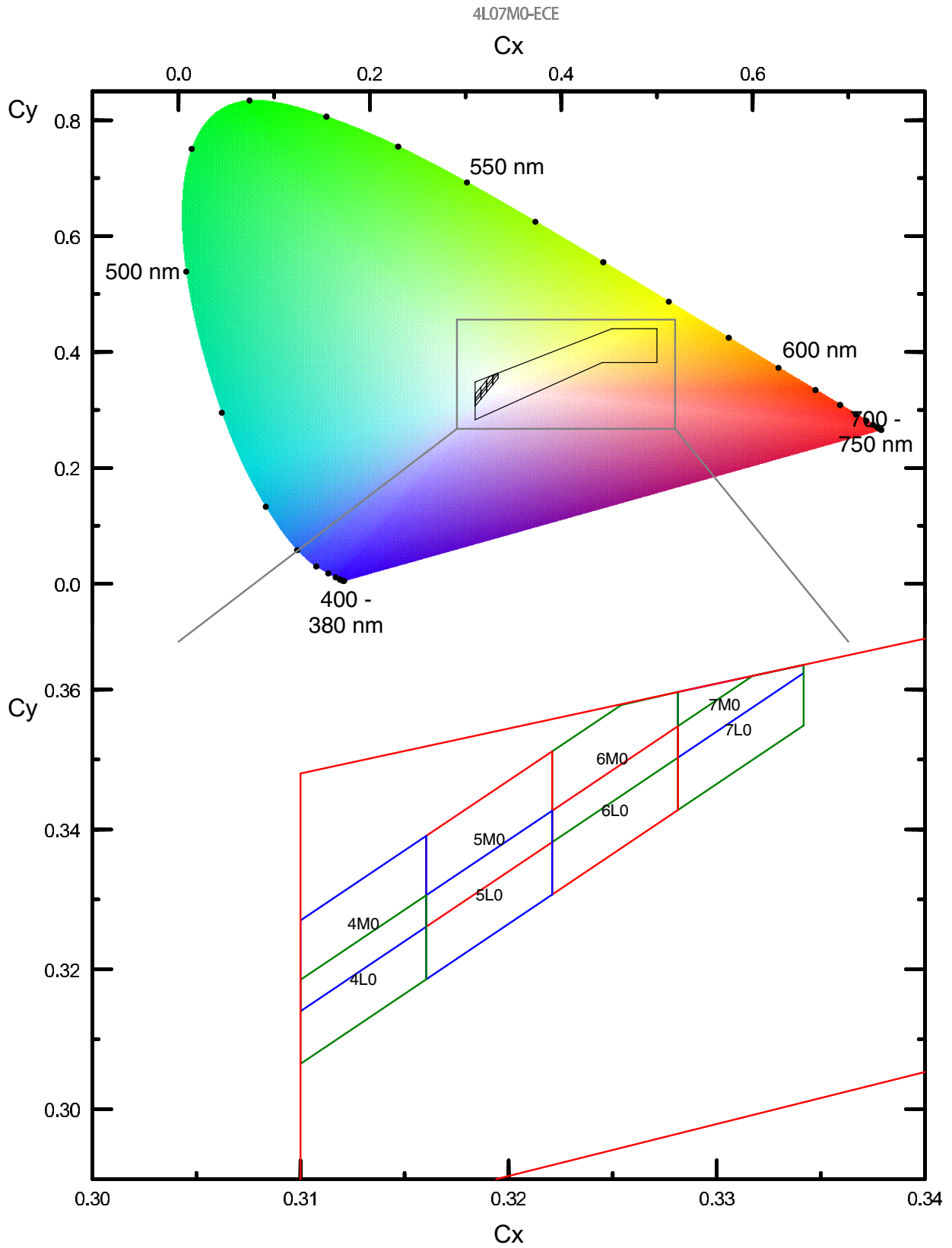

Chromaticity Coordinate Groups ⁴⁾

Group	Cx	Cy	Group	Cx	Cy	Group	Cx	Cy
4L0	0.3100	0.3065	5M0	0.3160	0.3261	7L0	0.3281	0.3428
	0.3100	0.3185		0.3160	0.3391		0.3281	0.3548
	0.3160	0.3306		0.3221	0.3512		0.3317	0.3620
	0.3160	0.3186		0.3221	0.3382		0.3342	0.3635
4M0	0.3100	0.3140	6L0	0.3221	0.3307	7M0	0.3281	0.3503
	0.3100	0.3270		0.3221	0.3427		0.3281	0.3597
	0.3160	0.3391		0.3281	0.3548		0.3342	0.3635
	0.3160	0.3261		0.3281	0.3428		0.3342	0.3624
5L0	0.3160	0.3186	6M0	0.3221	0.3382			
	0.3160	0.3306		0.3221	0.3512			
	0.3221	0.3427		0.3254	0.3578			
	0.3221	0.3307		0.3281	0.3597			
				0.3281	0.3503			

Group Name on Label

Example: BC-4L0-AE

Brightness

Color Chromaticity

Forward Voltage

BC

4L0

AE

Relative Spectral Emission ⁷⁾

$$\Phi_{rel} = f(\lambda); I_F = 1000 \text{ mA}; T_J = 25 \text{ }^\circ\text{C}$$

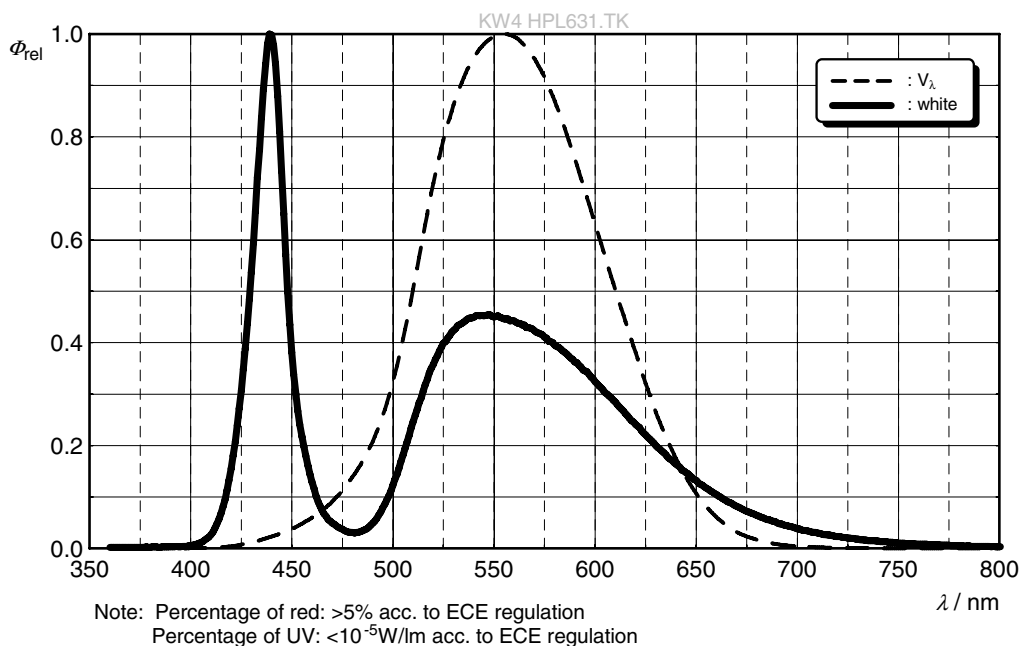

Radiation Characteristics ⁷⁾

$$I_{rel} = f(\phi); T_J = 25 \text{ }^\circ\text{C}$$

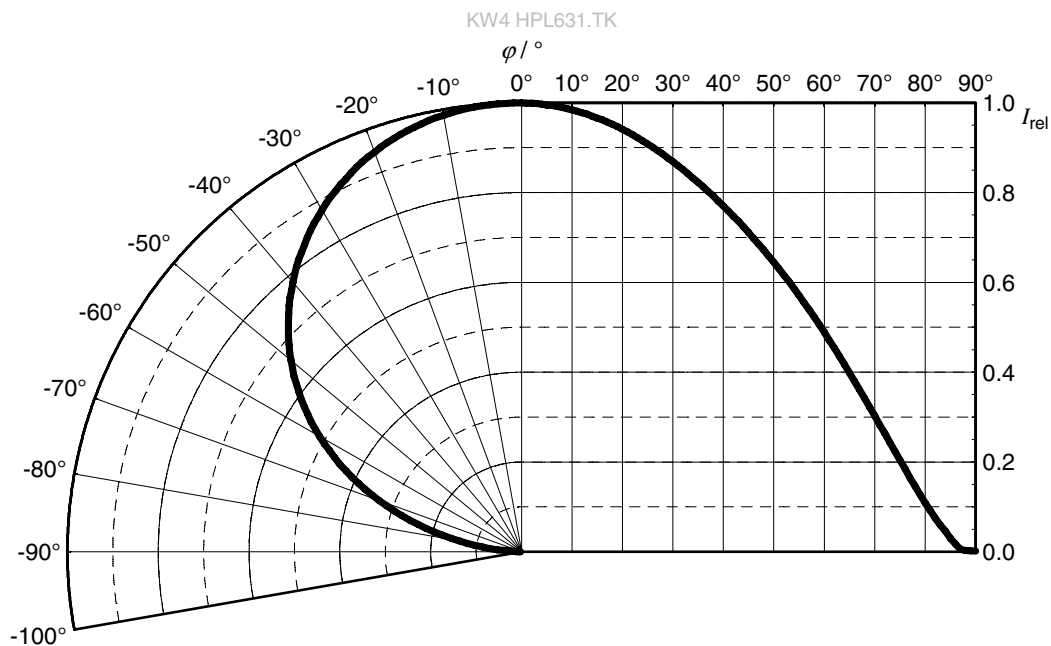

Forward current ⁷⁾

$$I_F = f(V_F); T_J = 25\text{ }^\circ\text{C}$$

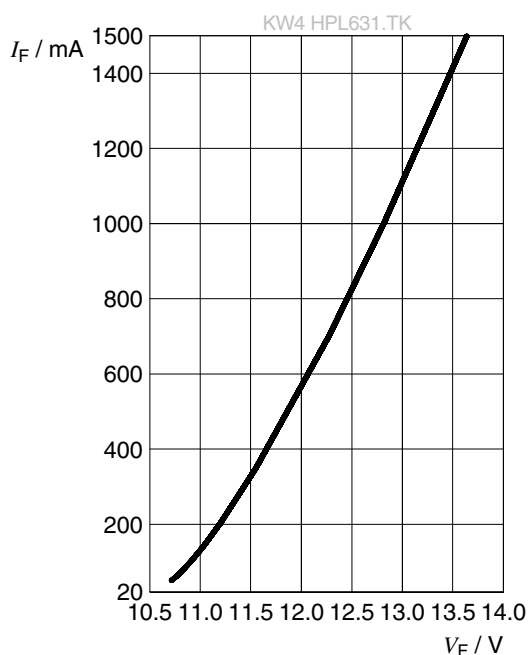

Relative Luminous Flux ^{7), 8)}

$$\Phi_V / \Phi_V(1000\text{ mA}) = f(I_F); T_J = 25\text{ }^\circ\text{C}$$

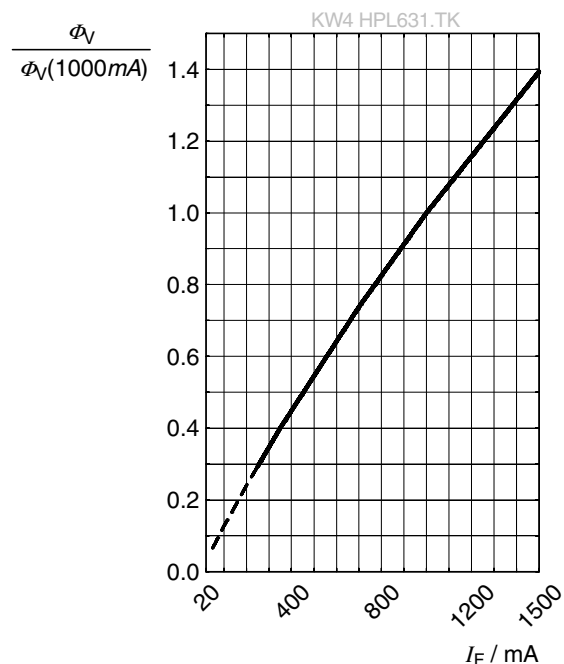

Chromaticity Coordinate Shift ⁷⁾

$$C_x, C_y = f(I_F); T_J = 25\text{ }^\circ\text{C}$$

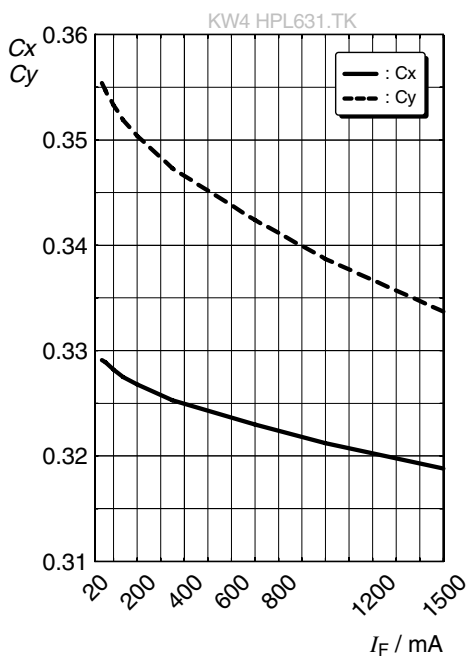

Forward Voltage ⁷⁾

$$\Delta V_F = V_F - V_F(25\text{ }^\circ\text{C}) = f(T_j); I_F = 1000\text{ mA}$$

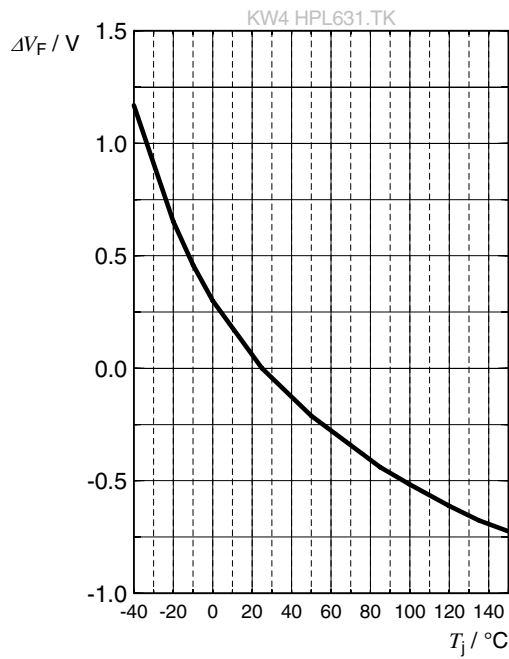

Relative Luminous Flux ⁷⁾

$$\Phi_V / \Phi_V(25\text{ }^\circ\text{C}) = f(T_j); I_F = 1000\text{ mA}$$

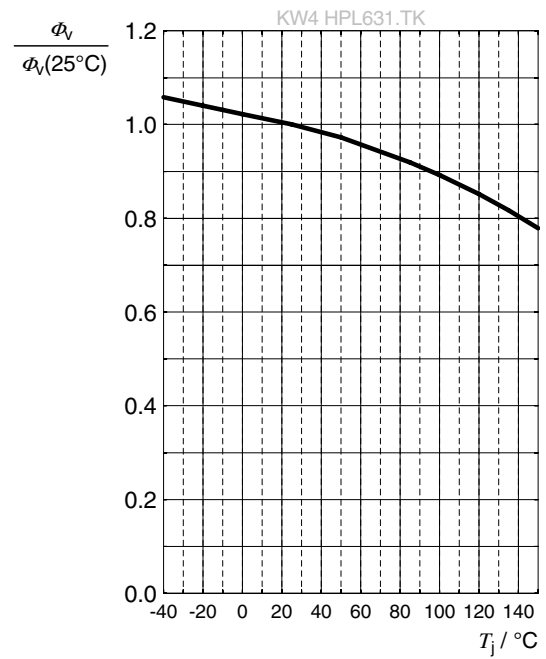

Chromaticity Coordinate Shift ⁷⁾

$$C_x, C_y = f(T_j); I_F = 1000\text{ mA}$$

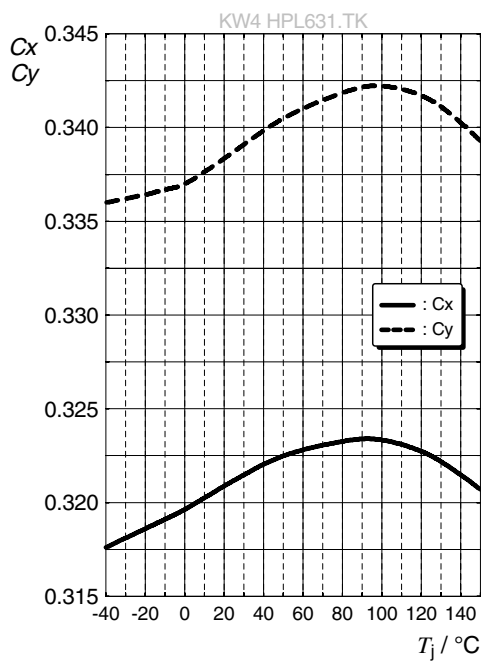

Max. Permissible Forward Current

$$I_F = f(T)$$

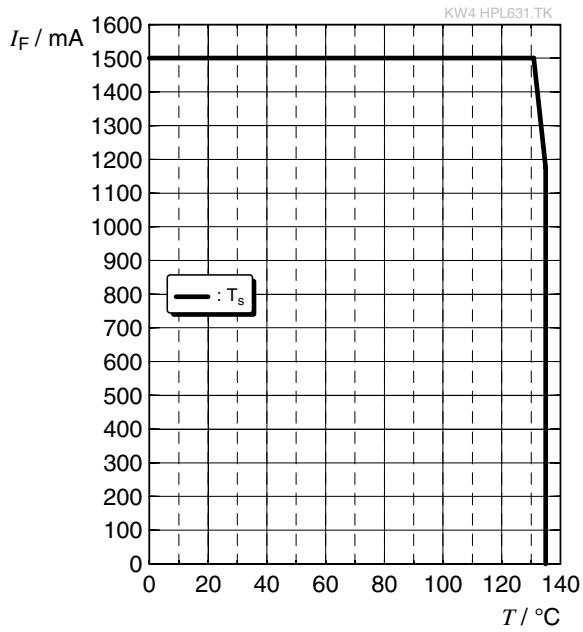

Dimensional Drawing ⁹⁾

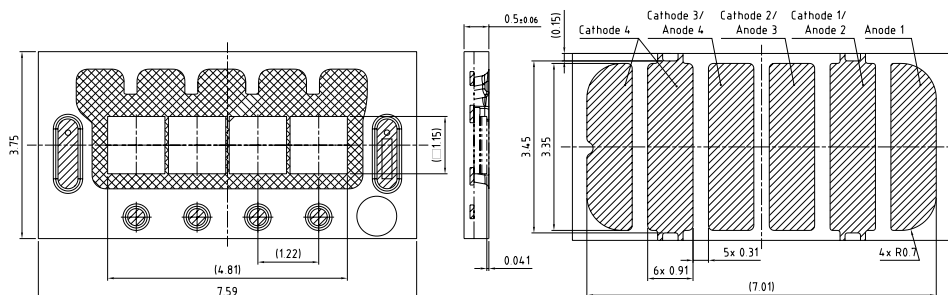

C67062-A0349-A1-03

Further Information:

Approximate Weight: 40.0 mg

Corrosion test: Class: 3B
Test condition: 40°C / 90 % RH / 15 ppm H₂S / 14 days (stricter than IEC 60068-2-43)

ESD advice: The device is protected by ESD device which is connected in parallel to the Chip.

Reflow Soldering Profile

Product complies to MSL Level 2 acc. to JEDEC J-STD-020E

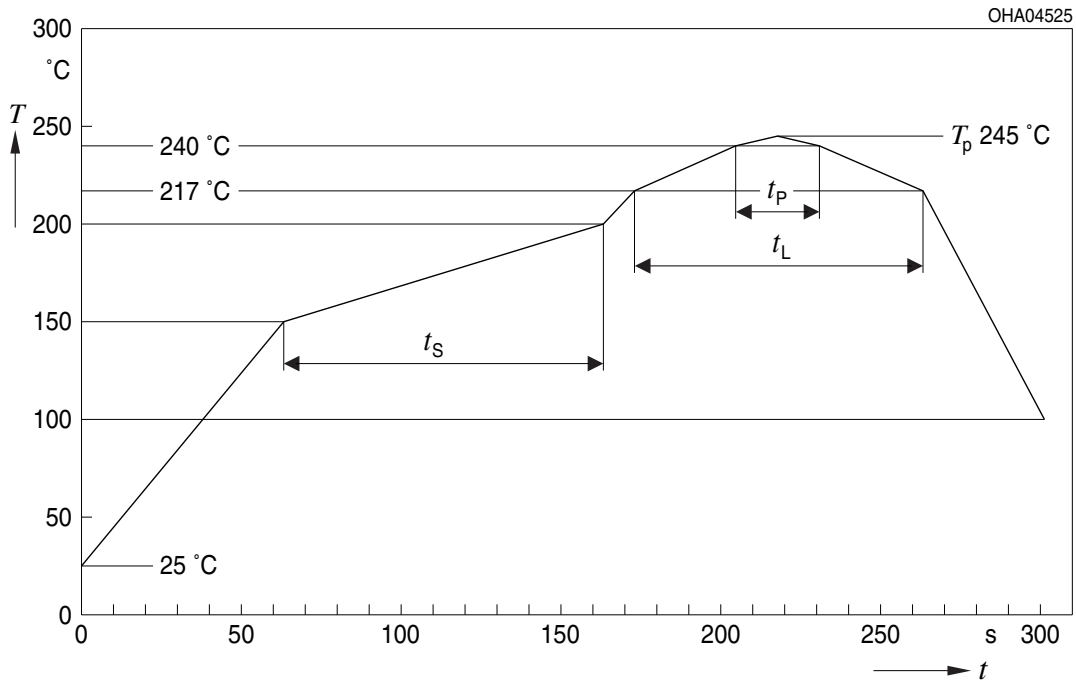

Profile Feature	Symbol	Pb-Free (SnAgCu) Assembly			Unit
		Minimum	Recommendation	Maximum	
Ramp-up rate to preheat ^{*)} 25 °C to 150 °C			2	3	K/s
Time t_s T_{Smin} to T_{Smax}	t_s	60	100	120	s
Ramp-up rate to peak ^{*)} T_{Smax} to T_p			2	3	K/s
Liquidus temperature	T_L		217		°C
Time above liquidus temperature	t_L		80	100	s
Peak temperature	T_p		245	260	°C
Time within 5 °C of the specified peak temperature $T_p - 5$ K	t_p	10	20	30	s
Ramp-down rate* T_p to 100 °C			3	6	K/s
Time 25 °C to T_p				480	s

All temperatures refer to the center of the package, measured on the top of the component
^{*)} slope calculation DT/Dt : Dt max. 5 s; fulfillment for the whole T-range

Taping ⁹⁾

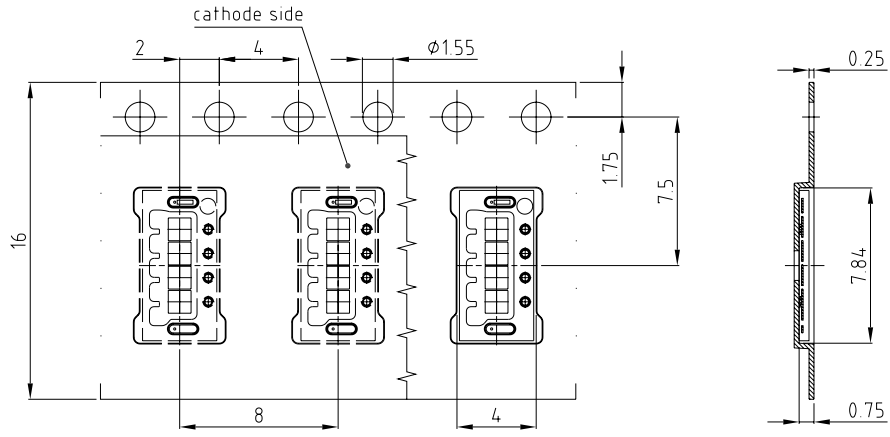

C67062-A0349-B1-03

Tape and Reel ¹⁰⁾

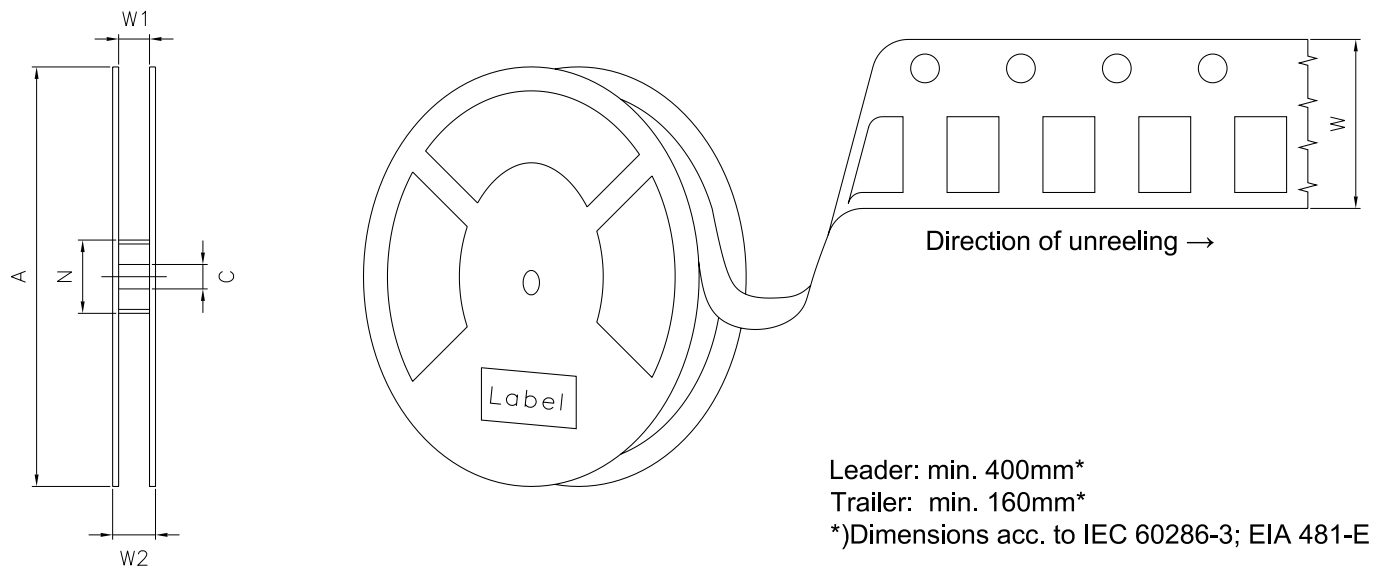

Reel Dimensions

A	W	N _{min}	W ₁	W _{2max}	Pieces per PU
180 mm	12 + 0.3 / - 0.1 mm	60 mm	12.4 + 2 mm	18.4 mm	2000

Barcode-Product-Label (BPL)



OSRAM Opto Semiconductors LX XXXX BIN1: XX-XX-X-XXX-X

RoHS Compliant

(6P) BATCH NO: 1234567890 ML Temp ST
X XXX °C X

(1T) LOT NO: 1234567890 (9D) D/C: 1234

Pack: RXX
DEMY XXX
X_X123_1234.1234 X

(X) PROD NO: 123456789(Q)QTY: 9999 (G) GROUP: XX-XX-X-X

OHA04563

Dry Packing Process and Materials ⁹⁾

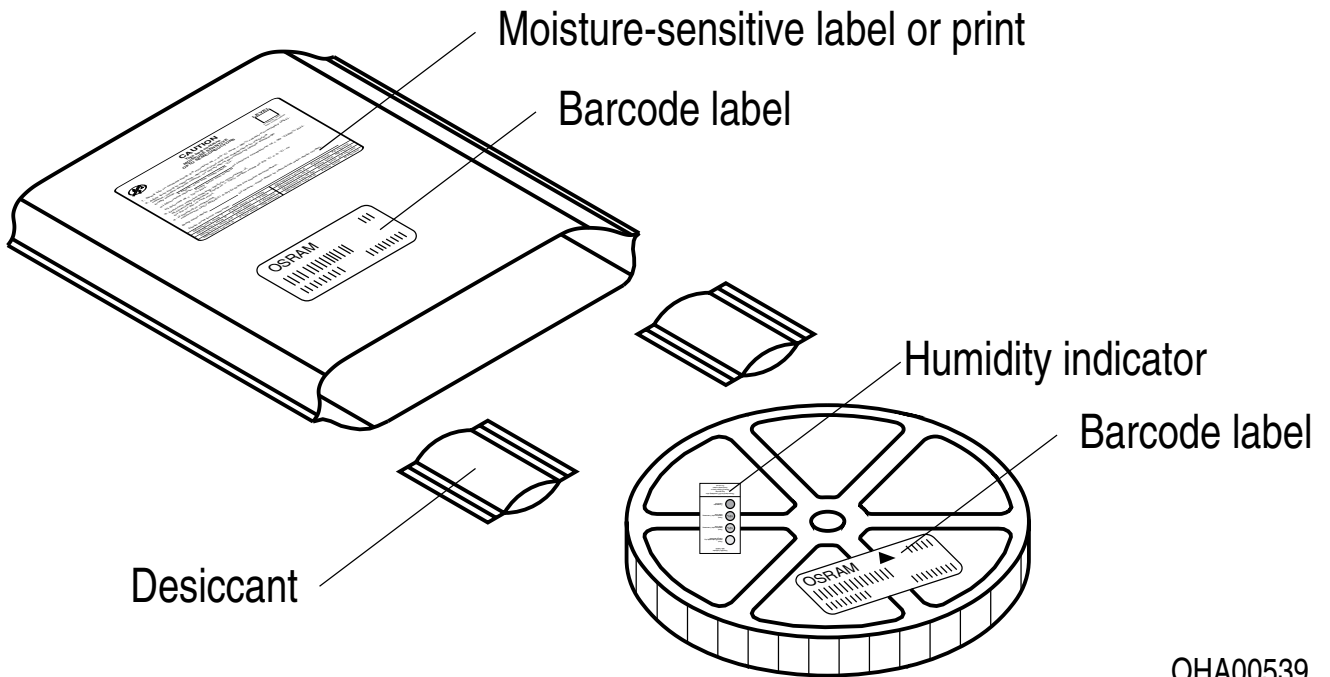

OHA00539

Moisture-sensitive product is packed in a dry bag containing desiccant and a humidity card according JEDEC-STD-033.

Notes

The evaluation of eye safety occurs according to the standard IEC 62471:2006 (photo biological safety of lamps and lamp systems). Within the risk grouping system of this IEC standard, the device specified in this data sheet fall into the class **moderate risk (exposure time 0.25 s)**. Under real circumstances (for exposure time, conditions of the eye pupils, observation distance), it is assumed that no endangerment to the eye exists from these devices. As a matter of principle, however, it should be mentioned that intense light sources have a high secondary exposure potential due to their blinding effect. When looking at bright light sources (e.g. headlights), temporary reduction in visual acuity and afterimages can occur, leading to irritation, annoyance, visual impairment, and even accidents, depending on the situation.

Subcomponents of this device contain, in addition to other substances, metal filled materials including silver. Metal filled materials can be affected by environments that contain traces of aggressive substances. Therefore, we recommend that customers minimize device exposure to aggressive substances during storage, production, and use. Devices that showed visible discoloration when tested using the described tests above did show no performance deviations within failure limits during the stated test duration. Respective failure limits are described in the IEC60810.

For further application related information please visit www.osram-os.com/appnotes

Disclaimer

Attention please!

The information describes the type of component and shall not be considered as assured characteristics. Terms of delivery and rights to change design reserved. Due to technical requirements components may contain dangerous substances.

For information on the types in question please contact our Sales Organization.

If printed or downloaded, please find the latest version on our website.

Packing

Please use the recycling operators known to you. We can also help you – get in touch with your nearest sales office. By agreement we will take packing material back, if it is sorted. You must bear the costs of transport. For packing material that is returned to us unsorted or which we are not obliged to accept, we shall have to invoice you for any costs incurred.

Product and functional safety devices/applications or medical devices/applications

Our components are not developed, constructed or tested for the application as safety relevant component or for the application in medical devices.

Our products are not qualified at module and system level for such application.

In case buyer – or customer supplied by buyer – considers using our components in product safety devices/ applications or medical devices/applications, buyer and/or customer has to inform our local sales partner immediately and we and buyer and /or customer will analyze and coordinate the customer-specific request between us and buyer and/or customer.

Glossary

- 1) **Brightness:** Brightness values are measured during a current pulse of typically 1 ms, with an internal reproducibility of $\pm 8\%$ and an expanded uncertainty of $\pm 11\%$ (acc. to GUM with a coverage factor of $k = 3$).
- 2) **Operating Temperature:** The Operating Temperature T_{op} is referenced to the Solderpoint T_s of this device. Proper current derating must be observed to maintain junction temperature below the maximum.
- 3) **Reverse Operation:** This product is intended to be operated applying a forward current within the specified range. Applying any continuous reverse bias or forward bias below the voltage range of light emission shall be avoided because it may cause migration which can change the electro-optical characteristics or damage the LED.
- 4) **Chromaticity coordinate groups:** Chromaticity coordinates are measured during a current pulse of typically 1 ms, with an internal reproducibility of ± 0.005 and an expanded uncertainty of ± 0.01 (acc. to GUM with a coverage factor of $k = 3$).
- 5) **Forward Voltage:** The forward voltage is measured during a current pulse of typically 1 ms, with an internal reproducibility of $\pm 0.05\text{ V}$ and an expanded uncertainty of $\pm 0.1\text{ V}$ (acc. to GUM with a coverage factor of $k = 3$).
- 6) **Thermal Resistance:** $R_{th\ max}$ is based on statistic values (6σ).
- 7) **Typical Values:** Due to the special conditions of the manufacturing processes of semiconductor devices, the typical data or calculated correlations of technical parameters can only reflect statistical figures. These do not necessarily correspond to the actual parameters of each single product, which could differ from the typical data and calculated correlations or the typical characteristic line. If requested, e.g. because of technical improvements, these typ. data will be changed without any further notice.
- 8) **Characteristic curve:** In the range where the line of the graph is broken, you must expect higher differences between single devices within one packing unit.
- 9) **Tolerance of Measure:** Unless otherwise noted in drawing, tolerances are specified with ± 0.1 and dimensions are specified in mm.
- 10) **Tape and Reel:** All dimensions and tolerances are specified acc. IEC 60286-3 and specified in mm.

Revision History

Version	Date	Change
1.0	2022-02-23	New Layout Initial Version
1.1	2022-07-28	Description Applications



EU RoHS and China RoHS compliant product

此产品符合欧盟 RoHS 指令的要求；
按照中国的相关法规和标准，
不含有毒有害物质或元素。

Published by ams-OSRAM AG

Tobelbader Strasse 30, 8141 Premstaetten, Austria

Phone +43 3136 500-0

ams-osram.com

© All rights reserved

am 

OSRAM