

KW DCLMS2.EC

TOPLED® E3014

The TOPLED Compact 3014 has a wide beam angle with a compact format (3.0 mm x 1.4 mm) and is a very small LED for screen backlighting. It is therefore ideal for injecting in light guides for homogeneous illumination applications where the TOPLED Compact 3014 never fails to impress with its performance on system level.



Applications

- Electronic Equipment
- White Goods

Features:

- Package: white SMT package, colored silicone resin
- Chip technology: InGaN on Sapphire
- Typ. Radiation: 120° (Lambertian emitter)
- Color: Cx = 0.35, Cy = 0.35 acc. to CIE 1931 (• white)
- Corrosion Robustness Class: 1B
- Color temperature: 4000K - 8000K
- CRI: 80 (min.)
- ESD: 8 kV acc. to ANSI/ESDA/JEDEC JS-001 (HBM, Class 3B)

Ordering Information

Type	Color temperature	Luminous Intensity ¹⁾ $I_F = 20 \text{ mA}$ I_v	Ordering Code
KW DCLMS2.EC-CXCZ-4L7M-1	4000 K	2800 ... 4500 mcd	Q65113A1683
KW DCLMS2.EC-CXCZ-4J7K-1	4500 K	2800 ... 4500 mcd	Q65113A1684
KW DCLMS2.EC-CXCZ-4H7I-1	5000 K	2800 ... 4500 mcd	Q65113A1685
KW DCLMS2.EC-CXCZ-4A7D-1	8000 K	2800 ... 4500 mcd	Q65113A1686

Maximum Ratings

Parameter	Symbol		Values
Operating Temperature	T_{op}	min. max.	-40 °C 85 °C
Storage Temperature	T_{stg}	min. max.	-40 °C 100 °C
Junction Temperature	T_j	max.	125 °C
Forward current $T_s = 25\text{ °C}$	I_F	min. max.	2 mA 30 mA
Surge Current $t \leq 10000\ \mu\text{s}; D = 0.1; T_s = 25\text{ °C}$	I_{FS}	max.	100 mA
ESD withstand voltage acc. to ANSI/ESDA/JEDEC JS-001 (HBM, Class 3B)	V_{ESD}		8 kV
Reverse voltage ²⁾	V_R		Not designed for reverse operation

Characteristics

$I_F = 20 \text{ mA}$; $T_s = 25 \text{ °C}$

Parameter	Symbol		Values
Chromaticity Coordinate ³⁾	C_x	typ.	0.35
	C_y	typ.	0.35
Viewing angle at 50% I_V	2ϕ	typ.	120 °
Forward Voltage ⁴⁾ $I_F = 20 \text{ mA}$	V_F	min.	2.60 V
		typ.	2.70 V
		max.	2.90 V
Reverse current ²⁾	I_R		Not designed for reverse operation
Color Rendering Index	CRI	min.	80
Real thermal resistance junction/solderpoint ⁵⁾	$R_{thJS \text{ real}}$	typ.	72 K / W
		max.	87 K / W
Electrical thermal resistance junction/solderpoint ⁵⁾ with efficiency $\eta_e = 55 \%$	$R_{thJS \text{ elec.}}$	typ.	32 K / W
		max.	39 K / W

Brightness Groups

Group	Luminous Intensity ¹⁾ $I_F = 20 \text{ mA}$ min. I_v	Luminous Intensity. ¹⁾ $I_F = 20 \text{ mA}$ max. I_v	Luminous Flux ⁶⁾ $I_F = 20 \text{ mA}$ typ. Φ_v
CX	2800 mcd	3300 mcd	9150 mlm
CY	3300 mcd	3900 mcd	10800 mlm
CZ	3900 mcd	4500 mcd	12600 mlm

Forward Voltage Groups

Group	Forward Voltage ⁴⁾ $I_F = 20 \text{ mA}$ min. V_F	Forward Voltage ⁴⁾ $I_F = 20 \text{ mA}$ max. V_F
K1	2.60 V	2.70 V
K2	2.70 V	2.80 V
L1	2.80 V	2.90 V

Chromaticity Coordinate Groups

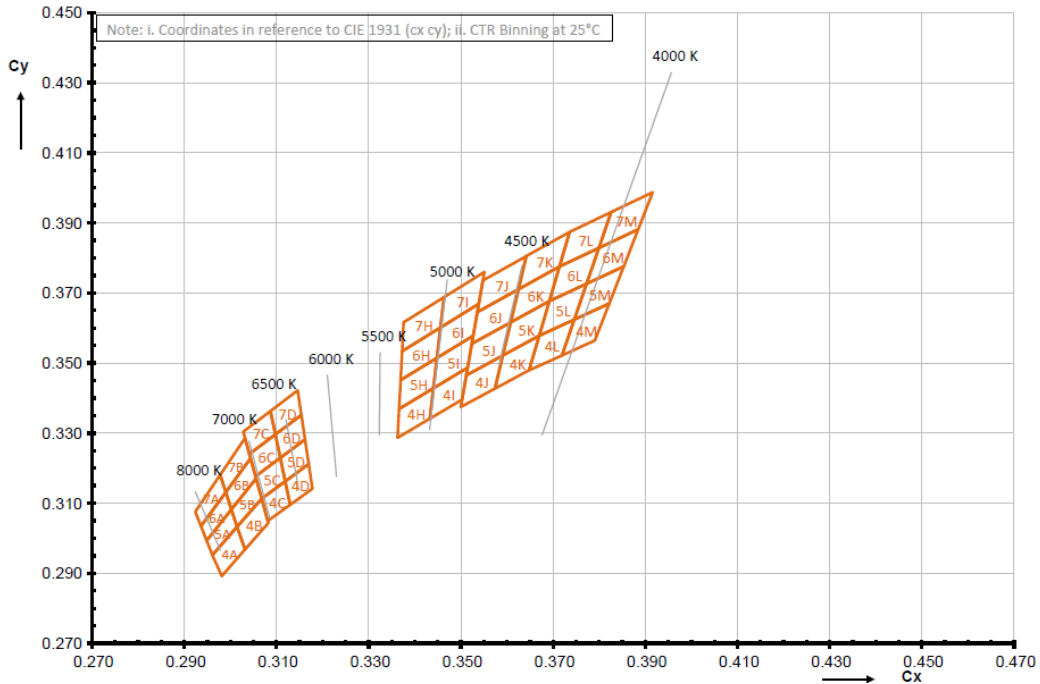

Chromaticity Coordinate Groups ³⁾

Group	Cx	Cy	CCT	Group	Cx	Cy	CCT	Group	Cx	Cy	CCT
4L	0.3648	0.3479	4000	6L	0.3692	0.3677	4000	4J	0.3500	0.3375	4500
	0.3670	0.3578	4000		0.3714	0.3775	4000		0.3512	0.3465	4500
	0.3746	0.3624	4000		0.3799	0.3828	4000		0.3591	0.3522	4500
	0.3719	0.3522	4000		0.3773	0.3726	4000		0.3574	0.3427	4500
4M	0.3719	0.3522	4000	6M	0.3773	0.3726	4000	4K	0.3574	0.3427	4500
	0.3746	0.3624	4000		0.3799	0.3828	4000		0.3591	0.3522	4500
	0.3822	0.3670	4000		0.3885	0.3882	4000		0.3670	0.3578	4500
	0.3791	0.3564	4000		0.3853	0.3776	4000		0.3648	0.3479	4500
5L	0.3670	0.3578	4000	7L	0.3714	0.3775	4000	5J	0.3512	0.3465	4500
	0.3692	0.3677	4000		0.3736	0.3874	4000		0.3524	0.3555	4500
	0.3773	0.3726	4000		0.3826	0.3931	4000		0.3608	0.3616	4500
	0.3746	0.3624	4000		0.3799	0.3828	4000		0.3591	0.3522	4500
5M	0.3746	0.3624	4000	7M	0.3799	0.3828	4000	5K	0.3591	0.3522	4500
	0.3773	0.3726	4000		0.3826	0.3931	4000		0.3608	0.3616	4500
	0.3853	0.3776	4000		0.3916	0.3987	4000		0.3692	0.3677	4500
	0.3822	0.3670	4000		0.3885	0.3882	4000		0.3670	0.3578	4500

Group	Cx	Cy	CCT	Group	Cx	Cy	CCT	Group	Cx	Cy	CCT
6J	0.3524	0.3555	4500	6H	0.3369	0.3451	5000	5A	0.2961	0.2952	8000
	0.3536	0.3646	4500		0.3373	0.3534	5000		0.2949	0.2993	8000
	0.3625	0.3711	4500		0.3456	0.3601	5000		0.3002	0.3082	8000
	0.3608	0.3616	4500		0.3448	0.3515	5000		0.3015	0.3033	8000
6K	0.3608	0.3616	4500	6I	0.3448	0.3515	5000	5B	0.3015	0.3033	8000
	0.3625	0.3711	4500		0.3456	0.3601	5000		0.3002	0.3082	8000
	0.3714	0.3775	4500		0.3539	0.3669	5000		0.3056	0.3171	8000
	0.3692	0.3677	4500		0.3527	0.3578	5000		0.3068	0.3113	8000
7J	0.3536	0.3646	4500	7H	0.3373	0.3534	5000	5C	0.3068	0.3113	8000
	0.3548	0.3736	4500		0.3376	0.3616	5000		0.3055	0.3177	8000
	0.3642	0.3805	4500		0.3464	0.3688	5000		0.3108	0.3229	8000
	0.3625	0.3711	4500		0.3456	0.3601	5000		0.3119	0.3162	8000
7K	0.3625	0.3711	4500	7I	0.3456	0.3601	5000	5D	0.3119	0.3162	8000
	0.3642	0.3805	4500		0.3464	0.3688	5000		0.3108	0.3229	8000
	0.3736	0.3874	4500		0.3551	0.3760	5000		0.3162	0.3282	8000
	0.3714	0.3775	4500		0.3539	0.3669	5000		0.3170	0.3212	8000
4H	0.3363	0.3287	5000	4A	0.2981	0.2892	8000	6A	0.2949	0.2993	8000
	0.3366	0.3369	5000		0.2961	0.2952	8000		0.2936	0.3034	8000
	0.3441	0.3428	5000		0.3015	0.3033	8000		0.2990	0.3131	8000
	0.3433	0.3341	5000		0.3032	0.2968	8000		0.3002	0.3082	8000
4I	0.3433	0.3341	5000	4B	0.3032	0.2968	8000	6B	0.3002	0.3082	8000
	0.3441	0.3428	5000		0.3015	0.3033	8000		0.2990	0.3131	8000
	0.3515	0.3487	5000		0.3068	0.3113	8000		0.3044	0.3228	8000
	0.3503	0.3396	5000		0.3083	0.3044	8000		0.3056	0.3171	8000
5H	0.3366	0.3369	5000	4C	0.3081	0.3049	8000	6C	0.3055	0.3177	8000
	0.3369	0.3451	5000		0.3068	0.3113	8000		0.3041	0.3240	8000
	0.3448	0.3515	5000		0.3119	0.3162	8000		0.3098	0.3296	8000
	0.3441	0.3428	5000		0.3130	0.3095	8000		0.3108	0.3229	8000
5I	0.3441	0.3428	5000	4D	0.3130	0.3095	8000	6D	0.3108	0.3229	8000
	0.3448	0.3515	5000		0.3119	0.3162	8000		0.3098	0.3296	8000
	0.3527	0.3578	5000		0.3170	0.3212	8000		0.3154	0.3352	8000
	0.3515	0.3487	5000		0.3178	0.3142	8000		0.3162	0.3282	8000

Group	Cx	Cy	CCT	Group	Cx	Cy	CCT
7A	0.2936	0.3034	8000	7C	0.3041	0.3240	8000
	0.2924	0.3076	8000		0.3028	0.3304	8000
	0.2978	0.3181	8000		0.3087	0.3363	8000
	0.2990	0.3131	8000		0.3098	0.3296	8000
7B	0.2990	0.3131	8000	7D	0.3098	0.3296	8000
	0.2978	0.3181	8000		0.3087	0.3363	8000
	0.3032	0.3286	8000		0.3146	0.3422	8000
	0.3044	0.3228	8000		0.3154	0.3352	8000

Group Name on Label

Example: CX-4A-K1

Brightness

Color Chromaticity

Forward Voltage

CX

4A

K1

Relative Spectral Emission ⁶⁾

$I_{rel} = f(\lambda); I_F = 20 \text{ mA}; T_S = 25 \text{ }^\circ\text{C}$

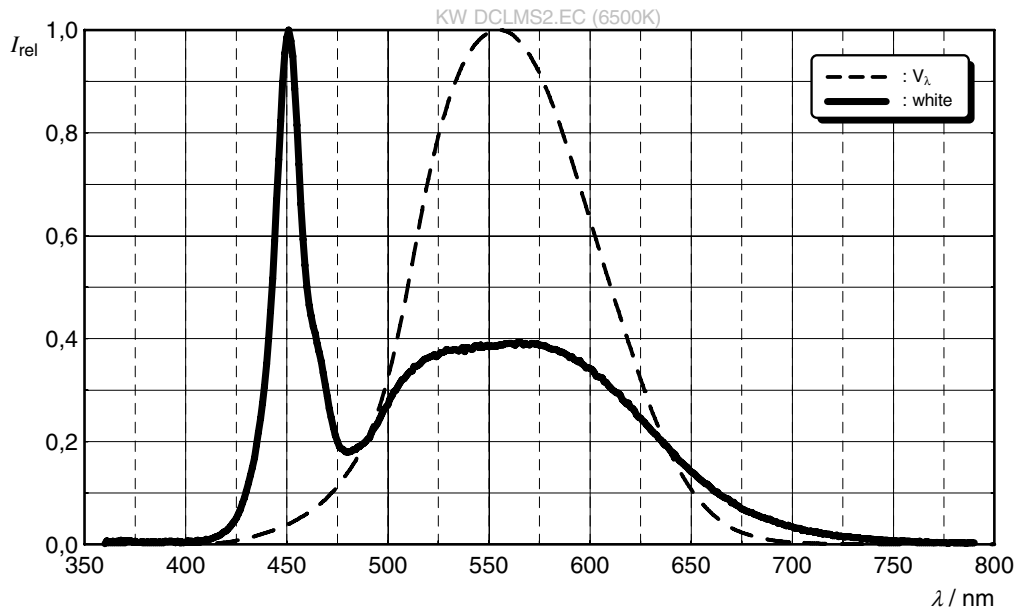

Radiation Characteristics ⁶⁾

$I_{rel} = f(\phi); T_S = 25 \text{ }^\circ\text{C}$

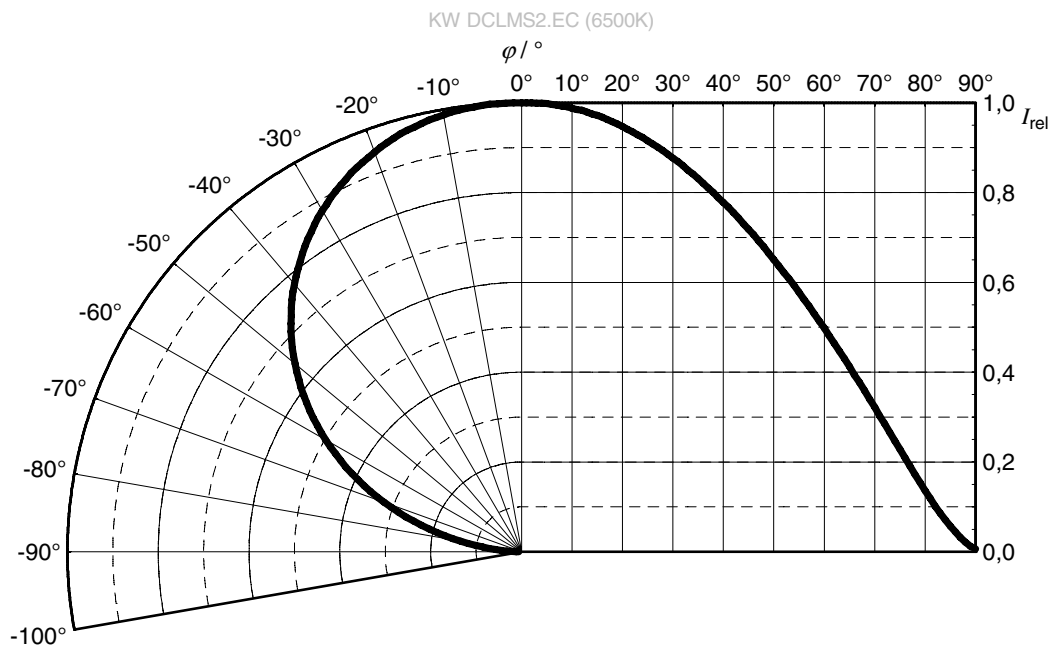

Forward current ⁶⁾

$$I_F = f(V_F); T_S = 25 \text{ }^\circ\text{C}$$

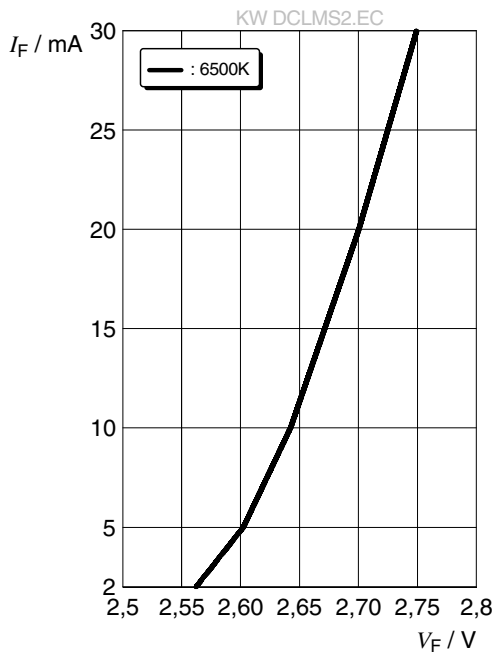

Relative Luminous Intensity ^{6), 7)}

$$I_V/I_V(20 \text{ mA}) = f(I_F); T_S = 25 \text{ }^\circ\text{C}$$

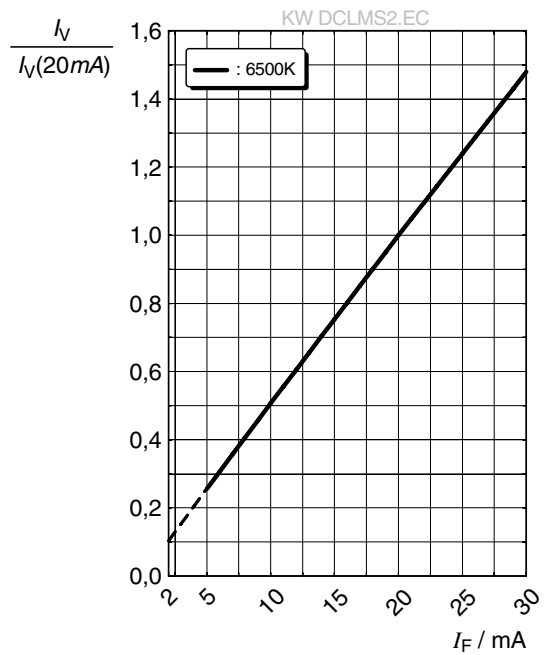

Chromaticity Coordinate Shift ⁶⁾

$$\Delta C_x, \Delta C_y = f(I_F); T_S = 25 \text{ }^\circ\text{C}$$

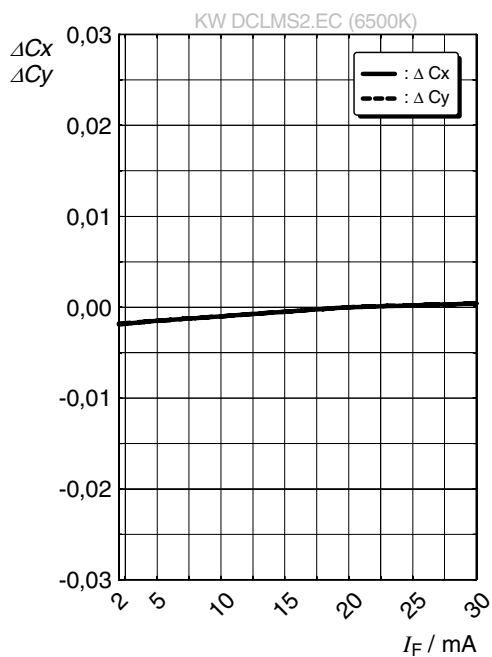

Forward Voltage ⁶⁾

$$\Delta V_F = V_F - V_F(25\text{ }^\circ\text{C}) = f(T_j); I_F = 20\text{ mA}$$

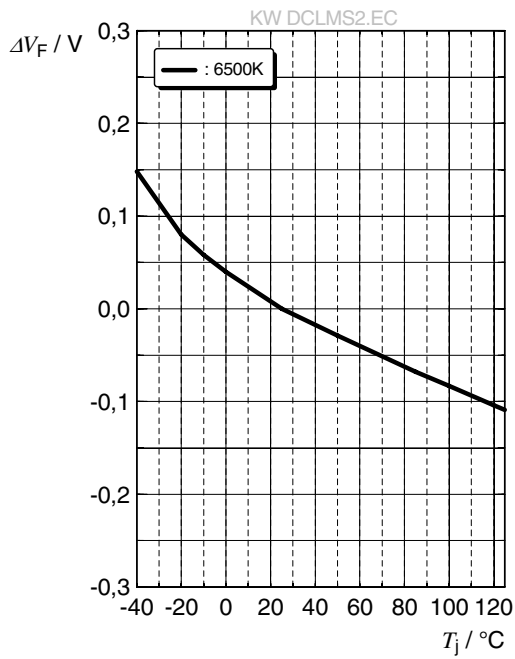

Relative Luminous Intensity ⁶⁾

$$I_V / I_V(25\text{ }^\circ\text{C}) = f(T_j); I_F = 20\text{ mA}$$

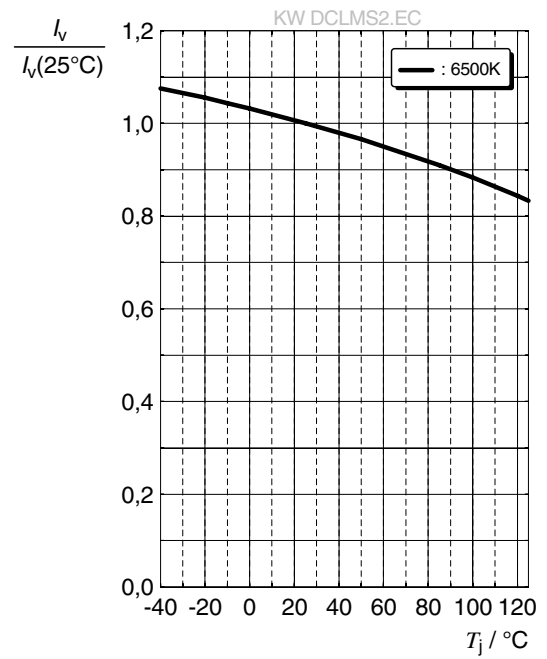

Chromaticity Coordinate Shift ⁶⁾

$$\Delta C_x, \Delta C_y = f(T_j); I_F = 20\text{ mA}$$

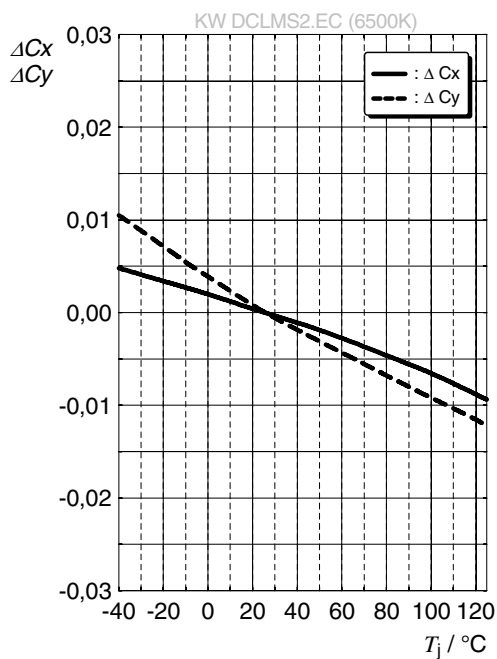

Max. Permissible Forward Current

$I_F = f(T)$

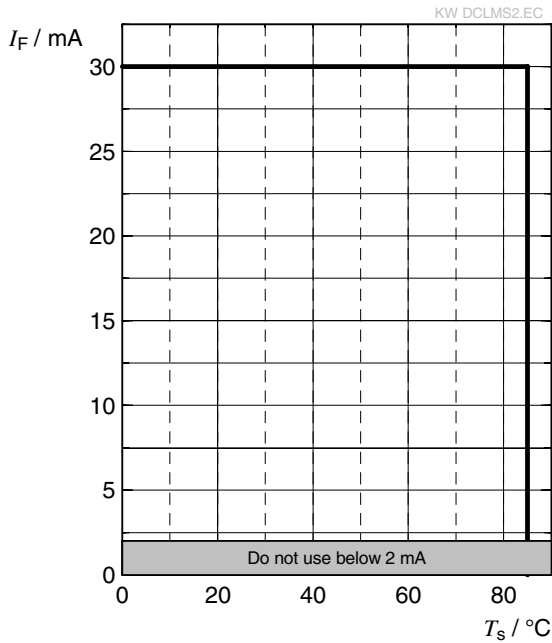

Permissible Pulse Handling Capability

$I_F = f(t_p)$; D: Duty cycle

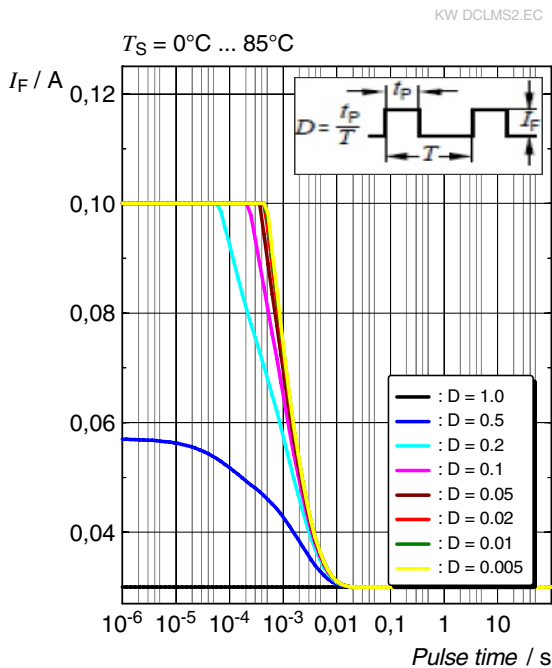

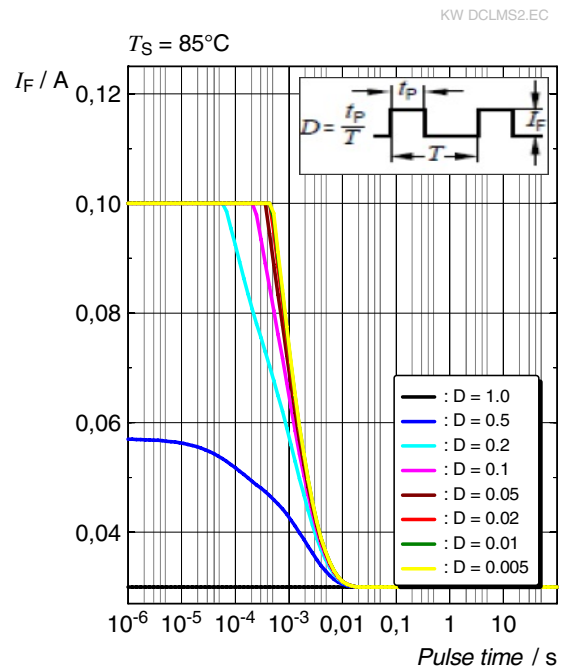

Permissible Pulse Handling Capability

$I_F = f(t_p)$; D: Duty cycle

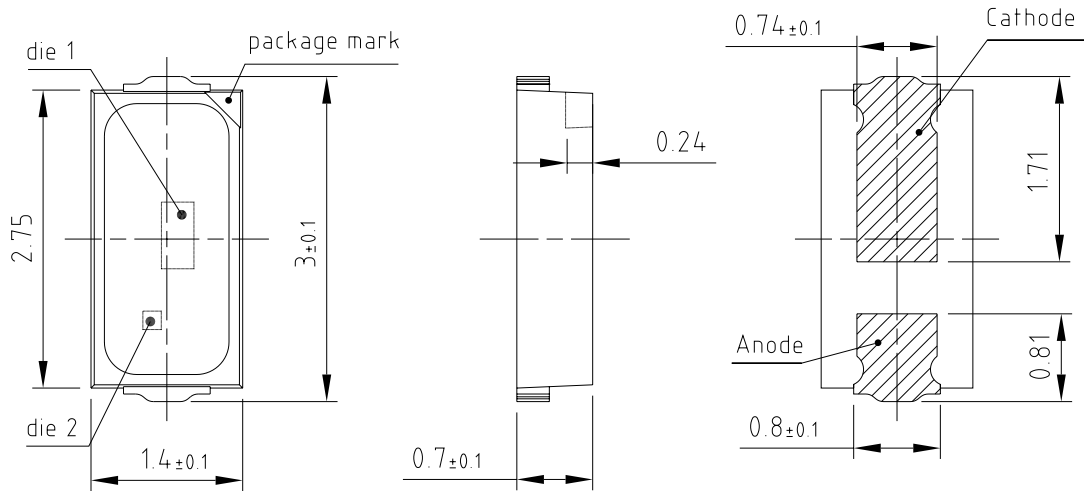

Dimensional Drawing ⁸⁾



General tolerance ± 0.1
 lead finish Ag 

C67062-A0318-A5-02

Further Information:

Approximate Weight: 10.0 mg

Package marking: Cathode

Corrosion test: Class: 1B
 Test condition: 25°C / 75 % RH / 200ppb SO₂, 200ppb NO₂, 10ppb H₂S,
 10ppb Cl₂ / 21 days (EN 60068-2-60 (Method 4))

ESD advice: LED is protected by ESD device which is connected in parallel to LED-Chip.

Recommended Solder Pad ⁸⁾

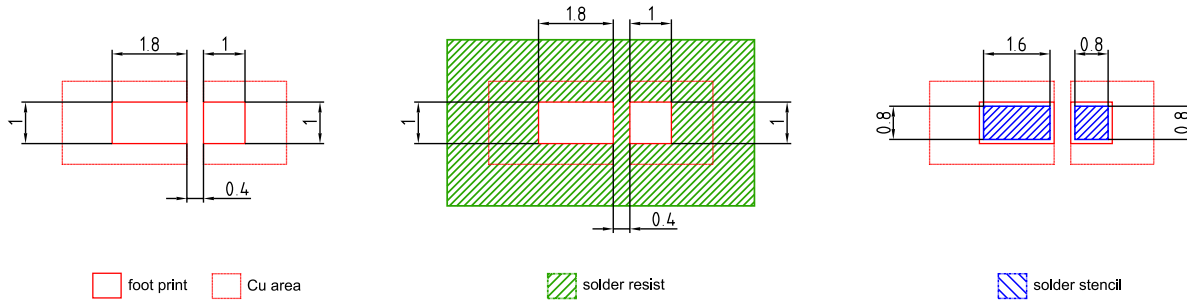

E067.0374.01 -01

For superior solder joint connectivity results we recommend soldering under standard nitrogen atmosphere. Package not suitable for ultra sonic cleaning.

Reflow Soldering Profile

Product complies to MSL Level 3 acc. to JEDEC J-STD-020E

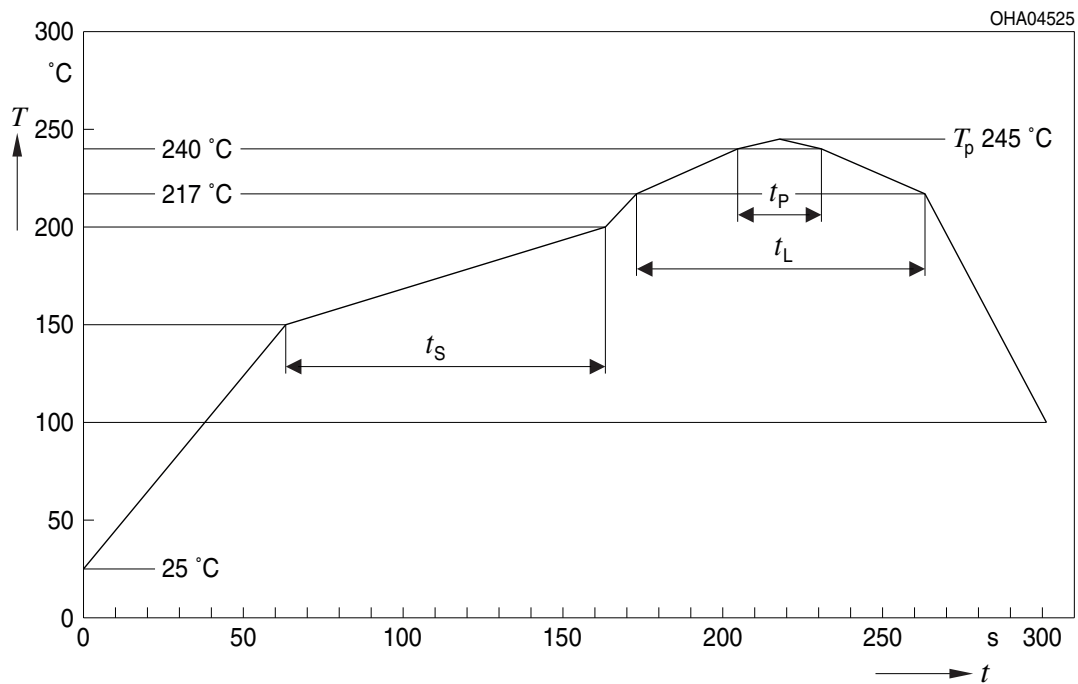

Profile Feature	Symbol	Pb-Free (SnAgCu) Assembly			Unit
		Minimum	Recommendation	Maximum	
Ramp-up rate to preheat ^{*)} 25 °C to 150 °C			2	3	K/s
Time t_s T_{Smin} to T_{Smax}	t_s	60	100	120	s
Ramp-up rate to peak ^{*)} T_{Smax} to T_p			2	3	K/s
Liquidus temperature	T_L		217		°C
Time above liquidus temperature	t_L		80	100	s
Peak temperature	T_p		245	260	°C
Time within 5 °C of the specified peak temperature $T_p - 5$ K	t_p	10	20	30	s
Ramp-down rate* T_p to 100 °C			3	6	K/s
Time 25 °C to T_p				480	s

All temperatures refer to the center of the package, measured on the top of the component

* slope calculation DT/Dt : Dt max. 5 s; fulfillment for the whole T-range

Taping ⁸⁾

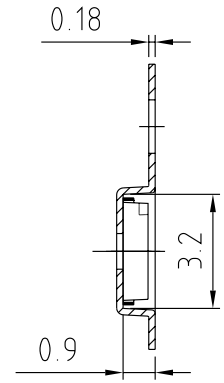
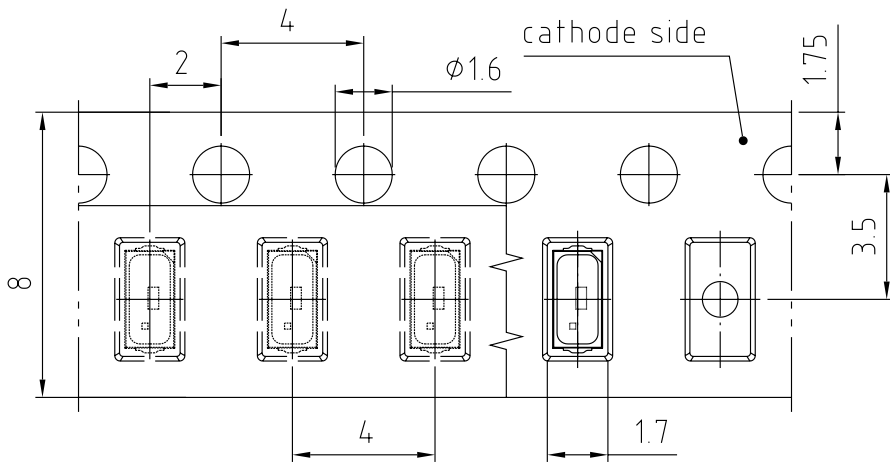

C67062-A0318-B3-02

Tape and Reel ⁹⁾

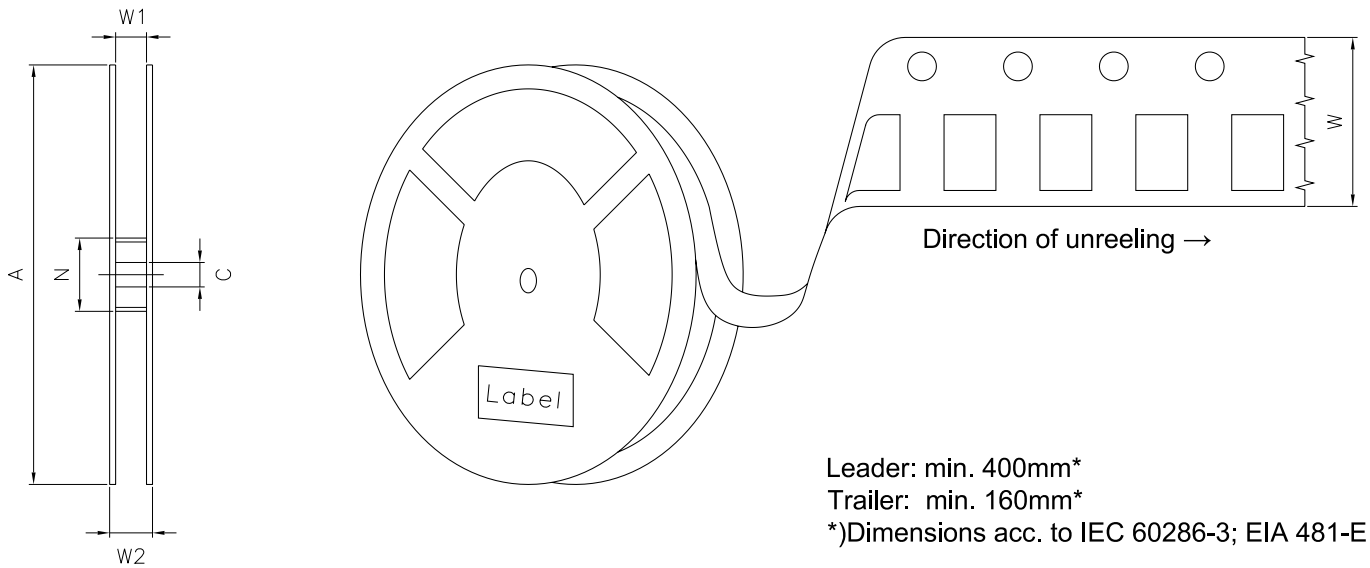

Reel Dimensions

A	W	N_{\min}	W_1	$W_{2\max}$	Pieces per PU
180 mm	$8 + 0.3 / - 0.1$ mm	60 mm	$8.4 + 2$ mm	14.4 mm	3000

Barcode-Product-Label (BPL)

OSRAM Opto Semiconductors LX XXXX BIN1: XX-XX-X-XXX-X

RoHS Compliant

(6P) BATCH NO: 1234567890 ML Temp ST
X XXX °C X

(1T) LOT NO: 1234567890 (9D) D/C: 1234

(X) PROD NO: 123456789(Q)QTY: 9999 (G) GROUP: XX-XX-X-X

Pack: RXX
DEMY XXX
X_X123_1234.1234 X



OHA04563

Dry Packing Process and Materials ⁸⁾

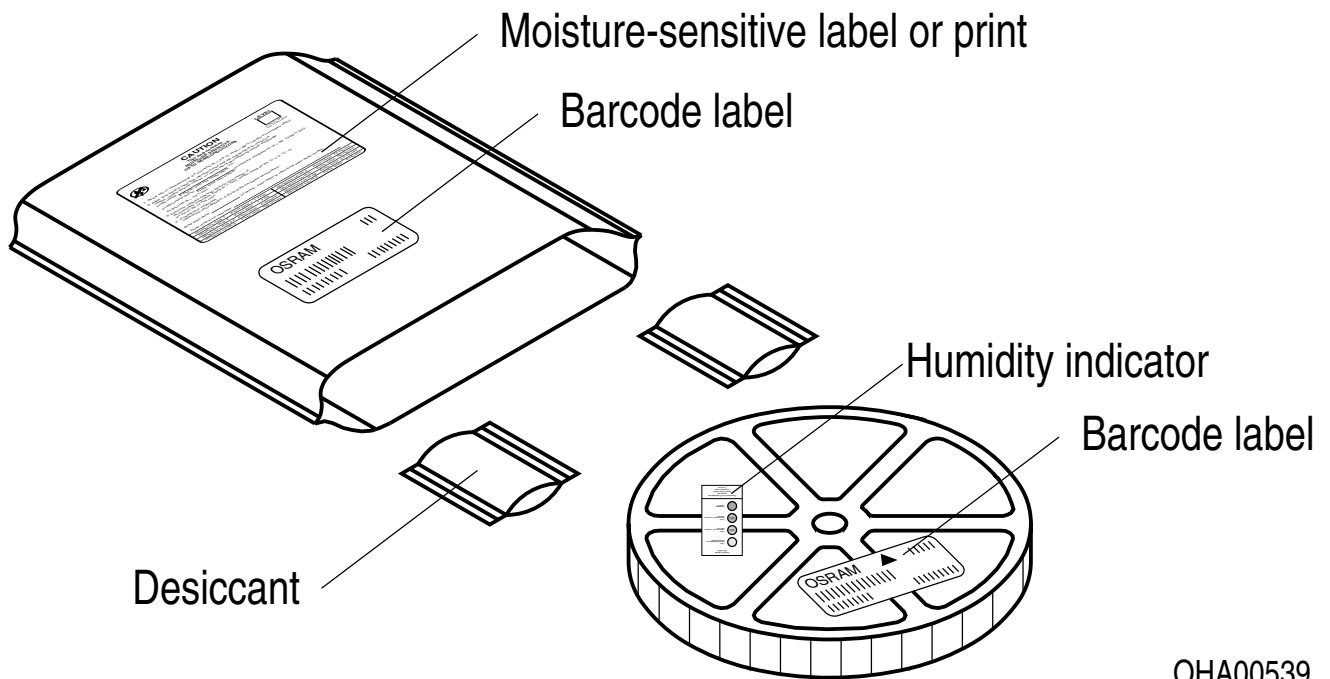

OHA00539

Moisture-sensitive product is packed in a dry bag containing desiccant and a humidity card according JEDEC-STD-033.

Notes

The evaluation of eye safety occurs according to the standard IEC 62471:2006 (photo biological safety of lamps and lamp systems). Within the risk grouping system of this IEC standard, the device specified in this data sheet fall into the class **exempt group (exposure time 10000 s)**. Under real circumstances (for exposure time, conditions of the eye pupils, observation distance), it is assumed that no endangerment to the eye exists from these devices. As a matter of principle, however, it should be mentioned that intense light sources have a high secondary exposure potential due to their blinding effect. When looking at bright light sources (e.g. headlights), temporary reduction in visual acuity and afterimages can occur, leading to irritation, annoyance, visual impairment, and even accidents, depending on the situation.

Subcomponents of this device contain, in addition to other substances, metal filled materials including silver. Metal filled materials can be affected by environments that contain traces of aggressive substances. Therefore, we recommend that customers minimize device exposure to aggressive substances during storage, production, and use. Devices that showed visible discoloration when tested using the described tests above did show no performance deviations within failure limits during the stated test duration. Respective failure limits are described in the IEC60810.

For further application related information please visit www.osram-os.com/appnotes

Disclaimer

Attention please!

The information describes the type of component and shall not be considered as assured characteristics. Terms of delivery and rights to change design reserved. Due to technical requirements components may contain dangerous substances.

For information on the types in question please contact our Sales Organization.

If printed or downloaded, please find the latest version on the OSRAM OS website.

Packing

Please use the recycling operators known to you. We can also help you – get in touch with your nearest sales office. By agreement we will take packing material back, if it is sorted. You must bear the costs of transport. For packing material that is returned to us unsorted or which we are not obliged to accept, we shall have to invoice you for any costs incurred.

Product and functional safety devices/applications or medical devices/applications

OSRAM OS components are not developed, constructed or tested for the application as safety relevant component or for the application in medical devices.

OSRAM OS products are not qualified at module and system level for such application.

In case buyer – or customer supplied by buyer – considers using OSRAM OS components in product safety devices/applications or medical devices/applications, buyer and/or customer has to inform the local sales partner of OSRAM OS immediately and OSRAM OS and buyer and /or customer will analyze and coordinate the customer-specific request between OSRAM OS and buyer and/or customer.

Glossary

- 1) **Brightness:** Brightness groups are tested at a current pulse duration of 25 ms and a tolerance of $\pm 11\%$.
- 2) **Reverse Operation:** Not designed for reverse operation. Continuous reverse operation can cause migration and damage of the device.
- 3) **Chromaticity coordinate groups:** Chromaticity coordinate groups are tested at a current pulse duration of 25 ms and a tolerance of ± 0.01 .
- 4) **Forward Voltage:** Forward voltages are tested at a current pulse duration of 1 ms and a tolerance of ± 0.1 V.
- 5) **Thermal Resistance:** $R_{th\ max}$ is based on statistic values (6σ).
- 6) **Typical Values:** Due to the special conditions of the manufacturing processes of semiconductor devices, the typical data or calculated correlations of technical parameters can only reflect statistical figures. These do not necessarily correspond to the actual parameters of each single product, which could differ from the typical data and calculated correlations or the typical characteristic line. If requested, e.g. because of technical improvements, these typ. data will be changed without any further notice.
- 7) **Characteristic curve:** In the range where the line of the graph is broken, you must expect higher differences between single devices within one packing unit.
- 8) **Tolerance of Measure:** Unless otherwise noted in drawing, tolerances are specified with ± 0.1 and dimensions are specified in mm.
- 9) **Tape and Reel:** All dimensions and tolerances are specified acc. IEC 60286-3 and specified in mm.

Revision History

Version	Date	Change
1.0	2020-10-05	Initial Version
1.1	2020-10-23	Characteristics Derating (Diagrams)
1.2	2021-09-24	Characteristics

Published by OSRAM Opto Semiconductors GmbH EU RoHS and China RoHS compliant product
Leibnizstraße 4, D-93055 Regensburg
www.osram-os.com © All Rights Reserved.



此产品符合欧盟 RoHS 指令的要求；
按照中国的相关法规和标准，不含有毒有害物质或元素。