

# OSRAM KRTBAELPS1.32

## Datasheet

Published by **ams-OSRAM AG**

Tobelbader Strasse 30, 8141 Premstaetten, Austria

Phone +43 3136 500-0

[ams-osram.com](http://ams-osram.com)

© All rights reserved



OSIRE® E5515

# KRTB AELPS1.32

The ams OSRAM OSIRE KRTB AELPS1.32 RGB sidelooker device is specifically designed for automotive interior applications. It offers individually addressable LED chips for a maximum of flexibility in terms of color point, driver selection and interconnection. Due to the low profile, the OSIRE KRTB AELPS1.32 is ideally suited for coupling into thin lightguides and enables ultra compact designs.



## Applications

- Ambient Lighting
- Automotive Aftermarket
- Functional Illumination

## Features

- Package: white SMT package, colorless clear silicone resin
- Chip technology: Thinfilm / UX:3
- Typ. Radiation: 120° (Lambertian emitter)
- Color:  $\lambda_{\text{dom}} = 625 \text{ nm}$  (● red);  $\lambda_{\text{dom}} = 528 \text{ nm}$  (● true green);  $\lambda_{\text{dom}} = 465 \text{ nm}$  (● blue)
- Corrosion Robustness Class: 3B
- Qualifications: AEC-Q102 Qualified
- ESD: 2 kV acc. to ANSI/ESDA/JEDEC JS-001 (HBM, Class 2)

## Ordering Information

Type	Brightness <sup>1)</sup>	Ordering Code
KRTBAELPS1.32-1V7A-JW+6B5C-D8+4S4U-7Z		Q65113A4017
• red	• $I_v = 710 \dots 1590 \text{ mcd}$ ( $I_F = 20 \text{ mA}$ )	
• true green	• $I_v = 2010 \dots 3150 \text{ mcd}$ ( $I_F = 20 \text{ mA}$ )	
• blue	• $I_v = 250 \dots 710 \text{ mcd}$ ( $I_F = 20 \text{ mA}$ )	

## Maximum Ratings

Parameter	Symbol		Values	Values	Values
			● red	● true green	● blue
Operating Temperature	$T_{op}$	min.	-40 °C	-40 °C	-40 °C
		max.	110 °C	110 °C	110 °C
Storage Temperature	$T_{stg}$	min.	-40 °C	-40 °C	-40 °C
		max.	110 °C	110 °C	110 °C
Junction Temperature	$T_j$	max.	125 °C	125 °C	125 °C
Forward Current $T_s = 25\text{ °C}$	$I_F$	min.	5 mA	5 mA	5 mA
		max.	50 mA	50 mA	50 mA
Surge Current $t \leq 10\ \mu\text{s}$ ; $D = 0.005$ ; $T_s = 25\text{ °C}$	$I_{FS}$	max.	100 mA	300 mA	300 mA
Reverse voltage <sup>2)</sup> $T_s = 25\text{ °C}$	$V_R$	max.	12 V	5 V	5 V
ESD withstand voltage acc. to ANSI/ESDA/JEDEC JS-001 (HBM, Class 2)	$V_{ESD}$		2 kV	2 kV	2 kV

## Characteristics

$I_F = 20 \text{ mA}$ ;  $T_s = 25 \text{ °C}$

Parameter	Symbol		Values	Values	Values
			● red	● true green	● blue
Peak Wavelength	$\lambda_{\text{peak}}$	typ.	632 nm	523 nm	462 nm
Dominant Wavelength <sup>3)</sup>	$\lambda_{\text{dom}}$	min.	620 nm	519 nm	447 nm
		typ.	625 nm	528 nm	465 nm
		max.	632 nm	546 nm	476 nm
Spectral bandwidth at 50% $I_{\text{rel,max}}$	$\Delta\lambda$	typ.	18 nm	33 nm	25 nm
Viewing angle at 50% $I_V$	$2\varphi$	typ.	120 °	120 °	120 °
Forward Voltage <sup>4)</sup> $I_F = 20 \text{ mA}$	$V_F$	min.	1.60 V	2.10 V	2.50 V
		typ.	1.95 V	2.60 V	2.85 V
		max.	2.30 V	3.00 V	3.20 V
Real thermal resistance junction/solderpoint <sup>5)</sup>	$R_{\text{thJS real}}$	typ.	53 K / W	38 K / W	30 K / W
		max.	78 K / W	52 K / W	48 K / W

## Brightness Groups

Color of emission	Group	Luminous Intensity <sup>1)</sup> $I_F = 20 \text{ mA}$ min. $I_v$	Luminous Intensity <sup>1)</sup> $I_F = 20 \text{ mA}$ max. $I_v$
• red	1V	710 mcd	800 mcd
• red	2V	800 mcd	900 mcd
• red	3V	900 mcd	1000 mcd
• red	4V	1000 mcd	1120 mcd
• red	5A	1120 mcd	1250 mcd
• red	6A	1250 mcd	1400 mcd
• red	7A	1400 mcd	1590 mcd
• true green	6B	2010 mcd	2240 mcd
• true green	7B	2240 mcd	2500 mcd
• true green	8B	2500 mcd	2800 mcd
• true green	5C	2800 mcd	3150 mcd
• blue	4S	250 mcd	280 mcd
• blue	1T	280 mcd	315 mcd
• blue	2T	315 mcd	355 mcd
• blue	3T	355 mcd	400 mcd
• blue	4T	400 mcd	450 mcd
• blue	1U	450 mcd	500 mcd
• blue	2U	500 mcd	560 mcd
• blue	3U	560 mcd	630 mcd
• blue	4U	630 mcd	710 mcd

## Wavelength Groups

- red

Group	Dominant Wavelength <sup>3)</sup>	Dominant Wavelength <sup>3)</sup>
	min. $\lambda_{\text{dom}}$	max. $\lambda_{\text{dom}}$
JP	620 nm	625 nm
MT	623 nm	629 nm
RW	627 nm	632 nm

## Wavelength Groups

- true green

Group	Dominant Wavelength <sup>3)</sup>	Dominant Wavelength <sup>3)</sup>
	min. $\lambda_{\text{dom}}$	max. $\lambda_{\text{dom}}$
DJ	519 nm	524 nm
FL	521 nm	526 nm
JP	524 nm	529 nm
LR	526 nm	531 nm
PU	529 nm	534 nm
RW	531 nm	536 nm
U3	534 nm	541 nm
18	539 nm	546 nm

## Wavelength Groups

- blue

Group	Dominant Wavelength <sup>3)</sup>	Dominant Wavelength <sup>3)</sup>
	min. $\lambda_{\text{dom}}$	max. $\lambda_{\text{dom}}$
73	447 nm	451 nm
51	449 nm	453 nm
3C	451 nm	456 nm
AF	454 nm	459 nm
DH	457 nm	461 nm
FK	459 nm	463 nm
HM	461 nm	465 nm
KP	463 nm	467 nm
MS	465 nm	470 nm
QV	468 nm	473 nm
TZ	471 nm	476 nm



### Chromaticity Coordinate Groups

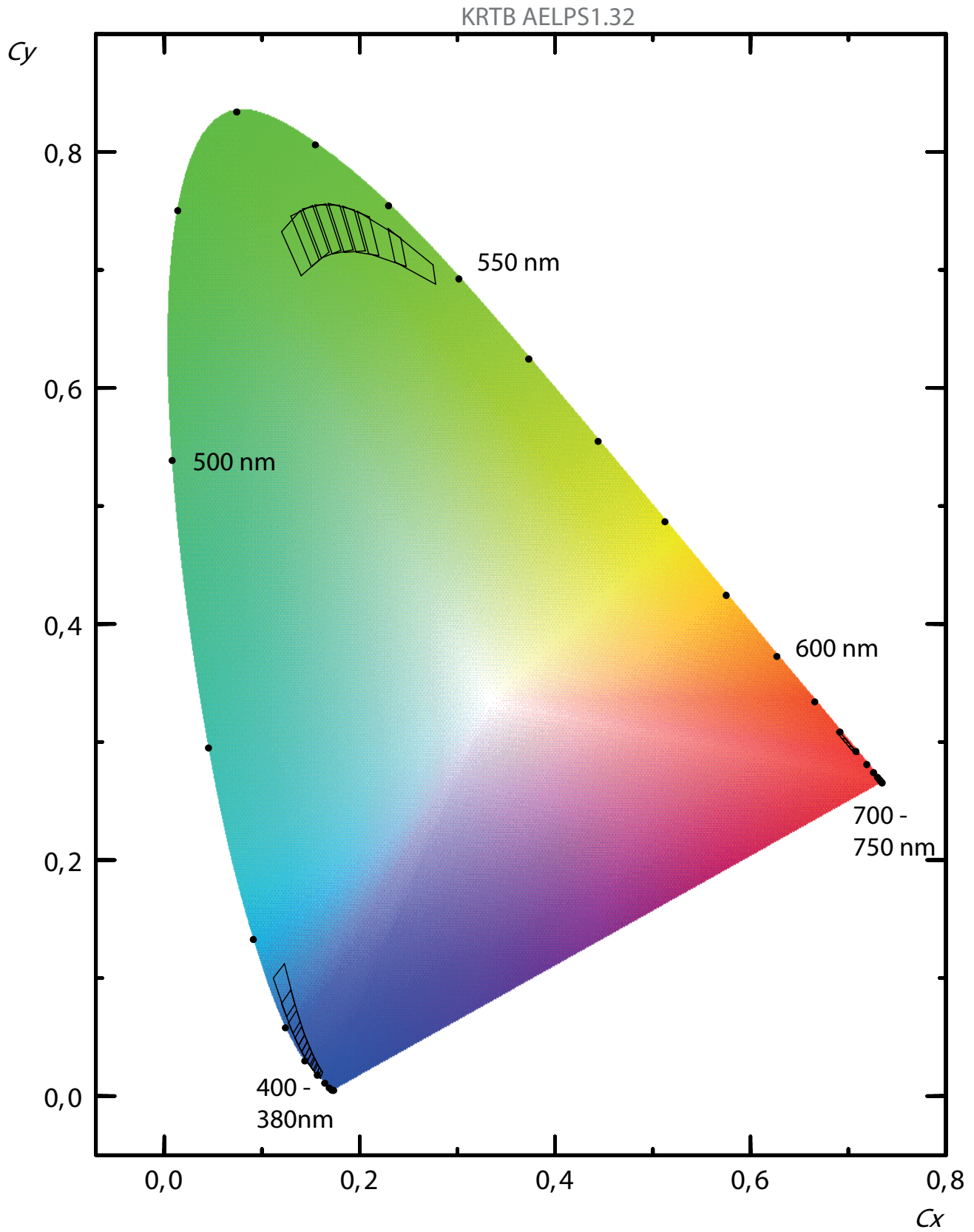

## Chromaticity Coordinate Groups

• red

Group	Cx	Cy
JP	0.6879	0.3086
	0.6915	0.3083
	0.7006	0.2993
	0.6969	0.2996
MT	0.6936	0.3030
	0.6972	0.3027
	0.7066	0.2934
	0.7028	0.2938
RW	0.7000	0.2966
	0.7037	0.2962
	0.7105	0.2895
	0.7067	0.2899

## Chromaticity Coordinate Groups

● true green

Group	Cx	Cy
18	0.2362	0.7067
	0.2288	0.7353
	0.2752	0.7042
	0.2776	0.6881
DJ	0.1401	0.6951
	0.1201	0.7325
	0.1415	0.7518
	0.1606	0.7102
FL	0.1486	0.7014
	0.1273	0.7439
	0.1517	0.7547
	0.1698	0.7127
JP	0.1606	0.7102
	0.1415	0.7518
	0.1679	0.7565
	0.1831	0.7174
LR	0.1694	0.7136
	0.1517	0.7547
	0.1794	0.7549
	0.1933	0.7170
PU	0.1831	0.7174
	0.1678	0.7565
	0.1973	0.7500
	0.2091	0.7142
RW	0.1932	0.7170
	0.1794	0.7549
	0.2098	0.7449
	0.2196	0.7122
U3	0.2091	0.7142
	0.1974	0.7500
	0.2419	0.7273
	0.2474	0.7029

## Chromaticity Coordinate Groups

- blue

Group	Cx	Cy
3C	0.1588	0.0243
	0.1556	0.0186
	0.1500	0.0246
	0.1543	0.0317
51	0.1606	0.0222
	0.1576	0.0168
	0.1534	0.0206
	0.1570	0.0268
73	0.1622	0.0203
	0.1595	0.0152
	0.1556	0.0186
	0.1588	0.0243
AF	0.1562	0.0285
	0.1524	0.0219
	0.1462	0.0293
	0.1509	0.0370
DH	0.1532	0.0332
	0.1489	0.0262
	0.1436	0.0332
	0.1487	0.0414
FK	0.1509	0.0370
	0.1462	0.0293
	0.1407	0.0376
	0.1463	0.0463
HM	0.1487	0.0414
	0.1436	0.0332
	0.1375	0.0428
	0.1436	0.0519
KP	0.1463	0.0463
	0.1407	0.0376
	0.1338	0.0493
	0.1404	0.0588

## Chromaticity Coordinate Groups

- blue

Group	Cx	Cy
MS	0.1436	0.0519
	0.1375	0.0428
	0.1272	0.0620
	0.1354	0.0727
QV	0.1389	0.0631
	0.1317	0.0532
	0.1199	0.0785
	0.1295	0.0899
TZ	0.1335	0.0779
	0.1251	0.0672
	0.1115	0.1000
	0.1231	0.1122

### Relative Spectral Emission <sup>6)</sup>

$I_{rel} = f(\lambda)$ ;  $I_F = 20 \text{ mA}$ ;  $T_S = 25 \text{ }^\circ\text{C}$

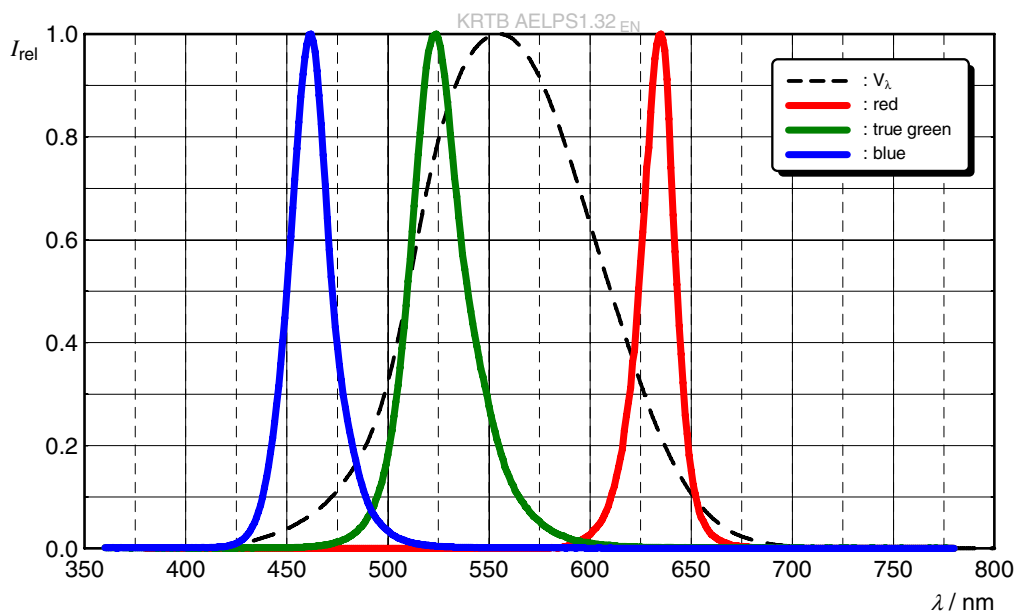

### Radiation Characteristics <sup>6)</sup>

$I_{rel} = f(\phi)$ ;  $T_S = 25 \text{ }^\circ\text{C}$

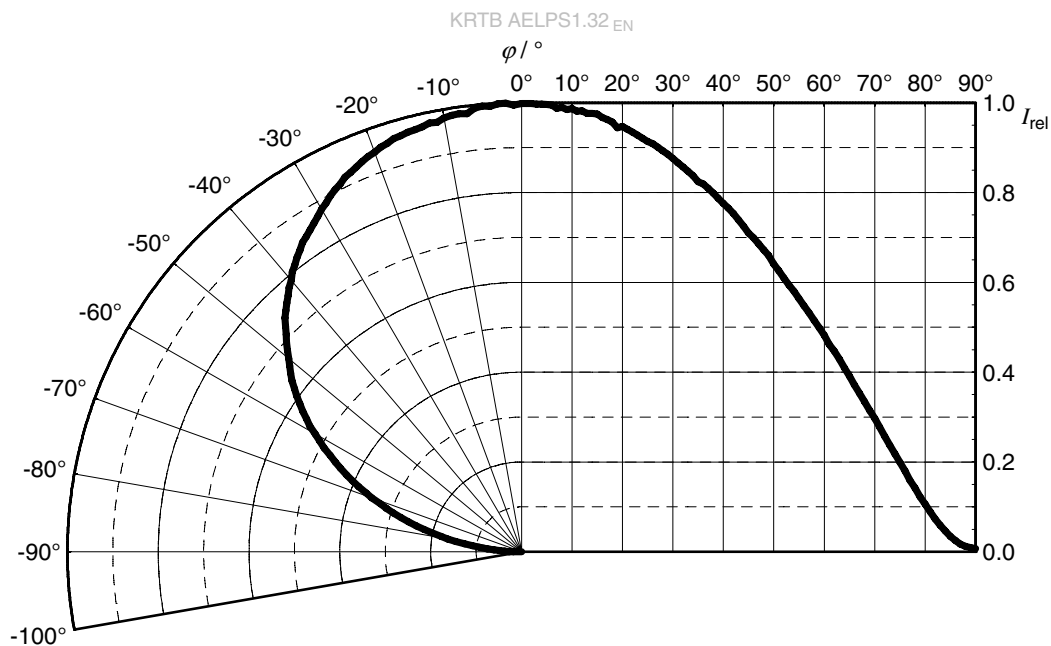

**Forward current** <sup>6)</sup>

$I_F = f(V_F); T_S = 25\text{ °C}$

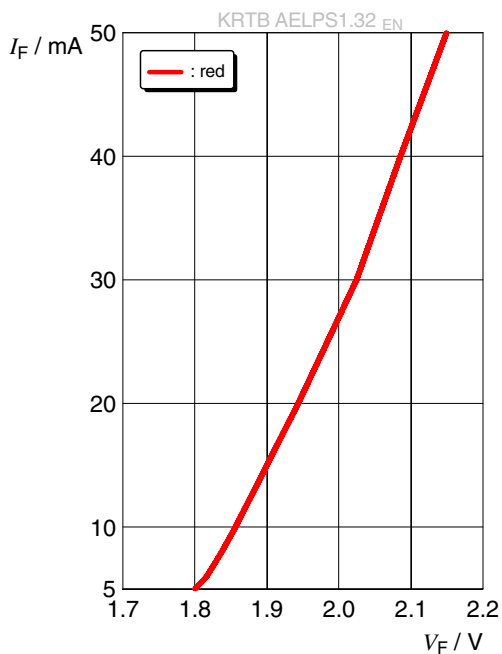

**Forward current** <sup>6)</sup>

$I_F = f(V_F); T_S = 25\text{ °C}$

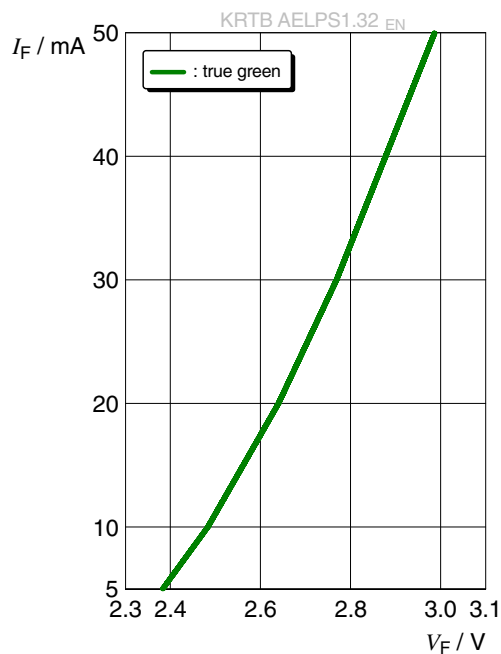

**Forward current** <sup>6)</sup>

$I_F = f(V_F); T_S = 25\text{ °C}$

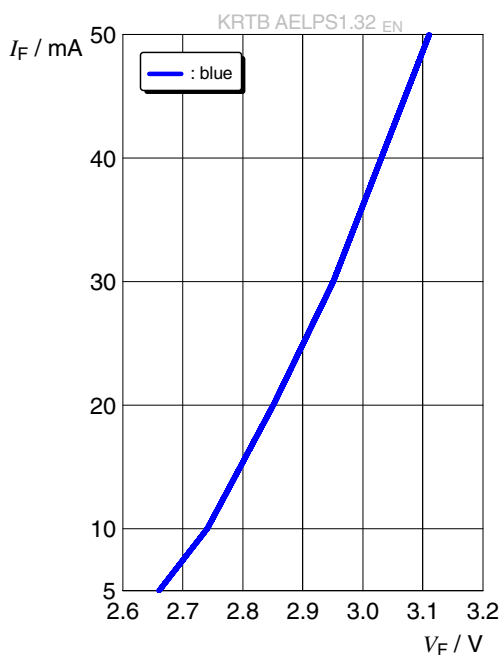

### Relative Luminous Intensity <sup>6)</sup>

$$I_V/I_V(20\text{ mA}) = f(I_F); T_s = 25\text{ }^\circ\text{C}$$

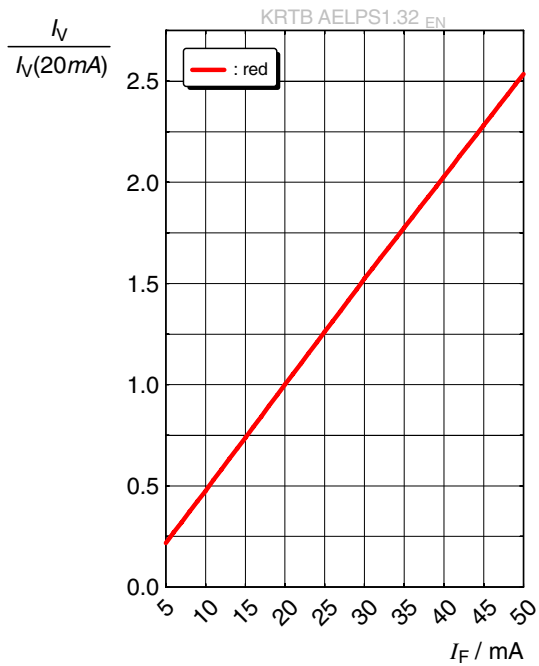

### Relative Luminous Intensity <sup>6)</sup>

$$I_V/I_V(20\text{ mA}) = f(I_F); T_s = 25\text{ }^\circ\text{C}$$

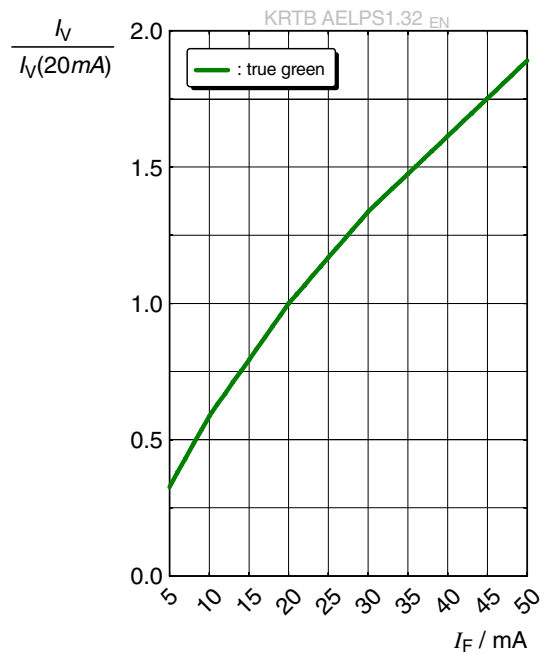

### Relative Luminous Intensity <sup>6)</sup>

$$I_V/I_V(20\text{ mA}) = f(I_F); T_s = 25\text{ }^\circ\text{C}$$

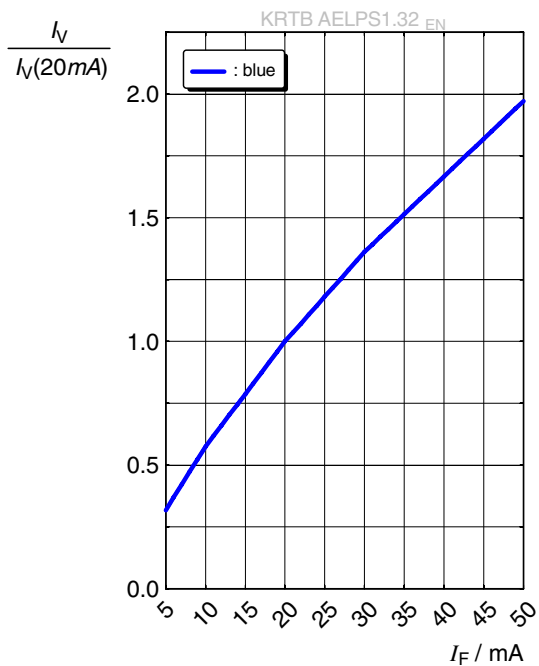



### Dominant Wavelength <sup>6)</sup>

$$\Delta\lambda_{\text{dom}} = f(I_F); T_S = 25\text{ °C}$$

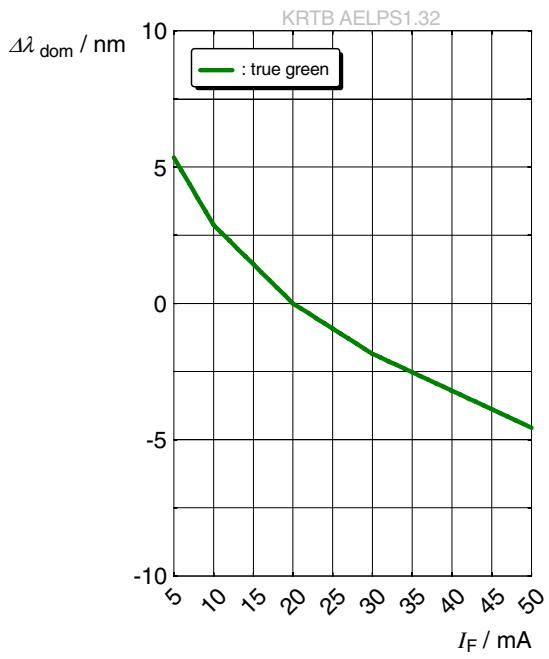

### Dominant Wavelength <sup>6)</sup>

$$\Delta\lambda_{\text{dom}} = f(I_F); T_S = 25\text{ °C}$$

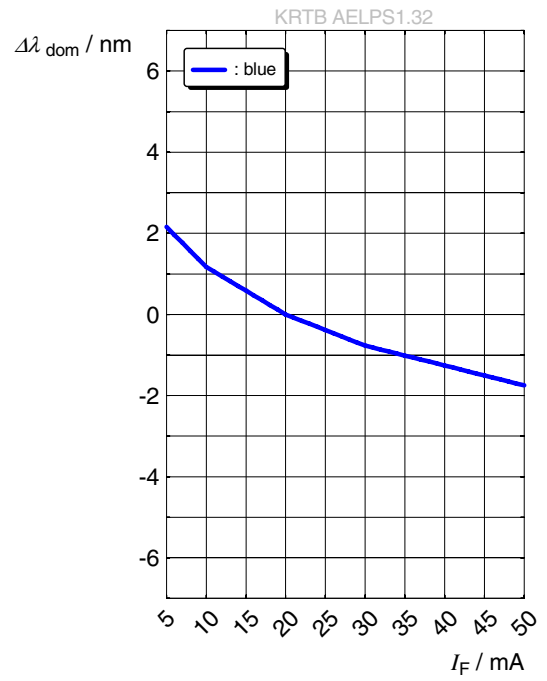

### Forward Voltage <sup>6)</sup>

$$\Delta V_F = V_F - V_F(25\text{ °C}) = f(T_j); I_F = 20\text{ mA}$$

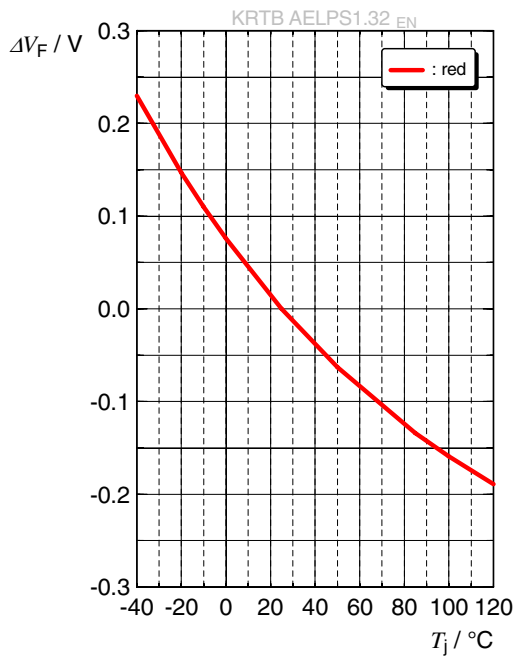

### Forward Voltage <sup>6)</sup>

$$\Delta V_F = V_F - V_F(25\text{ °C}) = f(T_j); I_F = 20\text{ mA}$$

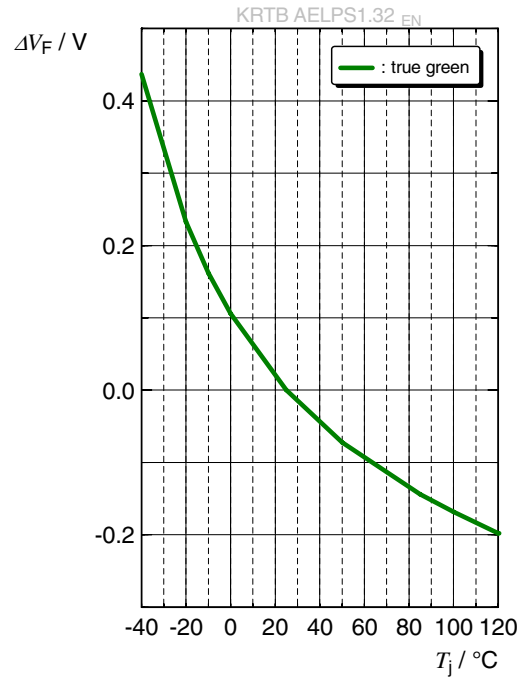

### Forward Voltage <sup>6)</sup>

$$\Delta V_F = V_F - V_F(25\text{ °C}) = f(T_j); I_F = 20\text{ mA}$$

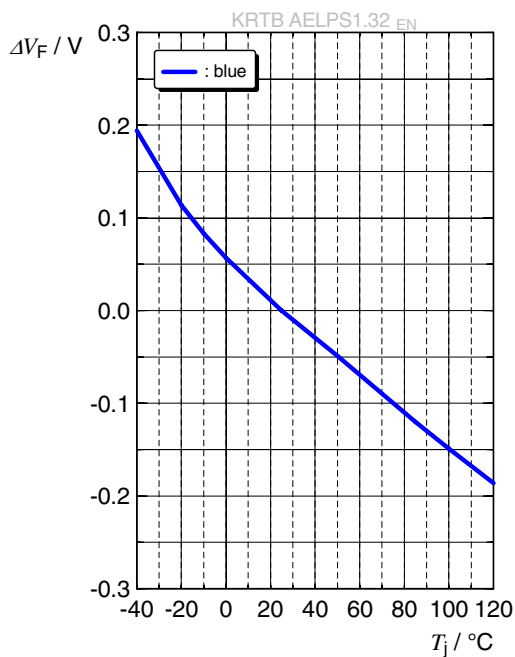

### Relative Luminous Intensity <sup>6)</sup>

$$I_v/I_v(25\text{ °C}) = f(T_j); I_F = 20\text{ mA}$$

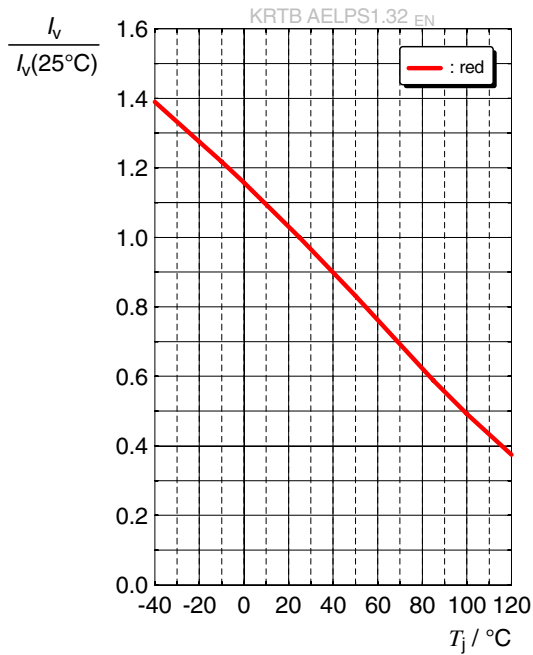

### Relative Luminous Intensity <sup>6)</sup>

$$I_v/I_v(25\text{ °C}) = f(T_j); I_F = 20\text{ mA}$$

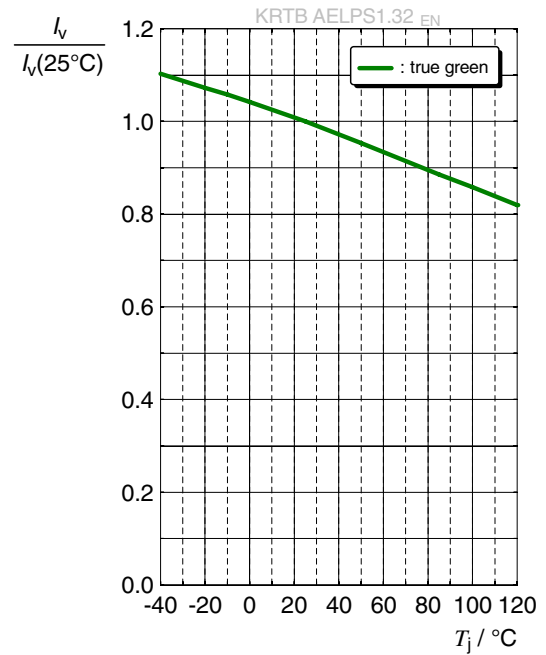

### Relative Luminous Intensity <sup>6)</sup>

$$I_v/I_v(25\text{ °C}) = f(T_j); I_F = 20\text{ mA}$$

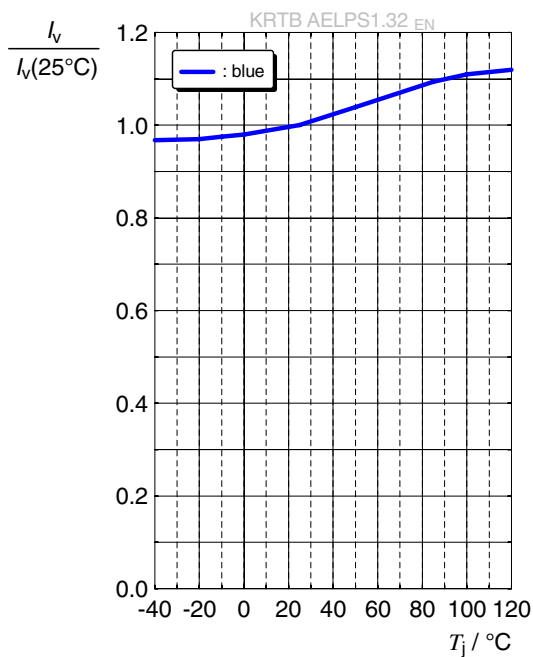

**Dominant Wavelength** <sup>6)</sup>

$$\Delta\lambda_{\text{dom}} = \lambda_{\text{dom}} - \lambda_{\text{dom}}(25\text{ °C}) = f(T_j); I_F = 20\text{ mA}$$

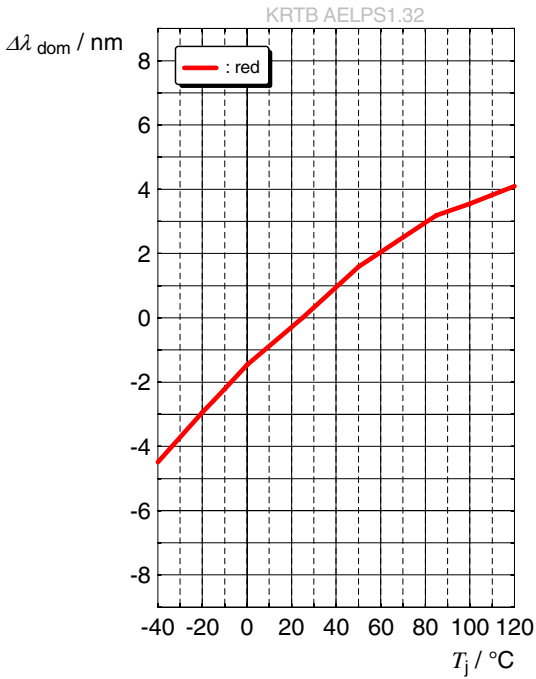

**Dominant Wavelength** <sup>6)</sup>

$$\Delta\lambda_{\text{dom}} = \lambda_{\text{dom}} - \lambda_{\text{dom}}(25\text{ °C}) = f(T_j); I_F = 20\text{ mA}$$

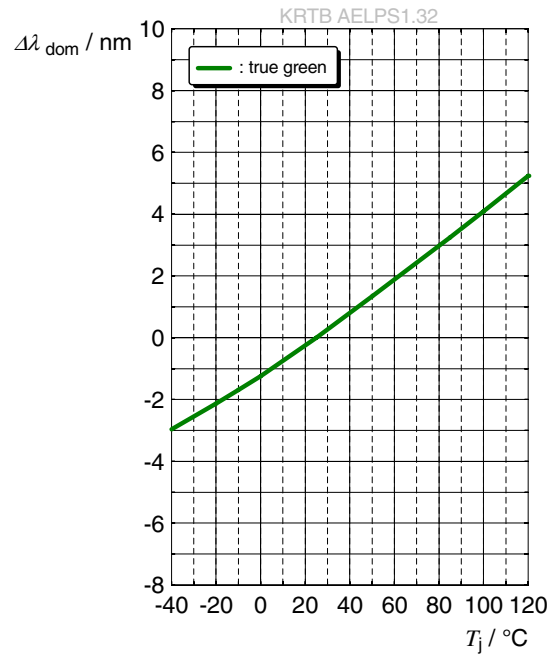

**Dominant Wavelength** <sup>6)</sup>

$$\Delta\lambda_{\text{dom}} = \lambda_{\text{dom}} - \lambda_{\text{dom}}(25\text{ °C}) = f(T_j); I_F = 20\text{ mA}$$

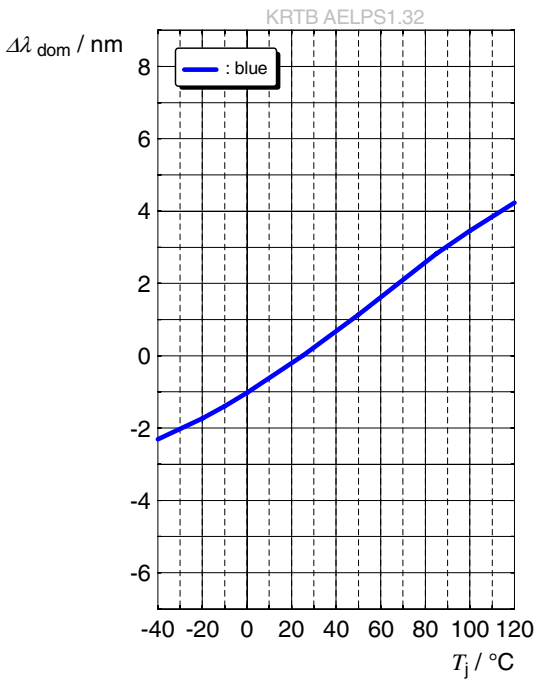

### Max. Permissible Forward Current

$I_F = f(T)$ ; ● red

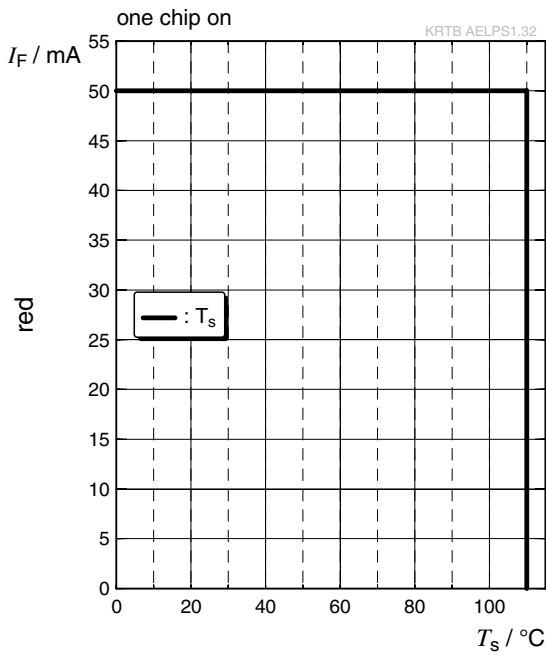

### Max. Permissible Forward Current

$I_F = f(T)$ ; ● true green

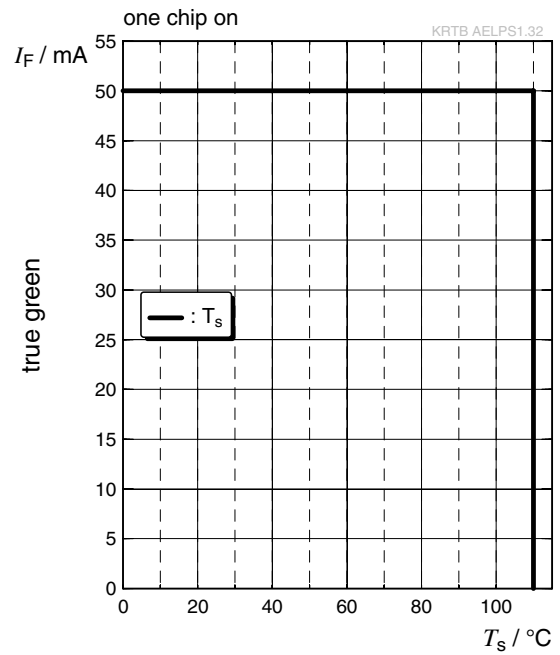

### Max. Permissible Forward Current

$I_F = f(T)$ ; ● blue

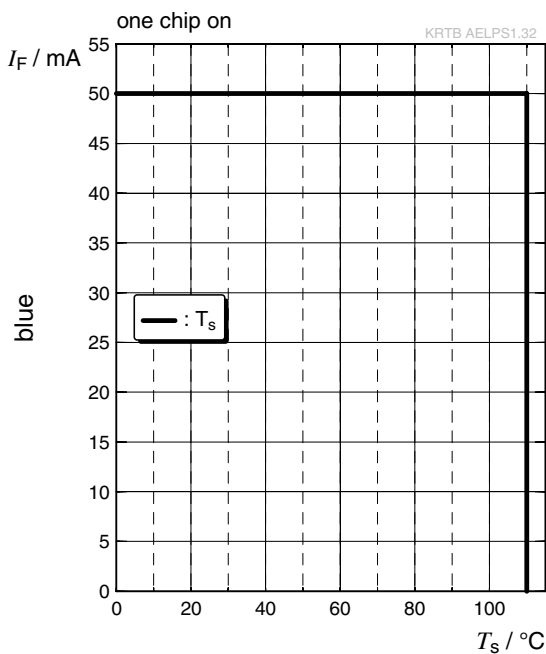

Permissible Pulse Handling Capability

$I_F = f(t_p)$ ; D: Duty cycle;  $T_S = 25\text{ °C}$ ; ● red

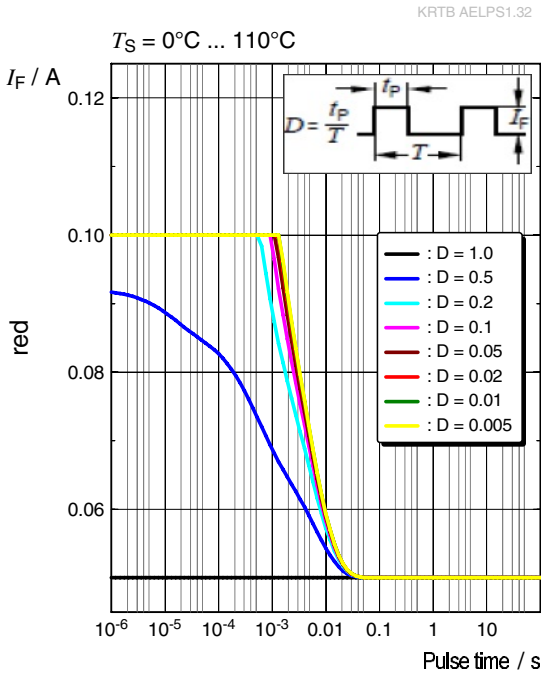

Permissible Pulse Handling Capability

$I_F = f(t_p)$ ; D: Duty cycle;  $T_S = 25\text{ °C}$ ; ● true green

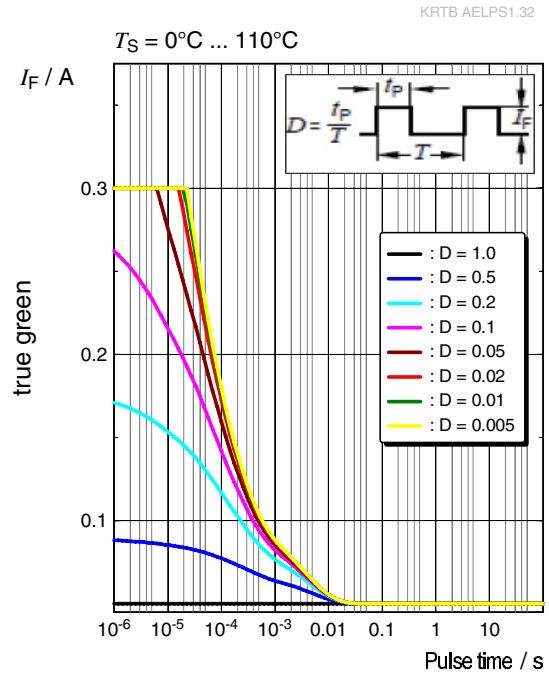

Permissible Pulse Handling Capability

$I_F = f(t_p)$ ; D: Duty cycle;  $T_S = 25\text{ °C}$ ; ● blue

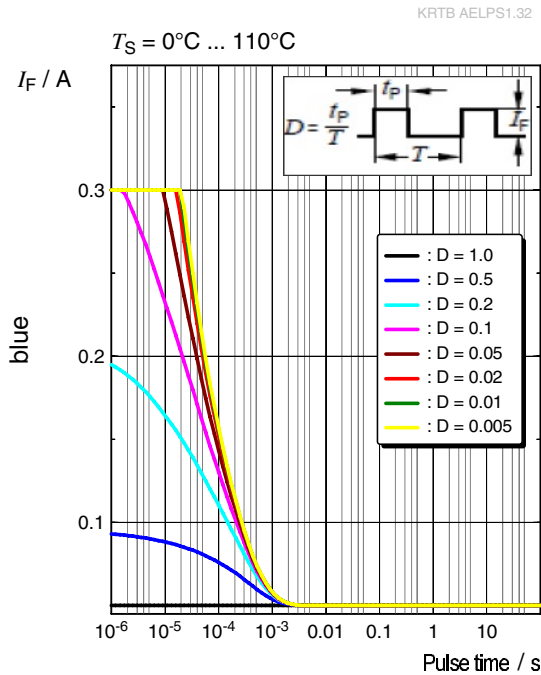

## Dimensional Drawing <sup>7)</sup>

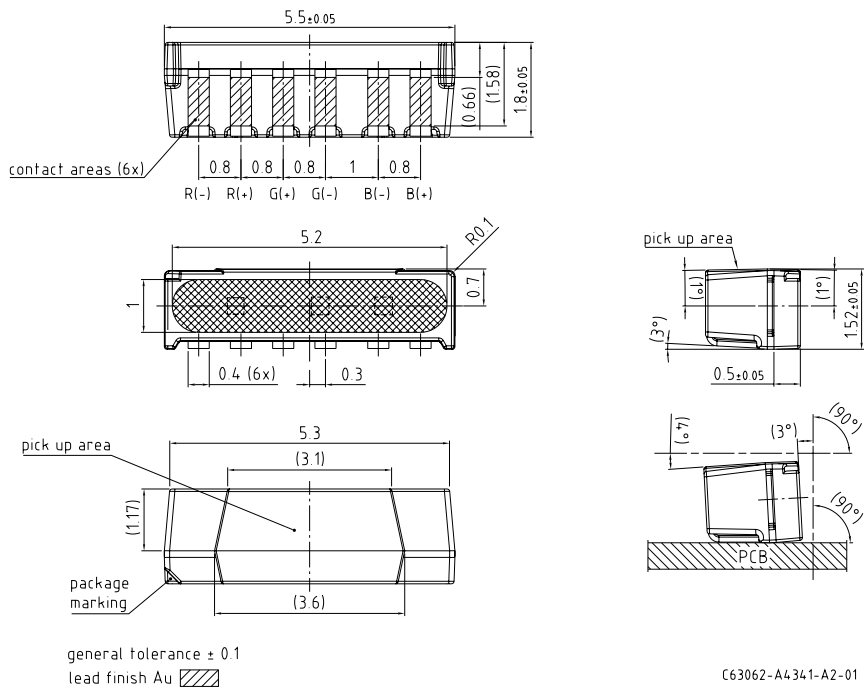

## Further Information:

**Approximate Weight:** 26.0 mg

**Corrosion test:** Class: 3B  
Test condition:  $40^\circ\text{C}$  / 90 % RH / 15 ppm  $\text{H}_2\text{S}$  / 14 days (stricter than IEC 60068-2-43)

Electrical Internal Circuit

Circuit diagram

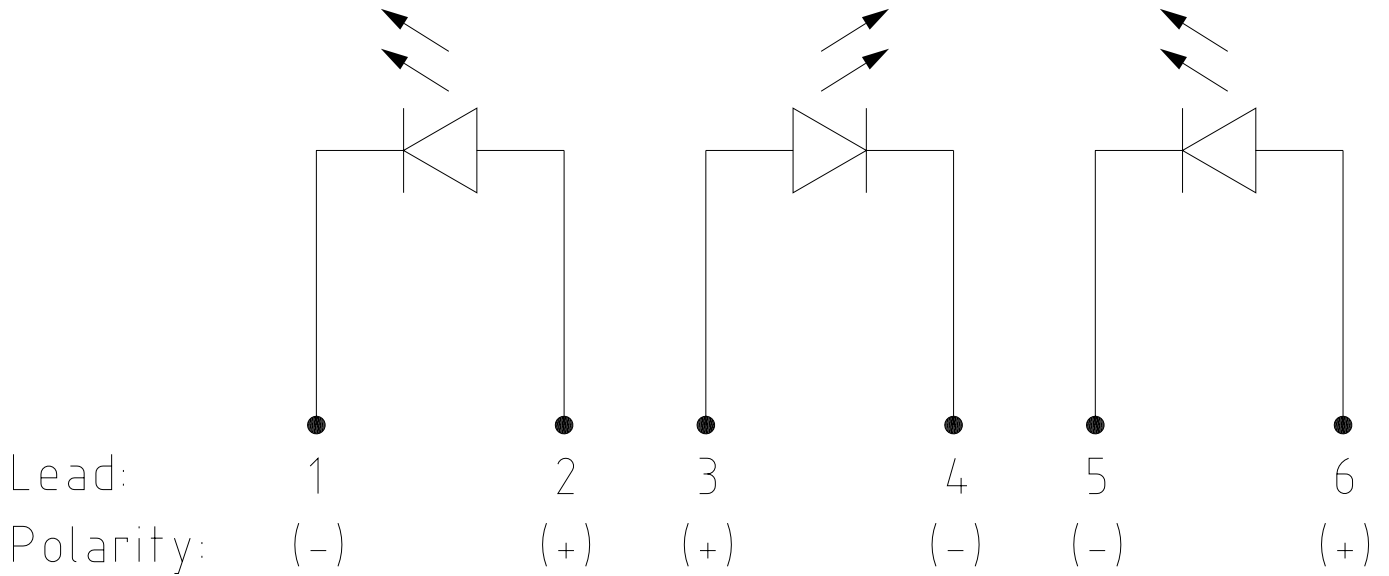



## Recommended Solder Pad <sup>7)</sup>

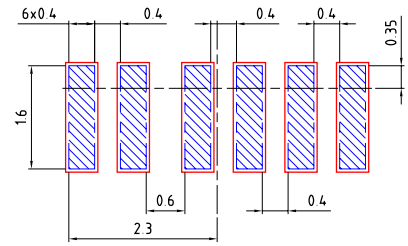
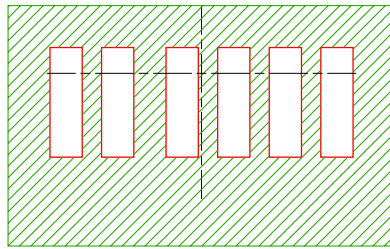
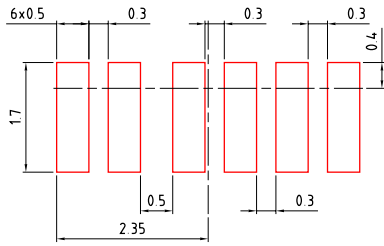

□ foot print

▨ solder resist

▨ solder stencil  
recommended stencil  
thickness 120µm

Component Location on Pad

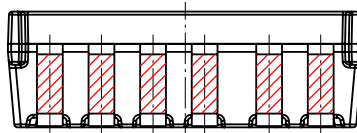
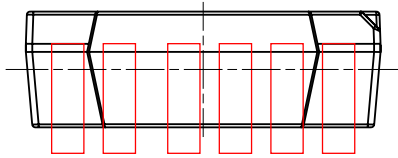

E062.3010.242 -01

For superior solder joint connectivity results we recommend soldering under standard nitrogen atmosphere. Package not suitable for any kind of wet cleaning or ultrasonic cleaning.

## Reflow Soldering Profile

Product complies to MSL Level 2 acc. to JEDEC J-STD-020E

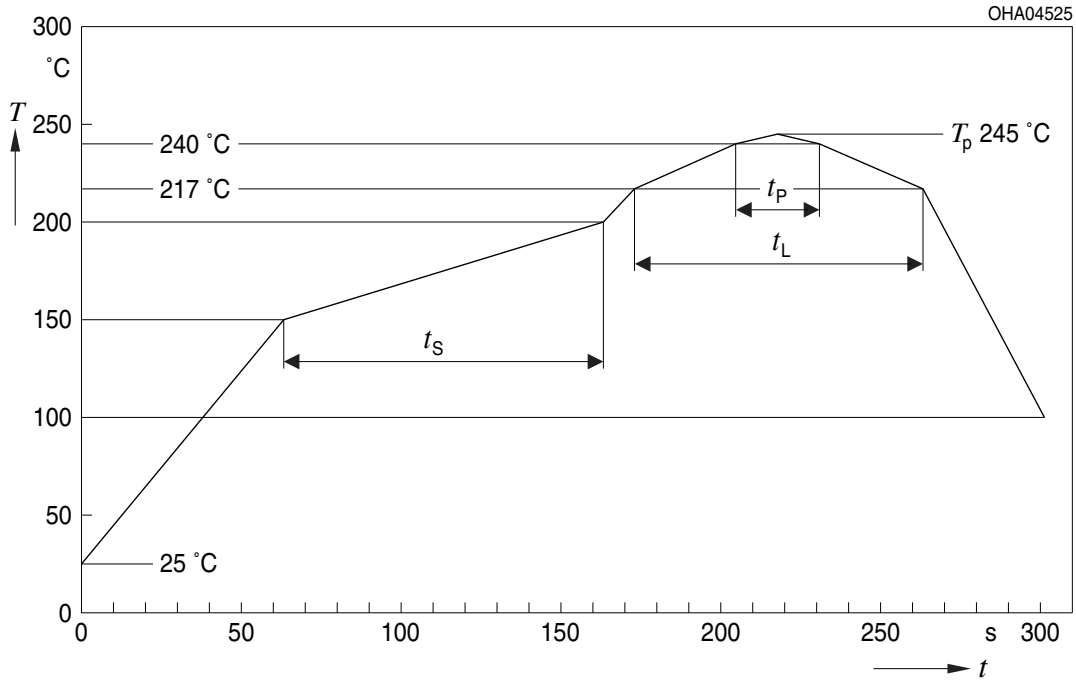

Profile Feature	Symbol	Pb-Free (SnAgCu) Assembly			Unit
		Minimum	Recommendation	Maximum	
Ramp-up rate to preheat <sup>*)</sup> 25 °C to 150 °C			2	3	K/s
Time $t_s$ $T_{Smin}$ to $T_{Smax}$	$t_s$	60	100	120	s
Ramp-up rate to peak <sup>*)</sup> $T_{Smax}$ to $T_p$			2	3	K/s
Liquidus temperature	$T_L$		217		°C
Time above liquidus temperature	$t_L$		80	100	s
Peak temperature	$T_p$		245	260	°C
Time within 5 °C of the specified peak temperature $T_p - 5$ K	$t_p$	10	20	30	s
Ramp-down rate* $T_p$ to 100 °C			3	6	K/s
Time 25 °C to $T_p$				480	s

All temperatures refer to the center of the package, measured on the top of the component  
<sup>\*</sup> slope calculation  $DT/Dt$ :  $Dt$  max. 5 s; fulfillment for the whole T-range

Taping <sup>7)</sup>

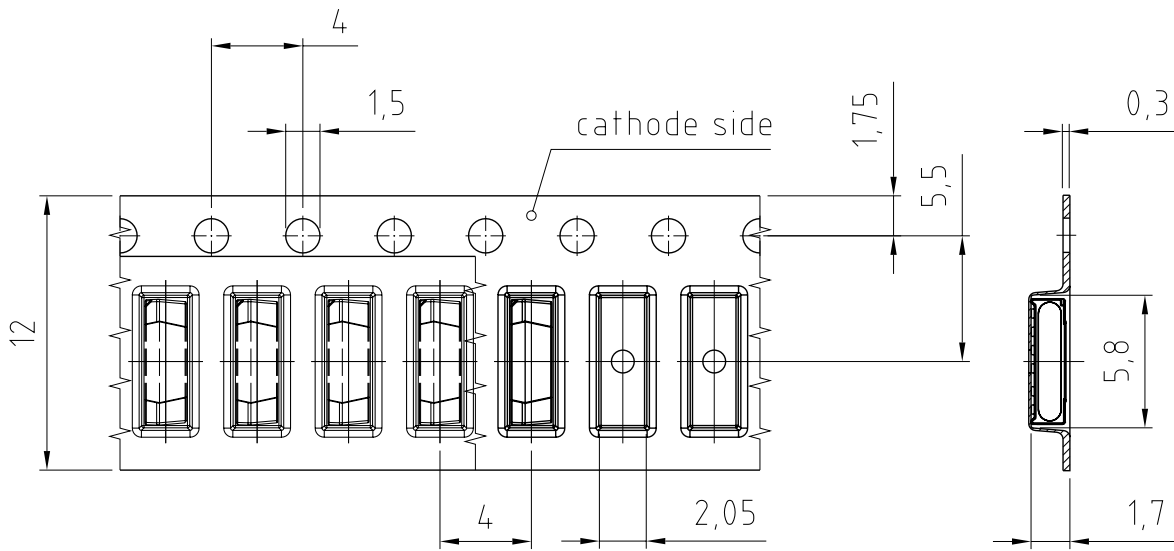

C63062-A4341-B15-02

**Tape and Reel** <sup>8)</sup>

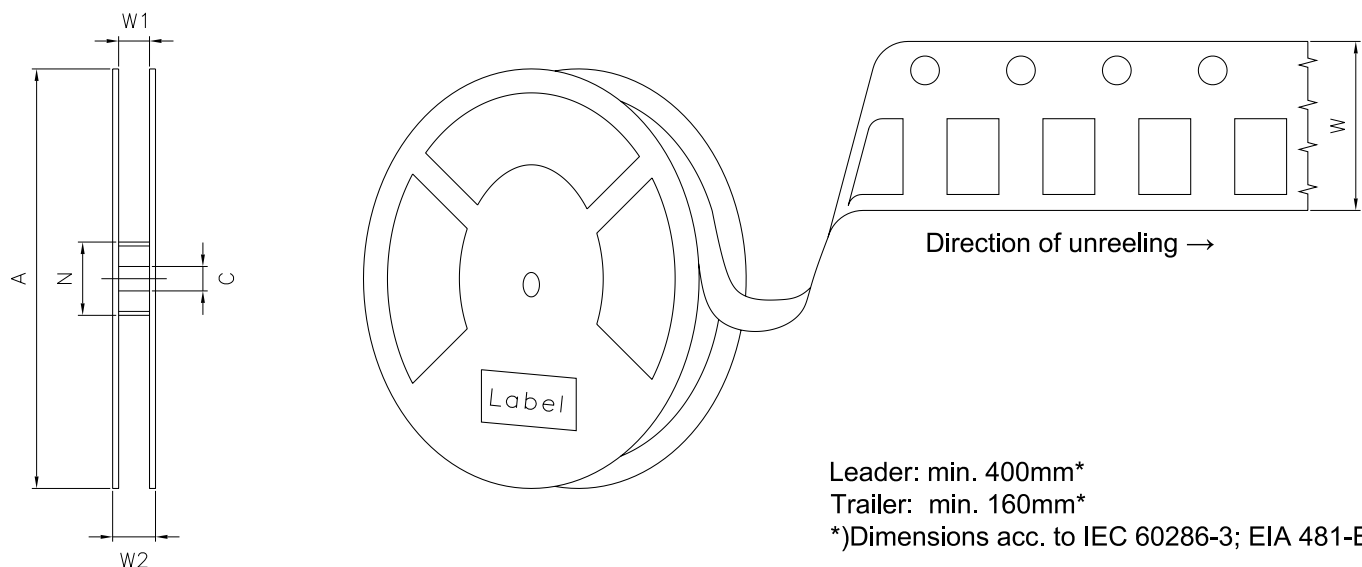

**Reel Dimensions**

A	W	N <sub>min</sub>	W <sub>1</sub>	W <sub>2max</sub>	Pieces per PU
180 mm	12 + 0.3 / - 0.1 mm	60 mm	12.4 + 2 mm	18.4 mm	2000

### Barcode-Product-Label (BPL)

**OSRAM Opto Semiconductors** LX XXXX BIN1: XX-XX-X-XXX-X

RoHS Compliant

(6P) BATCH NO: 1234567890

(1T) LOT NO: 1234567890 (9D) D/C: 1234

(X) PROD NO: 123456789(Q)QTY: 9999 (G) GROUP: XX-XX-X-X

ML Temp ST  
X XXX °C X

Pack: RXX  
DEMY XXX  
X\_X123\_1234.1234 X

OHA04563

### Dry Packing Process and Materials <sup>7)</sup>

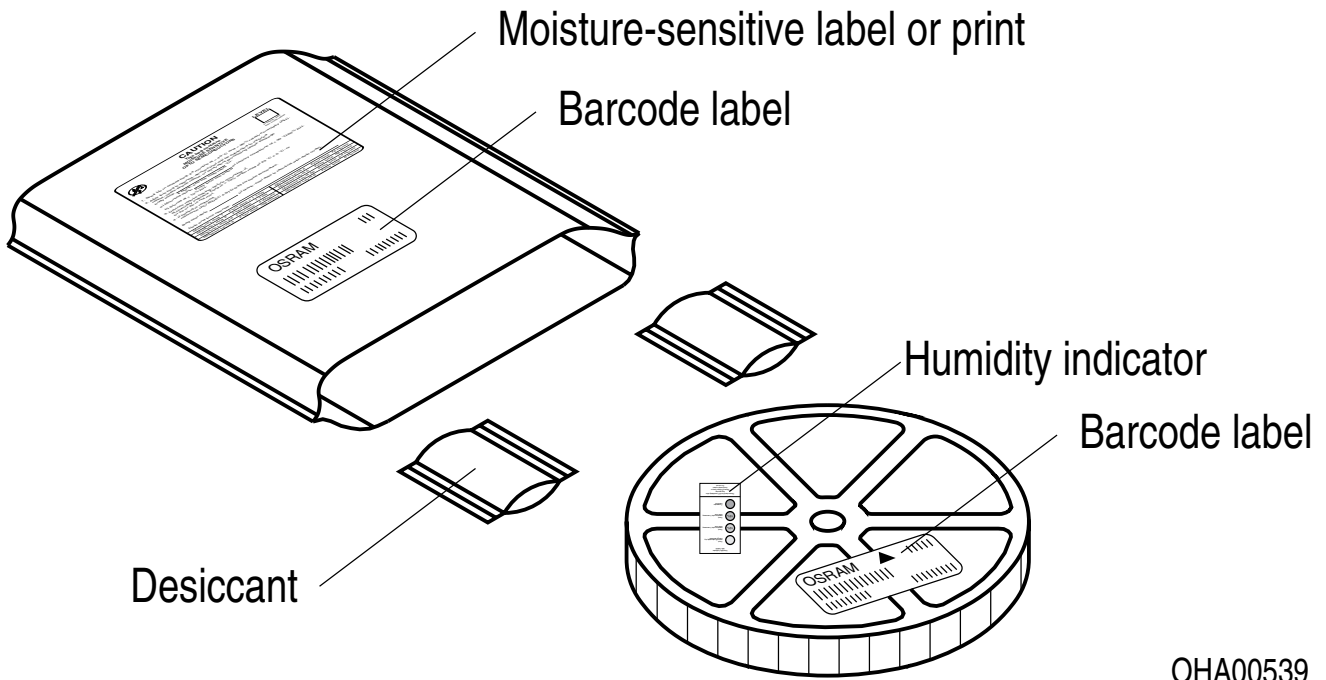

OHA00539

Moisture-sensitive product is packed in a dry bag containing desiccant and a humidity card according JEDEC-STD-033.

---

## Notes

The evaluation of eye safety occurs according to the standard IEC 62471:2006 (photo biological safety of lamps and lamp systems). Within the risk grouping system of this IEC standard, the device specified in this data sheet fall into the class **exempt group (exposure time 10000 s)**. Under real circumstances (for exposure time, conditions of the eye pupils, observation distance), it is assumed that no endangerment to the eye exists from these devices. As a matter of principle, however, it should be mentioned that intense light sources have a high secondary exposure potential due to their blinding effect. When looking at bright light sources (e.g. headlights), temporary reduction in visual acuity and afterimages can occur, leading to irritation, annoyance, visual impairment, and even accidents, depending on the situation.

Subcomponents of this device contain, in addition to other substances, metal filled materials including silver. Metal filled materials can be affected by environments that contain traces of aggressive substances. Therefore, we recommend that customers minimize device exposure to aggressive substances during storage, production, and use. Devices that showed visible discoloration when tested using the described tests above did show no performance deviations within failure limits during the stated test duration. Respective failure limits are described in the IEC60810.

For further application related information please visit [www.osram-os.com/appnotes](http://www.osram-os.com/appnotes)

## Disclaimer

### Attention please!

The information describes the type of component and shall not be considered as assured characteristics. Terms of delivery and rights to change design reserved. Due to technical requirements components may contain dangerous substances.

For information on the types in question please contact our Sales Organization.

If printed or downloaded, please find the latest version on our website.

### Packing

Please use the recycling operators known to you. We can also help you – get in touch with your nearest sales office. By agreement we will take packing material back, if it is sorted. You must bear the costs of transport. For packing material that is returned to us unsorted or which we are not obliged to accept, we shall have to invoice you for any costs incurred.

### Product and functional safety devices/applications or medical devices/applications

Our components are not developed, constructed or tested for the application as safety relevant component or for the application in medical devices.

Our products are not qualified at module and system level for such application.

In case buyer – or customer supplied by buyer – considers using our components in product safety devices/ applications or medical devices/applications, buyer and/or customer has to inform our local sales partner immediately and we and buyer and /or customer will analyze and coordinate the customer-specific request between us and buyer and/or customer.

---

## Glossary

- 1) **Brightness:** Brightness values are measured during a current pulse of typically 25 ms, with an internal reproducibility of  $\pm 8\%$  and an expanded uncertainty of  $\pm 11\%$  (acc. to GUM with a coverage factor of  $k = 3$ ).
- 2) **Reverse Operation:** This product is intended to be operated applying a forward current within the specified range. Applying any continuous reverse bias or forward bias below the voltage range of light emission shall be avoided because it may cause migration which can change the electro-optical characteristics or damage the LED.
- 3) **Wavelength:** The wavelength is measured at a current pulse of typically 25 ms, with an internal reproducibility of  $\pm 0.5$  nm and an expanded uncertainty of  $\pm 1$  nm (acc. to GUM with a coverage factor of  $k = 3$ ).
- 4) **Forward Voltage:** Forward voltages are tested at a current pulse duration of 1 ms and a tolerance of  $\pm 0.05$  V and an expanded uncertainty of  $\pm 0.1$  V (acc. to GUM with a coverage factor of  $k = 3$ ).
- 5) **Thermal Resistance:**  $R_{th\ max}$  is based on statistic values ( $6\sigma$ ).
- 6) **Typical Values:** Due to the special conditions of the manufacturing processes of semiconductor devices, the typical data or calculated correlations of technical parameters can only reflect statistical figures. These do not necessarily correspond to the actual parameters of each single product, which could differ from the typical data and calculated correlations or the typical characteristic line. If requested, e.g. because of technical improvements, these typ. data will be changed without any further notice.
- 7) **Tolerance of Measure:** Unless otherwise noted in drawing, tolerances are specified with  $\pm 0.1$  and dimensions are specified in mm.
- 8) **Tape and Reel:** All dimensions and tolerances are specified acc. IEC 60286-3 and specified in mm.



---

## Revision History

Version	Date	Change
1.0	2019-11-20	Initial Version
1.1	2021-01-18	Features Schematic Transportation Box Dimensions of Transportation Box Glossary
1.2	2021-05-20	Characteristics
1.3	2022-09-21	New Layout Applications Chromaticity Coordinate Groups

---



EU RoHS and China RoHS compliant product

此产品符合欧盟 RoHS 指令的要求；  
按照中国的相关法规和标准，  
不含有毒有害物质或元素。

**Published by ams-OSRAM AG**

Tobelbader Strasse 30, 8141 Premstaetten, Austria

Phone +43 3136 500-0

[ams-osram.com](http://ams-osram.com)

© All rights reserved

**am** 

**OSRAM**