

Overview

KO-CAP Polymer Capacitors

The KEMET Organic Capacitors (KO-CAP) are preferred solutions for applications requiring power loss protection (hold-up) or maximum power efficiency of a circuit when board space is limited. Desired benefits include high energy density, stable capacitance with applied voltage and temperature, and no aging effects. The conductive polymer cathode of these solid electrolytic capacitors

provide very low ESR and higher capacitance retention at high frequencies. Unlike liquid electrolyte-based capacitors, KEMET polymer capacitors have a very long operational life and high ripple current capabilities. Capacitors from T520, T521, and T523 series are commonly used in these applications. The T545 and T548 were introduced to meet specific needs for a subsegment of solid state drives.

Benefits

- Highest energy per unit volume
- Stable capacitance across temperature and voltage
- No aging effects
- Low ESR values
- High frequency capacitance retention
- High ripple handling
- 100% accelerated steady state aging
- 100% surge current tested
- Halogen-free epoxy and RoHS compliant

Applications

Typical applications include enterprise storage, networking, server, mobile, client storage, and client computing.

T520 / T521 / T545



T523 / T548

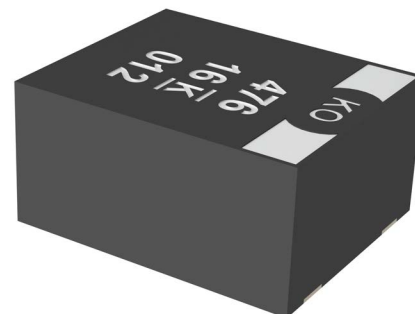

Environmental Compliance

- RoHS compliant when ordered with 100% Sn solder or Ni-Pd-Au
- Halogen-free
- Epoxy compliant with UL94 V-0

K-SIM

For a detailed analysis of specific part numbers, please visit ksim.kemet.com to access KEMET's K-SIM software. KEMET K-SIM is designed to simulate behavior of components with respect to frequency, ambient temperature, and DC bias levels.

Ordering Information

T	548	V	157	M	016	A	T	E050	
Capacitor Class	Series	Case Size	Capacitance Code (pF)	Capacitance Tolerance	Rated Voltage (VDC)	Failure Rate/Design	Termination Finish	ESR	Packaging (C-Spec)
T = Tantalum	520 = Low voltage 521 = High voltage 523 = Facedown terminal 545 = High energy 548 = High energy, facedown terminal	B, G, H, J, M, O, T, V, W, X, Y	First two digits represent significant figures. Third digit specifies number of zeros.	K = ±10% M = ±20%	006 = 6.3 010 = 10 016 = 16 020 = 20 025 = 25 035 = 35	A = N/A	T = 100% matte tin (Sn)-plated P* = Ni-Pd-Au-plated	ESR in mΩ	Blank = 7" reel 7280 = 13" reel

* P termination only available on T523/T548 part numbers

Performance Characteristics

Item	Performance Characteristics
Operating Temperature	-55°C to 85°C/125°C (refer to part number in Table 1 for maximum temperature rating)
Rated Capacitance Range	22 – 1,500 µF at 120 Hz/25°C
Capacitance Tolerance	K tolerance (10%), M tolerance (20%)
Rated Voltage Range	6.3 – 35 VDC
DF (120 Hz)	Refer to part number in Table 1 for electrical specification
ESR (100 kHz)	Refer to part number in Table 1 for electrical specification
Leakage Current	≤ 0.1 CV (µA) at rated voltage after 5 minutes (refer to part number in Table 1 for electrical specification)

Qualification

Test	Condition	Characteristics						
Endurance	85°C or 105°C at rated voltage, 2,000 hours** 125°C at 2/3 rated voltage, 2,000 hours **	Δ C/C	Within -20/+10% of initial value					
		DF	Within initial limit Within 2.0 x initial limit *1					
		DCL	Within 1.25 x initial limit Within 2.0 x initial limit *1					
		ESR	Within 2.0 x initial limit					
Storage Life	85°C/105°C/125°C at 0 volts, 2,000 hours**	Δ C/C	Within -20%/+10% of initial value					
		DF	Within initial limit Within 2.0 x initial limit *1					
		DCL	Within 1.25 x initial limit Within 2.0 x initial limit *1					
		ESR	Within 2.0 x initial limit					
Humidity	60°C, 90% RH, no load, 500 hours	Δ C/C	Within -5% /+35%					
		DF	Within initial limit					
		DCL	Within 5.0 x initial limit					
		ESR	Within 2.0 x initial limit					
Temperature Stability	Extreme temperature exposure at a succession of continuous steps at +25°C, -55°C, +25°C, +85°C, +105°C**, +25°C	+25°C	-55°C	+25°C	+85°C	+105°C**	+25°C	
		Δ C/C	IL*	±20%	±10%	±20%	±30%	±10%
		DF	IL	IL	IL	1.2 x IL	1.5 x IL	IL
Surge Voltage	85°C/105°C/125°C, 1.32 x rated voltage*2, 1,000 cycles **	Δ C/C	Within -20/+10% of initial value					
		DF	Within initial limits					
		DCL	Within initial limits					
		ESR	Within initial limits					
Mechanical Shock/ Vibration	MIL-STD-202, Method 213 and 204 Condition I, 100 G peak Condition D, 20 G for 20 minutes/12 cycles each of 3 orientations. Test from 10 ~ 2,000 Hz	Δ C/C	Within ±10% of initial value (Within initial limits for T527 Series)					
		DF	Within initial limits					
		DCL	Within initial limits					

* IL = Initial limit

** Refer to Table 1 - Ratings & Part Number Reference for temperature classification. If temperature classification is 85°C, the 105°C step is not performed for the temperature stability test.

*1 For 125°C rated part numbers

*2 For PN T523W476M035AP/T523V686M035AP test voltage is 1.15 x V_R

Reliability

KO-CAP capacitors have an average failure rate of 0.5 %/1,000 hours at category voltage, U_C , and category temperature, T_C . These capacitors are qualified using industry test standards at U_C and T_C . The minimum test time (1,000 hours or 2,000 hours) is dependent on the product.

The actual life expectancy of KO-CAP capacitors increases when application voltage, U_A , and application temperature, T_A , are lower than U_C and T_C . As a general guideline, when $U_A < 0.9 * U_C$ and $T_A < 85^\circ\text{C}$, the life expectancy will typically exceed the useful lifetime of most hardware (> 10 years).

The lifetime of a KO-CAP capacitor at a specific application voltage and temperature can be modeled using the equations below. A failure is defined as passing enough current to blow a 1-amp fuse. The calculation is an estimation based on empirical results and is not a guarantee.

$$VAF = \left(\frac{U_C}{U_A}\right)^n$$

where:
 VAF = acceleration factor due to voltage, unitless
 U_C = category voltage, volt
 U_A = application voltage, volt
 n = exponent, 16

$$TAF = e^{\left[\frac{E_a}{k} \left(\frac{1}{273+T_A} - \frac{1}{273+T_C}\right)\right]}$$

where:
 TAF = acceleration factor due to temperature, unitless
 E_a = activation energy, 1.4 eV
 k = Boltzmann's constant, 8.617E-5 eV/K
 T_A = application temperature, °C
 T_C = category temperature, °C

$$AF = VAF * TAF$$

where:
 AF = acceleration factor, unitless
 TAF = acceleration factor due to temperature, unitless
 VAF = acceleration factor due to voltage, unitless

$$Life_{U_A, T_A} = Life_{U_C, T_C} * AF$$

where:
 $Life_{U_A, T_A}$ = estimated life application voltage and temperature, years
 $Life_{U_C, T_C}$ = guaranteed life category voltage and temperature, years
 AF = acceleration factor, unitless

Terms:

Category voltage, U_C : maximum recommended peak DC operating voltage for continuous operation at the category temperature, T_C
 Rated voltage, U_R : maximum recommended peak DC operating voltage for continuous operation up to the rated temperature, T_R
 Category temperature, T_C : maximum recommended operating temperature. Voltage derating may be required at T_C
 Rated temperature, T_R : maximum recommended operating temperature without voltage derating. T_R is equal to or lower than T_C

Reliability Table 1 – Common temperature range classifications														
85°C (T_R) / 85°C (T_C)	Rated Voltage (U_R)	2.5	4.0	6.3	8.0	10.0	12.5	16.0	20.0	25.0	35.0	50.0	63.0	75.0
	Category Voltage (U_C)	2.5	4.0	6.3	8.0	10.0	12.5	16.0	20.0	25.0	35.0	50.0	63.0	75.0
105°C (T_R) / 105°C (T_C)	Rated Voltage (U_R)	2.5	4.0	6.3	8.0	10.0	12.5	16.0	20.0	25.0	35.0	50.0	63.0	75.0
	Category Voltage (U_C)	2.5	4.0	6.3	8.0	10.0	12.5	16.0	20.0	25.0	35.0	50.0	63.0	75.0
105°C (T_R) / 125°C (T_C)	Rated Voltage (U_R)	2.5	4.0	6.3	8.0	10.0	12.5	16.0	20.0	25.0	35.0	50.0	63.0	75.0
	Category Voltage (U_C)	1.7	2.7	4.2	5.4	6.7	8.4	10.7	13.4	16.8	23.5	33.5	42.2	50.3

Dimensions – Millimeters (Inches)

Metric will govern

For T520 / T521 / T545

CATHODE (-) END VIEW

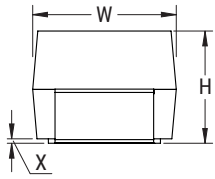

SIDE VIEW

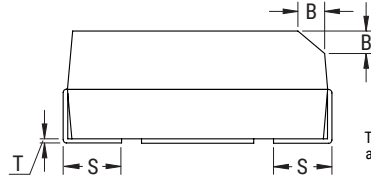

ANODE (+) END VIEW

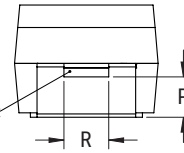

BOTTOM VIEW

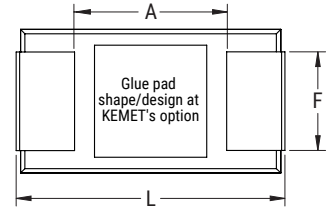

Termination cutout at KEMET's option, either end

KEMET	EIA	L	W	H	F ±0.1 (±0.004)	S ±0.3 (±0.012)	B ±0.15 (Ref) ±0.006	X (Ref)	P (Ref)	R (Ref)	T (Ref)	A (Min)	Typical Weight (mg)
T	3528-12	3.5 ±0.2 (0.138 ±0.008)	2.8 ±0.2 (0.110 ±0.008)	1.1 ±0.1 (0.043 ±0.004)	2.2 (0.087)	0.80 (0.032)	N/A	0.05 (0.002)	N/A	N/A	0.13 (0.005)	1.9 (0.075)	55
M	3528-15	3.5 ±0.2 (0.138 ±0.008)	2.8 ±0.2 (0.110 ±0.008)	1.4 ±0.1 (0.055 ±0.004)	2.2 (0.087)	0.8 (0.031)	N/A	0.05 (0.002)	N/A	N/A	0.13 (0.005)	1.1 (0.043)	98
B	3528-21	3.5 ±0.2 (0.138 ±0.008)	2.8 ±0.2 (0.110 ±0.008)	1.9 ±0.2 (0.075 ±0.008)	2.2 (0.087)	0.80 (0.032)	0.4 (0.016)	0.10 ±0.10 (0.004 ±0.004)	0.5 (0.020)	1.0 (0.039)	0.13 (0.005)	1.9 (0.075)	95
W	7343-15	7.3 ±0.3 (0.287 ±0.012)	4.3 ±0.3 (0.169 ±0.012)	1.4 ±0.1 (0.055 ±0.004)	2.4 (0.094)	1.30 (0.051)	N/A	0.05 (0.002)	N/A	N/A	0.13 (0.005)	3.8 (0.150)	223
V	7343-20	7.3 ±0.3 (0.287 ±0.012)	4.3 ±0.3 (0.169 ±0.012)	1.9 ±0.1 (0.075 ±0.004)	2.4 (0.094)	1.30 (0.051)	N/A	0.05 (0.002)	N/A	N/A	0.13 (0.005)	3.8 (0.150)	274
Y	7343-40	7.3 ±0.3 (0.287 ±0.012)	4.3 ±0.3 (0.169 ±0.012)	3.8 ±0.2 (0.150 ±0.008)	2.4 (0.094)	1.3 (0.051)	0.5 (0.020)	0.10 ±0.10 (0.004 ±0.004)	1.7 (0.067)	1.0 (0.039)	0.13 (0.005)	3.8 (0.150)	494
X	7343-43	7.3 ±0.3 (0.287 ±0.012)	4.3 ±0.3 (0.169 ±0.012)	4.0 ±0.3 (0.157 ±0.012)	2.4 (0.094)	1.30 (0.051)	0.5 (0.020)	0.10 ±0.10 (0.004 ±0.004)	1.7 (0.067)	1.0 (0.039)	0.13 (0.005)	3.8 (0.150)	554
J	7360-15	7.3 ±0.3 (0.287 ±0.012)	6.0 ±0.3 (0.236 ±0.012)	1.4 ±0.1 (0.055 ±0.004)	4.1 (0.161)	1.30 (0.051)	N/A	0.10 ±0.10 (0.004 ±0.004)	N/A	N/A	0.13 (0.005)	3.8 (0.150)	263
H	7360-20	7.3 ±0.3 (0.287 ±0.012)	6.0 ±0.3 (0.236 ±0.012)	1.9 ±0.1 (0.075 ±0.004)	4.1 (0.161)	1.3 (0.051)	N/A	0.10 ±0.10 (0.004 ±0.004)	N/A	N/A	0.13 (0.005)	3.8 (0.150)	385
O	7360-43	7.3 ±0.3 (0.287 ±0.012)	6.0 ±0.3 (0.236 ±0.012)	4.0 ±0.3 (0.157 ±0.012)	4.1 (0.161)	1.3 (0.051)	N/A	0.10 ±0.10 (0.004 ±0.004)	N/A	N/A	0.13 (0.005)	3.8 (0.150)	696

For T523 / T548

END VIEW

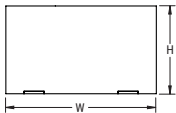

SIDE VIEW

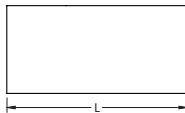

BOTTOM VIEW
H Case

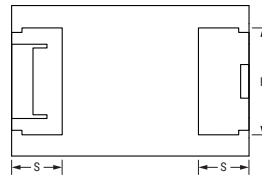

BOTTOM VIEW
V/W/J Case

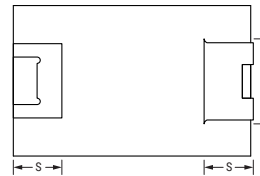

BOTTOM VIEW
T Case

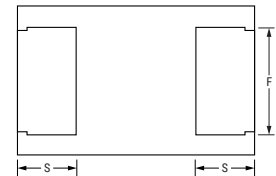

KEMET	EIA	L	W	H	F ±0.1 (±0.004)	S ±0.3 (±0.012)	Typical Weight (mg)
T	3528-12	3.5 ±0.2 (0.138 ±0.008)	2.8 ±0.2 (0.110 ±0.008)	1.1 ±0.1 (0.043 ±0.004)	2.2 (0.087)	0.80 (0.032)	55
W	7343-15	7.3 ±0.3 (0.287 ±0.012)	4.3 ±0.3 (0.169 ±0.012)	1.4 ±0.1 (0.055 ±0.004)	2.4 (0.094)	1.3 (0.051)	223
G	7360-12	7.3 ±0.3 (0.287 ±0.012)	6.0 ±0.3 (0.236 ±0.012)	1.2 ±0.1 (0.047 ±0.004)	4.45 (0.175)	1.6 (0.063)	-
J	7360-15	7.3 ±0.3 (0.287 ±0.012)	6.0 ±0.3 (0.236 ±0.012)	1.5 ±0.1 (0.059 ±0.004)	4.45 (0.175)	1.6 (0.063)	263
V	7343-20	7.3 ±0.3 (0.287 ±0.012)	4.3 ±0.3 (0.169 ±0.012)	1.9 ±0.1 (0.075 ±0.004)	2.4 (0.094)	1.3 (0.051)	274
H	7360-20	7.3 ±0.3 (0.287 ±0.012)	6.0 ±0.3 (0.236 ±0.012)	1.9 ±0.1 (0.075 ±0.004)	4.45 (0.175)	1.6 (0.063)	385

Table 1 – Ratings & Part Number Reference

Rated Voltage	Rated Capacitance	Case Code/ Case Size	KEMET Part Number	Energy	Maximum DC Leakage at 25°C, V _R , 5 min charge time	Maximum DF at 25°C, 120 Hz	Maximum ESR at 25°C, 100 kHz	Maximum Allowable RMS Ripple Current at 45°C, 100 kHz	MSL	Maximum Operating Temperature
VDC	µF	KEMET/ EIA		mJ	µA	%	mΩ	mA		°C
6.3	100	T/3528-12	T520T107M006APE070	1.2	63.0	10	70	1,230	3	105
6.3	150	T/3528-12	T520T157M006ATE070	1.7	94.5	10	70	1,230	3	105
6.3	150	M/3528-15	T520M157M006ATE070	1.7	94.5	10	70	1,310	3	105
6.3	220	B/3528-21	T520B227M006ATE070	2.5	138.6	10	70	1,350	3	105
6.3	330	V/7343-20	T545V337M006ATE045	3.8	207.9	10	45	2,040	3	105
6.3	470	W/7343-15	T545W477M006ATE035	5.4	296.1	10	35	2,270	3	105
6.3	470	W/7343-15	T545W477M006ATE045	5.4	296.1	10	45	2,000	3	105
6.3	470	W/7343-15	T545W477M006ATE055	5.4	296.1	10	55	1,810	3	105
6.3	470	V/7343-20	T545V477M006ATE055	5.4	296.1	10	55	1,850	3	105
6.3	680	V/7343-20	T520V687M006ATE025	7.9	428.4	10	25	3,100	3	105
6.3	680	V/7343-20	T520V687M006ATE035	7.9	428.4	10	35	2,300	3	105
6.3	680	X/7343-43	T520X687M006ATE025	7.9	428.4	10	25	3,150	3	105
6.3	680	J/7360-15	T523J687M006APE070	7.9	428.0	10	70	2,510	3	85
6.3	1,000	H/7360-20	T545H108M006ATE055	11.6	630.0	20	55	1,850	3	85
6.3	1,500	H/7360-20	T520H158M006ATE055	17.4	945.0	20	55	1,800	3	85
6.3	1,500	H/7360-20	T520H158M006ATE035	17.4	945.0	20	35	2,320	3	85
6.3	1,500	H/7360-20	T545H158M006ATE035	17.4	945.0	20	35	2,320	3	85
6.3	1,500	H/7360-20	T545H158M006ATE055	17.4	945.0	20	55	1,850	3	85
10	330	Y/7343-40	T545Y337M010ATE035	11.9	330.0	10	35	2,630	3	105
10	220	V/7343-20	T545V227M010ATE045	7.9	220.0	10	45	2,040	3	105
10	330	G/7360-12	T523G337M010APE150	11.0	330.0	10	150	1,410	4	85
10	330	J/7360-15	T523J337M010APE070	11.9	330.0	10	70	2,510	3	85
10	390	G/7360-12	T523G397M010APE150	14.0	390.0	10	150	1,410	4	85
10	470	J/7360-15	T523J477M010APE070	16.9	470.0	10	70	2,510	4	85
10	820	H/7360-20	T520H827M010ATE055	29.5	820.0	10	55	1,910	3	85
10	1,000	H/7360-20	T523H108M010APE070	36.0	1000.0	10	70	2,510	4	85
16	22	B/3528-21	T521B226M016ATE070	1.7	35.2	10	70	1,350	3	105
16	33	T/3528-12	T521T336M016ATE070	2.6	52.8	10	70	1,230	3	105
16	47	T/3528-12	T523T476M016APE090	3.6	75.2	10	90	1,080	4	85
16	47	W/7343-15	T545W476M016ATE045	3.6	75.2	10	45	2,000	3	105
16	47	V/7343-20	T545V476M016ATE045	3.6	75.2	10	45	2,040	3	105
16	47	V/7343-20	T545V476M016ATE070	3.6	75.2	10	70	1,640	3	105
16	68	W/7343-15	T523W686M016APE050	5.3	108.8	10	50	2,820	3	105
16	68	W/7343-15	T523W686M016APE070	5.3	108.8	10	70	2,376	3	105
16	68	W/7343-15	T523W686M016APE100	5.3	108.8	10	100	1,988	3	105
16	100	W/7343-15	T523W107M016APE050	7.7	160.0	10	50	2,820	3	105
16	100	W/7343-15	T523W107M016APE070	7.7	160.0	10	70	2,376	3	105
16	100	W/7343-15	T523W107M016APE100	7.7	160.0	10	100	1,988	3	105
16	100	V/7343-20	T545V107M016ATE050	7.7	160.0	10	50	1,940	3	105
16	150	W/7343-15	T523W157M016APE050	11.6	240.0	10	50	2,820	3	105
16	150	W/7343-15	T523W157M016APE070	11.6	240.0	10	70	2,376	3	105
16	150	W/7343-15	T523W157M016APE100	11.6	240.0	10	100	1,988	3	105
16	150	V/7343-20	T523V157M016APE050	11.6	240.0	10	50	2,870	3	105
16	150	V/7343-20	T523V157M016APE070	11.6	240.0	10	70	2,420	3	105
16	150	V/7343-20	T523V157M016APE100	11.6	240.0	10	100	2,030	3	105
16	150	V/7343-20	T521V157M016ATE040	11.6	240.0	10	40	2,160	3	105
16	150	V/7343-20	T521V157M016ATE050	11.6	240.0	10	50	1,930	3	105
16	150	V/7343-20	T521V157M016ATE070	11.6	240.0	10	70	1,630	3	105
16	150	V/7343-20	T521V157M016ATE100	11.6	240.0	10	100	1,370	3	105
16	150	X/7343-43	T545X157M016ATE040	11.6	240.0	10	40	2,490	3	105
16	150	G/7360-12	T523G157M016APE150	11.6	240.0	10	150	1,410	4	85
16	180	H/7360-20	T545H187M016ATE055	13.9	288.0	20	55	1,910	3	85
16	220	X/7343-43	T545X227M016ATE035	17.0	352.0	10	35	2,660	3	105
16	220	J/7360-15	T523J227M016APE070	17.0	352.0	10	70	2,510	3	85
VDC	µF	KEMET/ EIA		mJ	µA	%	mΩ	mA		°C
Rated Voltage	Rated Capacitance	Case Code/ Case Size	KEMET Part Number	Energy	Maximum DC Leakage	Maximum DF	Maximum ESR	Maximum Allowable RMS Ripple Current	MSL	Maximum Operating Temperature

Part numbers marked in orange font are not recommended for new designs. KEMET recommends the use of part numbers shown in the above table within same Cap/Volt/Case and ESR in black font text.

(1) To complete KEMET part number, insert M for ±20% or K for ±10%. Designates capacitance tolerance. Refer to Ordering Information for additional detail.

Energy (mJ) = 0.5 * Nominal Cap * (Application Voltage² - Dropout Voltage²) / 1,000; Cap = µF
 Application Voltage = 90% of V_n (≤ 10 V) / 80% of V_n (> 10 V)
 Dropout Voltage = 3 V was used for the calculation

Table 1 – Ratings & Part Number Reference cont.

Rated Voltage	Rated Capacitance	Case Code/ Case Size	KEMET Part Number	Energy	Maximum DC Leakage at 25°C, V _R , 5 min charge time	Maximum DF at 25°C, 120 Hz	Maximum ESR at 25°C, 100 kHz	Maximum Allowable RMS Ripple Current at 45°C, 100 kHz	MSL	Maximum Operating Temperature
VDC	µF	KEMET/ EIA		mJ	µA	%	mΩ	mA		°C
16	220	H/7360-20	T523H227M016APE070	17.0	352.0	10	70	2,510	3	85
16	330	X/7343-43	T545X337(1)016ATE025	25.5	528.0	10	25	3,150	3	105
16	330	H/7360-20	T548H337M016APE070	25.5	528.0	10	70	2,510	4	85
16	330	H/7360-20	T523H337M016APE070	25.5	528.0	10	70	2,510	3	85
16	470	H/7360-20	T523H477M016APE070	36.4	752.0	10	70	2,510	4	85
20	22	B/3528-21	T521B226M020ATE070	2.7	44.0	10	70	1,350	3	105
20	47	W/7343-15	T545W476M020ATE045	5.8	94.0	10	45	2,000	3	105
20	47	W/7343-15	T545W476M020ATE055	5.8	94.0	10	55	1,810	3	105
20	47	V/7343-20	T545V476M020ATE070	5.8	94.0	10	70	1,640	3	105
20	68	W/7343-15	T523W686(1)020APE100	8.4	136.0	10	100	1,988	3	105
20	68	V/7343-20	T523V686M020APE100	8.4	136.0	10	100	2,030	3	105
20	100	W/7343-15	T523W107M020APE050	12.4	200.0	10	50	2,820	3	105
20	100	W/7343-15	T523W107M020APE070	12.4	200.0	10	70	2,376	3	105
20	100	W/7343-15	T523W107M020APE100	12.4	200.0	10	100	1,988	3	105
20	100	V/7343-20	T545V107M020ATE055	12.4	200.0	10	55	1,850	3	125
20	150	V/7343-20	T523V157M020APE050	18.5	300.0	10	50	2,870	3	105
20	150	V/7343-20	T523V157M020APE070	18.5	300.0	10	70	2,420	3	105
20	150	V/7343-20	T523V157M020APE100	18.5	300.0	10	100	2,030	3	105
25	33	W/7343-15	T523W336M025APE100	6.5	82.5	10	100	1,988	3	105
25	47	W/7343-15	T523W476M025APE050	9.2	117.5	10	50	2,820	3	105
25	47	W/7343-15	T523W476M025APE070	9.2	117.5	10	70	2,376	3	105
25	47	W/7343-15	T523W476M025APE100	9.2	117.5	10	100	1,988	3	105
25	47	V/7343-20	T523V476M025APE100	9.2	117.5	10	100	2,030	3	105
25	68	W/7343-15	T523W686M025APE050	13.3	170.0	10	50	2,820	3	105
25	68	W/7343-15	T523W686M025APE070	13.3	170.0	10	70	2,376	3	105
25	68	W/7343-15	T523W686M025APE100	13.3	170.0	10	100	1,988	3	105
25	100	V/7343-20	T523V107M025APE070	19.6	250.0	10	70	2,420	3	105
25	100	V/7343-20	T523V107M025APE100	19.6	250.0	10	100	2,030	3	105
25	150	H/7360-20	T523H157M025APE070	29.3	375.0	10	70	2,510	3	85
25	220	H/7360-20	T523H227M025APE070	43.0	550.0	20	70	2,510	3	85
35	22	W/7343-15	T523W226M035APE100	8.5	77.0	10	100	1,988	3	105
35	33	V/7343-20	T523V336M035APE100	12.8	115.5	10	100	2,030	3	105
35	47	W/7343-15	T523W476M035APE090	18.2	164.5	10	90	2,100	3	105
35	47	W/7343-15	T523W476M035APE100	18.2	164.5	10	100	1,988	3	105
35	47	V/7343-20	T523V476M035APE100	18.2	164.5	10	100	2,030	3	105
35	68	V/7343-20	T523V686M035APE070	26.4	238.0	10	70	2,420	3	105
35	68	V/7343-20	T523V686M035APE100	26.4	238.0	10	100	2,030	3	105
35	100	H/7360-20	T523H107M035APE070	38.8	350.0	10	70	2,510	3	85
VDC	µF	KEMET/ EIA		mJ	µA	%	mΩ	mA		°C
Rated Voltage	Rated Capacitance	Case Code/ Case Size	KEMET Part Number	Energy	Maximum DC Leakage	Maximum DF	Maximum ESR	Maximum Allowable RMS Ripple Current	MSL	Maximum Operating Temperature

Part numbers marked in orange font are not recommended for new designs. KEMET recommends the use of part numbers shown in the above table within same Cap/Volt/Case and ESR in black font text.

(1) To complete KEMET part number, insert M for ±20% or K for ±10%. Designates capacitance tolerance.

Refer to Ordering Information for additional detail.

Energy (mJ) = 0.5 * Nominal Cap * (Application Voltage² - Dropout Voltage²) / 1,000; Cap = µF

Application Voltage = 90% of V_R (< 10 V) / 80% of V_R (> 10 V)

Dropout Voltage = 3 V was used for the calculation

Derating Guidelines

For Parts with Maximum Operational Temperature of 125°C

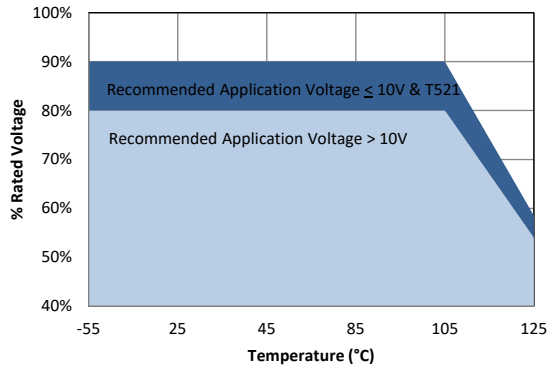

For Parts with Maximum Operational Temperature of 105°C

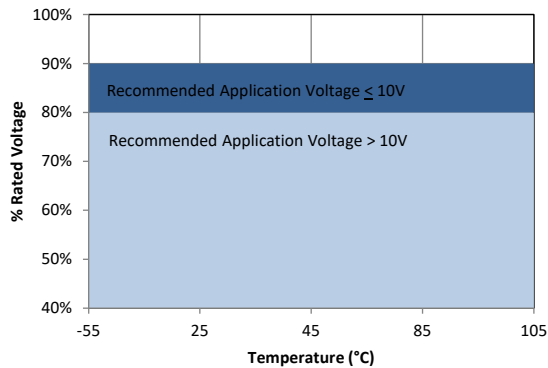

For Parts with Maximum Operational Temperature of 85°C

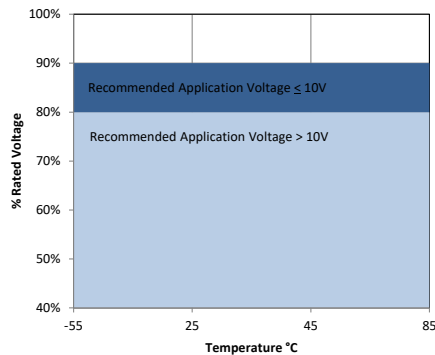

Recommended Application Voltage

KO-CAPs are solid state capacitors that demonstrate no wearout mechanism when operated within their recommended guidelines. While the KO-CAP can be operated at full rated voltage, most circuit designers seek a minimum level of assurance in long term reliability, which should be demonstrated with data. A voltage derating can provide the desired level of demonstrated reliability based on industry accepted acceleration models. Since most applications do require long term reliability, KEMET recommends that designers consider a 10% voltage derating, according to the graphic above, for the maximum steady state voltage.

Ripple Current/Ripple Voltage

Permissible AC ripple voltage and current are related to equivalent series resistance (ESR) and the power dissipation capabilities of the device.

Permissible AC ripple voltage which may be applied is limited by two criteria:

- The positive peak AC voltage plus the DC bias voltage, if any, must not exceed the DC voltage rating of the capacitor.
- The negative peak AC voltage, in combination with bias voltage, if any, must not exceed the allowable limits specified for reverse voltage.

The maximum power dissipation by case size can be determined using the below table.

Temperature Compensation Multipliers for Maximum Ripple Current		
T ≤ 45°C	45° C < T ≤ 85°C	85°C < T ≤ 125°C
1.00	0.70	0.25

T = Environmental temperature

Using the P max of the device, the maximum allowable rms ripple current or voltage may be determined.

$$I(max) = \sqrt{P_{max}/R}$$

$$E(max) = Z \sqrt{P_{max}/R}$$

I = rms ripple current (amperes)

E = rms ripple voltage (volts)

P max = maximum power dissipation(watts)

R = ESR at specified frequency (ohms)

Z = Impedance at specified frequency (Ohms)

Refer to part number listings for permissible Arms limits.

Case Code	EIA Case Code	Maximum Power Dissipation (P max) mWatts at 45°C with +30°C Rise	
		For T520/T521/T545	For T523/T548
T	3528-12	105	N/A
M	3528-15	120	N/A
B	3528-21	127	N/A
W	7343-15	180	395
V	7343-20	187	410
Y	7343-40	241	N/A
X	7343-43	247	N/A
G	7360-12	N/A	300
J	7360-15	200	440
H	7360-20	200	440
O	7360-43	300	N/A

The maximum power dissipation rating must be reduced with increasing environmental operating temperatures. Refer to the Temperature Compensation Multiplier table for details.

Surge Voltage

Surge voltage is the maximum voltage (peak value) which may be applied to the capacitor. The surge voltage must not be applied for periodic charging and discharging in the course of normal operation and cannot be part of the application voltage. Surge voltage capability is demonstrated by application of 1,000 cycles at operating temperature. The parts are charged through a 33 Ohm resistor for 30 seconds and then discharged through a 33 Ohm resistor for each cycle.

Rated Voltage (V)	Surge Voltage (V)	Category Voltage (V)	Category Surge Voltage (V)
-55°C to 105°C		Up to 125°C	
2.5	3.3	-	-
6.3	8.3	-	-
10	13.2	-	-
16	21.1	-	-
20	26.4	13.4	17.4
25	33.0	-	-
35	46.2	-	-

Reverse Voltage

Polymer electrolytic capacitors are polar devices and may be permanently damaged or destroyed if connected in the wrong polarity. These devices will withstand a small degree of transient voltage reversal for short periods as shown in the below table.

Temperature	Permissible Transient Reverse Voltage
25°C	15% of Rated Voltage
55°C	10% of Rated Voltage
85°C	5% of Rated Voltage
105°C	3% of Rated Voltage
125°C*	1% of Rated Voltage

*For series rated to 125°C

Table 2 – Land Dimensions/Courtyard

For T520/T521/T545

KEMET	Metric Size Code	Density Level A: Maximum (Most) Land Protrusion (mm)					Density Level B: Median (Nominal) Land Protrusion (mm)					Density Level C: Minimum (Least) Land Protrusion (mm)					
		Case	EIA	W	L	S	V1	V2	W	L	S	V1	V2	W	L	S	V1
T	3528-12		2.35	2.21	0.92	6.32	4.00	2.23	1.80	1.12	5.22	3.50	2.13	1.42	1.28	4.36	3.24
B	3528-21		2.35	2.21	0.92	6.32	4.00	2.23	1.80	1.12	5.22	3.50	2.13	1.42	1.28	4.36	3.24
M	3528-15		2.35	2.21	0.92	6.32	4.00	2.23	1.80	1.12	5.22	3.50	2.13	1.42	1.28	4.36	3.24
W	7343-15		2.55	2.77	3.67	10.22	5.60	2.43	2.37	3.87	9.12	5.10	2.33	1.99	4.03	8.26	4.84
V	7343-20		2.55	2.77	3.67	10.22	5.60	2.43	2.37	3.87	9.12	5.10	2.33	1.99	4.03	8.26	4.84
Y ¹	7343-40		2.55	2.77	3.67	10.22	5.60	2.43	2.37	3.87	9.12	5.10	2.33	1.99	4.03	8.26	4.84
X ¹	7343-43		2.55	2.77	3.67	10.22	5.60	2.43	2.37	3.87	9.12	5.10	2.33	1.99	4.03	8.26	4.84
J	7360-15		4.25	2.77	3.67	10.22	7.30	4.13	2.37	3.87	9.12	6.80	4.03	1.99	4.03	8.26	6.54
H	7360-20		4.25	2.77	3.67	10.22	7.30	4.13	2.37	3.87	9.12	6.80	4.03	1.99	4.03	8.26	6.54
O ¹	7360-43		4.25	2.77	3.67	10.22	7.30	4.13	2.37	3.87	9.12	6.80	4.03	1.99	4.03	8.26	6.54

Density Level A: For low-density product applications. Recommended for wave solder applications and provides a wider process window for reflow solder processes.

Density Level B: For products with a moderate level of component density. Provides a robust solder attachment condition for reflow solder processes.

Density Level C: For high component density product applications. Before adapting the minimum land pattern variations the user should perform qualification testing based on the conditions outlined in IPC standard 7351 (IPC-7351).

¹ Height of these chips may create problems in wave soldering.

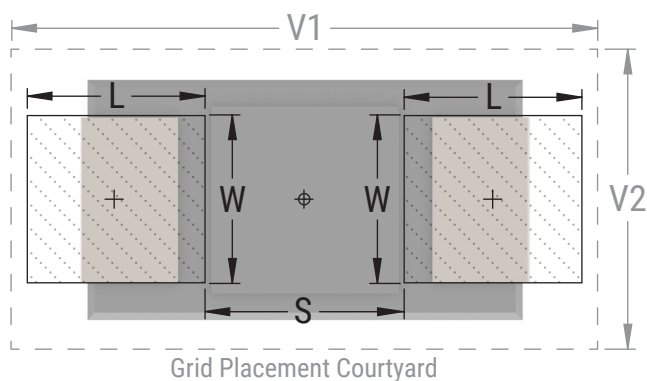

Table 2 – Land Dimensions/Courtyard cont.

For T523/T548

KEMET	Metric Size Code	Density Level A: Maximum (Most) Land Protrusion (mm)					Density Level B: Median (Nominal) Land Protrusion (mm)					Density Level C: Minimum (Least) Land Protrusion (mm)						
		Case	EIA	W	L	S	V1	V2	W	L	S	V1	V2	W	L	S	V1	V2
		W	7343-15	2.55	2.77	3.67	10.22	5.60	2.43	2.37	3.87	9.12	5.10	2.33	1.99	4.03	8.26	4.84
		V	7343-20	2.55	2.77	3.67	10.22	5.60	2.43	2.37	3.87	9.12	5.10	2.33	1.99	4.03	8.26	4.84
		G	7360-12	4.60	3.07	3.07	10.22	7.30	4.48	2.67	3.27	9.12	6.80	4.38	2.29	3.43	8.26	6.54
		J	7360-15	4.60	3.07	3.07	10.22	7.30	4.48	2.67	3.27	9.12	6.80	4.38	2.29	3.43	8.26	6.54
		H	7360-20	4.60	3.07	3.07	10.22	7.30	4.48	2.67	3.27	9.12	6.80	4.38	2.29	3.43	8.26	6.54

Density Level A: For low-density product applications. Recommended for wave solder applications and provides a wider process window for reflow solder processes.

Density Level B: For products with a moderate level of component density. Provides a robust solder attachment condition for reflow solder processes.

Density Level C: For high component density product applications. Before adapting the minimum land pattern variations the user should perform qualification testing based on the conditions outlined in IPC standard 7351 (IPC-7351).

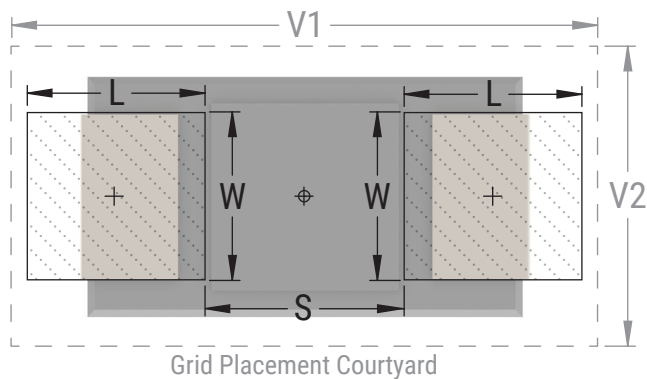

Soldering Process

The KEMET families of surface mount capacitors are compatible with wave (single or dual), convection, IR, or vapor phase reflow techniques. Preheating of these components is recommended to avoid extreme thermal stress. KEMET's recommended profile conditions for convection and IR reflow reflect the profile conditions of the IPC/J-STD-020D standard for moisture sensitivity testing. The devices can safely withstand a maximum of three reflow passes at these conditions.

Please note that although the X/7343-43 and O/7360-43 case size can withstand wave soldering, the tall profile (4.3 mm maximum) dictates care in wave process development.

Hand soldering should be performed with care due to the difficulty in process control. If performed, care should be taken to avoid contact of the soldering iron to the molded case. The iron should be used to heat the solder pad, applying solder between the pad and the termination, until reflow occurs. Once reflow occurs, the iron should be removed immediately. "Wiping" the edges of a chip and heating the top surface is not recommended.

Profile Feature	Pb-Free Assembly
Preheat/Soak	
Temperature Minimum (T_{smin})	150°C
Temperature Maximum (T_{smax})	200°C
Time (t_s) from T_{smin} to T_{smax}	60 – 120 seconds
Ramp-up Rate (T_L to T_p)	3°C/second maximum
Liquidous Temperature (T_L)	217°C
Time Above Liquidous (t_L)	60 – 150 seconds
Peak Temperature (T_p)	250°C* 260°C**
Time within 5°C of Maximum Peak Temperature (t_p)	30 seconds maximum
Ramp-down Rate (T_p to T_L)	6°C/second maximum
Time 25°C to Peak Temperature	8 minutes maximum

Note: All temperatures refer to the center of the package, measured on the package body surface that is facing up during assembly reflow.

* For Case Size height > 2.5 mm

** For Case Size height ≤ 2.5 mm

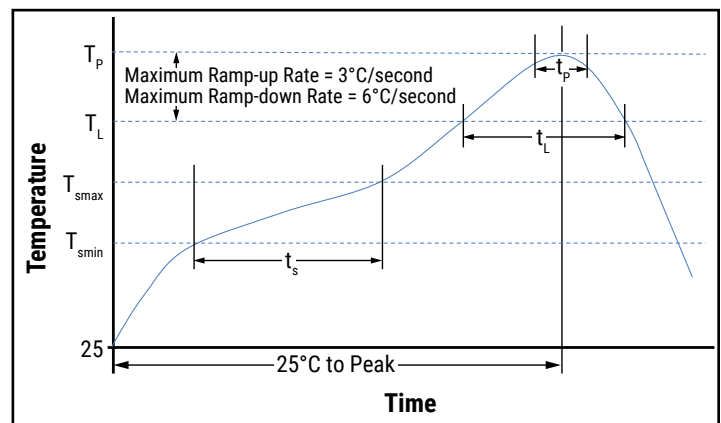

Storage

All KO-Cap are shipped in moisture barrier bags (MBBs) with desiccant and humidity indicator card (HIC). These parts are classified as moisture sensitivity level 3 (MSL3) or moisture sensitivity level 4 (MSL4) per IPC/JEDEC J-STD-020 and packaged per IPC/JEDEC J-STD-033. Refer to Table 1 for part type specification. MSL3 specifies a floor time of 168H at 30°C maximum temperature and 60% relative humidity. MSL4 specifies a floor time of 72H at 30°C maximum temperature and 60% relative humidity. Unused capacitors should be sealed in a MBB with fresh desiccant.

Calculated shelf life in sealed bag:

- 12 months from bag seal date in a storage environment of < 40°C and humidity < 90% RH
- 24 months from bag seal date in a storage environment of < 30°C and humidity < 70% RH

If baking is required, refer to IPC/JEDEC J-STD-033 for bake procedure

Construction

T520/T521/T545

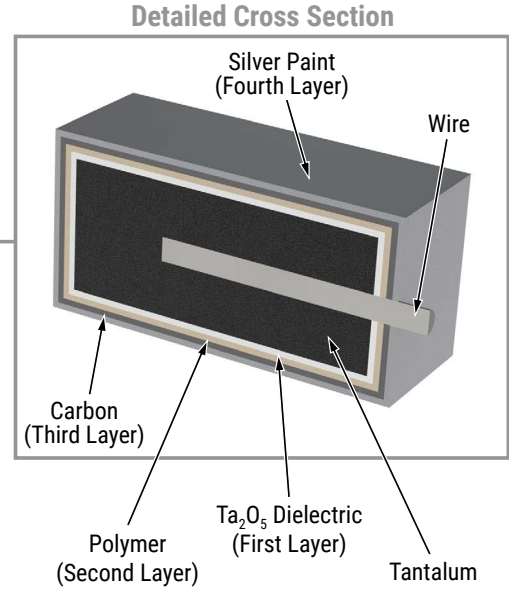
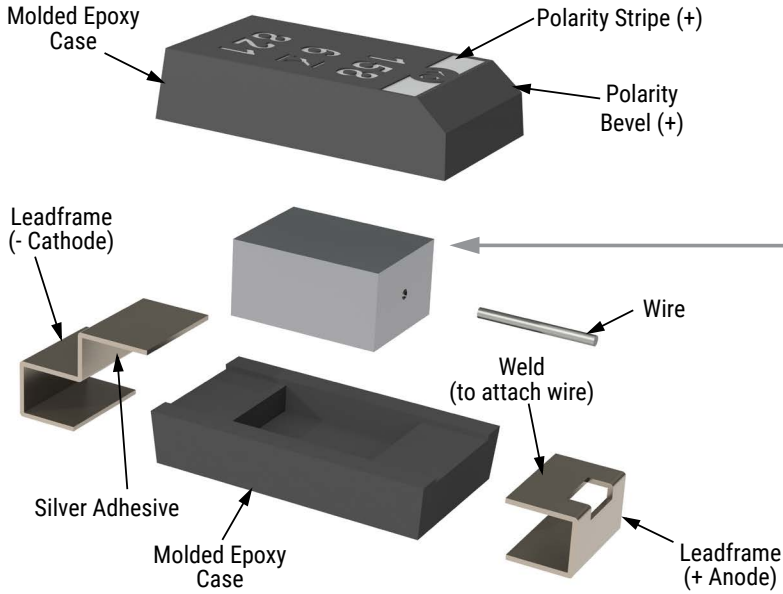

T523/T548

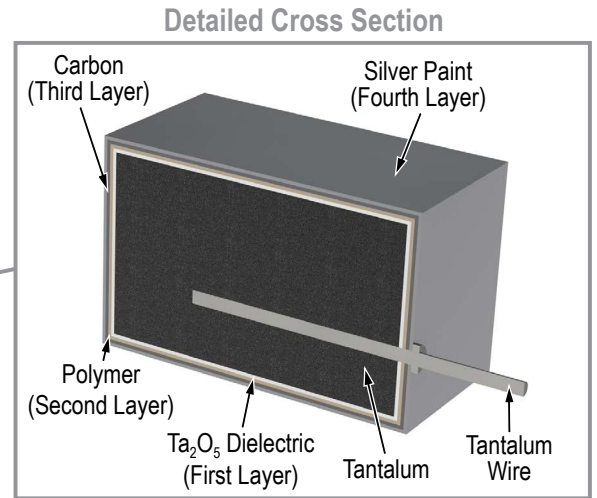
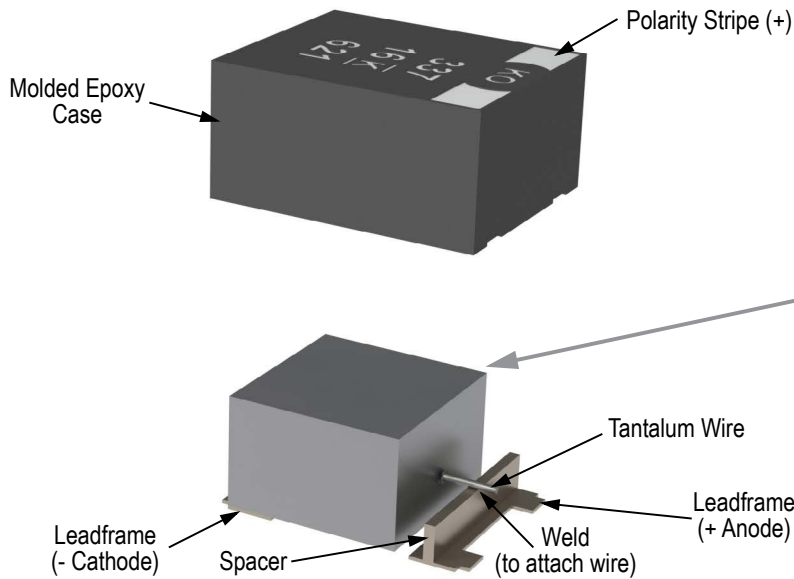

Capacitor Marking

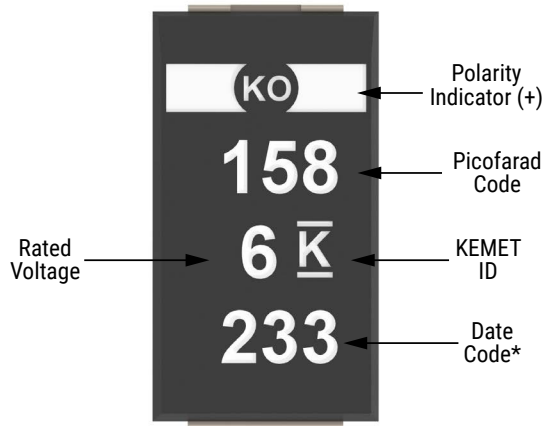

* 233 = 33rd week of 2022

Date Code *	
1 st digit = Last number of year	9 = 2019 0 = 2020 1 = 2021 2 = 2022 3 = 2023
2 nd and 3 rd digit = Week of the year	01 = 1 st week of the year to 52 = 52 nd week of the year

Tape & Reel Packaging Information

KEMET’s molded chip capacitor families are packaged in 8 and 12 mm plastic tape on 7" and 13" reels in accordance with *EIA Standard 481: Embossed Carrier Taping of Surface Mount Components for Automatic Handling*. This packaging system is compatible with all tape-fed automatic pick-and-place systems.

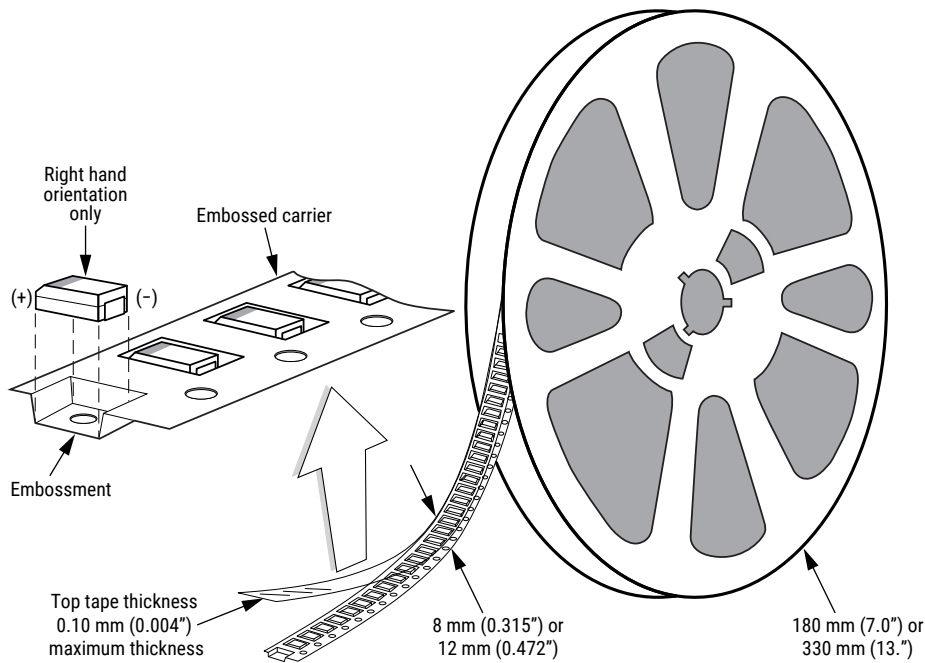

Table 3 – Packaging Quantity

Case Code		Tape Width (mm)	7" Reel*	13" Reel*
KEMET	EIA			
T	3528-12	8	2,500	10,000
M	3528-15	8	2,000	8,000
B	3528-21	8	2,000	8,000
W	7343-15	12	1,000	3,000
V	7343-20	12	1,000	3,000
Y	7343-40	12	500	2,000
X	7343-43	12	500	2,000
J	7360-15	12	1,000	3,000
H	7360-20	12	1,000	3,000
O	7360-43	12	500	2,000

* No C-Spec required for 7" reel packaging. C-7280 required for 13" reel packaging.

Figure 1 – Embossed (Plastic) Carrier Tape Dimensions

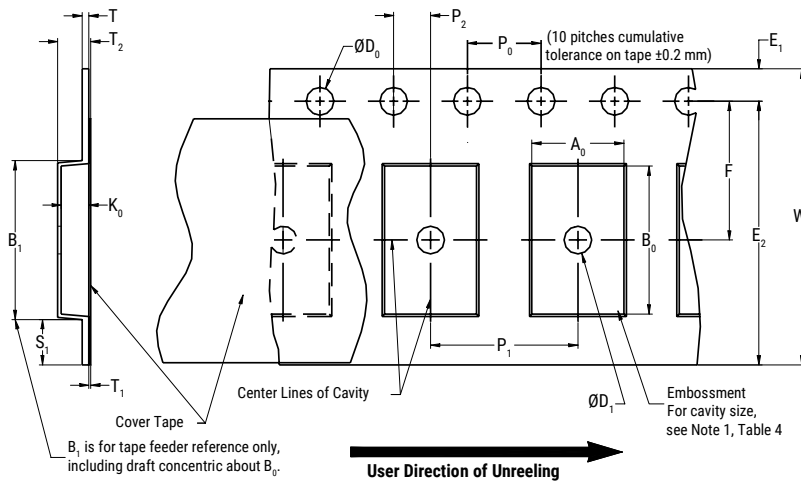

Table 4 – Embossed (Plastic) Carrier Tape Dimensions

Metric will govern

Constant Dimensions – Millimeters (Inches)									
Tape Size	D ₀	D ₁ Minimum Note 1	E ₁	P ₀	P ₂	R Reference Note 2	S ₁ Minimum Note 3	T Maximum	T ₁ Maximum
8 mm	1.5 +0.10/-0.0 (0.059 +0.004/-0.0)	1.0 (0.039)	1.75 ±0.10 (0.069 ±0.004)	4.0 ±0.10 (0.157 ±0.004)	2.0 ±0.05 (0.079 ±0.002)	25.0 (0.984)	0.600 (0.024)	0.600 (0.024)	0.100 (0.004)
12 mm		1.5 (0.059)							

Variable Dimensions – Millimeters (Inches)									
Tape Size	Pitch	B ₁ Maximum Note 4	E ₂ Minimum	F	P ₁	T ₂ Maximum	W Maximum	A ₀ , B ₀ & K ₀	
8 mm	Single (4 mm)	4.35 (0.171)	6.25 (0.246)	3.5 ±0.05 (0.138 ±0.002)	2.0 ±0.05 or 4.0 ±0.10 (0.079 ±0.002 or 0.157 ±0.004)	2.5 (0.098)	8.3 (0.327)	Note 5	
12 mm	Single (4 mm) and Double (8 mm)	8.2 (0.323)	10.25 (0.404)	5.5 ±0.05 (0.217 ±0.002)	2.0 ±0.05 (0.079 ±0.002) or 4.0 ±0.10 (0.157 ±0.004) or 8.0 ±0.10 (0.315 ±0.004)	4.6 (0.181)	12.3 (0.484)		

1. The embossment hole location shall be measured from the sprocket hole controlling the location of the embossment. Dimensions of embossment location and hole location shall be applied independent of each other.
2. The tape, with or without components, shall pass around R without damage (see Figure 4).
3. If S₁ < 1.0 mm, there may not be enough area for cover tape to be properly applied (see EIA Standard 481-D, paragraph 4.3, section b).
4. B₁ dimension is a reference dimension for tape feeder clearance only.
5. The cavity defined by A₀, B₀ and K₀ shall surround the component with sufficient clearance that:
 - (a) the component does not protrude above the top surface of the carrier tape.
 - (b) the component can be removed from the cavity in a vertical direction without mechanical restriction, after the top cover tape has been removed.
 - (c) rotation of the component is limited to 20° maximum for 8 and 12 mm tapes (see Figure 2).
 - (d) lateral movement of the component is restricted to 0.5 mm maximum for 8 mm and 12 mm wide tape (see Figure 3).
 - (e) see Addendum in EIA Standard 481-D for standards relating to more precise taping requirements.

Packaging Information Performance Notes

- Cover Tape Break Force:** 1.0 kg minimum.
- Cover Tape Peel Strength:** The total peel strength of the cover tape from the carrier tape shall be:

Tape Width	Peel Strength
8 mm	0.1 to 1.0 Newton (10 to 100 gf)
12 and 16 mm	0.1 to 1.3 Newton (10 to 130 gf)

The direction of the pull shall be opposite the direction of the carrier tape travel. The pull angle of the carrier tape shall be 165° to 180° from the plane of the carrier tape. During peeling, the carrier and/or cover tape shall be pulled at a velocity of 300 ±10 mm/minute.

- Labeling:** Bar code labeling (standard or custom) shall be on the side of the reel opposite the sprocket holes. Refer to EIA Standards 556 and 624.

Figure 2 – Maximum Component Rotation

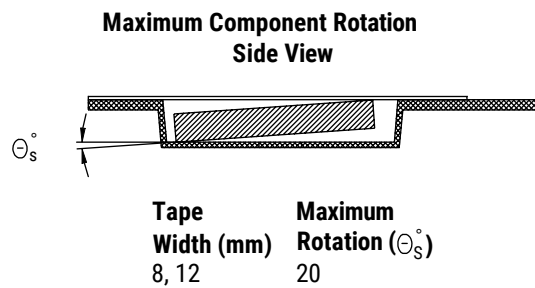
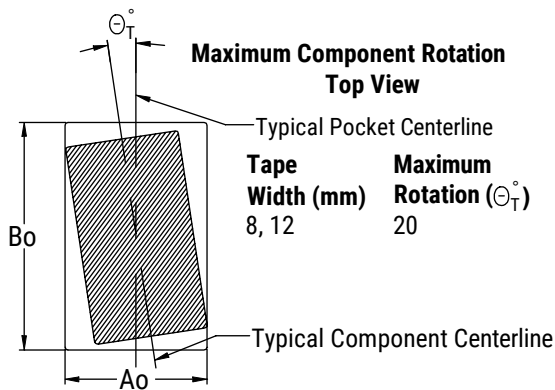

Figure 3 – Maximum Lateral Movement

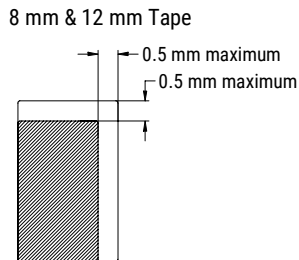

Figure 4 – Bending Radius

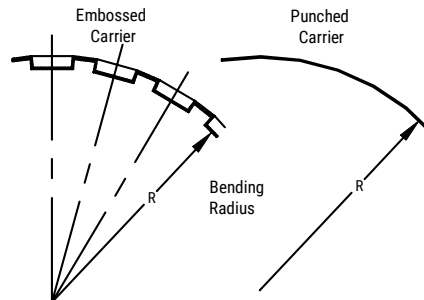
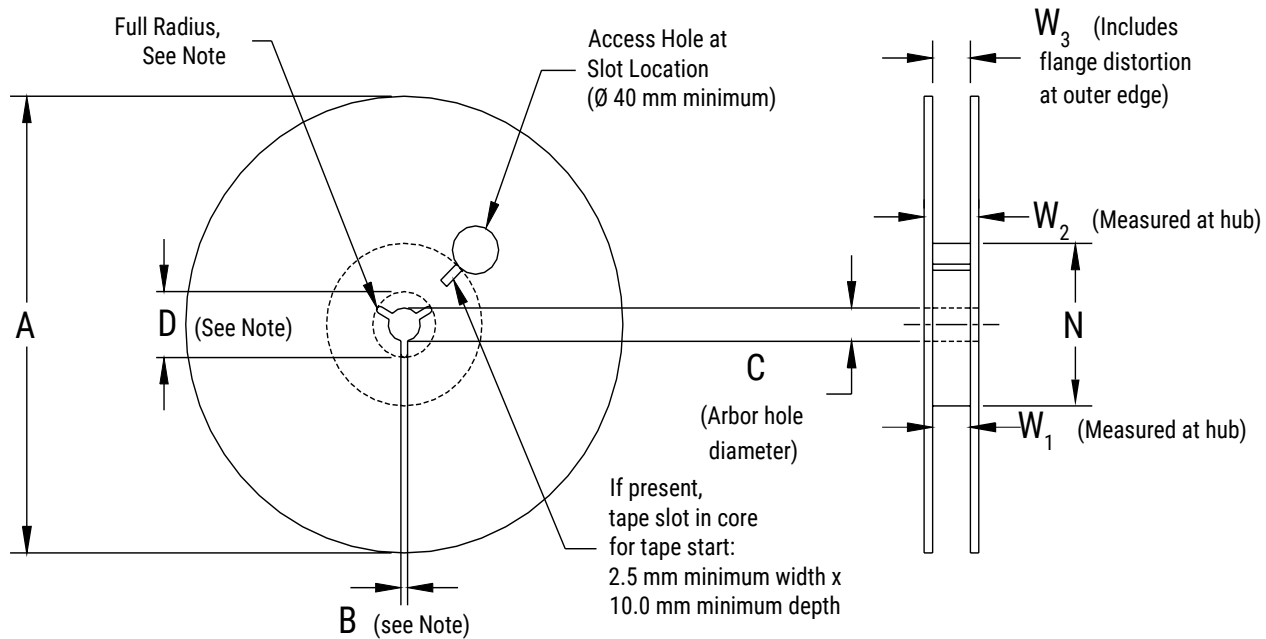

Figure 5 – Reel Dimensions



Note: Drive spokes optional; if used, dimensions B and D shall apply.

Table 5 – Reel Dimensions

Metric will govern

Constant Dimensions – Millimeters (Inches)				
Tape Size	A	B Minimum	C	D Minimum
8 mm	178 ±0.20 (7.008 ±0.008)	1.5 (0.059)	13.0 +0.5/-0.2 (0.521 +0.02/-0.008)	20.2 (0.795)
12 mm	330 ±0.20 (13.000 ±0.008)			
Variable Dimensions – Millimeters (Inches)				
Tape Size	N Minimum	W ₁	W ₂ Maximum	W ₃
8 mm	50 (1.969)	8.4 +1.5/-0.0 (0.331 +0.059/-0.0)	14.4 (0.567)	Shall accommodate tape width without interference
12 mm		12.4 +2.0/-0.0 (0.488 +0.078/-0.0)	18.4 (0.724)	

Figure 6 – Tape Leader & Trailer Dimensions

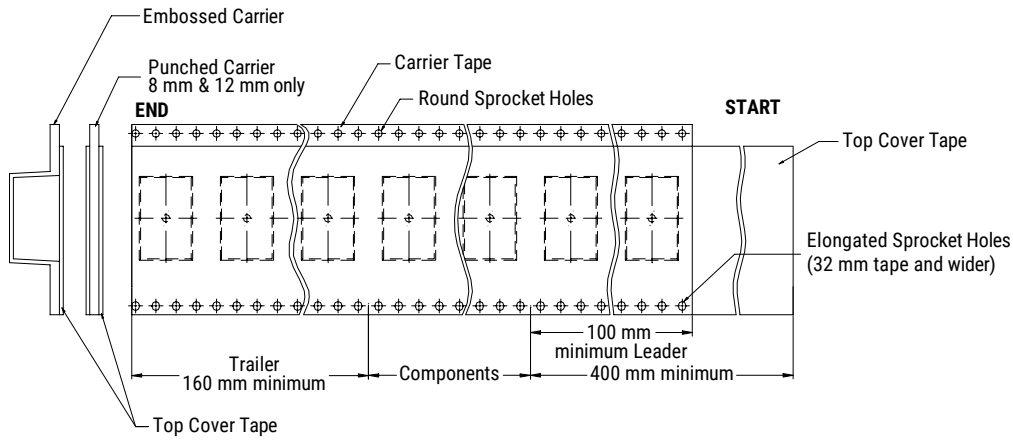

Figure 7 – Maximum Camber



KEMET Electronics Corporation Sales Offices

For a complete list of our global sales offices, please visit www.kemet.com/sales.

Disclaimer

YAGEO Corporation and its affiliates do not recommend the use of commercial or automotive grade products for high reliability applications or manned space flight.

All product specifications, statements, information and data (collectively, the "Information") in this datasheet are subject to change. The customer is responsible for checking and verifying the extent to which the Information contained in this publication is applicable to an order at the time the order is placed. All Information given herein is believed to be accurate and reliable, but it is presented without guarantee, warranty, or responsibility of any kind, expressed or implied.

Statements of suitability for certain applications are based on KEMET Electronics Corporation's ("KEMET") knowledge of typical operating conditions for such applications, but are not intended to constitute – and KEMET specifically disclaims – any warranty concerning suitability for a specific customer application or use. The Information is intended for use only by customers who have the requisite experience and capability to determine the correct products for their application. Any technical advice inferred from this Information or otherwise provided by KEMET with reference to the use of KEMET's products is given gratis, and KEMET assumes no obligation or liability for the advice given or results obtained.

Although KEMET designs and manufactures its products to the most stringent quality and safety standards, given the current state of the art, isolated component failures may still occur. Accordingly, customer applications which require a high degree of reliability or safety should employ suitable designs or other safeguards (such as installation of protective circuitry or redundancies) in order to ensure that the failure of an electrical component does not result in a risk of personal injury or property damage.

Although all product-related warnings, cautions and notes must be observed, the customer should not assume that all safety measures are indicated or that other measures may not be required.

KEMET is a registered trademark of KEMET Electronics Corporation.