

Overview

The KEMET Tantalum Stack Polymer (TSP) Electrolytic Capacitor is designed to provide the highest CV (capacitance/voltage) ratings in a surface mount configuration. All of KEMET's Polymer Electrolytic Solutions are available in a stack configuration. The only exceptions are the facedown series (T523, T527, T528, and T529). These capacitors are utilized in stacks of 2, 3, 4, and 6 components to achieve a broad range of capacitance, ESR, and voltage ratings. The TSP series may be operated at steady state voltages up to 90% of rated voltage for part types with rated voltage less than or equal to 10 volts and up to 80% of rated voltage for part types greater than 10 volts. Stacking configurations allow for custom capacitance/voltage solutions and very low ESR options.

KO-CAP Polymer Capacitors

The TSP series is the first polymer electrolytic capacitor available with failure rate options when utilizing KEMET's T540 and T541 Series. The failure rate is determined by utilizing accelerated conditions (voltage and temperature) applied to board mounted samples to assess long term device reliability. The failure rates available are B (0.1% per 1,000 hours), C (0.01% per 1,000 hours), and D (0.001% per 1,000 hours). This method was developed based on over ten (10) years of research and is described in numerous papers available on www.kemet.com.

Note: Custom stacking solutions are also available with other KEMET Polymer Electrolytic Surface Mount products. Please contact KEMET Sales for availability.

Benefits

- Polymer cathode technology
- High capacitance
- Surface mountable
- Capacitance values of 20 – 8,000 μF
- Capacitance can be custom specified
- Voltage ratings of 3 – 63 VDC
- High volumetric efficiency
- Ultra low ESR
- Surge capability
- Operating temperature range of -55°C to $+105^{\circ}\text{C}/+125^{\circ}\text{C}$ (refer to part number for maximum temperature rating)
- Laser-marked case
- Use up to 90% of rated voltage for part types $\leq 10\text{ V}$
- Use up to 80% of rated voltage for part types $> 10\text{ V}$
- KEMET's KO-CAP Reliability Assessment method (for the discrete component T540 and T541)



Applications

Typical applications include decoupling, hold-up and filtering in a variety of market segments. The T540/T541 and T543 Polymer HRA and other tantalum MnO₂ HRA and MIL-PRF stack devices can be utilized in defense and aerospace equipment including High Power Amplifiers for radars and multiple applications where GaN active components are part of the design.

Environmental Compliance

RoHS compliant when ordered with 100% Sn solder on both terminations (component and stack)

- Halogen-free
- Epoxy compliant with UL94 V-0
- Molded Epoxy complies for outgassing testing under ASTM E 595.

K-SIM

For a detailed analysis of specific part numbers, please visit ksim.kemet.com to access KEMET's K-SIM software. KEMET K-SIM is designed to simulate behavior of components with respect to frequency, ambient temperature, and DC bias levels.

Ordering Information

T540/T541 Discrete Component

T	SP	2D	207	M	010	A	H	65	20	D	540
Capacitor Class	Series	Case Size	Capacitance Code (pF)	Capacitance Tolerance	Rated Voltage (VDC)	Failure Rate (Discrete)	Termination Finish (Discrete)	Surge (Discrete)	ESR (Stack)	Termination Finish (Stack)	Discrete Components Series
T = Tantalum	Stacks Polymer Cathode	2B 3B 4B 6B 2C 3C 4C 6C 2D 3D 4D 6D 20 30 40 60 2X 3X 4X 6X	First two digits represent significant figures. Third digit specifies number of zeros.	K = ±10% M = ±20%	003 = 3 004 = 4 006 = 6.3 010 = 10 016 = 16 025 = 25 035 = 35 050 = 50 063 = 63	A = N/A B = 0.1%/Khrs C = 0.01%/Khrs D = 0.001%/Khrs	H = Standard solder coated (SnPb 5% Pb minimum) T = 100% Matte Tin (Sn)-plated	65 = 4 cycles at 25°C ±5°C 66 = 10 cycles at 25°C 67 = 10 cycles at -55°C +0°C/-5°C and 85°C 85 = 4 cycles at 25°C ±5°C and improved humidity capability 86 = 10 cycles at 25°C ±5°C and improved humidity capability 87 = 10 cycles at -55°C +0°C/-5°C and +85°C ±5°C and improved humidity capability	05 = ESR - High 10 = ESR - Standard 20 = ESR-Low	D = Silver-plated (Ag) H = Solder-plated (SnPb 5% Pb minimum) T = 100% Tin (Sn) X = Leadless stack assembly *1	540 = T540 541 = T541

*1 Available for 0 case discrete stack configurations

Ordering Information cont.

T543 Discrete Component

T	SP	6X	207	M	050	A	H	E	040	D	543
Capacitor Class	Series	Case Size	Capacitance Code (pF)	Capacitance Tolerance	Rated Voltage (VDC)	Failure Rate (Discrete)	Termination Finish (Discrete)	Surge (Discrete)	ESR (Discrete)	Termination Finish (Stack)	Discrete Components Series
T = Tantalum	Stacks Polymer Cathode	2B 3B 4B 6B 2C 3C 4C 6C 2D 3D 4D 6D 20 30 40 60 2X 3X 4X 6X	First two digits represent significant figures. Third digit specifies number of zeros.	K = ±10% M = ±20%	003 = 3 004 = 4 006 = 6.3 010 = 10 016 = 16 025 = 25 035 = 35 040 = 40 050 = 50 063 = 63	A = N/A	H = Standard solder coated (SnPb 5% Pb minimum) T = 100% Matte Tin (Sn)-plated	E = None S = 10 cycles at 25°C W = 10 cycles -55°C and 85°C	ESR in mΩ	D = Silver-plated (Ag) H = Solder-plated (SnPb 5% Pb minimum) T = 100% Tin (Sn) X = Leadless stack assembly *1	543 = T543

*1 Available for 0 case discrete stack configurations

T520, T521, T525, T530, T545 Discrete Component

T	SP	2X	667	M	10	A	T	E	002	D	530
Capacitor Class	Series	Case Size	Capacitance Code (pF)	Capacitance Tolerance	Rated Voltage (VDC)	Failure Rate (Discrete)	Termination Finish (Discrete)	Surge (Discrete)	ESR (Stack)	Termination Finish (Stack)	Discrete Components Series
T = Tantalum	Stacks Polymer Cathode	2B 3B 4B 6B 2C 3C 4C 6C 2D 3D 4D 6D 20 30 40 60 2X 3X 4X 6X	First two digits represent significant figures. Third digit specifies number of zeros.	K = ±10% M = ±20%	003 = 3 004 = 4 006 = 6.3 010 = 10 016 = 16 025 = 25 035 = 35 050 = 50 063 = 63	A = N/A	H = Standard solder coated (SnPb 5% Pb minimum) T = 100% Matte Tin (Sn)-plated	E = None	ESR in mΩ	D = Silver-plated (Ag) H = Solder-plated (SnPb 5% Pb minimum) T = 100% Tin (Sn)	520 = T520 521 = T521 525 = T525 530 = T530 545 = T545

Note: Custom discrete component stacking solutions are also available with other KEMET Polymer Electrolytic Surface Mount series/products. Please contact KEMET Sales for availability.

Performance Characteristics

Item	Performance Characteristics
Operating Temperature	-55°C to 105°C/125°C (refer to part number for maximum temperature rating)
Rated Capacitance Range	20 – 8,000 µF at 120 Hz/25°C
Capacitance Tolerance	M Tolerance (20%)
Rated Voltage Range	3 – 63 V
DF (120 Hz)	Refer to Part Number Electrical Specification Table
ESR (100 kHz)	Refer to Part Number Electrical Specification Table
Leakage Current	≤ 0.1 CV (µA) at rated voltage after 5 minutes

Qualification

Test	Condition	Characteristics	
Endurance	105°C at rated voltage, 2,000 hours 125°C at 2/3 rated voltage, 2,000 hours	Δ C/C	Within -20/+10% of initial value
		DF	≤ initial limit
		DCL	1.25 x IL at 125°C
		ESR	2 x initial limit
Thermal Shock	KEMET specified test, mounted, -55°C to 105°C/125°C*, 5 cycles	Δ C/C	Within ±5% of initial value
		DF	Within initial limits
		DCL	Within 1.25 x initial limit
		ESR	Within initial limits
Surge Voltage	85°C, 1.15 x rated voltage 1,000 cycles	Δ C/C	Within ±5% of initial value
		DF	Within initial limits
		DCL	Within initial limits
		ESR	Within initial limits
Surge Voltage	105°C/125°C*, 0.77 x rated voltage 1,000 cycles	Δ C/C	Within ±5% of initial value
		DF	Within initial limits
		DCL	Within initial limits
		ESR	Within initial limits
Mechanical Vibration	MIL-STD-202, Method 204, Condition D, 10 Hz to 2,000 Hz, 20 G peak	Δ C/C	Within ±10 of initial value
		DF	Within initial limits
		DCL	Within initial limits

*1 Refer to part number specifications for individual temperature classification

Reliability

KO-CAP capacitors have an average failure rate of 0.5 %/1,000 hours at category voltage, U_C , and category temperature, T_C . These capacitors are qualified using industry test standards at U_C and T_C . The minimum test time (1,000 or 2,000 hours) is dependent on the product.

The actual life expectancy of KO-CAP capacitors increases when application voltage, U_A , and application temperature, T_A , are lower than U_C and T_C . As a general guideline, when $U_A < 0.9 * U_C$ and $T_A < 85^\circ\text{C}$, the life expectancy will typically exceed the useful lifetime of most hardware (> 10 years).

The lifetime of a KO-CAP capacitor at a specific application voltage and temperature can be modeled using the equations below. A failure is defined as passing enough current to blow a 1-Amp fuse. The calculation is an estimation based on empirical results and is not a guarantee.

$$VAF = \left(\frac{U_C}{U_A}\right)^n$$

where:

VAF = acceleration factor due to voltage, unitless

U_C = category voltage, volt

U_A = application voltage, volt

n = exponent, 16

$$TAF = e^{\left[\frac{E_a}{k} \left(\frac{1}{273+T_A} - \frac{1}{273+T_C}\right)\right]}$$

where:

TAF = acceleration factor due to temperature, unitless

E_a = activation energy, 1.4 eV

k = Boltzmann's constant, 8.617E-5 eV/K

T_A = application temperature, °C

T_C = category temperature, °C

$$AF = VAF * TAF$$

where:

AF = acceleration factor, unitless

TAF = acceleration factor due to temperature, unitless

VAF = acceleration factor due to voltage, unitless

$$Life_{U_A, T_A} = Life_{U_C, T_C} * AF$$

where:

$Life_{U_A, T_A}$ = estimated life application voltage and temperature, years

$Life_{U_C, T_C}$ = guaranteed life category voltage and temperature, years

AF = acceleration factor, unitless

Reliability Table 1 – Common temperature range classifications

85°C (T_R) / 85°C (T_C)	Rated Voltage (U_R)	2.5	4.0	6.3	8.0	10.0	12.5	16.0	20.0	25.0	35.0	50.0	63.0	75.0
	Category Voltage (U_C)	2.5	4.0	6.3	8.0	10.0	12.5	16.0	20.0	25.0	35.0	50.0	63.0	75.0
105°C (T_R) / 105°C (T_C)	Rated Voltage (U_R)	2.5	4.0	6.3	8.0	10.0	12.5	16.0	20.0	25.0	35.0	50.0	63.0	75.0
	Category Voltage (U_C)	2.5	4.0	6.3	8.0	10.0	12.5	16.0	20.0	25.0	35.0	50.0	63.0	75.0
105°C (T_R) / 125°C (T_C)	Rated Voltage (U_R)	2.5	4.0	6.3	8.0	10.0	12.5	16.0	20.0	25.0	35.0	50.0	63.0	75.0
	Category Voltage (U_C)	1.7	2.7	4.2	5.4	6.7	8.4	10.7	13.4	16.8	23.5	33.5	42.2	50.3

Terms:

Category Voltage, U_C : Maximum recommended peak DC operating voltage for continuous operation at the category temperature, T_C

Rated Voltage, U_R : Maximum recommended peak DC operating voltage for continuous operation up to the rated temperature, T_R

Category Temperature, T_C : Maximum recommended operating temperature; voltage derating may be required at T_C

Rated Temperature, T_R : Maximum recommended operating temperature without voltage derating; T_R is equal to or lower than T_C

Dimensions – Millimeters (Inches)

Metric will govern

TSP2

KEMET 2 Component Stack Dimensions						
Case Code	L	W	H	W ₂	H ₂	P
2C	6.5 ±0.38 (0.258 ±0.015)	3.3 ±0.2 (0.130 ±0.008)	5.3 ±0.38 (0.210 ±0.015)	2.5 ±0.2 (0.100 ±0.008)	4.5 ±0.38 (0.176 ±0.015)	1.4 ±0.38 (0.055 ±0.015)
2B	4.1 ±0.38 (0.162 ±0.015)	3.1 ±0.2 (0.122 ±0.008)	4.3 ±0.38 (0.170 ±0.015)	2.3 ±0.2 (0.090 ±0.008)	3.1 ±0.38 (0.124 ±0.015)	0.76 ±0.38 (0.030 ±0.015)
2D	8.0 ±0.38 (0.315 ±0.015)	4.4 ±0.2 (0.174 ±0.008)	6.2 ±0.38 (0.245 ±0.015)	3.0 ±0.2 (0.120 ±0.008)	4.8 ±0.38 (0.192 ±0.015)	1.9 ±0.38 (0.075 ±0.015)
2X	8.0 ±0.38 (0.315 ±0.015)	4.4 ±0.2 (0.174 ±0.008)	8.9 ±0.38 (0.350 ±0.015)	3.0 ±0.2 (0.120 ±0.008)	6.9 ±0.38 (0.272 ±0.015)	1.9 ±0.38 (0.075 ±0.015)
20	7.9 ±0.38 (0.311 ±0.015)	6.1 ±0.4 (0.240 ±0.016)	8.9 ±0.38 (0.350 ±0.015)	4.1 ±0.4 (0.161 ±0.016)	6.6 ±0.38 (0.260 ±0.015)	1.4 ±0.38 (0.055 ±0.015)

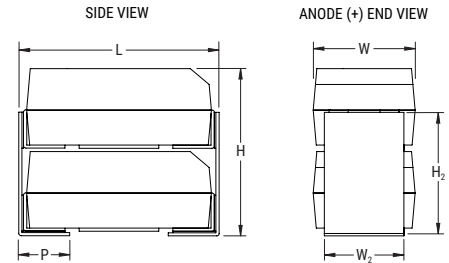

TSP3

KEMET 3 Component Stack Dimensions						
Case Code	L	W	H	W ₂	H ₂	P
3B	4.1 ±0.38 (0.162 ±0.015)	3.1 ±0.2 (0.122 ±0.008)	6.3 ±0.38 (0.248 ±0.015)	2.3 ±0.2 (0.090 ±0.008)	5.3 ±0.38 (0.210 ±0.015)	0.76 ±0.38 (0.030 ±0.015)
3D	8.0 ±0.38 (0.315 ±0.015)	4.4 ±0.2 (0.174 ±0.008)	9.2 ±0.38 (0.365 ±0.015)	3.0 ±0.2 (0.120 ±0.008)	7.7 ±0.38 (0.304 ±0.015)	1.9 ±0.38 (0.075 ±0.015)
3X	8.0 ±0.38 (0.315 ±0.015)	4.4 ±0.2 (0.174 ±0.008)	13.3 ±0.38 (0.525 ±0.015)	3.0 ±0.2 (0.120 ±0.008)	11.0 ±0.38 (0.436 ±0.015)	1.9 ±0.38 (0.075 ±0.015)
30	7.9 ±0.38 (0.311 ±0.015)	6.1 ±0.4 (0.240 ±0.016)	13.3 ±0.38 (0.525 ±0.015)	4.1 ±0.2 (0.16 ±0.008)	11.0 ±0.38 (0.436 ±0.015)	1.4 ±0.38 (0.060 ±0.015)

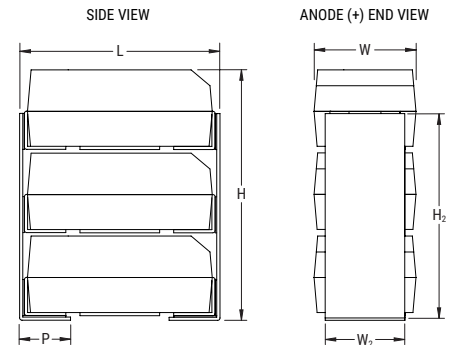

Dimensions – Millimeters (Inches) cont.

Metric will govern

TSP4

KEMET 4 Component Stack Dimensions						
Case Code	L	W	H	W2	H2	P
4B	4.1 ±0.38 (0.162 ±0.015)	6.1 ±0.2 (0.242 ±0.008)	4.3 ±0.38 (0.170 ±0.015)	5.3 ±0.2 (0.210 ±0.008)	3.1 ±0.38 (0.124 ±0.015)	0.76 ±0.38 (0.030 ±0.015)
4D	8.0 ±0.38 (0.315 ±0.015)	8.9 ±0.2 (0.350 ±0.008)	6.2 ±0.38 (0.245 ±0.015)	7.4 ±0.2 (0.292 ±0.008)	4.8 ±0.38 (0.192 ±0.015)	1.9 ±0.38 (0.075 ±0.015)
4X	8.0 ±0.38 (0.315 ±0.015)	8.9 ±0.2 (0.350 ±0.008)	8.9 ±0.38 (0.350 ±0.015)	7.4 ±0.2 (0.292 ±0.008)	6.9 ±0.38 (0.272 ±0.015)	1.9 ±0.38 (0.075 ±0.015)
4O	7.9 ±0.38 (0.311 ±0.015)	12.2 ±0.4 (0.48 ±0.016)	8.9 ±0.38 (0.350 ±0.015)	10.5 ±0.4 (0.413 ±0.016)	6.6 ±0.38 (0.260 ±0.015)	1.4 ±0.38 (0.055 ±0.015)

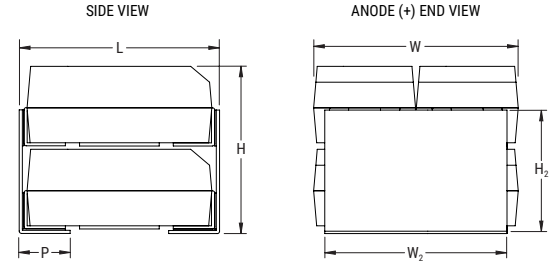

TSP6

KEMET 6 Component Stack Dimensions						
Case Code	L	W	H	W2	H2	P
6B	4.1 ±0.38 (0.162 ±0.015)	6.1 ±0.2 (0.242 ±0.008)	6.3 ±0.38 (0.248 ±0.015)	5.3 ±0.2 (0.210 ±0.008)	5.3 ±0.38 (0.210 ±0.015)	0.76 ±0.38 (0.030 ±0.015)
6D	8.0 ±0.38 (0.315 ±0.015)	8.9 ±0.2 (0.350 ±0.008)	9.2 ±0.38 (0.365 ±0.015)	7.4 ±0.2 (0.292 ±0.008)	7.7 ±0.38 (0.304 ±0.015)	1.9 ±0.38 (0.075 ±0.015)
6X	8.0 ±0.38 (0.315 ±0.015)	8.9 ±0.2 (0.350 ±0.008)	13.3 ±0.38 (0.525 ±0.015)	7.4 ±0.2 (0.292 ±0.008)	11.0 ±0.38 (0.436 ±0.015)	1.9 ±0.38 (0.075 ±0.015)
6O	8.0 ±0.38 (0.315 ±0.015)	12.2 ±0.4 (0.48 ±0.016)	13.3 ±0.38 (0.525 ±0.015)	10.5 ±0.4 (0.413 ±0.016)	11.0 ±0.38 (0.436 ±0.015)	1.4 ±0.38 (0.055 ±0.015)

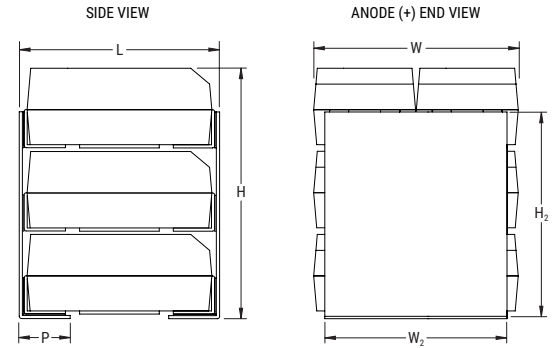

Table 1A – TSP2 Ratings & Part Number Reference

Rated Voltage	Rated Capacitance	Case Code/ Case Size	KEMET Part Number	DC Leakage	DF	Standard ESR	Low ESR	Ultra Low ESR	Maximum Operating Temp
VDC at 105°C	µF	KEMET/EIA	(See below for part options)	µA at +25°C Max/5 Min	% at +25°C 120 Hz Max	mΩ at +25°C 100 kHz Max	mΩ at +25°C 100 kHz Max	mΩ at +25°C 100 kHz Max	°C
4	200	2B	TSP2B207(4)004(6)(3)(1)10(5)540	80	8	40	N/A	N/A	125
6.3	130	2B	TSP2B137(4)006(6)(3)(1)10(5)540	86	8	40	N/A	N/A	125
10	66	2B	TSP2B666(4)010(6)(3)(1)10(5)540	66	8	40	N/A	N/A	125
3	660	2D	TSP2D667(4)003(6)(3)(1)10(5)540	198	10	13	N/A	N/A	125
3	1400	2D	TSP2D148(4)003(6)(3)(1)10(5)540	408	10	13	N/A	N/A	125
4	440	2D	TSP2D447(4)004(6)(3)(1)10(5)540	176	10	13	N/A	N/A	125
4	940	2D	TSP2D947(4)004(6)(3)(1)2(5)540	376	10	20	13	N/A	125
6.3	660	2D	TSP2D667(4)006(6)(3)(1)2(5)540	416	10	20	13	N/A	125
10	200	2D	TSP2D207(4)010(6)(3)(1)2(5)540	200	10	28	13	N/A	125
10	300	2D	TSP2D307(4)010(6)(3)(1)2(5)540	300	10	28	13	N/A	125
10	440	2D	TSP2D447(4)010(6)(3)(1)10(5)540	440	10	13	N/A	N/A	125
16	94	2D	TSP2D946(4)016(6)(3)(1)2(5)540	152	10	33	18	N/A	125
4	1,300	2X	TSP2X138(4)004(6)(3)(1)2(5)541	520	10	5	3	N/A	125
4	2,000	2X	TSP2X208(4)004(6)(3)(1)2(5)541	800	10	5	3	N/A	125
6.3	940	2X	TSP2X947(4)006(6)(3)(1)2(5)541	564	10	5	3	N/A	125
10	660	2X	TSP2X667(4)010(8)(3)(1)2(5)541	660	10	5	3	N/A	125
16	300	2X	TSP2X307(4)016(6)(3)(1)2(5)541	480	10	20	12	N/A	125
16	440	2X	TSP2X447(4)016(6)(3)(1)2(5)541	704	10	20	12	N/A	125
16	660	2X	TSP2X667(4)016(6)(3)(1)2(5)541	1,056	10	25	12	N/A	125
25	130	2X	TSP2X137(4)025(6)(3)(1)10(5)541	325	10	25	N/A	N/A	125
35	66	2X	TSP2X666(4)035(8)(3)(1)10(5)541	231	10	30	N/A	N/A	125
35	94	2X	TSP2X946(4)035(8)(3)(1)10(5)541	329	10	30	N/A	N/A	125
50	44	2X	TSP2X446(4)050(8)(3)(1)10(5)541	220	10	40	N/A	N/A	125
50	66	2X	TSP2X666(4)050(8)(3)(1)10(5)541	330	10	40	N/A	N/A	125
63	20	2X	TSP2X206(4)063(8)(3)(1)2(5)541	126	10	75	50	N/A	125
63	30	2X	TSP2X306(4)063(8)(3)(1)10(5)541	189	10	25	N/A	N/A	125

- (1) To complete KEMET part number, insert 65 = 4 cycles +25°C, 66 = 10 cycles +25°C, 67 = 10 cycles -55°C +85°C, 85 = 4 cycles + 25°C + improved humidity, 86 = 10 cycles +25°C +improved humidity, 87 = 10 cycles +55°C and +85°C + improved humidity. Designates surge current option
- (2) To complete KEMET part number, insert 05= High ESR, 10 = Standard ESR, 20 = Low ESR. Designates ESR option.
- (3) To complete KEMET part number, insert H = Standard solder coated or T = 100% Tin
- (4) To complete KEMET part number, insert M for ±20%, K for ±10%. Designates Capacitance tolerance.
- (5) To complete KEMET part number, insert D = Silver-plated (Ag), H = Solder-plated, or T = 100% Tin (Sn). Designates Termination Finish (stack)
- (6) To complete KEMET part number, insert D (0.001%/1,000 hours), C (0.01%/1,000 hours), B (0.1%/1,000 hours), or A = N/A. Designates Reliability Level.
- (7) To complete KEMET part number, insert E = None, S = 10 cycles at +25°C, W = 10 cycles -55°C and +85°C. Designates surge current option for T543 discrete component
- (8) To complete KEMET part number, C (0.01%/1,000 hours), B (0.1%/1,000 hours), or A = N/A. Designates Reliability Level.
- (9) To complete KEMET part number, insert D = Silver-plated (Ag), H = Solder-plated, T = 100% Tin (Sn) or X = Leadless stack.
- Please contact your sales representative for availability of engineering samples.

Table 1A – TSP2 Ratings & Part Number Reference cont.

Rated Voltage	Rated Capacitance	Case Code/ Case Size	KEMET Part Number	DC Leakage	DF	Standard ESR	Low ESR	Ultra Low ESR	Maximum Operating Temp
VDC at 105°C	µF	KEMET/EIA	(See below for part options)	µA at +25°C Max/5 Min	% at +25°C 120 Hz Max	mΩ at +25°C 100 kHz Max	mΩ at +25°C 100 kHz Max	mΩ at +25°C 100 kHz Max	°C
3	4,000	20	TSP20408M003(6)(3)(1)10(9)541	1,200	10	7	N/A	N/A	125
4	3,000	20	TSP20308M004(6)(3)(1)10(9)541	1,200	10	7	N/A	N/A	125
6.3	2,000	20	TSP20208M006(6)(3)(1)10(9)541	1,260	10	8	N/A	N/A	125
10	1,300	20	TSP20138M010(6)(3)(1)10(9)541	1,300	10	10	N/A	N/A	125
16	940	20	TSP20947M016(6)(3)(1)2(9)541	1,504	10	25	15	N/A	125
25	300	20	TSP20307M025(6)(3)(1)10(9)541	750	10	25	N/A	N/A	125
30	300	20	TSP20307M030(8)(3)(1)2(9)541	900	10	30	20	N/A	125
35	130	20	TSP20137M035(8)(3)(1)10(9)541	455	10	25	N/A	N/A	125
50	94	20	TSP20946M050(8)(3)(1)10(9)541	470	10	35	N/A	N/A	125
63	44	20	TSP20446M063(8)(3)(1)10(9)541	277	10	25	N/A	N/A	125
3	4,000	20	TSP20408M003A(3)(7)010(9)543	1,200	10	7	N/A	N/A	105
4	3,000	20	TSP20308M004A(3)(7)010(9)543	1,200	10	7	N/A	N/A	105
6.3	2,000	20	TSP20208M006A(3)(7)015(9)543	1,260	10	10	N/A	N/A	105
6.3	2,000	20	TSP20208M006A(3)(7)010(9)543	1,260	10	N/A	7	N/A	105
10	1,300	20	TSP20138M010A(3)(7)015(9)543	1,300	10	10	N/A	N/A	105
16	940	20	TSP20947M016A(3)(7)040(9)543	1,504	10	25	N/A	N/A	105
16	940	20	TSP20947M016A(3)(7)020(9)543	1,504	10	N/A	15	N/A	105
25	300	20	TSP20307M025A(3)(7)045(9)543	750	10	25	N/A	N/A	105
30	300	20	TSP20307M030A(3)(7)055(9)543	900	10	30	N/A	N/A	105
30	300	20	TSP20307M030A(3)(7)045(9)543	900	10	N/A	25	N/A	105
30	300	20	TSP20307M030A(3)(7)030(9)543	900	10	N/A	N/A	20	105
35	130	20	TSP20137M035A(3)(7)045(9)543	455	10	25	N/A	N/A	105
35	130	20	TSP20137M035A(3)(7)025(9)543	455	10	N/A	15	N/A	105
40	140	20	TSP20147M040A(3)(7)035(9)543	560	10	20	N/A	N/A	105
50	94	20	TSP20946M050A(3)(7)060(9)543	470	10	35	N/A	N/A	105
63	44	20	TSP20446M063A(3)(7)040(9)543	277	10	25	N/A	N/A	105
63	44	20	TSP20446M063A(3)(7)030(9)543	277	10	N/A	20	N/A	105

((1) To complete KEMET part number, insert 65 = 4 cycles +25°C, 66 = 10 cycles +25°C, 67 = 10 cycles -55°C +85°C, 85 = 4 cycles + 25°C + improved humidity, 86 = 10 cycles +25°C +improved humidity,

87 = 10 cycles +55°C and +85°C + improved humidity. Designates surge current option

(2) To complete KEMET part number, insert 05= High ESR, 10 = Standard ESR, 20 = Low ESR. Designates ESR option.

(3) To complete KEMET part number, insert H = Standard solder coated or T = 100% Tin

(4) To complete KEMET part number, insert M for ±20%, K for ±10%. Designates Capacitance tolerance.

(5) To complete KEMET part number, insert D = Silver-plated (Ag), H = Solder-plated, or T = 100% Tin (Sn). Designates Termination Finish (stack)

(6) To complete KEMET part number, insert D (0.001%/1,000 hours), C (0.01%/1,000 hours), B (0.1%/1,000 hours), or A = N/A. Designates Reliability Level.

(7) To complete KEMET part number, insert E = None, S = 10 cycles at +25°C, W = 10 cycles -55°C and +85°C. Designates surge current option for T543 discrete component

(8) To complete KEMET part number, C (0.01%/1,000 hours), B (0.1%/1,000 hours), or A = N/A. Designates Reliability Level.

(9) To complete KEMET part number, insert D = Silver-plated (Ag), H = Solder-plated, T = 100% Tin (Sn) or X = Leadless stack.

Please contact your sales representative for availability of engineering samples.

Part numbers marked in blue font are under development.

Table 1B – TSP3 Ratings & Part Number Reference

Rated Voltage	Rated Capacitance	Case Code/ Case Size	KEMET Part Number	DC Leakage	DF	Standard ESR	Low ESR	Maximum Operating Temp
VDC at 105°C	µF	KEMET/EIA	(See below for part options)	µA at +25°C Max/5 Min	% at +25°C 120 Hz Max	mΩ at +25°C 100 kHz Max	mΩ at +25°C 100 kHz Max	°C
3	450	3B	TSP3B457(4)003(6)(3)(1)10(5)540	135	8	27	N/A	125
4	300	3B	TSP3B307(4)004(6)(3)(1)10(5)540	120	8	27	N/A	125
6.3	200	3B	TSP3B207(4)006(6)(3)(1)10(5)540	129	8	27	N/A	125
10	99	3B	TSP3B996(4)010(6)(3)(1)10(5)540	99	8	27	N/A	125
3	2,000	3D	TSP3D208(4)003(6)(3)(1)10(5)540	612	10	9	N/A	125
4	1,400	3D	TSP3D148(4)004(6)(3)(1)(2)(5)540	564	10	14	9	125
6.3	990	3D	TSP3D997(4)006(6)(3)(1)(2)(5)540	624	10	14	9	125
10	660	3D	TSP3D667(4)010(6)(3)(1)10(5)540	660	10	9	N/A	125
16	140	3D	TSP3D147(4)016(6)(3)(1)(2)(5)540	226	10	22	12	125
4	2,000	3X	TSP3X208(4)004(6)(3)(1)(2)(5)541	800	10	3	2	125
4	3,000	3X	TSP3X308(4)004(6)(3)(1)(2)(5)541	1,200	10	3	2	125
6.3	1,400	3X	TSP3X148(4)006(6)(3)(1)(2)(5)541	840	10	3	2	125
10	990	3X	TSP3X997(4)010(8)(3)(1)(2)(5)541	990	10	3	2	125
16	450	3X	TSP3X457(4)016(6)(3)(1)(2)(5)541	720	10	15	9	125
16	660	3X	TSP3X667(4)016(6)(3)(1)(2)(5)541	1,056	10	15	9	125
16	990	3X	TSP3X997(4)016(6)(3)(1)(2)(5)541	1,584	10	18	9	125
25	200	3X	TSP3X207(4)025(6)(3)(1)10(5)541	500	10	18	N/A	125
35	100	3X	TSP3X107(4)035(8)(3)(1)10(5)541	350	10	20	N/A	125
35	140	3X	TSP3X147(4)035(8)(3)(1)10(5)541	490	10	20	N/A	125
50	66	3X	TSP3X666(4)050(8)(3)(1)10(5)541	330	10	25	N/A	125
50	100	3X	TSP3X107(4)050(8)(3)(1)10(5)541	500	10	25	N/A	125
63	30	3X	TSP3X306(4)063(8)(3)(1)(2)(5)541	189	10	50	35	125
63	45	3X	TSP3X456(4)063(8)(3)(1)10(5)541	283.5	10	18	N/A	125

(1) To complete KEMET part number, insert 65 = 4 cycles +25°C, 66 = 10 cycles +25°C, 67 = 10 cycles -55°C +85°C, 85 = 4 cycles + 25°C + improved humidity, 86 = 10 cycles +25°C +improved humidity,

87 = 10 cycles +55°C and +85°C + improved humidity. Designates surge current option

(2) To complete KEMET part number, insert 05= High ESR, 10 = Standard ESR, 20 = Low ESR. Designates ESR option.

(3) To complete KEMET part number, insert H = Standard solder coated or T = 100% Tin

(4) To complete KEMET part number, insert M for ±20%, K for ±10%. Designates Capacitance tolerance.

(5) To complete KEMET part number, insert D = Silver-plated (Ag), H = Solder-plated, or T = 100% Tin (Sn). Designates Termination Finish (stack)

(6) To complete KEMET part number, insert D (0.001%/1,000 hours), C (0.01%/1,000 hours), B (0.1%/1,000 hours), or A = N/A. Designates Reliability Level.

(7) To complete KEMET part number, insert E = None, S = 10 cycles at +25°C, W = 10 cycles -55°C and +85°C. Designates surge current option for T543 discrete component

(8) To complete KEMET part number, C (0.01%/1,000 hours), B (0.1%/1,000 hours), or A = N/A. Designates Reliability Level.

(9) To complete KEMET part number, insert D = Silver-plated (Ag), H = Solder-plated, T = 100% Tin (Sn) or X = Leadless stack.

Please contact your sales representative for availability of engineering samples.

Table 1B – TSP3 Ratings & Part Number Reference

Rated Voltage	Rated Capacitance	Case Code/ Case Size	KEMET Part Number	DC Leakage	DF	Standard ESR	Low ESR	Maximum Operating Temp
VDC at 105°C	µF	KEMET/EIA	(See below for part options)	µA at +25°C Max/5 Min	% at +25°C 120 Hz Max	mΩ at +25°C 100 kHz Max	mΩ at +25°C 100 kHz Max	°C
3	6,000	30	TSP30608M003(6)(3)(1)10(9)541	1,800	10	5	N/A	125
4	4,500	30	TSP30458M004(6)(3)(1)10(9)541	1,800	10	5	N/A	125
6.3	3,000	30	TSP30308M006(6)(3)(1)10(9)541	1,890	10	6	N/A	125
10	2,000	30	TSP30208M010(6)(3)(1)10(9)541	2,040	10	7	N/A	125
16	1,400	30	TSP30148M016(6)(3)(1)(2)(9)541	2,256	10	15	9	125
25	450	30	TSP30457M025(6)(3)(1)10(9)541	1,125	10	17	N/A	125
30	450	30	TSP30457M030(6)(3)(1)(2)(9)541	1,350	10	20	12	125
35	130	30	TSP30137M035(6)(3)(1)10(9)541	714	10	17	N/A	125
50	94	30	TSP30946M050(6)(3)(1)10(9)541	705	10	22	N/A	125
3	6,000	30	TSP30608M003A(3)(7)010(9)543	1,800	10	5	N/A	105
4	4,500	30	TSP30458M004A(3)(7)010(9)543	1,800	10	5	N/A	105
6.3	3,000	30	TSP30308M006A(3)(7)010(9)543	1,890	10	8	N/A	105
6.3	3,000	30	TSP30308M006A(3)(7)015(9)543	1,890	10	7	N/A	105
10	2,000	30	TSP30208M010A(3)(7)015(9)543	2,040	10	7	N/A	105
16	1,400	30	TSP30148M016A(3)(7)020(9)543	2,256	10	9	N/A	105
16	1,400	30	TSP30148M016A(3)(7)040(9)543	2,256	10	15	N/A	105
25	450	30	TSP30457M025A(3)(7)045(9)543	1,125	10	17	N/A	105
30	450	30	TSP30457M030A(3)(7)030(9)543	1350	10	12	N/A	105
30	450	30	TSP30457M030A(3)(7)045(9)543	1350	10	17	N/A	105
30	450	30	TSP30457M030A(3)(7)055(9)543	1350	10	20	N/A	105
35	200	30	TSP30207M035A(3)(7)025(9)543	714	10	10	N/A	105
35	200	30	TSP30207M035A(3)(7)045(9)543	714	10	17	N/A	105
40	200	30	TSP30207M040A(3)(7)035(9)543	816	10	14	N/A	105
40	240	30	TSP30247M040A(3)(7)055(9)543	984	10	20	N/A	105
50	140	30	TSP30147M050A(3)(7)060(9)543	705	10	22	N/A	105

- (1) To complete KEMET part number, insert 65 = 4 cycles +25°C, 66 = 10 cycles +25°C, 67 = 10 cycles -55°C +85°C, 85 = 4 cycles + 25°C + improved humidity, 86 = 10 cycles +25°C +improved humidity, 87 = 10 cycles +55°C and +85°C + improved humidity. Designates surge current option
- (2) To complete KEMET part number, insert 05= High ESR ,10 = Standard ESR, 20 = Low ESR. Designates ESR option.
- (3) To complete KEMET part number, insert H = Standard solder coated or T = 100% Tin
- (4) To complete KEMET part number, insert M for ±20%, K for ±10%. Designates Capacitance tolerance.
- (5) To complete KEMET part number, insert D = Silver-plated (Ag) , H = Solder-plated, or T = 100% Tin (Sn). Designates Termination Finish (stack)
- (6) To complete KEMET part number, insert D (0.001%/1,000 hours), C (0.01%/1,000 hours), B (0.1%/1,000 hours), or A = N/A. Designates Reliability Level.
- (7) To complete KEMET part number, insert E = None, S = 10 cycles at +25°C, W = 10 cycles -55°C and +85°C. Designates surge current option for T543 discrete component
- (8) To complete KEMET part number, C (0.01%/1,000 hours), B (0.1%/1,000 hours), or A = N/A. Designates Reliability Level.
- (9) To complete KEMET part number, insert D = Silver-plated (Ag) , H = Solder-plated, T = 100% Tin (Sn) or X = Leadless stack.
- Please contact your sales representative for availability of engineering samples.

Table 1C – TSP4 Ratings & Part Number Reference

Rated Voltage	Rated Capacitance	Case Code/ Case Size	KEMET Part Number	DC Leakage	DF	Standard ESR	Low ESR	Ultra Low ESR	Maximum Operating Temp
VDC at 105°C	µF	KEMET/EIA	(See below for part options)	µA at +25°C Max/5 Min	% at +25°C 120 Hz Max	mΩ at +25°C 100 kHz Max	mΩ at +25°C 100 kHz Max	mΩ at +25°C 100 kHz Max	°C
3	600	4B	TSP4B607(4)003(6)(3)(1)(10)(5)540	180	8	20	N/A	N/A	125
4	400	4B	TSP4B407(4)004(6)(3)(1)(10)(5)540	160	8	20	N/A	N/A	125
6.3	270	4B	TSP4B277(4)006(6)(3)(1)(10)(5)540	172	8	20	N/A	N/A	125
10	130	4B	TSP4B137(4)010(6)(3)(1)(10)(5)540	132	8	20	N/A	N/A	125
3	2,700	4D	TSP4D278(4)003(6)(3)(1)(10)(5)540	816	10	7	N/A	N/A	125
4	880	4D	TSP4D887(4)004(6)(3)(1)(10)(5)540	352	10	7	N/A	N/A	125
4	1,900	4D	TSP4D198(4)004(6)(3)(1)(2)(5)540	752	10	10	7	N/A	125
6.3	1,300	4D	TSP4D138(4)006(6)(3)(1)(2)(5)540	832	10	10	7	N/A	125
10	400	4D	TSP4D407(4)010(6)(3)(1)(2)(5)540	400	10	14	7	N/A	125
10	880	4D	TSP4D887(4)010(6)(3)(1)(10)(5)540	880	10	7	N/A	N/A	125
16	190	4D	TSP4D197(4)016(6)(3)(1)(2)(5)540	301	10	17	9	N/A	125
4	2,700	4X	TSP4X278(4)004(6)(3)(1)(2)(5)541	1,080	10	3	2	N/A	125
4	4,000	4X	TSP4X408(4)004(6)(3)(1)(2)(5)541	1,600	10	3	2	N/A	125
6.3	1,900	4X	TSP4X198(4)006(6)(3)(1)(2)(5)541	1,140	10	3	2	N/A	125
10	1,300	4X	TSP4X138(4)010(8)(3)(1)(2)(5)541	1,300	10	3	2	N/A	125
16	600	4X	TSP4X607(4)016(6)(3)(1)(2)(5)541	960	10	10	8	N/A	125
16	880	4X	TSP4X887(4)016(6)(3)(1)(2)(5)541	1,408	10	10	8	N/A	125
16	1,300	4X	TSP4X138(4)016(6)(3)(1)(2)(5)541	2,080	10	12	8	N/A	125
25	260	4X	TSP4X267(4)025(6)(3)(1)(10)(5)541	650	10	12	N/A	N/A	125
35	130	4X	TSP4X137(4)035(8)(3)(1)(10)(5)541	455	10	15	N/A	N/A	125
35	190	4X	TSP4X197(4)035(8)(3)(1)(10)(5)541	665	10	15	N/A	N/A	125
50	88	4X	TSP4X886(4)050(8)(3)(1)(10)(5)541	440	10	20	N/A	N/A	125
50	130	4X	TSP4X137(4)050(8)(3)(1)(10)(5)541	650	10	20	N/A	N/A	125
63	40	4X	TSP4X406(4)063(8)(3)(1)(2)(5)541	252	10	40	25	N/A	125
63	60	4X	TSP4X606(4)063(8)(3)(1)(10)(5)541	378	10	12	N/A	N/A	125

- (1) To complete KEMET part number, insert 65 = 4 cycles +25°C, 66 = 10 cycles +25°C, 67 = 10 cycles -55°C +85°C, 85 = 4 cycles + 25°C + improved humidity, 86 = 10 cycles +25°C +improved humidity, 87 = 10 cycles +55°C and +85°C + improved humidity. Designates surge current option
- (2) To complete KEMET part number, insert 05= High ESR, 10 = Standard ESR, 20 = Low ESR. Designates ESR option.
- (3) To complete KEMET part number, insert H = Standard solder coated or T = 100% Tin
- (4) To complete KEMET part number, insert M for ±20%, K for ±10%. Designates Capacitance tolerance.
- (5) To complete KEMET part number, insert D = Silver-plated (Ag), H = Solder-plated, or T = 100% Tin (Sn). Designates Termination Finish (stack)
- (6) To complete KEMET part number, insert D (0.001%/1,000 hours), C (0.01%/1,000 hours), B (0.1%/1,000 hours), or A = N/A. Designates Reliability Level.
- (7) To complete KEMET part number, insert E = None, S = 10 cycles at +25°C, W = 10 cycles -55°C and +85°C. Designates surge current option for T543 discrete component
- (8) To complete KEMET part number, C (0.01%/1,000 hours), B (0.1%/1,000 hours), or A = N/A. Designates Reliability Level.
- (9) To complete KEMET part number, insert D = Silver-plated (Ag), H = Solder-plated, T = 100% Tin (Sn) or X = Leadless stack.
- Please contact your sales representative for availability of engineering samples.

Table 1C – TSP4 Ratings & Part Number Reference cont.

Rated Voltage	Rated Capacitance	Case Code/ Case Size	KEMET Part Number	DC Leakage	DF	Standard ESR	Low ESR	Ultra Low ESR	Maximum Operating Temp
VDC at 105°C	µF	KEMET/EIA	(See below for part options)	µA at +25°C Max/5 Min	% at +25°C 120 Hz Max	mΩ at +25°C 100 kHz Max	mΩ at +25°C 100 kHz Max	mΩ at +25°C 100 kHz Max	°C
3	8,000	40	TSP40808M003(6)(3)(1)10(9)541	2,400	10	5	N/A	N/A	125
4	6,000	40	TSP40608M004(6)(3)(1)10(9)541	2,400	10	5	N/A	N/A	125
6.3	4,000	40	TSP40408M006(6)(3)(1)10(9)541	2,520	10	5	N/A	N/A	125
10	2,700	40	TSP40278M010(6)(3)(1)10(9)541	2,700	10	6	N/A	N/A	125
16	1,900	40	TSP40198M016(6)(3)(1)2(9)541	3,040	10	15	7	N/A	125
25	600	40	TSP40607M025(6)(3)(1)10(9)541	1,500	10	15	N/A	N/A	125
30	600	40	TSP40607M030(8)(3)(1)2(9)541	1,800	10	20	10	N/A	125
35	270	40	TSP40277M035(8)(3)(1)10(9)541	952	10	15	N/A	N/A	125
50	190	40	TSP40197M050(8)(3)(1)10(9)541	950	10	20	N/A	N/A	125
63	88	40	TSP40886M063(8)(3)(1)10(9)541	554	10	15	N/A	N/A	125
3	8,000	40	TSP40808M003A(3)(7)010(9)543	2,400	10	5	N/A	N/A	105
4	6,000	40	TSP40608M004A(3)(7)010(9)543	2,400	10	5	N/A	N/A	105
6.3	4,000	40	TSP40408M006A(3)(7)015(9)543	2,520	10	6	N/A	N/A	105
6.3	4,000	40	TSP40408M006A(3)(7)010(9)543	2,520	10	N/A	5	N/A	105
10	2,700	40	TSP40278M010A(3)(7)010(9)543	2,700	10	6	N/A	N/A	105
16	1,900	40	TSP40198M016A(3)(7)040(9)543	3,040	10	15	N/A	N/A	105
16	1,900	40	TSP40198M016A(3)(7)020(9)543	3,040	10	N/A	7	N/A	105
25	600	40	TSP40607M025A(3)(7)045(9)543	1,500	10	15	N/A	N/A	105
30	600	40	TSP40607M030A(3)(7)055(9)543	1,800	10	20	N/A	N/A	105
30	600	40	TSP40607M030A(3)(7)045(9)543	1,800	10	N/A	15	N/A	105
30	600	40	TSP40607M030A(3)(7)030(9)543	1,800	10	N/A	N/A	10	105
35	270	40	TSP40277M035A(3)(7)045(9)543	952	10	15	N/A	N/A	105
35	270	40	TSP40277M035A(3)(7)025(9)543	952	10	N/A	8	N/A	105
40	270	40	TSP40277M040A(3)(7)035(9)543	1,080	10	15	N/A	N/A	105
50	190	40	TSP40197M050A(3)(7)060(9)543	950	10	20	N/A	N/A	105
63	88	40	TSP40886M063A(3)(7)040(9)543	554	10	15	N/A	N/A	105
63	88	40	TSP40886M063A(3)(7)030(9)543	554	10	N/A	10	N/A	105

- (1) To complete KEMET part number, insert 65 = 4 cycles +25°C, 66 = 10 cycles +25°C, 67 = 10 cycles -55°C +85°C, 85 = 4 cycles + 25°C + improved humidity, 86 = 10 cycles +25°C +improved humidity, 87 = 10 cycles +55°C and +85°C + improved humidity. Designates surge current option
- (2) To complete KEMET part number, insert 05= High ESR, 10 = Standard ESR, 20 = Low ESR. Designates ESR option.
- (3) To complete KEMET part number, insert H = Standard solder coated or T = 100% Tin
- (4) To complete KEMET part number, insert M for ±20%, K for ±10%. Designates Capacitance tolerance.
- (5) To complete KEMET part number, insert D = Silver-plated (Ag), H = Solder-plated, or T = 100% Tin (Sn). Designates Termination Finish (stack)
- (6) To complete KEMET part number, insert D (0.001%/1,000 hours), C (0.01%/1,000 hours), B (0.1%/1,000 hours), or A = N/A. Designates Reliability Level.
- (7) To complete KEMET part number, insert E = None, S = 10 cycles at +25°C, W = 10 cycles -55°C and +85°C. Designates surge current option for T543 discrete component
- (8) To complete KEMET part number, C (0.01%/1,000 hours), B (0.1%/1,000 hours), or A = N/A. Designates Reliability Level.
- (9) To complete KEMET part number, insert D = Silver-plated (Ag), H = Solder-plated, T = 100% Tin (Sn) or X = Leadless stack.
- Please contact your sales representative for availability of engineering samples.

Part numbers marked in blue font are under development.

Table 1D – TSP6 Ratings & Part Number Reference

Rated Voltage	Rated Capacitance	Case Code/ Case Size	KEMET Part Number	DC Leakage	DF	Standard ESR	Low ESR	Maximum Operating Temp
VDC at 105°C	µF	KEMET/EIA	(See below for part options)	µA at +25°C Max/5 Min	% at +25°C 120 Hz Max	mΩ at +25°C 100 kHz Max	mΩ at +25°C 100 kHz Max	°C
3	900	6B	TSP6B907(4)003(6)(3)(1)10(5)540	270	8	14	N/A	125
4	600	6B	TSP6B607(4)004(6)(3)(1)10(5)540	240	8	14	N/A	125
6.3	400	6B	TSP6B407(4)006(6)(3)(1)10(5)540	258	8	14	N/A	125
10	200	6B	TSP6B207(4)010(6)(3)(1)10(5)540	198	8	14	N/A	125
3	4,100	6D	TSP6D418(4)003(6)(3)(1)10(5)540	1,224	10	5	N/A	125
4	2,800	6D	TSP6D288(4)004(6)(3)(1)(2)(5)540	1,128	10	7	5	125
6.3	2,000	6D	TSP6D208(4)006(6)(3)(1)(2)(5)540	1,248	10	7	5	125
10	900	6D	TSP6D907(4)010(6)(3)(1)(2)(5)540	900	10	10	5	125
10	1,300	6D	TSP6D138(4)010(6)(3)(1)10(5)540	1,320	10	5	N/A	125
16	280	6D	TSP6D287(4)016(6)(3)(1)(2)(5)540	452	10	11	6	125
4	4,000	6X	TSP6X408(4)004(6)(3)(1)(2)(5)541	1,600	10	2	1	125
4	6,000	6X	TSP6X608(4)004(6)(3)(1)(2)(5)541	2,400	10	2	1	125
6.3	2,800	6X	TSP6X288(4)006(6)(3)(1)(2)(5)541	1,680	10	2	1	125
10	2,000	6X	TSP6X208(4)010(8)(3)(1)(2)(5)541	2,000	10	2	1	125
16	900	6X	TSP6X907(4)016(6)(3)(1)(2)(5)541	1,440	10	8	5	125
16	1,300	6X	TSP6X138(4)016(6)(3)(1)(2)(5)541	2,080	10	8	5	125
16	2,000	6X	TSP6X208(4)016(6)(3)(1)(2)(5)541	3,200	10	9	5	125
25	400	6X	TSP6X407(4)025(6)(3)(1)10(5)541	1,000	10	9	N/A	125
35	200	6X	TSP6X207(4)035(8)(3)(1)10(5)541	700	10	10	N/A	125
35	280	6X	TSP6X287(4)035(8)(3)(1)10(5)541	980	10	10	N/A	125
50	130	6X	TSP6X137(4)050(8)(3)(1)10(5)541	650	10	12	N/A	125
50	200	6X	TSP6X207(4)050(8)(3)(1)10(5)541	1,000	10	12	N/A	125
63	60	6X	TSP6X606(4)063(8)(3)(1)(2)(5)541	378	10	25	20	125
63	90	6X	TSP6X906(4)063(8)(3)(1)10(5)541	567	10	9	N/A	125

(1) To complete KEMET part number, insert 65 = 4 cycles +25°C, 66 = 10 cycles +25°C, 67 = 10 cycles -55°C +85°C, 85 = 4 cycles + 25°C + improved humidity, 86 = 10 cycles +25°C +improved humidity,

87 = 10 cycles +55°C and +85°C + improved humidity. Designates surge current option

(2) To complete KEMET part number, insert 05= High ESR, 10 = Standard ESR, 20 = Low ESR. Designates ESR option.

(3) To complete KEMET part number, insert H = Standard solder coated or T = 100% Tin

(4) To complete KEMET part number, insert M for ±20%, K for ±10%. Designates Capacitance tolerance.

(5) To complete KEMET part number, insert D = Silver-plated (Ag) , H = Solder-plated, or T = 100% Tin (Sn). Designates Termination Finish (stack)

(6) To complete KEMET part number, insert D (0.001%/1,000 hours), C (0.01%/1,000 hours), B (0.1%/1,000 hours), or A = N/A. Designates Reliability Level.

(7) To complete KEMET part number, insert E = None, S = 10 cycles at +25°C, W = 10 cycles -55°C and +85°C. Designates surge current option for T543 discrete component

(8) To complete KEMET part number, C (0.01%/1,000 hours), B (0.1%/1,000 hours), or A = N/A. Designates Reliability Level.

(9) To complete KEMET part number, insert D = Silver-plated (Ag) , H = Solder-plated, T = 100% Tin (Sn) or X = Leadless stack.

Please contact your sales representative for availability of engineering samples.

Table 1D – TSP6 Ratings & Part Number Reference

Rated Voltage	Rated Capacitance	Case Code/ Case Size	KEMET Part Number	DC Leakage	DF	Standard ESR	Low ESR	Maximum Operating Temp
VDC at 105°C	µF	KEMET/EIA	(See below for part options)	µA at +25°C Max/5 Min	% at +25°C 120 Hz Max	mΩ at +25°C 100 kHz Max	mΩ at +25°C 100 kHz Max	°C
3	12,000	60	TSP60129M003(8)(3)(1)10(9)541	3,600	10	4	N/A	125
4	9,000	60	TSP60908M004(8)(3)(1)10(9)541	3,600	10	4	N/A	125
6.3	6,000	60	TSP60608M006(8)(3)(1)10(9)541	3,780	10	4	N/A	125
10	4,000	60	TSP60408M010(8)(3)(1)10(9)541	4,080	10	5	N/A	125
16	2,800	60	TSP60288M016(8)(3)(1)(2)(9)541	4,512	10	9	5	125
25	900	60	TSP60907M025(8)(3)(1)10(9)541	2,250	10	10	N/A	125
30	900	60	TSP60907M030(8)(3)(1)(2)(9)541	2,700	10	11	7	125
35	400	60	TSP60407M035(8)(3)(1)10(9)541	1,428	10	10	N/A	125
50	280	60	TSP60287M050(8)(3)(1)10(9)541	1,410	10	12	N/A	125
3	12,000	60	TSP60129M003A(3)(7)010(9)543	3,600	10	4	N/A	105
4	9,000	60	TSP60908M004A(3)(7)010(9)543	3,600	10	4	N/A	105
6.3	6,000	60	TSP60608M006A(3)(7)010(9)543	3,780	10	4	N/A	105
6.3	6,000	60	TSP60608M006A(3)(7)015(9)543	3,780	10	5	N/A	105
10	4,000	60	TSP60408M010A(3)(7)015(9)543	4,080	10	5	N/A	105
16	2,800	60	TSP60288M016A(3)(7)020(9)543	4,512	10	5	N/A	105
16	2,800	60	TSP60288M016A(3)(7)040(9)543	4,512	10	9	N/A	105
25	900	60	TSP60907M025A(3)(7)045(9)543	2,250	10	10	N/A	105
30	900	60	TSP60907M030A(3)(7)030(9)543	2,700	10	7	N/A	105
30	900	60	TSP60907M030A(3)(7)045(9)543	2,700	10	10	N/A	105
30	900	60	TSP60907M030A(3)(7)055(9)543	2,700	10	11	N/A	105
35	400	60	TSP60407M035A(3)(7)025(9)543	1,428	10	6	N/A	105
35	400	60	TSP60407M035A(3)(7)035(9)543	1,428	10	8	N/A	105
35	400	60	TSP60407M035A(3)(7)045(9)543	1,428	10	10	N/A	105
40	480	60	TSP60487M040A(3)(7)055(9)543	1,968	10	11	N/A	105
50	280	60	TSP60287M050A(3)(7)060(9)543	1,410	10	12	N/A	105

- (1) To complete KEMET part number, insert 65 = 4 cycles +25°C, 66 = 10 cycles +25°C, 67 = 10 cycles -55°C +85°C, 85 = 4 cycles + 25°C + improved humidity, 86 = 10 cycles +25°C +improved humidity, 87 = 10 cycles +55°C and +85°C + improved humidity. Designates surge current option
- (2) To complete KEMET part number, insert 05= High ESR, 10 = Standard ESR, 20 = Low ESR. Designates ESR option.
- (3) To complete KEMET part number, insert H = Standard solder coated or T = 100% Tin
- (4) To complete KEMET part number, insert M for ±20%, K for ±10%. Designates Capacitance tolerance.
- (5) To complete KEMET part number, insert D = Silver-plated (Ag), H = Solder-plated, or T = 100% Tin (Sn). Designates Termination Finish (stack)
- (6) To complete KEMET part number, insert D (0.001%/1,000 hours), C (0.01%/1,000 hours), B (0.1%/1,000 hours), or A = N/A. Designates Reliability Level.
- (7) To complete KEMET part number, insert E = None, S = 10 cycles at +25°C, W = 10 cycles -55°C and +85°C. Designates surge current option for T543 discrete component
- (8) To complete KEMET part number, C (0.01%/1,000 hours), B (0.1%/1,000 hours), or A = N/A. Designates Reliability Level.
- (9) To complete KEMET part number, insert D = Silver-plated (Ag), H = Solder-plated, T = 100% Tin (Sn) or X = Leadless stack.
- Please contact your sales representative for availability of engineering samples.

Derating Guidelines

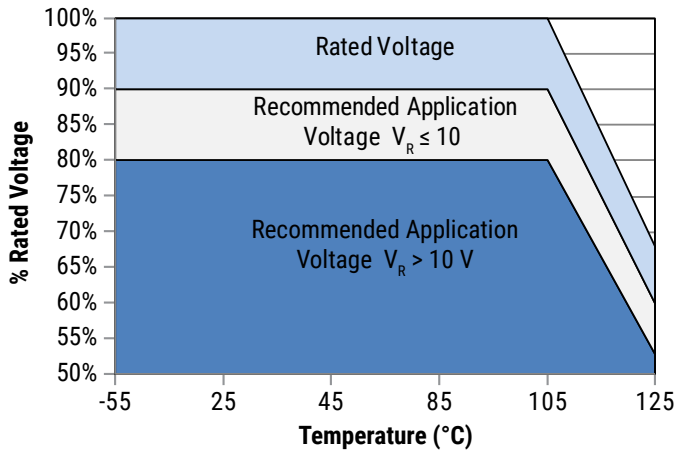

Recommended Application Voltage

KO-CAPs are solid state capacitors that demonstrate no wearout mechanism when operated within their recommended guidelines. While the KO-CAP can be operated at full rated voltage, most circuit designers seek a minimum level of assurance in long term reliability, which should be demonstrated with data. A voltage derating can provide the desired level of demonstrated reliability based on industry accepted acceleration models. Since most applications do require long term reliability, KEMET recommends that designers consider a voltage derating, according the graphic above, for the maximum steady state voltage.

Voltage Rating	Maximum Recommended Steady State Voltage	
	-55°C to 105°C	105°C to 125°C
$10 \text{ V} \leq V_R$	90% of V_R	90% of V_R , See Chart
$V_R > 10$	80% of V_R	54% of V_R , See Chart

V_R = Rated Voltage

Reverse Voltage

Solid electrolytic capacitors are polar devices and may be permanently damaged or destroyed if connected with the wrong polarity. The positive terminal is identified on the capacitor body by a stripe plus in some cases a beveled edge. A small degree of transient reverse voltage is permissible for short periods per the table. The capacitors should not be operated continuously in reverse mode, even within these limits.

Temperature	Permissible Transient Reverse Voltage
25°C	15% of Rated Voltage
85°C	5% of Rated Voltage
125°C	1% of Rated Voltage

Table 2 – Land Dimensions/Courtyard

KEMET	Density Level A: Maximum (Most) Land Protrusion (mm)					Density Level B: Median (Nominal) Land Protrusion (mm)					Density Level C: Minimum (Least) Land Protrusion (mm)				
	L	W	S	V1	V2	L	W	S	V1	V2	L	W	S	V1	V2
TSP2B	2.34	2.54	1.41	7.10	4.30	1.94	2.42	1.61	6.00	3.80	1.56	2.32	1.77	5.14	3.54
TSP2C	2.98	2.74	2.53	9.50	4.50	2.58	2.62	2.73	8.40	4.00	2.20	2.52	2.89	7.54	3.74
TSP2D	3.48	3.24	3.03	11.00	5.60	3.08	3.12	3.23	9.90	5.10	2.70	3.02	3.39	9.04	4.84
TSP2X	3.48	3.24	3.03	11.00	5.60	3.08	3.12	3.23	9.90	5.10	2.70	3.02	3.39	9.04	4.84
TSP2O	3.48	4.53	3.87	11.00	7.50	3.08	4.41	4.07	9.90	7.00	2.70	4.31	4.23	9.07	6.74
TSP3B	2.34	2.54	1.41	7.10	4.30	1.94	2.42	1.61	6.00	3.80	1.56	2.32	1.77	5.14	3.54
TSP3D	3.48	3.24	3.03	11.00	5.60	3.08	3.12	3.23	9.90	5.10	2.70	3.02	3.39	9.04	4.84
TSP3X	3.48	3.24	3.03	11.00	5.60	3.08	3.12	3.23	9.90	5.10	2.70	3.02	3.39	9.04	4.84
TSP3O	3.48	4.53	3.87	11.00	7.50	3.08	4.41	4.07	9.90	7.00	2.70	4.31	4.23	9.07	6.74
TSP4B	2.34	5.54	1.41	7.10	7.30	1.94	5.42	1.61	6.00	6.80	1.56	5.32	1.77	5.14	6.54
TSP4D	3.48	7.64	3.03	11.00	10.10	3.08	7.52	3.23	9.90	9.60	2.70	7.42	3.39	9.04	9.34
TSP4X	3.48	7.64	3.03	11.00	10.10	3.08	7.52	3.23	9.90	9.60	2.70	7.42	3.39	9.04	9.34
TSP4O	3.48	10.93	3.87	11.00	13.64	3.08	10.81	4.07	9.90	13.14	2.70	10.71	4.23	9.07	12.88
TSP6B	2.34	5.54	1.41	7.10	7.30	1.94	5.42	1.61	6.00	6.80	1.56	5.32	1.77	5.14	6.54
TSP6D	3.48	7.64	3.03	11.00	10.10	3.08	7.52	3.23	9.90	9.60	2.70	7.42	3.39	9.04	9.34
TSP6X	3.48	7.64	3.03	11.00	10.10	3.08	7.52	3.23	9.90	9.60	2.70	7.42	3.39	9.04	9.34
TSP6O	3.48	10.93	3.87	11.00	13.64	3.08	10.81	4.07	9.90	13.14	2.70	10.71	4.23	9.07	12.88

Density Level A: For low-density Product applications. Recommended for wave solder applications and provides a wider process window for reflow solder processes.

Density Level B: For products with a moderate level of component density. Provides a robust solder attachment condition for reflow solder processes.

Density Level C: For high component density product applications. Before adapting the minimum land pattern variations the user should perform qualification testing based on the conditions outlined in IPC standard 7351 (IPC-7351).

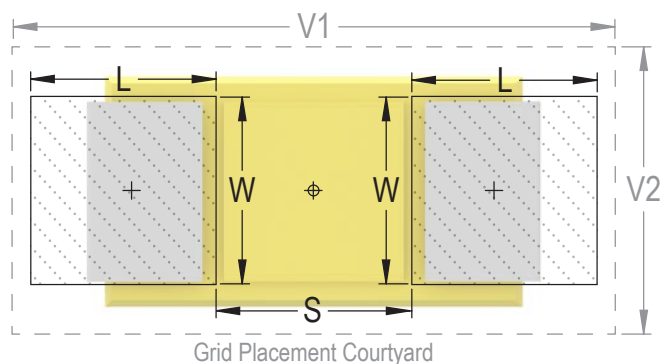

Soldering Process

KEMET’s families of surface mount capacitors are compatible with wave (single or dual), convection, IR, or vapor phase reflow techniques. Preheating of these components is recommended to avoid extreme thermal stress. KEMET’s recommended profile conditions for convection and IR reflow reflect the profile conditions of the IPC/J–STD–020D standard for moisture sensitivity testing. The devices can safely withstand a maximum of three reflow passes at these conditions.

Please note that although the X/7343–43 case size can withstand wave soldering, the tall profile (4.3 mm maximum) dictates care in wave process development.

Hand soldering should be performed with care due to the difficulty in process control. If performed, care should be taken to avoid contact of the soldering iron to the molded case. The iron should be used to heat the solder pad, applying solder between the pad and the termination, until reflow occurs. Once reflow occurs, the iron should be removed immediately. “Wiping” the edges of a chip and heating the top surface is not recommended.

Profile Feature	SnPb Assembly	Pb-Free Assembly
Preheat/Soak		
Temperature Minimum (T_{smin})	100°C	150°C
Temperature Maximum (T_{smax})	150°C	200°C
Time (t_s) from T_{smin} to T_{smax}	60 – 120 seconds	60 – 120 seconds
Ramp-up Rate (T_L to T_p)	3°C/seconds maximum	3°C/seconds maximum
Liquidous Temperature (T_L)	183°C	217°C
Time Above Liquidous (t_L)	60 – 150 seconds	60 – 150 seconds
Peak Temperature (T_p)	220°C	250°C
Time within 5°C of Maximum Peak Temperature (t_p)	20 seconds maximum	30 seconds maximum
Ramp-down Rate (T_p to T_L)	6°C/seconds maximum	6°C/seconds maximum
Time 25°C to Peak Temperature	6 minutes maximum	8 minutes maximum

Note: All temperatures refer to the center of the package, measured on the package body surface that is facing up during assembly reflow.

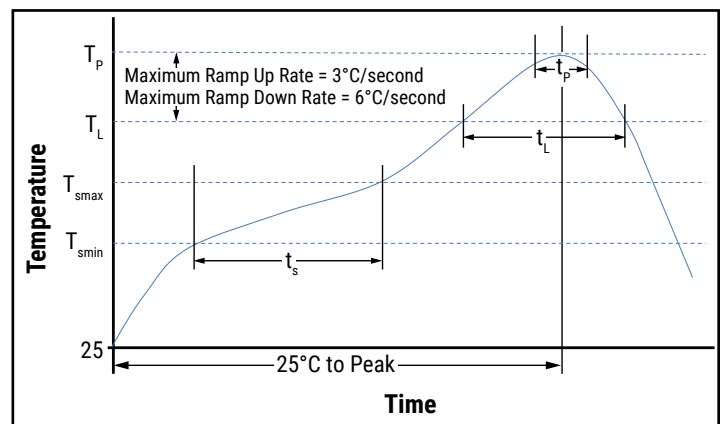

Storage

All KO-Cap Series are shipped in moisture barrier bags (MBBs) with desiccant and humidity indicator card (HIC). These parts are classified as MSL3 (Moisture Sensitivity Level 3) per IPC/JEDEC J–STD–020 and packaged per IPC/JEDEC J–STD–033

MSL3 specifies a floor time of 168H at 30°C maximum temperature and 60% relative humidity
Unused capacitors should be sealed in a MBB with fresh desiccant.

Calculated shelf life in sealed bag:

- 12 months from bag seal date in a storage environment of <40°C and humidity <90% RH
- 24 months from bag seal date in a storage environment of <30°C and humidity <70% RH

If baking is required, refer to IPC/JEDEC J–STD–033 for bake procedure

Packaging Information

KEMET Tantalum Stack Polymer (TSP) are packed in plastic trays
This packaging method is for manual board placement

Packaging Quantity

Case Code	Min pcs/tray	Max pcs/tray
2X	1	50
3X	1	50
4X	1	50
6X	1	50

X denotes the different stacks letter (B, C, D, X and O)

Construction- Leaded

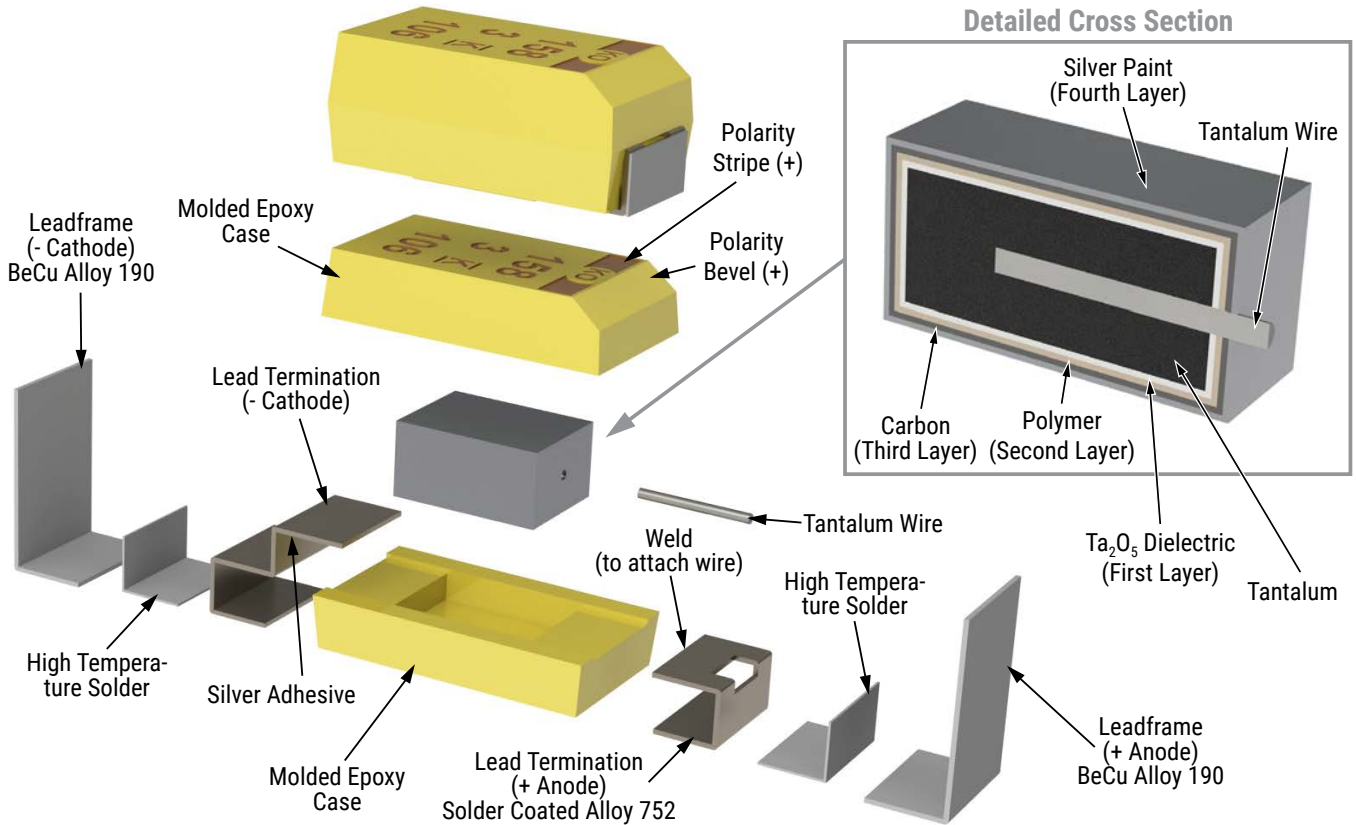

Construction- Leadless

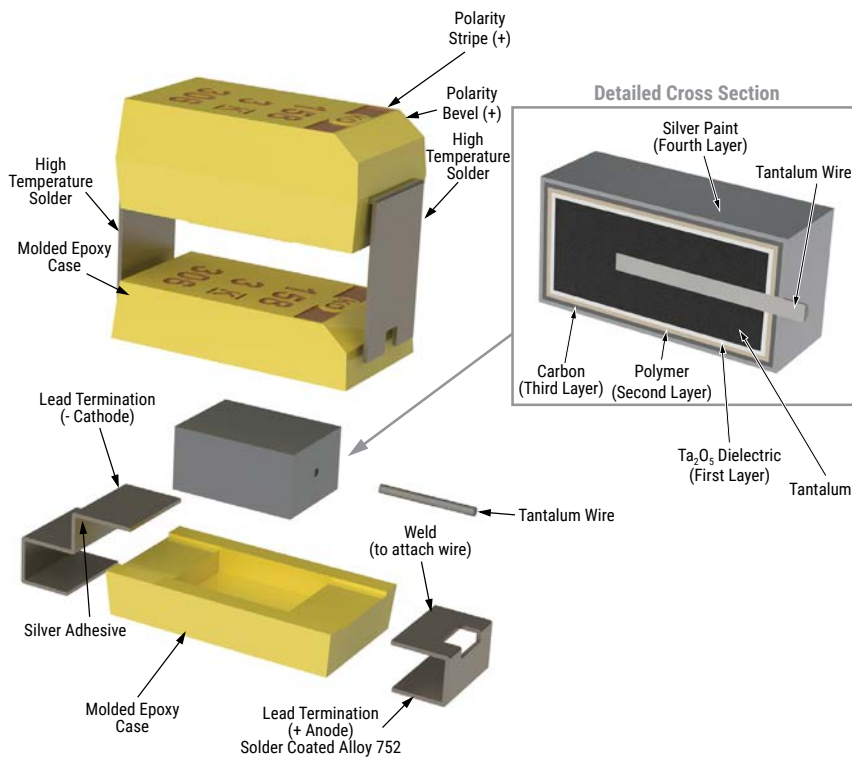

Marking (Discrete Capacitor)

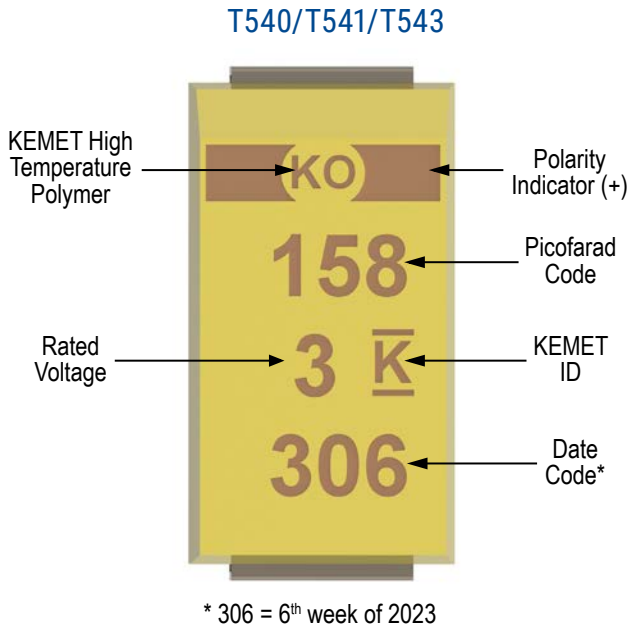

Date Code *	
1 st digit = Last number of Year	0 = 2020 1 = 2021 2 = 2022 3 = 2023 4 = 2024
2 nd and 3 rd digit = Week of the Year	01 = 1 st week of the Year to 52 = 52 nd week of the Year

NOTE: The marking observed is for the discrete capacitor used in the construction of the stacked product.

KEMET Electronics Corporation Sales Offices

For a complete list of our global sales offices, please visit www.kemet.com/sales.

Disclaimer

All product specifications, statements, information and data (collectively, the "Information") in this datasheet are subject to change. The customer is responsible for checking and verifying the extent to which the Information contained in this publication is applicable to an order at the time the order is placed. All Information given herein is believed to be accurate and reliable, but it is presented without guarantee, warranty, or responsibility of any kind, expressed or implied.

Statements of suitability for certain applications are based on KEMET Electronics Corporation's ("KEMET") knowledge of typical operating conditions for such applications, but are not intended to constitute – and KEMET specifically disclaims – any warranty concerning suitability for a specific customer application or use. The Information is intended for use only by customers who have the requisite experience and capability to determine the correct products for their application. Any technical advice inferred from this Information or otherwise provided by KEMET with reference to the use of KEMET's products is given gratis, and KEMET assumes no obligation or liability for the advice given or results obtained.

Although KEMET designs and manufactures its products to the most stringent quality and safety standards, given the current state of the art, isolated component failures may still occur. Accordingly, customer applications which require a high degree of reliability or safety should employ suitable designs or other safeguards (such as installation of protective circuitry or redundancies) in order to ensure that the failure of an electrical component does not result in a risk of personal injury or property damage.

Although all product-related warnings, cautions and notes must be observed, the customer should not assume that all safety measures are indicated or that other measures may not be required.

KEMET is a registered trademark of KEMET Electronics Corporation.