

# OSRAM KB DELPS2.D2

## Datasheet

Published by **ams-OSRAM AG**

Tobelbader Strasse 30, 8141 Premstaetten, Austria

Phone +43 3136 500-0

[ams-osram.com](http://ams-osram.com)

© All rights reserved



## TOPLED® E1608

# KB DELPS2.D2

The TOPLED E1608 expands ams-OSRAM's low power portfolio to meet the requirements in the field of illumination of switches and buttons in automotive interior applications. The TOPLED E1608 offers one of the smallest LED industry standard footprints in a highly reliable and well proved package concept. The TOPLED E1608 is available in different colors and brightness levels. Its outstanding performance is suitable for a huge variety of applications where a small package design with excellent reliability is needed.



## Applications

- Ambient Lighting
- Appliances & Tools
- Automotive Aftermarket

## Features

- Package: white SMT package, colored diffused silicone resin
- Chip technology: InGaN on Sapphire
- Typ. Radiation: 120° (Lambertian emitter)
- Color: Cx = 0.185, Cy = 0.17 acc. to CIE 1931 (• color on demand blue)
- Corrosion Robustness Class: 2B
- Qualifications: AEC-Q102 Qualified
- ESD: 2 kV acc. to ANSI/ESDA/JEDEC JS-001 (HBM, Class 2)

---

## Ordering Information

Type	Luminous Intensity <sup>1)</sup> $I_F = 5 \text{ mA}$ $I_v$	Ordering Code
KB DELPS2.D2-RHSI-2R6T-U515	130 ... 280 mcd	Q65112A9359

---

## Maximum Ratings

Parameter	Symbol		Values
Operating Temperature	$T_{op}$	min.	-40 °C
		max.	110 °C
Storage Temperature	$T_{stg}$	min.	-40 °C
		max.	110 °C
Junction Temperature	$T_j$	max.	125 °C
Forward current $T_s = 25\text{ °C}$	$I_F$	min.	1 mA
		max.	20 mA
Forward current pulsed $D = 0.005 ; T_s = 25\text{ °C}$	$I_{F\ pulse}$	max.	40 mA
Reverse voltage <sup>2)</sup> $T_s = 25\text{ °C}$	$V_R$	max.	5 V
ESD withstand voltage acc. to ANSI/ESDA/JEDEC JS-001 (HBM, Class 2)	$V_{ESD}$		2 kV

## Characteristics

$I_F = 5 \text{ mA}$ ;  $T_S = 25 \text{ °C}$

Parameter	Symbol		Values
Chromaticity Coordinate <sup>3)</sup>	C <sub>x</sub>	typ.	0.185
	C <sub>y</sub>	typ.	0.17
Viewing angle at 50% I <sub>v</sub>	2φ	typ.	120 °
Forward Voltage <sup>4)</sup> $I_F = 5 \text{ mA}$	V <sub>F</sub>	min.	2.50 V
		typ.	2.75 V
		max.	3.00 V
Reverse current <sup>2)</sup> $V_R = 5 \text{ V}$	I <sub>R</sub>	typ.	0.01 μA
		max.	10 μA
Real thermal resistance junction/ambient <sup>5)6)</sup>	R <sub>thJA real</sub>	max.	570 K / W
Real thermal resistance junction/solderpoint <sup>5)</sup>	R <sub>thJS real</sub>	typ.	120 K / W
		max.	210 K / W

## Brightness Groups

Group	Luminous Intensity <sup>1)</sup> $I_F = 5 \text{ mA}$ min. $I_v$	Luminous Intensity <sup>1)</sup> $I_F = 5 \text{ mA}$ max. $I_v$	Luminous Flux <sup>7)</sup> $I_F = 5 \text{ mA}$ typ. $\Phi_v$
RH	130 mcd	150 mcd	420 mlm
RI	150 mcd	180 mcd	500 mlm
SG	180 mcd	210 mcd	590 mlm
SH	210 mcd	240 mcd	680 mlm
SI	240 mcd	280 mcd	780 mlm

## Forward Voltage Groups

Group	Forward Voltage <sup>4)</sup> $I_F = 5 \text{ mA}$ min. $V_F$	Forward Voltage <sup>4)</sup> $I_F = 5 \text{ mA}$ max. $V_F$
U5	2.50 V	2.75 V
15	2.75 V	3.00 V

### Chromaticity Coordinate Groups

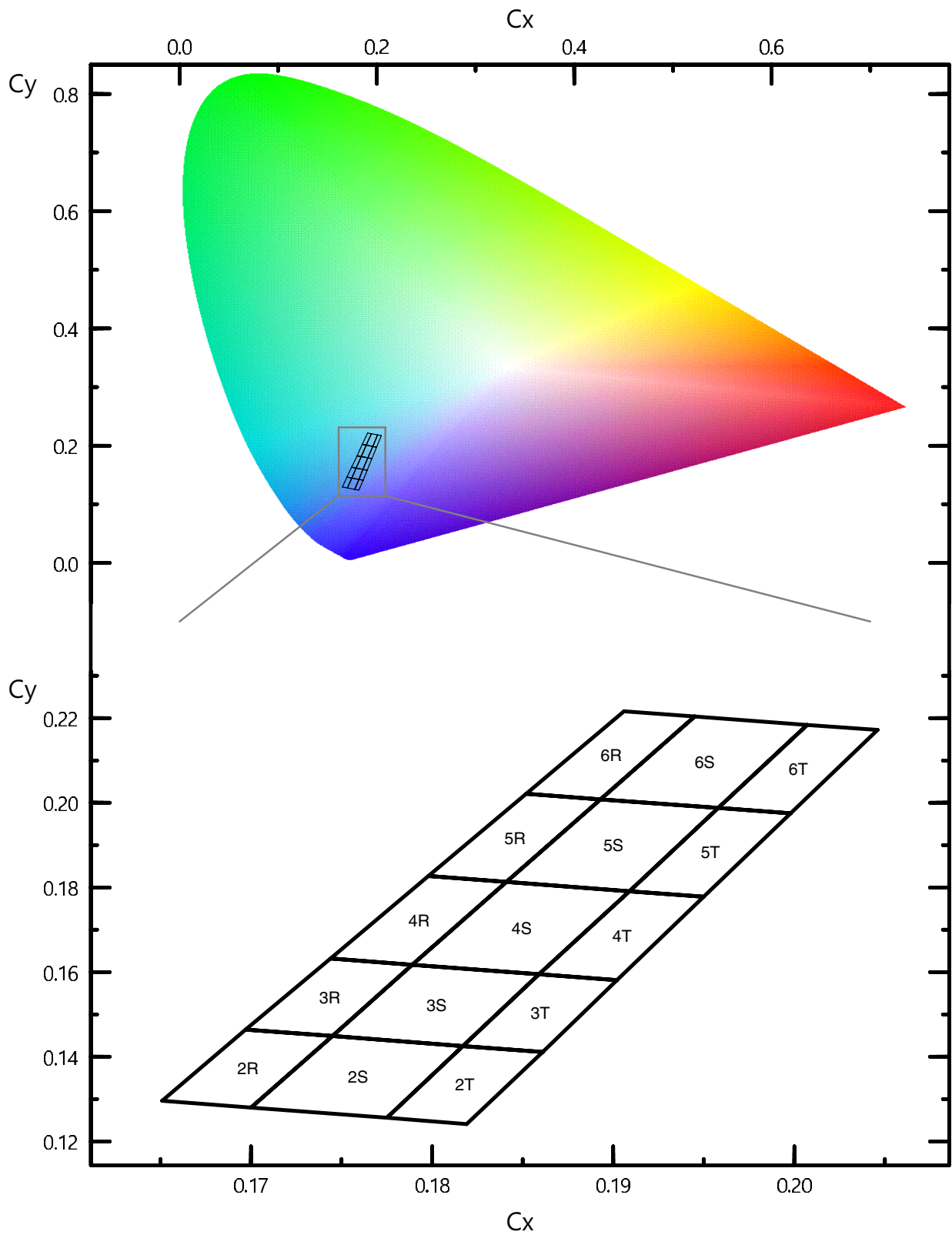

### Chromaticity Coordinate Groups <sup>3)</sup>

Group	Cx	Cy	Group	Cx	Cy	Group	Cx	Cy
2R	0.1697	0.1464	3T	0.1859	0.1595	5S	0.1893	0.2008
	0.1745	0.1449		0.1902	0.1581		0.1958	0.1988
	0.1700	0.1280		0.1861	0.1411		0.1909	0.1791
	0.1651	0.1296		0.1817	0.1425		0.1841	0.1813
2S	0.1745	0.1449	4R	0.1798	0.1827	5T	0.1958	0.1988
	0.1817	0.1425		0.1841	0.1813		0.1998	0.1975
	0.1775	0.1256		0.1789	0.1617		0.1950	0.1778
	0.1700	0.1280		0.1744	0.1632		0.1909	0.1791
2T	0.1817	0.1425	4S	0.1841	0.1813	6R	0.1906	0.2216
	0.1861	0.1411		0.1909	0.1791		0.1945	0.2204
	0.1819	0.1241		0.1859	0.1595		0.1893	0.2008
	0.1775	0.1256		0.1789	0.1617		0.1852	0.2021
3R	0.1744	0.1632	4T	0.1909	0.1791	6S	0.1945	0.2204
	0.1789	0.1617		0.1950	0.1778		0.2007	0.2184
	0.1745	0.1449		0.1902	0.1581		0.1958	0.1988
	0.1697	0.1464		0.1859	0.1595		0.1893	0.2008
3S	0.1789	0.1617	5R	0.1852	0.2021	6T	0.2007	0.2184
	0.1859	0.1595		0.1893	0.2008		0.2046	0.2172
	0.1817	0.1425		0.1841	0.1813		0.1998	0.1975
	0.1745	0.1449		0.1798	0.1827		0.1958	0.1988



---

## Group Name on Label

**Example: RH-2R-15**

Brightness	Color Chromaticity	Forward Voltage
RH	2R	15

---

### Relative Spectral Emission <sup>7)</sup>

$I_{rel} = f(\lambda)$ ;  $I_F = 5 \text{ mA}$ ;  $T_S = 25 \text{ }^\circ\text{C}$

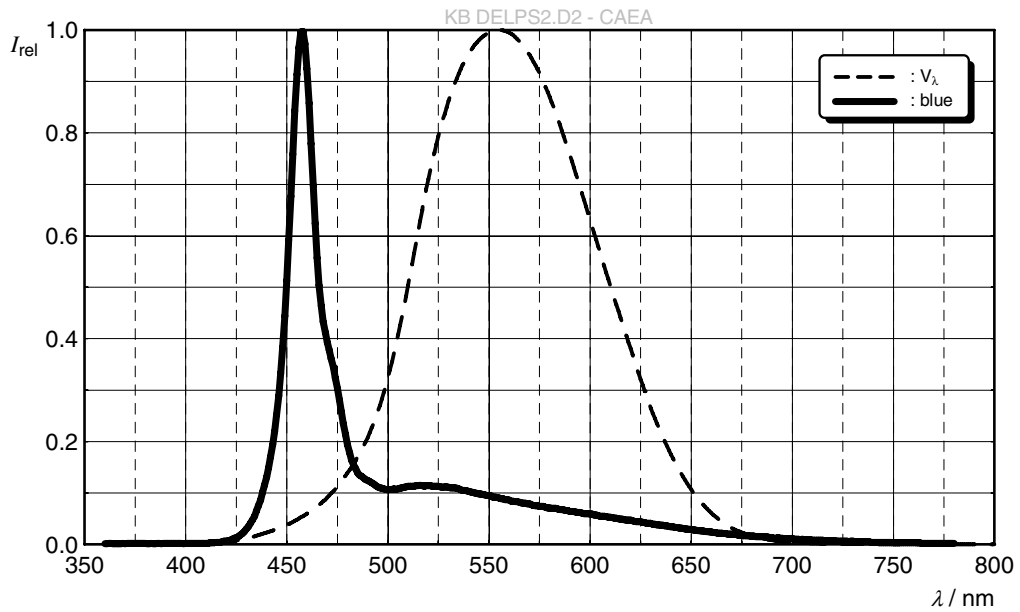

### Radiation Characteristics <sup>7)</sup>

$I_{rel} = f(\phi)$ ;  $T_S = 25 \text{ }^\circ\text{C}$

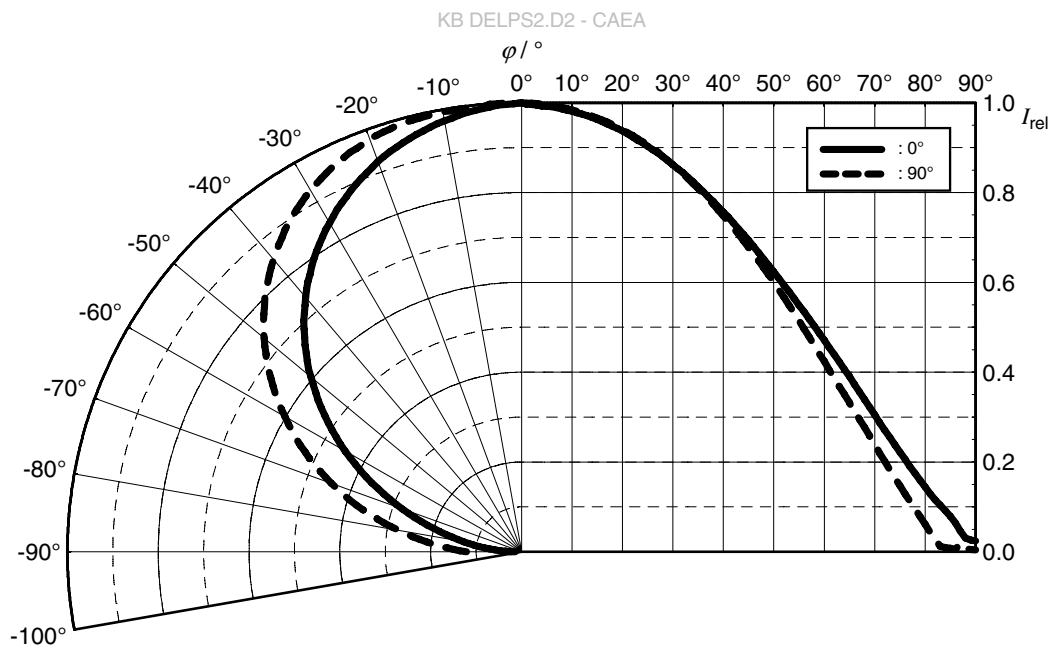

### Forward current <sup>7)</sup>

$$I_F = f(V_F); T_S = 25\text{ °C}$$

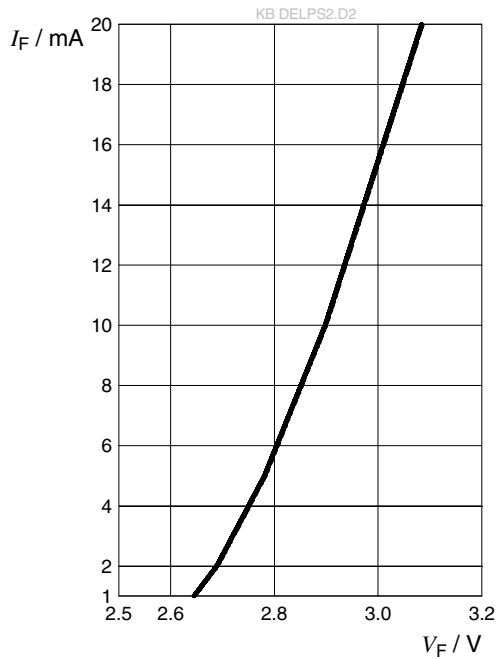

### Relative Luminous Intensity <sup>7)</sup>

$$I_V / I_V(5\text{ mA}) = f(I_F); T_S = 25\text{ °C}$$

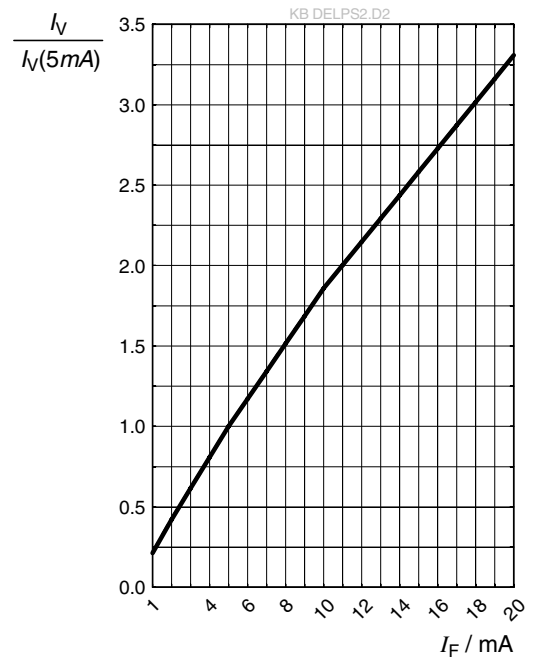

### Chromaticity Coordinate Shift <sup>7)</sup>

$$\Delta C_x, \Delta C_y = f(I_F); T_S = 25\text{ °C}$$

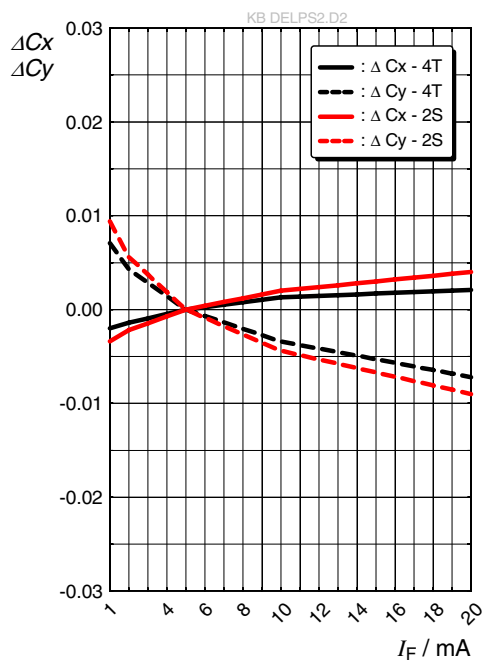

### Forward Voltage <sup>7)</sup>

$$\Delta V_F = V_F - V_F(25\text{ }^\circ\text{C}) = f(T_j); I_F = 5\text{ mA}$$

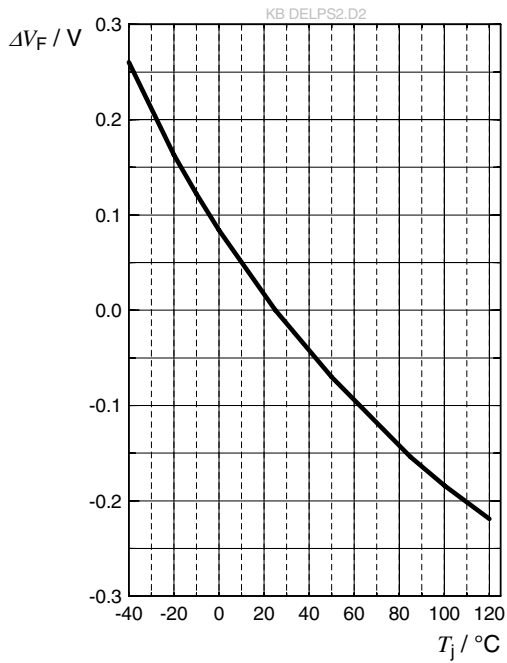

### Relative Luminous Intensity <sup>7)</sup>

$$I_V / I_V(25\text{ }^\circ\text{C}) = f(T_j); I_F = 5\text{ mA}$$

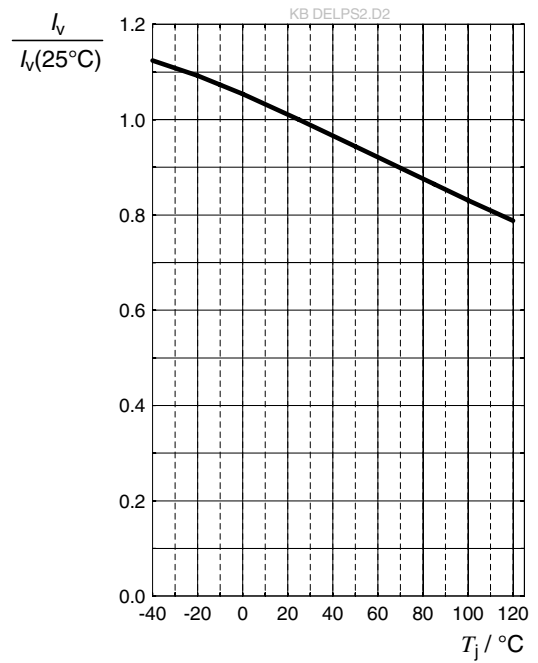

### Chromaticity Coordinate Shift <sup>7)</sup>

$$\Delta Cx, \Delta Cy = f(T_j); I_F = 5\text{ mA}$$

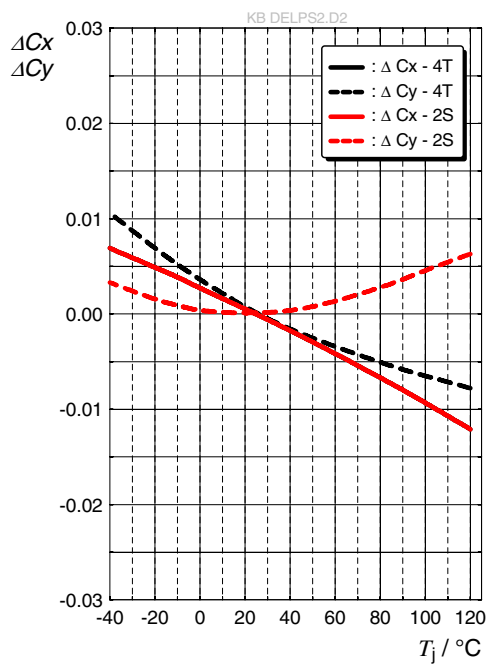

## Max. Permissible Forward Current

$I_F = f(T)$

KB DELPS2.D2

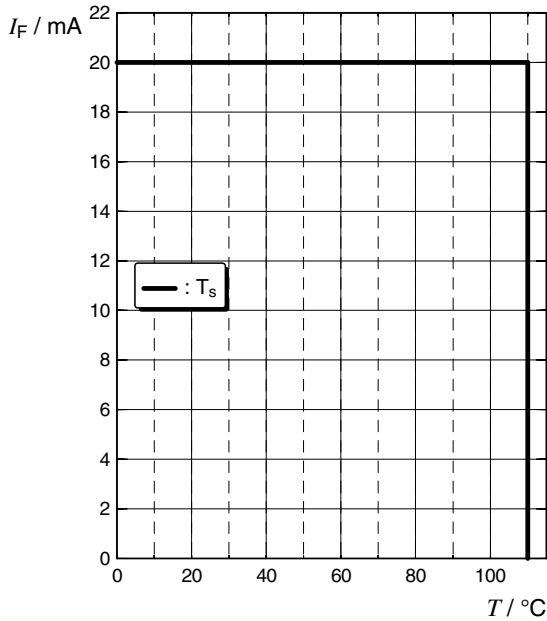

## Permissible Pulse Handling Capability

$I_F = f(t_p)$ ; D: Duty cycle

KB DELSS2.D1

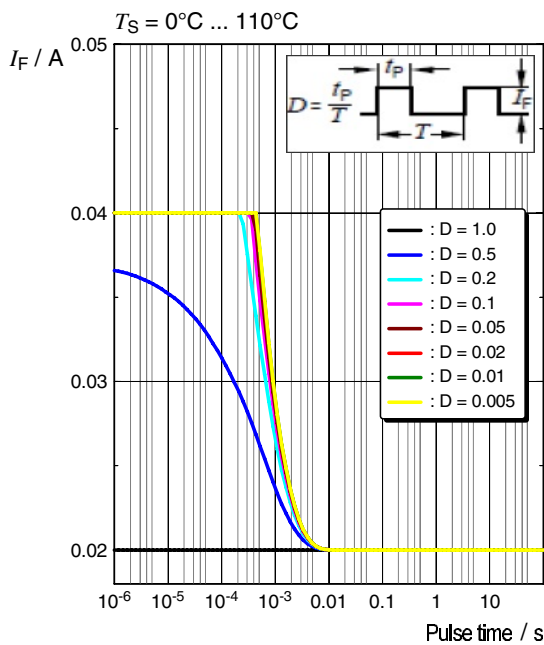

## Dimensional Drawing <sup>8)</sup>

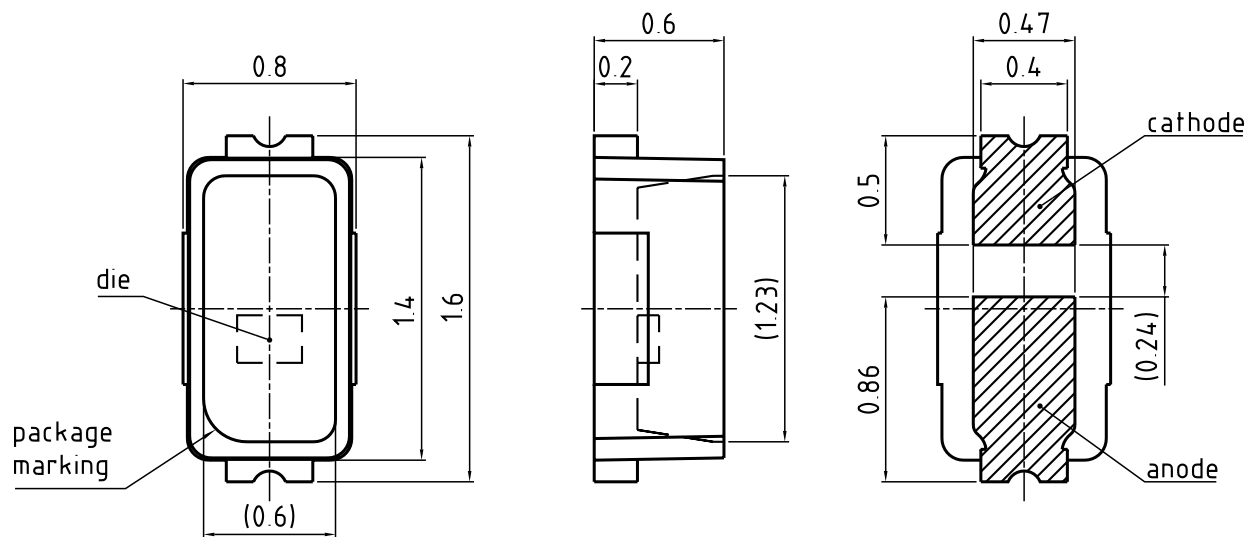

general tolerance  $\pm 0.1$   
lead finish Ag 

C63062-A4275-A1.-02

## Further Information:

**Approximate Weight:** 2.0 mg

**Package marking:** Anode

**Corrosion test:** Class: 2B

Test condition: 25°C / 75 % RH / 10 ppm H<sub>2</sub>S / 21 days (IEC 60068-2-43)

Electrical Internal Circuit

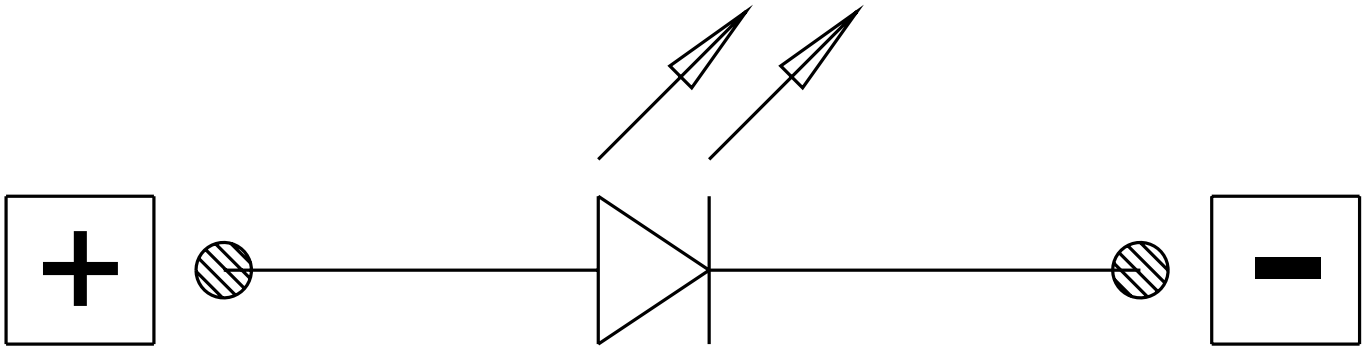

Recommended Solder Pad <sup>8)</sup>

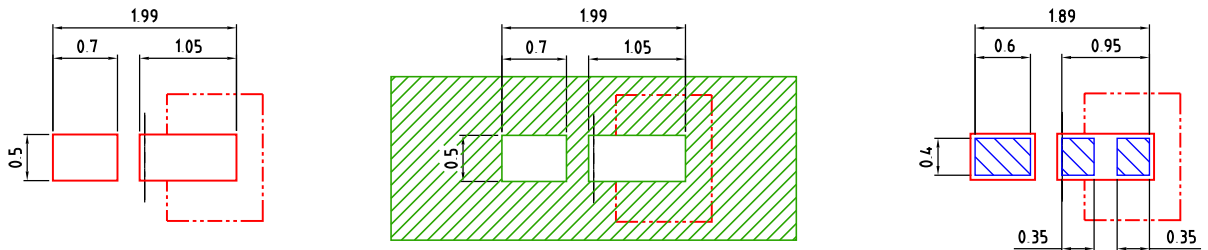

- foot print
- Cu area
- solder resist
- solder stencil

The usage of solder resist between anode and cathode pads is mandatory for applications where water may condense

Component Location on Pad

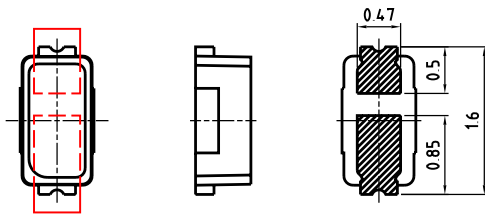

E062.3010.187 -02

All products are packed in a dry pack bag (Moisture Barrier Bag, MBB) according MIL-PRF-81705, after opening the MBB the products should go to reflow soldering process. Unused remaining LEDs should be protected from environment due to silver plated soldering terminal. In order to maintain solderability it is recommended to protect the silver plated solder terminals from corrosive environment before soldering. For superior solder joint connectivity results we recommend soldering under standard nitrogen atmosphere.

## Reflow Soldering Profile

Product complies to MSL Level 2 acc. to JEDEC J-STD-020E

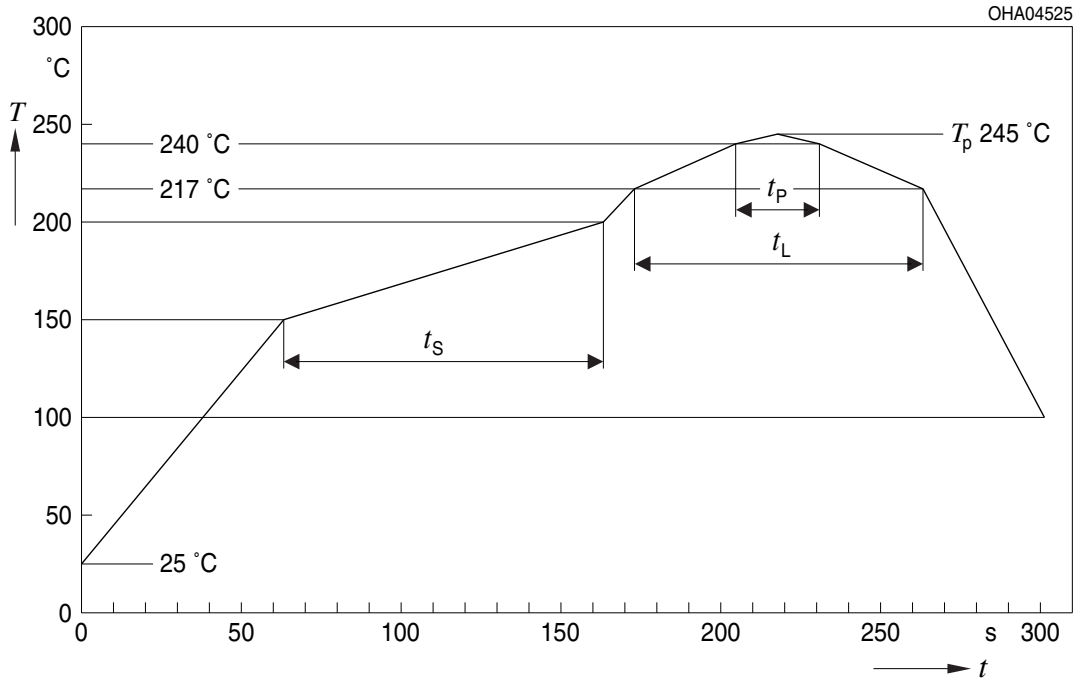

Profile Feature	Symbol	Pb-Free (SnAgCu) Assembly			Unit
		Minimum	Recommendation	Maximum	
Ramp-up rate to preheat <sup>*)</sup> 25 °C to 150 °C			2	3	K/s
Time $t_s$ $T_{Smin}$ to $T_{Smax}$	$t_s$	60	100	120	s
Ramp-up rate to peak <sup>*)</sup> $T_{Smax}$ to $T_p$			2	3	K/s
Liquidus temperature	$T_L$		217		°C
Time above liquidus temperature	$t_L$		80	100	s
Peak temperature	$T_p$		245	260	°C
Time within 5 °C of the specified peak temperature $T_p - 5$ K	$t_p$	10	20	30	s
Ramp-down rate* $T_p$ to 100 °C			3	6	K/s
Time 25 °C to $T_p$				480	s

All temperatures refer to the center of the package, measured on the top of the component

\* slope calculation  $DT/Dt$ :  $Dt$  max. 5 s; fulfillment for the whole T-range



Taping <sup>8)</sup>

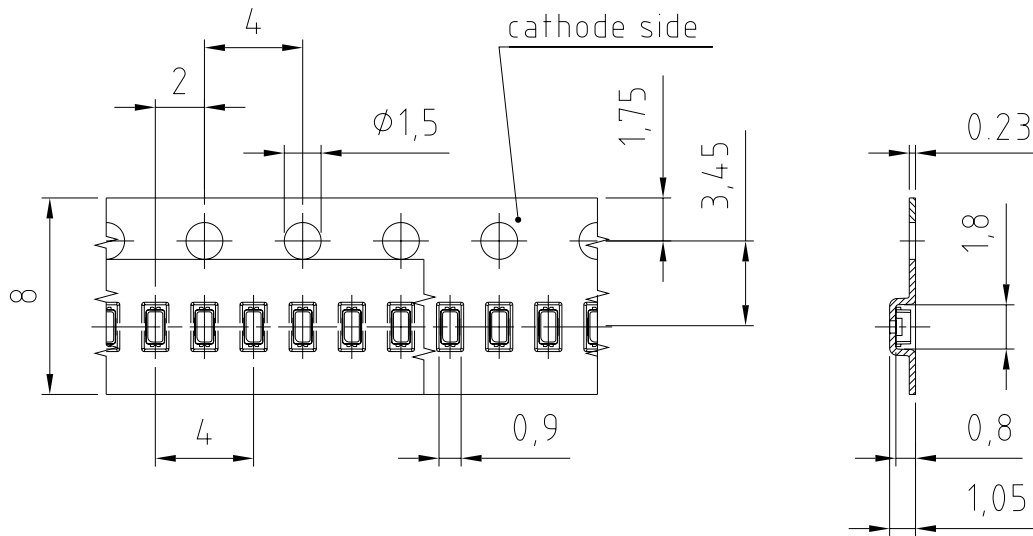

C63062-A4275-B5 -02

**Tape and Reel** <sup>9)</sup>

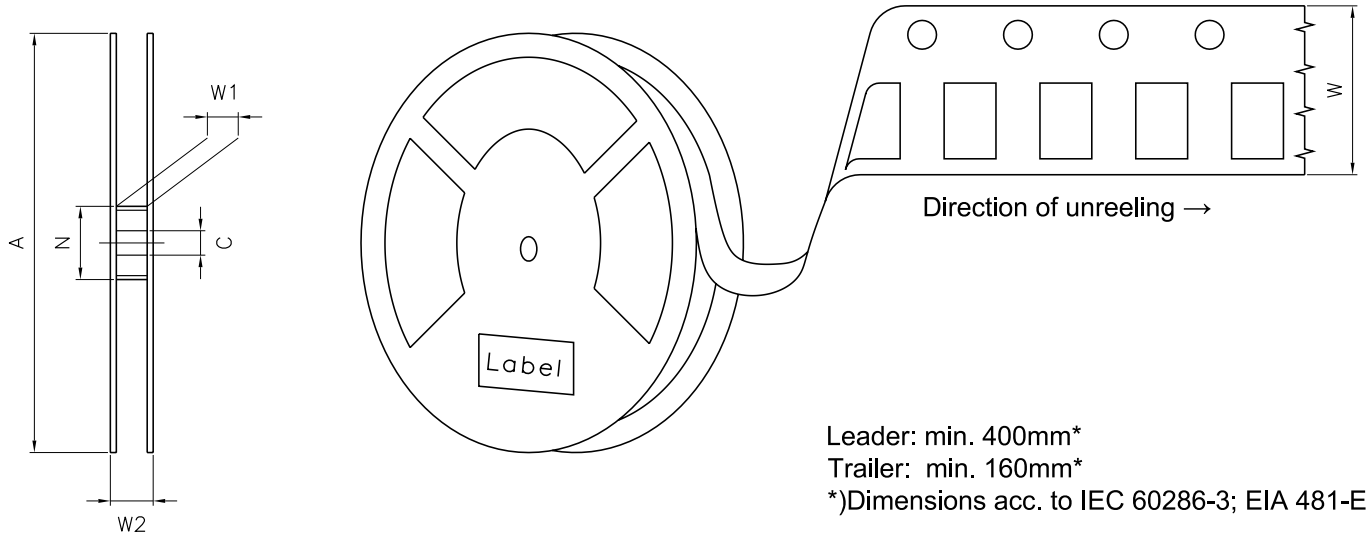

**Reel Dimensions**

A	W	N <sub>min</sub>	W <sub>1</sub>	W <sub>2 max</sub>	Pieces per PU
180 mm	8 + 0.3 / - 0.1 mm	60 mm	8.4 + 2 mm	14.4 mm	5000

### Barcode-Product-Label (BPL)

**OSRAM Opto Semiconductors** LX XXXX BIN1: XX-XX-X-XXX-X

RoHS Compliant

(6P) BATCH NO: 1234567890

(1T) LOT NO: 1234567890 (9D) D/C: 1234

(X) PROD NO: 123456789(Q)QTY: 9999 (G) GROUP: XX-XX-X-X

ML Temp ST  
X XXX °C X

Pack: RXX  
DEMY XXX  
X\_X123\_1234.1234 X

OHA04563

### Dry Packing Process and Materials <sup>8)</sup>

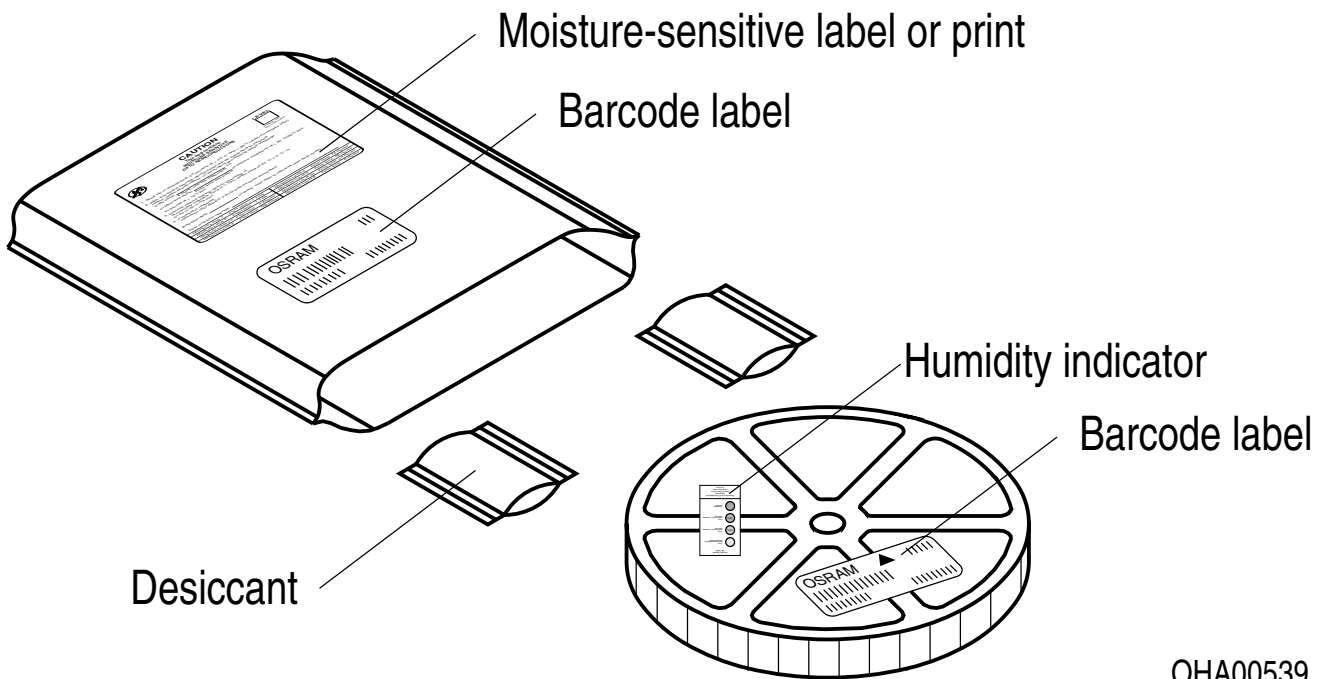

OHA00539

Moisture-sensitive product is packed in a dry bag containing desiccant and a humidity card according JEDEC-STD-033.

### Type Designation System

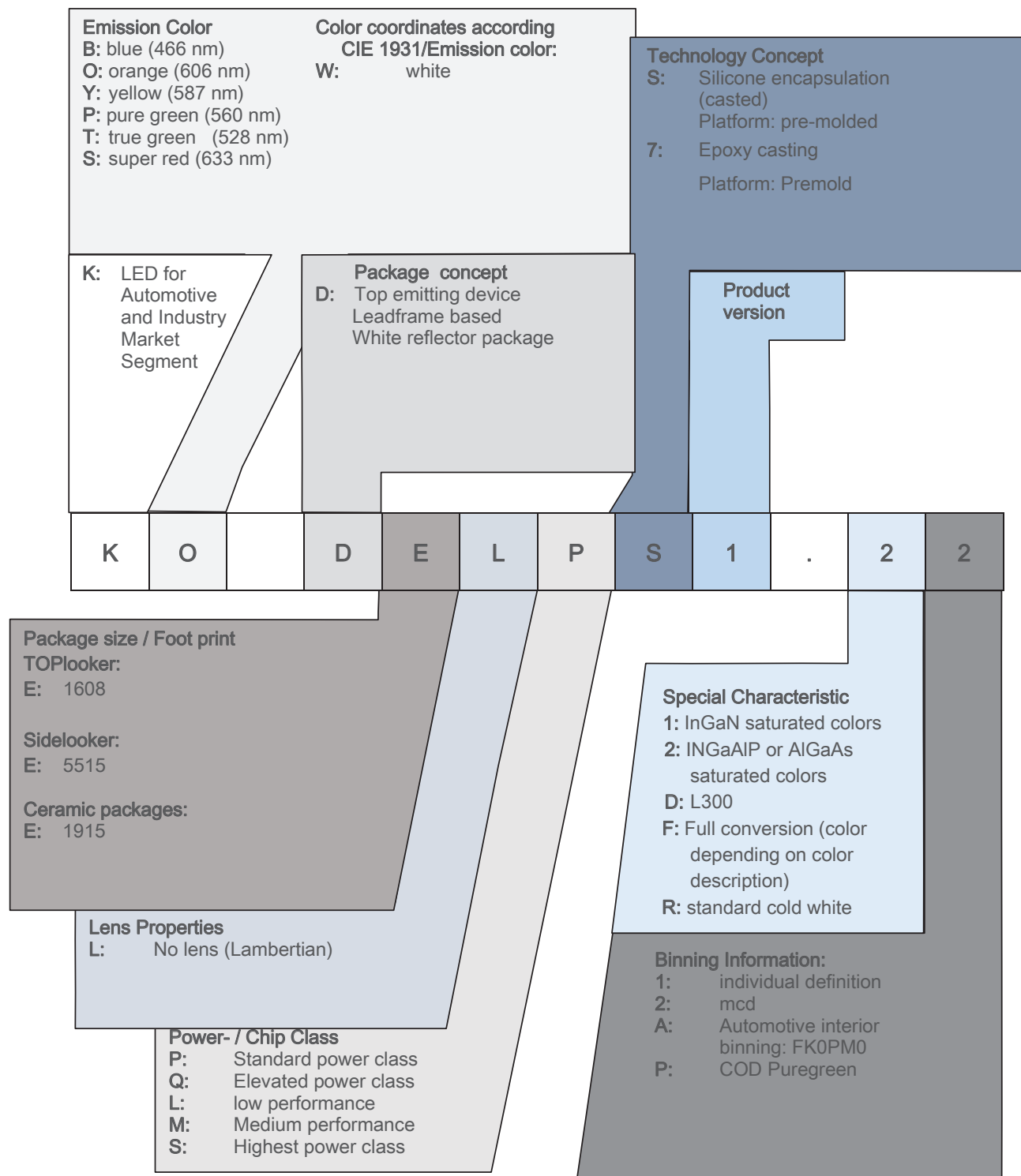

---

## Notes

The evaluation of eye safety occurs according to the standard IEC 62471:2006 (photo biological safety of lamps and lamp systems). Within the risk grouping system of this IEC standard, the device specified in this data sheet fall into the class **exempt group (exposure time 10000 s)**. Under real circumstances (for exposure time, conditions of the eye pupils, observation distance), it is assumed that no endangerment to the eye exists from these devices. As a matter of principle, however, it should be mentioned that intense light sources have a high secondary exposure potential due to their blinding effect. When looking at bright light sources (e.g. headlights), temporary reduction in visual acuity and afterimages can occur, leading to irritation, annoyance, visual impairment, and even accidents, depending on the situation.

Subcomponents of this device contain, in addition to other substances, metal filled materials including silver. Metal filled materials can be affected by environments that contain traces of aggressive substances. Therefore, we recommend that customers minimize device exposure to aggressive substances during storage, production, and use. Devices that showed visible discoloration when tested using the described tests above did show no performance deviations within failure limits during the stated test duration. Respective failure limits are described in the IEC60810.

For further application related information please visit [www.osram-os.com/appnotes](http://www.osram-os.com/appnotes)

## Disclaimer

### Attention please!

The information describes the type of component and shall not be considered as assured characteristics. Terms of delivery and rights to change design reserved. Due to technical requirements components may contain dangerous substances.

For information on the types in question please contact our Sales Organization.

If printed or downloaded, please find the latest version on our website.

### Packing

Please use the recycling operators known to you. We can also help you – get in touch with your nearest sales office. By agreement we will take packing material back, if it is sorted. You must bear the costs of transport. For packing material that is returned to us unsorted or which we are not obliged to accept, we shall have to invoice you for any costs incurred.

### Product and functional safety devices/applications or medical devices/applications

Our components are not developed, constructed or tested for the application as safety relevant component or for the application in medical devices.

Our products are not qualified at module and system level for such application.

In case buyer – or customer supplied by buyer – considers using our components in product safety devices/ applications or medical devices/applications, buyer and/or customer has to inform our local sales partner immediately and we and buyer and /or customer will analyze and coordinate the customer-specific request between us and buyer and/or customer.

---

## Glossary

- 1) **Brightness:** Brightness values are measured during a current pulse of typically 25 ms, with an internal reproducibility of  $\pm 8\%$  and an expanded uncertainty of  $\pm 11\%$  (acc. to GUM with a coverage factor of  $k = 3$ ).
- 2) **Reverse Operation:** This product is intended to be operated applying a forward current within the specified range. Applying any continuous reverse bias or forward bias below the voltage range of light emission shall be avoided because it may cause migration which can change the electro-optical characteristics or damage the LED.
- 3) **Chromaticity coordinate groups:** Chromaticity coordinates are measured during a current pulse of typically 25 ms, with an internal reproducibility of  $\pm 0.005$  and an expanded uncertainty of  $\pm 0.01$  (acc. to GUM with a coverage factor of  $k = 3$ ).
- 4) **Forward Voltage:** The forward voltage is measured during a current pulse of typically 8 ms, with an internal reproducibility of  $\pm 0.05$  V and an expanded uncertainty of  $\pm 0.1$  V (acc. to GUM with a coverage factor of  $k = 3$ ).
- 5) **Thermal Resistance:**  $R_{th\ max}$  is based on statistic values ( $6\sigma$ ).
- 6) **Thermal Resistance:**  $R_{thJA}$  results from mounting on PC board FR 4 (pad size 16 mm<sup>2</sup> per pad)
- 7) **Typical Values:** Due to the special conditions of the manufacturing processes of semiconductor devices, the typical data or calculated correlations of technical parameters can only reflect statistical figures. These do not necessarily correspond to the actual parameters of each single product, which could differ from the typical data and calculated correlations or the typical characteristic line. If requested, e.g. because of technical improvements, these typ. data will be changed without any further notice.
- 8) **Tolerance of Measure:** Unless otherwise noted in drawing, tolerances are specified with  $\pm 0.1$  and dimensions are specified in mm.
- 9) **Tape and Reel:** All dimensions and tolerances are specified acc. IEC 60286-3 and specified in mm.

---

## Revision History

Version	Date	Change
1.0	2019-10-16	Initial Version
1.0	2022-08-16	Initial Version
1.1	2022-11-16	Tape and Reel Reel Dimensions

---





EU RoHS and China RoHS compliant product

此产品符合欧盟 RoHS 指令的要求；  
按照中国的相关法规和标准，  
不含有毒有害物质或元素。

**Published by ams-OSRAM AG**

Tobelbader Strasse 30, 8141 Premstaetten, Austria

Phone +43 3136 500-0

[ams-osram.com](http://ams-osram.com)

© All rights reserved

**am** 

**OSRAM**