

**General information**

<b>Part number</b>	K21MA7-P07LFDO-657S
<b>Termination</b>	solder
<b>Size</b>	1
<b>Locking principle</b>	break , push
<b>Coding</b>	a_key_medi
<b>Cable Diameter</b>	cable_medi_65
<b>Cable outlet</b>	bend_relief

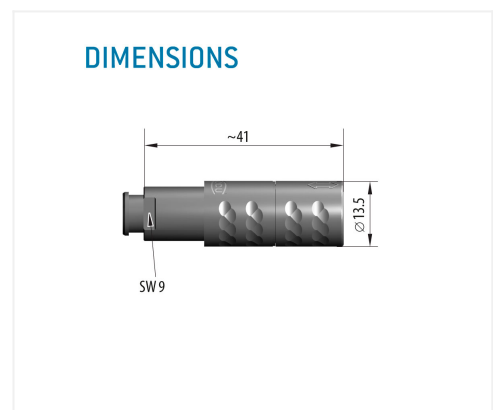
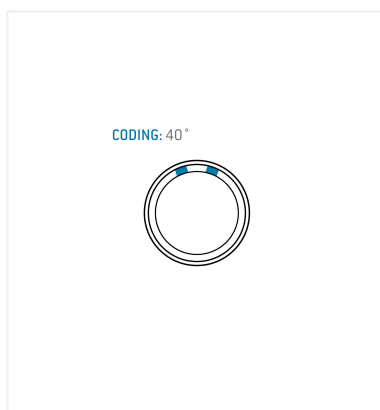

**Contact insert description**

<b>Number of contacts</b>	7
<b>Contact type</b>	sockets
<b>Contact diameter</b>	07mm
<b>Insulator material</b>	peek
<b>Wire cross section</b>	26_awg
<b>Termination</b>	solder
<b>Termination diameter</b>	065mm

reverse\_gender\_on\_request

**Technical information**

<b>Max. creepage and air clearance distance</b>	085_mm	iec_60601_1mopp_2moop
<b>Nominal current single contact</b>	06_a	iec_60512_5_2
<b>Nominal current insert</b>	3,9 A	vde_0298_4
<b>Test voltage</b>	16_kv_dc	sae_13441

safety\_text

## Mechanical and environmental data

Degree of protection*	ip50
Operating temperature	50_120_c
Mating cycles	5000

mated\_unmated

## Insulator materials MEDI-SNAP®

psu\_peek

## Material and surface treatments

Housing	psu_gray
Color option	gray
Contact	cu_alloy_gold

safety\_text\_2  
ul\_text  
illustrative\_text