

General information

Part number	K11MA7-P10LCC0-3920
Termination	solder
Size	1
Locking principle	break , push
Coding	a_key_medi
Cable Diameter	cable_medi_39
Cable outlet	standard

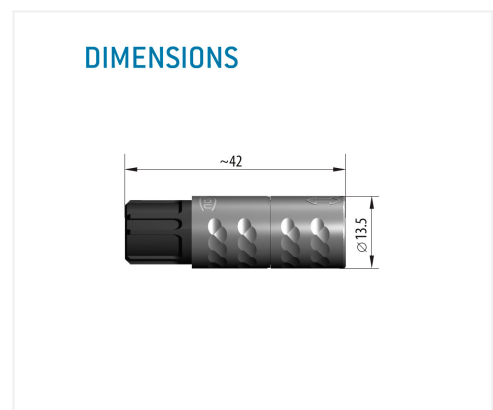
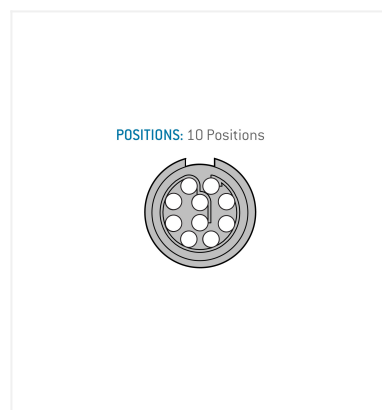
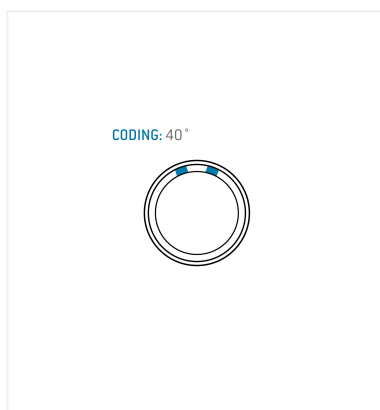

Contact insert description

Number of contacts	10
Contact type	sockets
Contact diameter	05mm
Insulator material	peek
Wire cross section	28_awg
Termination	solder
Termination diameter	045mm

reverse_gender_on_request

Technical information

Max. creepage and air clearance distance	05_mm	iec_60601_1mopp_2moop
Nominal current single contact	04_a	iec_60512_5_2
Nominal current insert	2,2 A	vde_0298_4
Test voltage	135_kv_dc	sae_13441

safety_text

Mechanical and environmental data

Degree of protection*	ip50
Operating temperature	50_120_c
Mating cycles	5000

mated_unmated

Insulator materials MEDI-SNAP®

psu_peek

Material and surface treatments

Housing	psu_gray
Color option	red
Contact	cu_alloy_gold

safety_text_2
ul_text
illustrative_text