



# Intel® Agilex™ F-Series FPGA (Two F-Tiles) Development Kit User Guide



[Online Version](#)



[Send Feedback](#)

ID: **739942**

Version: **2022.09.21**

# Contents

---

- 1. Overview..... 4**
  - 1.1. Block Diagram.....4
  - 1.2. Feature Summary.....5
  - 1.3. Box Contents..... 6
  - 1.4. Recommended Operating Conditions..... 6
- 2. Getting Started..... 7**
  - 2.1. Intel Quartus® Prime Software and Driver Installation..... 7
  - 2.2. Design Examples..... 7
- 3. Power Up the Development Kit..... 9**
  - 3.1. Default Settings..... 9
  - 3.2. Applying Power to the Development Board..... 10
- 4. Board Test System..... 12**
  - 4.1. Set Up BTS GUI Running Environment..... 12
    - 4.1.1. Download OpenJDK..... 13
    - 4.1.2. Download OpenJFX..... 13
    - 4.1.3. Install OpenJDK and OpenJFX..... 13
    - 4.1.4. Install the Intel Quartus Prime Software ..... 14
    - 4.1.5. Run BTS GUI..... 14
  - 4.2. Test the Functionality of the Development Kit..... 16
    - 4.2.1. The Bottom Info Bar..... 16
    - 4.2.2. The Configure Menu..... 16
    - 4.2.3. The Sys Info Tab..... 17
    - 4.2.4. The GPIO Tab..... 18
    - 4.2.5. The XCVR Tab..... 19
    - 4.2.6. The Memory Tab..... 23
  - 4.3. Control On-Board Clock through Clock Controller GUI..... 25
  - 4.4. Monitor On-Board Power Regulator through Power Monitor GUI..... 26
  - 4.5. BTS Test Areas..... 27
  - 4.6. Identify Test Pass- or Fail-based on BTS GUI Test Status..... 27
- 5. Development Kits Hardware and Configuration.....28**
  - 5.1. JTAG Configuration Mode..... 28
  - 5.2. Active Serial (AS) x4 Configuration Mode..... 28
  - 5.3. Avalon-ST x16 Configuration Mode..... 28
- 6. Custom Projects for the Development Kit..... 30**
  - 6.1. Add SmartVID Settings in the Intel Quartus Prime QSF File..... 30
  - 6.2. Golden Top..... 30
- 7. Revision History..... 31**
- A. Development Kit Components..... 32**
  - A.1. Board Overview and Components..... 32
    - A.1.1. Board Overview..... 32
    - A.1.2. Board Components..... 32
    - A.1.3. Intel MAX 10 CPLD System Controller..... 36

A.2. FPGA Configuration.....	36
A.2.1. Programming the FPGA over On-Board Intel FPGA Download Cable II.....	37
A.2.2. Programming the FPGA over an External Intel FPGA Download Cable II.....	37
A.3. Default Switch and Jumper Settings.....	37
A.3.1. Switch Description.....	38
A.3.2. Jumper Description.....	39
A.4. Input and Output Components.....	40
A.4.1. Push Buttons.....	40
A.4.2. Switches.....	40
A.4.3. LEDs.....	41
A.5. Components and Interfaces.....	41
A.5.1. PCI Express (PCIe) Interface.....	41
A.5.2. QSFP-DD Interface.....	44
A.5.3. QSFP Interface.....	46
A.5.4. CXL Interface.....	47
A.5.5. DDR4 DIMM1 Interface.....	48
A.5.6. DDR4 DIMM2 Interface.....	52
A.5.7. DDR4 Component Interface.....	57
A.5.8. HPS I/O48 Interface.....	60
A.6. I <sup>2</sup> C.....	61
A.7. Intel MAX 10 SPI Bus.....	63
A.8. Clock Circuits.....	63
A.9. HPS Daughter Card.....	64
A.10. System Power.....	66
A.11. Power Guidelines.....	67
A.11.1. In a Standard PCIe-Compliant System.....	67
A.11.2. As a Standalone Evaluation Board Powered by Included Power Supply.....	67
A.12. Power Distribution System.....	68
A.13. Power Measurement.....	69
A.14. Thermal Limitations and Protection.....	69
<b>B. Additional Information.....</b>	<b>70</b>
B.1. Safety and Regulatory Information.....	70
B.1.1. Safety Warnings.....	71
B.1.2. Safety Cautions.....	72
B.2. Compliance Information.....	75

## 1. Overview

The Intel® Agilex™ FPGA Development Kit provides a hardware development platform for evaluating the performance and features of the Intel Agilex F-Series FPGA with two F-tiles.

**Table 1. Ordering Information**

Development Kit Version	Ordering Code	Device Part Number
Intel Agilex F-Series FPGA (Two F-Tiles Edition) Development Kit (ES)	DK-DEV-AGF027F1ES	AGFB027R24C2E2VR2 <sup>(1)</sup>

For more information about the *Intel Agilex ES Device Errata Sheet and User Guidelines (ES-1069)*, contact Intel Premier Support and quote ID #15011992053.

### 1.1. Block Diagram

**Figure 1. Intel Agilex F-Series FPGA (Two F-Tiles) Development Kit Block Diagram**

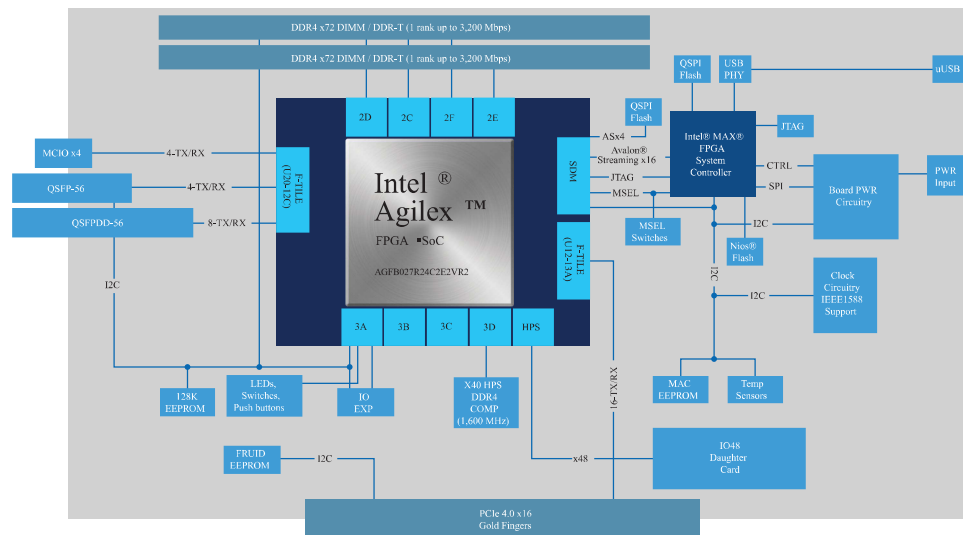

<sup>(1)</sup> AGFB027R24C2E2VR2 supports PCIe\* x8 interface and not PCIe x16 interface.

## 1.2. Feature Summary

- Intel Agilex F-Series (AGFB027) device in 2340A BGA package
  - Quad-core 64-bit Arm Cortex-A53 hard processor (HPS)
  - 0.8 V VID-adjustable VCC core
  - Dual F-tile transceivers supporting 56 Gbps (PAM4) and 32 Gbps (NRZ) data rates
  - 2.69M logic elements (LE)
  - 3.65M adaptive logic modules (ALM)
  - 8.5K digital signal processing (DSP) blocks
- FPGA configuration
  - Avalon<sup>®</sup>-ST x16 and active serial (AS) x4 configuration modes support
  - 2 Gb flash for AS x4
  - Dual 2 Gb flash for Avalon-ST x16
  - JTAG header for device programming
  - Built-in Intel FPGA Download Cable II for device programming
- Programmable clock sources
- Transceiver interfaces
  - PCI Express\* (PCIe) x16 interface supporting Gen 4 end-point connected to a PCIe x16 edge connector (gold edge fingers)
  - 1x QSFP optical module interface connected to F-tile transceiver
  - 1x QSFPDD optical module interface connected to F-tile transceiver
  - 1x PCIe/CXL interface supporting x4 interface connected to MCIO connector
- Memory interfaces
  - Two x72 DIMM sockets supporting DDR4-2666 or DDR-T Intel Optane<sup>™</sup> persistent memory module
  - Single x40 DDR4 component interface for HPS processor memory
- Communication ports
  - JTAG header
  - Micro USB on-board Intel FPGA Download Cable II
  - System I2C header
- Buttons, switches, and LEDs
  - CPU reset push button
  - PCIe reset push button
  - CXL reset push button
  - HPS reset push button
  - Four dedicated user LEDs
  - Board power good LED
  - FPGA configuration done LED

- Heatsink and fan
  - Air-cooled heatsink assembly
  - Red over-temperature warning LED
- Power
  - PCIe input power including required 2x4 auxiliary power connector
  - Blue power-good status LED
  - On/off slide power switch for benchtop operation
  - On-board power and temperature measurement circuitry
- Mechanical
  - PCIe standard height form-factor (full height, ¾ length, dual-width)
  - 4.375" x 10.0" board size
  - Two slots height with heatsink/fan assembly
- Operating environment
  - Maximum ambient temperature of 0-35°C

### 1.3. Box Contents

- Intel Agilex F-Series (Two F-Tiles)FPGA Development Kit
- 1x DDR4 DIMM module
- 1x IO48 HPS daughter board
- USB 2.0 MicroUSB cable
- 240W power adapter and NA/EU/JP/UK cords

### 1.4. Recommended Operating Conditions

**Table 2. Recommended Operating Conditions**

Operating Condition	Range of Values
Ambient operating temperature range	0°C to 35°C
Maximum ICC load current	150 A
Maximum ICC load transient percentage	30%
FPGA maximum power supported by active heatsink/fan	150 W

When handling the board, it is important to observe static discharge precautions.

**Caution:** Without proper anti-static handling, the board can be damaged. Therefore, use anti-static handling precautions when touching the development kit.

**Caution:** This development kit should not be operated in a vibration environment.

## 2. Getting Started

---

### 2.1. Intel Quartus® Prime Software and Driver Installation

Intel Quartus® Prime design software is a multiplatform design environment that easily adapts to your specific needs in all phases of FPGA, CPLD and SoC designs. The Intel Quartus Prime software delivers the highest performance and productivity for Intel FPGAs, CPLDs, and SoCs. Intel Quartus Prime Pro Edition software is optimized to support the advanced features in next-generation FPGAs and SoCs with the Intel Agilex, Intel Stratix® 10, Intel Arria® 10, and Intel Cyclone® 10 GX device families.

Intel Agilex F-Series (Two F-Tiles) Development Kit includes on-board Intel FPGA Download Cable II circuits for FPGA and system Intel MAX® 10 programming. However, for the host computer and board to communicate, you must install the Intel FPGA Download Cable II driver on the host computer. Installation instructions for the Intel FPGA Download Cable II driver for your operating system are available on the Intel website.

On the Intel website, navigate to the [Cable and Adapter Drivers Information](#) link to locate the table entry for your configuration and click the link to access the instructions.

#### Related Information

- [Quick-Start for Intel Quartus Prime Pro Edition Software](#)
- [Intel Quartus Prime Pro Edition User Guide: Getting Started](#)

### 2.2. Design Examples

Unzip the install package which includes board design files, documents and examples directories. The table below lists the file directory names and a description of their contents.

**Table 3. Installed Development Kit Directory Structure**

Directory Name	Description of Directory Contents
board_design_files	Contains schematics, layout, assembly and bill of material board design files. Use these files as a starting point for a new prototype board design.
demos	Contains demonstration applications when available.
documents	Contains the development kit documentation.
examples	Contains:

*continued...*

Directory Name	Description of Directory Contents
	<ul style="list-style-type: none"> <li>• Board Test System: BTS GUI, Power GUI, and Clock GUI</li> <li>• Golden Top project for pinout assignments management</li> <li>• Design Examples: Memory, XCVR, GPIO, PCIe Gen 4</li> </ul>
factory_recovery	Contains the original data programmed onto the board before shipment. Use this data to restore the board with its original factory content.



## 3. Power Up the Development Kit

This chapter describes how to apply power to the development board and provides default switch and jumper settings.

### 3.1. Default Settings

The Intel Agilex F-Series FPGA (Two F-Tiles) Development Kit ships with its board switches preconfigured to support the design examples in the kit. If you suspect your board might not be correctly configured with the default settings, follow the instructions in the table below to return to its factory settings before proceeding.

**Table 4. Factory Default Switch Settings**

Switch	Default Position	Function			
SW1 [1:4]	ON/OFF/OFF/OFF	PCIe PRSNT x1/x4/x8/x16 settings switches. Default = x16.			
		<b>PRSNT x16</b>	<b>PRSNT x8</b>	<b>PRSNT x4</b>	<b>PRSNT x1</b>
		ON	OFF	OFF	OFF
SW2	ON	Intel FPGA Download Cable II JTAG Selection switch. Default ON selects the micro-USB port on-board blaster for FPGA programming.			
SW3 [1:4]	ON/ON/ON/OFF	Configuration mode selection, BMC JTAG selection, and HPS JTAG Bypass switches. SW3 [1:2] —Configuration mode selection. MSEL0 is pulled high. Default mode is AS x4.			
		<b>Mode</b>	<b>SW3 [1] - MSEL1</b>	<b>SW3 [2] - MSEL2</b>	
		JTAG	OFF	OFF	
		Avalon-ST x16	ON	OFF	
		AS x4 (Fast)	ON	ON	
		SW3 [3] —BMC JTAG selection. <ul style="list-style-type: none"> <li>ON selects the on-board blaster as JTAG master when no external blaster is plugged</li> <li>OFF selects the PCIe RP as JTAG master when no external blaster is plugged</li> <li>Default JTAG chain selects the FPGA</li> </ul> SW4 [4] —HPS JTAG Enable. <ul style="list-style-type: none"> <li>ON enables the HPS as part of the JTAG chain</li> <li>OFF bypasses the HPS from the JTAG chain</li> <li>The HPS is set to bypass by default</li> </ul>			
SW4 [1:4]	OFF/OFF/OFF/OFF	Clock features selection switches.			

*continued...*

Switch	Default Position	Function
		<p>SW4 [4]—SI52204 (U25) PCIe clock power down.</p> <ul style="list-style-type: none"> <li>ON powers down the PCIe clocks</li> <li>OFF powers on the PCIe clocks (Default)</li> </ul> <p>SW4 [3]—PCIe <i>refclk</i> source selection.</p> <ul style="list-style-type: none"> <li>ON selects the local 100 Mhz clock source for PCIe</li> <li>OFF selects 100 Mhz clock source from the PCIe edge fingers (Default)</li> </ul> <p>SW4 [2]—CXL <i>refclk</i> source selection.</p> <ul style="list-style-type: none"> <li>ON selects local 100 Mhz clock source for CXL <i>refclk</i></li> <li>OFF select 100 Mhz clock source from CXL connector (Default)</li> </ul> <p>SW4 [1]—PCIe clock spread spectrum enable.</p> <ul style="list-style-type: none"> <li>ON—Enable 0.5% down-spread</li> <li>OFF—Spread spectrum disable (Default)</li> </ul>
SW5	OFF	Power switch. Slide to ON position to turn on the board. Default is OFF.
SW6	OFF	<p>Intel MAX 10 JTAG_EN switch.</p> <ul style="list-style-type: none"> <li>ON sets the JTAG pins to function as dual-purpose I/O pins and JTAG function if the JTAG pin sharing option bit is enabled by the Intel Quartus Prime software.</li> <li>OFF sets the JTAG pins to function as JTAG dedicated pins if the JTAG pin sharing option bit is enabled by the Intel Quartus Prime software (Default).</li> </ul>

### 3.2. Applying Power to the Development Board

This development kit is designed to operate in two modes:

#### As a PCIe Add-In Card

When operating the card as a PCIe system, insert the card into an available PCIe slot and connect a 2x4 pin PCIe power cable from the system to power connectors at **J11** of the board.

*Note:* When operating as a PCIe add-in card, the board does not power on unless power is supplied to **J11**.

#### In Bench-Top Mode

In bench-top mode, you must supply the board with the provided power 240 W power supply connected to the power connector **J11**. The following describes the operation in bench-top mode.

This development board ships with its switches preconfigured to support the design examples in the kit.

If you suspect that your board may not be correctly configured with the default settings, follow the instructions in the *Default Switch and Jumper Settings* section.

1. The development board ships with design examples stored in the flash memory device for Avalon-ST x16. Ensure SW3 [1] is ON and SW3 [2] is OFF before powering up the board.
2. Connect the supplied power supply to an outlet and the DC Power Jack to **J11** on the FPGA board.

*Note:* Use only the supplied power supply. Power regulation circuits on the board can be damaged by power supplies with greater voltage.

3. Set the power switch (**SW5**) to the **ON** position.

When the board powers up, the blue power-on LED (**D2**) illuminates signaling the board is ready for use. Since the default configuration mode is Avalon-ST x4, the FPGA automatically downloads its configuration image from the QSPI flash device connected to the FPGA's SDM interface. When the configuration is complete, green LED (**D12**) illuminates signaling the device configured successfully. If the configuration fails, **D12** will not illuminate.

## 4. Board Test System

The Intel Agilex F-Series FPGA (Two F-Tiles) Development Kit includes design examples and the board test system (BTS) GUI to test the functionality of this board. The BTS provides an easy-to-use interface to alter functional settings and observe results. You can use the BTS to test board components, modify functional parameters, observe performance, and measure power usage.

While using the BTS, you reconfigure the FPGA several times with test designs specific to the functionality that you are testing. The BTS is also useful as a reference for designing systems. The BTS communicates over the JTAG bus to a test design running in the Intel Agilex F-Series FPGA device.

The following figure shows the graphical user interface (GUI) of a board that is in factory configuration.

**Figure 2. BTS GUI**

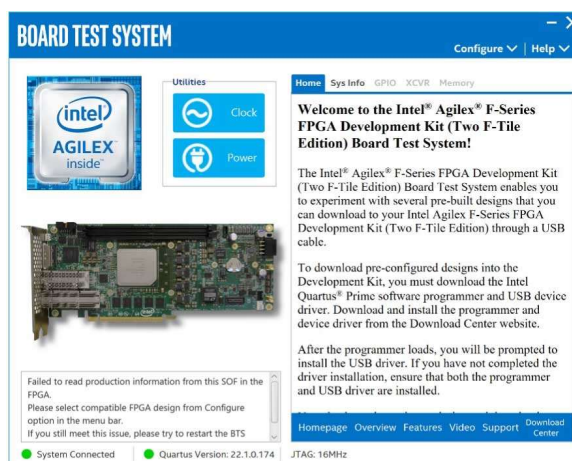

### 4.1. Set Up BTS GUI Running Environment

To run BTS GUI, including Power Monitor and Clock Controller GUI, you need to download and install Java runtime including OpenJDK and OpenJFX on your systems and set up the running environment. This is a one-time procedure, so if you have already completed it before, you do not need to do it again unless the Java version upgrade is needed.

### 4.1.1. Download OpenJDK

To download the Temurin OpenJDK, follow these steps:

1. Download the Temurin OpenJDK using this link: <https://adoptium.net/releases.html>.
2. Select Architecture x64, Package Type JRE, and Version 11.
3. On **Windows** system, choose the JRE zip format file.
4. On **Linux** system, choose the JRE tar.gz format file.

Figure 3. OpenJDK Version

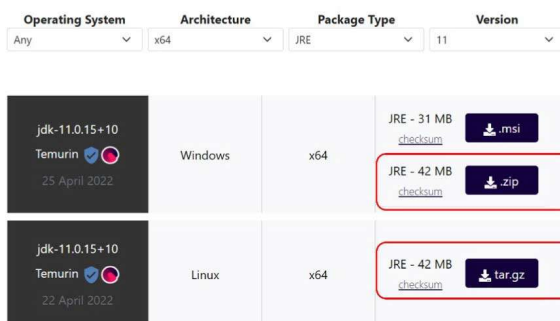

Note: The JDK version can be updated, download the latest version.

### 4.1.2. Download OpenJFX

To download the OpenJFX, follow these steps:

1. Download the OpenJFX using this link: <https://gluonhq.com/products/javafx/>.
2. Select JavaFX version 17.0.2.
3. For the **Windows** system, download the JavaFX Windows x64 SDK.
4. For **Linux** system, download the JavaFX Linux x64 SDK.

Figure 4. JavaFX Version

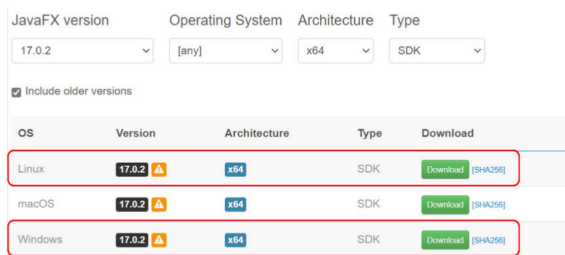

### 4.1.3. Install OpenJDK and OpenJFX

You have two downloaded zip files, follow these steps to install them.

1. On **Windows** system, Intel recommends you to unzip the files and put them in the following directory:
  - C:\Program Files\Java\jre

— C:\Program Files\Java\jfx

*Note:* The unzipped folder name of JRE is `jdk-11.0.xx+x-jre` (for example, `jdk-11.0.15+10-jre`), you need to rename it to `jre`. The unzipped folder name of JFX is `javafx-sdk-17.0.2`, you need to rename it to `jfx`.

2. On **Linux** system, Intel recommends you to unzip the files and rename the folders using the following commands:

```
# unzip openjfx-17.0.2_linux-x64_bin-sdk.zip -d /opt/Java/
# tar zxvf OpenJDK11U-jre_x64_linux_hotspot_11.0.15_10.tar.gz -C /opt/Java/
# cd /opt/Java
# mv javafx-sdk-17.0.2 jfx
# mv jdk-11.0.15+10-jre jre
```

You have the following two directories on your **Linux** system:

- /opt/Java/jre
- /opt/Java/jfx

#### 4.1.4. Install the Intel Quartus Prime Software

You need to install the Intel Quartus Prime software that can support the silicon on the development kit. The recommended version can be found in the `README.txt` file under `examples\board_test_system` directory. If you choose to install individual files, you must install the Intel Agilex device support.

The BTS communicates over JTAG to a test design running in the FPGA. The BTS and Power Monitor share the JTAG with other applications like the Nios® II Gen 2 JTAG Debug Module and the Signal Tap Logic Analyzer. Ensure closing other applications before you use the BTS, because the BTS is designed based on the Intel Quartus Prime software.

The BTS relies on the Intel Quartus Prime software's specific library. Before running the BTS, open the Intel Quartus Prime software to automatically set the environment variable `QUARTUS_ROOTDIR`. Otherwise, you can change it through the Environment Variables in System Properties on Windows. The BTS uses this environment variable to locate the Intel Quartus Prime library.

#### 4.1.5. Run BTS GUI

With the power to the board off, follow these steps:

1. Connect the USB cable to your PC and the board.
2. Ensure the development board switches and jumpers are set according to your preferences. For more information, refer to the *Factory Default Switch Settings* section.
3. Check the external modules' status: QSFP/QSFPDD/DDR4 DIMM.
4. Turn on the board power switch.

*Note:* To ensure operating stability, keep the USB cable connected and the board powered on when running the demonstration application. The BTS cannot run correctly unless the USB cable is attached and the board is powered on.

Navigate to the `<package_dir>\examples\board_test_system` directory. The BTS release folder includes the following files.

Figure 5. BTS Folder

Name	Type
image	File folder
lib	File folder
BoardTestSystem.bat	Windows Batch File
BoardTestSystem.sh	Shell Script
bts.ini	Configuration settings
bts.jar	JAR File
ClockController.bat	Windows Batch File
ClockController.sh	Shell Script
PowerMonitor.bat	Windows Batch File
PowerMonitor.sh	Shell Script
README.TXT	Text Document

You can run BTS GUI easily with the following scripts.

1. On **Windows** system, double click the .bat files to run BTS, Clock Controller, or Power Monitor GUI.

Figure 6. Windows Console

```
C:\windows\System32\cmd.exe
+ BOARD TEST SYSTEM +
*****
Board Test System starting...
C:\board_test_system>"C:\Program Files\Java\jre\bin\java.exe" --module-path
"C:\Program Files\Java\jfx\lib" --add-modules javafx.controls,javafx.fxml,
javafx.web -jar bts.jar
Picked up _JAVA_OPTIONS: -Djava.net.preferIPv4Stack=true
Success!
Starting application on Windows 10...
```

2. On **Linux** system, you need to run the shell script with root privilege.

Figure 7. Linux Console

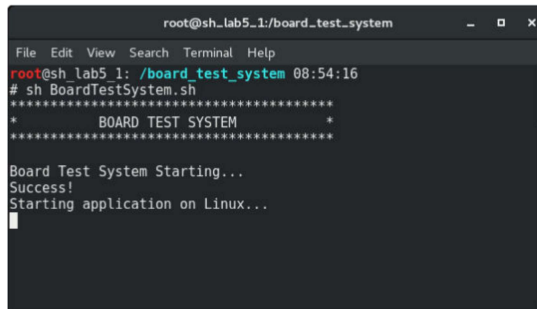

```
root@sh_lab5_1:/board_test_system
File Edit View Search Terminal Help
root@sh_lab5_1: /board_test_system 08:54:16
# sh BoardTestSystem.sh
*****
*          BOARD TEST SYSTEM          *
*****
Board Test System Starting...
Success!
Starting application on Linux...
```

**Note:** The .bat or shell script checks the Java environment settings, copy necessary files, and give some prompts if the environment is not set up correctly.

The GUI displays the application tab corresponding to the design running in the FPGA. If the design loaded in the FPGA is not supported by the BTS GUI, you receive a message prompting you to configure your board with a valid BTS design. For more information, refer to the *Configure Menu* section.

## 4.2. Test the Functionality of the Development Kit

This section describes each control in the BTS.

### 4.2.1. The Bottom Info Bar

The bottom information bar shows the status of the system connection, the Intel Quartus Prime version and the JTAG clock.

- **System Connected/Disconnected:** Shows if the board is connected to the system. The green sign turns gray if the board becomes disconnected.
- **Intel Quartus Prime Version:** Displays the current Intel Quartus Prime version installed and active on your system. The text turns red if your version is older than the required version. Change the `QUARTUS_ROOTDIR` environment variable if you have installed the right version but the active version doesn't meet the requirement.
- **JTAG:** Displays the JTAG clock frequency.

### 4.2.2. The Configure Menu

Use the Configure Menu to select the design you want to use. Each design example tests different functionality that corresponds to one or more application tabs.



Figure 8. The Configure Menu

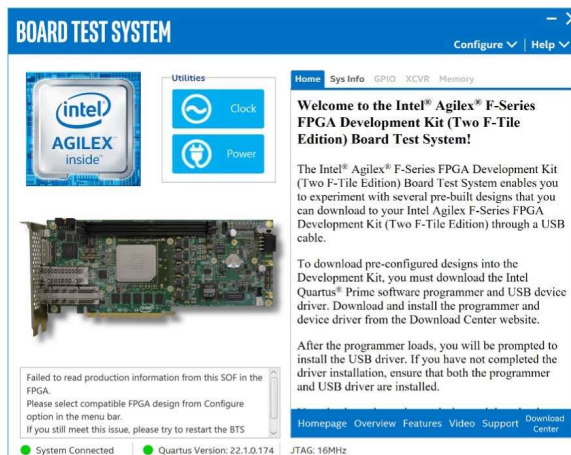

To configure the FPGA with a test system design, follow these steps:

1. On the **Configure** menu, click the **Configure** command that corresponds to the functionality you want to test.
2. In the dialog box that appears, click **Configure** to download the corresponding design's SRAM Object File (.sof) to the FPGA. The download process usually takes less than a minute.
3. When configuration finishes, the design begins running in the FPGA. The corresponding GUI application tabs that interface with the design are now enabled. If you use the Intel Quartus Prime Programmer for configuration, instead of the BTS GUI, you need to restart the GUI.

### 4.2.3. The Sys Info Tab

The **Sys Info** tab shows information about the board's current configuration. The tab displays the board information, JTAG Chain devices and other details stored on the board.

Figure 9. The Sys Info Tab

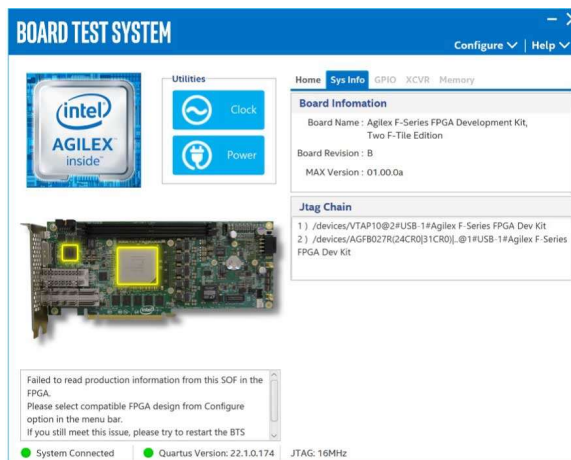

The following sections describe the controls on the System Info tab.

### Board Information

The board information control displays static information about your board.

- **Board Name:** Indicates the official name of the board given by the BTS.
- **Board Revision:** Indicates the revision of the board.
- **MAX Version:** Indicates the version of the system Intel MAX 10.

### JTAG Chain

The JTAG chain control shows all the devices currently in the JTAG chain.

*Note:* Both System Intel MAX 10 and FPGA must be in the JTAG chain when running the BTS GUI.

## 4.2.4. The GPIO Tab

The **GPIO** tab allows you to interact with all the general-purpose user I/O components on your board. You can turn LEDs on or off and detect I<sup>2</sup>C target devices connection status.

Figure 10. The GPIO Tab

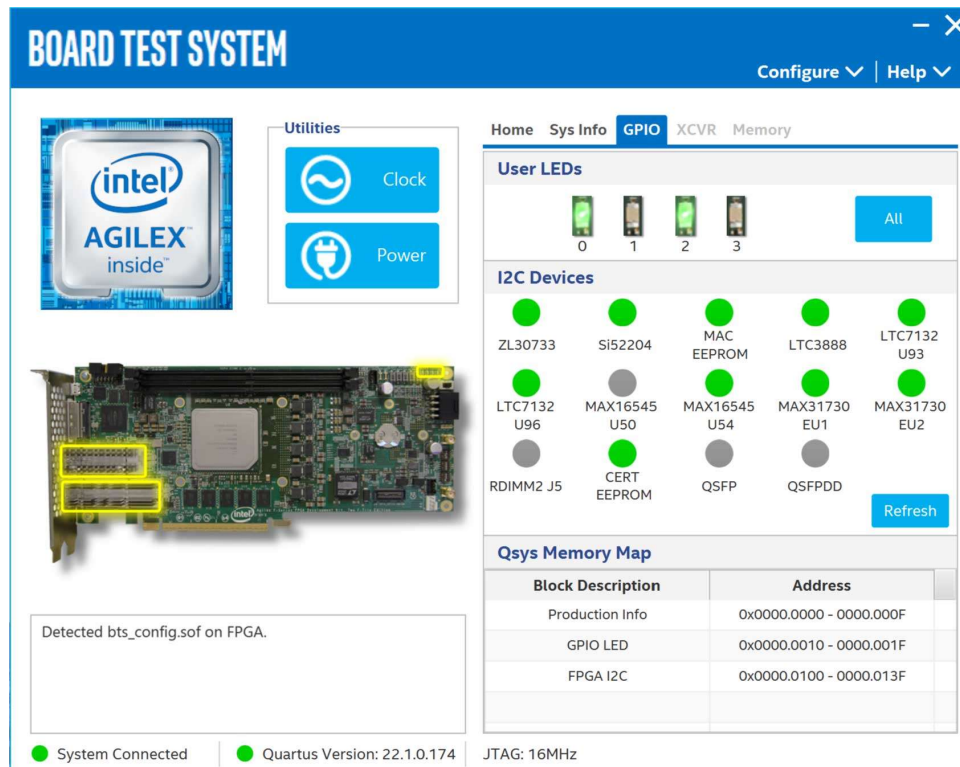

The following sections describe the controls on the GPIO tab.

### User LEDs

The User LEDs control displays the current state of the user LEDs. Toggle the LED buttons to turn the board LEDs on and off. Click the All button to reverse the state of all the LEDs.

### I<sup>2</sup>C

The read-only I<sup>2</sup>C target device control displays the connection status of some devices, which can be accessed by I<sup>2</sup>C bus. The status of QSFP and QSFPDD modules can be updated in real time.

### Platform Designer Memory Map

The Platform Designer Memory Map control shows the memory map of **bts\_config.sof** design running on your board.

## 4.2.5. The XCVR Tab

The **XCVR** tab allows you to run transceiver tests on your board. You can run the test using either electrical loopback modules or optical fiber modules.

### 4.2.5.1. The QSFP NRZ Tab

Figure 11. The QSFP NRZ Tab

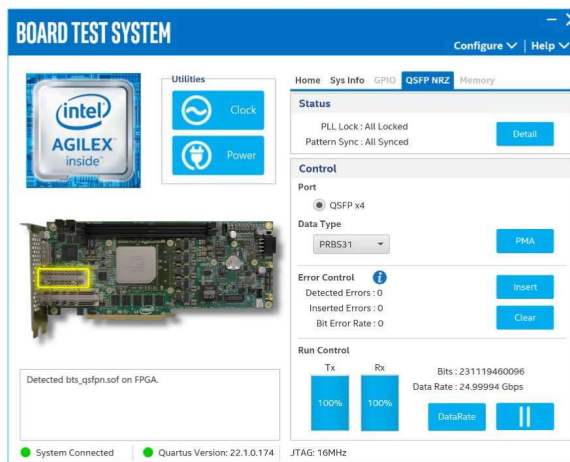

The following sections describe controls in the QSFP NRZ tab.

#### Status

The Status control displays the following status information during the loopback test:

- **PLL Lock:** Shows the PLL locked or unlocked state.
- **Pattern Sync:** Shows the pattern synced or not state. The pattern is considered synced when the start of the data sequence is detected.
- **Detail:** Shows the PLL lock and pattern sync status of each channel. The number of the error bits of each channel can be found here.

### PMA Setting

Allows you to make changes to the PMA parameters that affect the active transceiver interface. The following settings are available for analysis:

- **Serial Loopback:** Displays the signal status between the transmitter and the receiver.
- **VOD:** Specifies the voltage output differential of the transmitter buffer.
- **Pre-emphasis tap:**
  - Pre-tap 1: Specifies the amount of pre-emphasis on the first pre-tap of the transmitter buffer.
  - Pre-tap 2: Specifies the amount of pre-emphasis on the second pre-tap of the transmitter buffer.
  - Post-tap 1: Specifies the amount of pre-emphasis on the post-tap of the transmitter buffer.

Figure 12. QSFP NRZ-PMA Setting

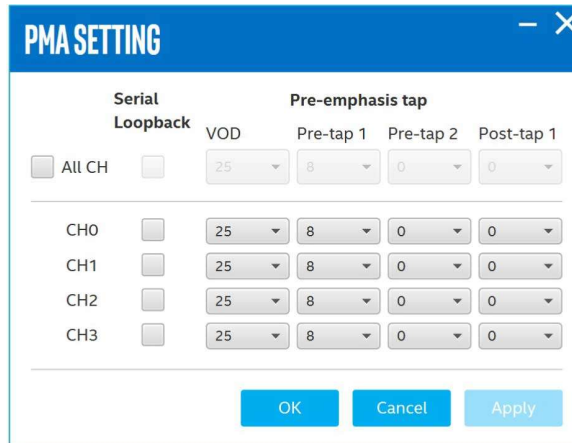

### Data Type

The Data Type control specifies the type of data pattern contained in the transactions. Select the following available data types for analysis:

- **PRBS7:** pseudo-random 7-bit binary sequences
- **PRBS15:** pseudo-random 15-bit binary sequences
- **PRBS23:** pseudo-random 23-bit binary sequences
- **PRBS31:** pseudo-random 31-bit binary sequences (default)

### Error Control

This control displays data errors detected during analysis and allows you to insert errors:

- **Detected Errors:** Displays the number of data errors detected in the received bit stream.
- **Inserted Errors:** Displays the number of errors inserted into the transmit data stream.
- **Bit Error Rate:** Calculates the bit error rate of the transmit data stream.
- **Insert:** Insert a one-word error into the transmit data stream each time you click the button. Insert Error is only enabled during transaction performance analysis.
- **Clear:** Resets the Detected Errors counter and Inserted Errors counter to zeros.

### Run Control

- **TX and RX performance bars:** Show the percentage of maximum theoretical data rate that the requested transactions can achieve.
- **Start:** This control initiates the loopback tests.
- **Data Rate:** Displays the XCVR type and data rate of each channel.

Figure 13. QSFP NRZ - Data Rate

Channel	XCVR Type	Frequency
0	F-Tile FGT	24.99994 Gbps
1	F-Tile FGT	24.99994 Gbps
2	F-Tile FGT	24.99994 Gbps
3	F-Tile FGT	24.99994 Gbps

#### 4.2.5.2. The QSFP PAM4 Tab

Similar control functions with the QSFP NRZ tab.

Figure 14. The QSFP PAM4 Tab

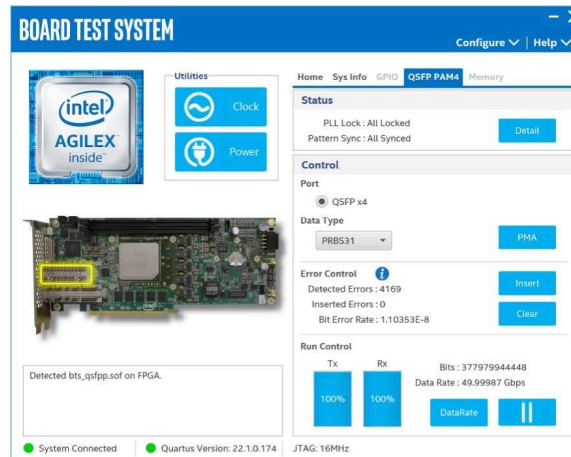

#### 4.2.5.3. The QSFPDD NRZ Tab

Similar control functions with the QSFP NRZ tab.

Figure 15. The QSFPDD NRZ Tab

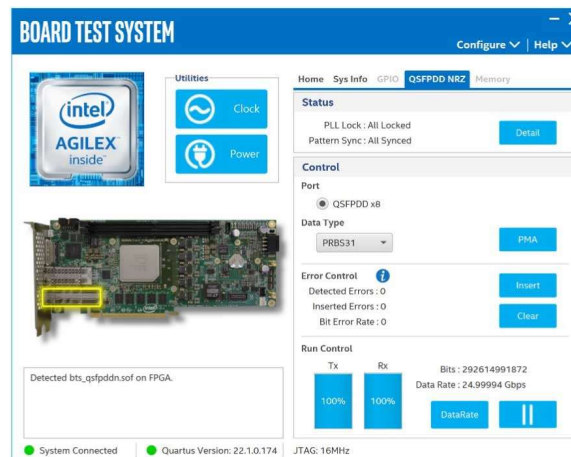

#### 4.2.5.4. The QSFPDD PAM4 Tab

Similar control functions with the QSFP NRZ tab.

Figure 16. The QSPFDD PAM4 Tab

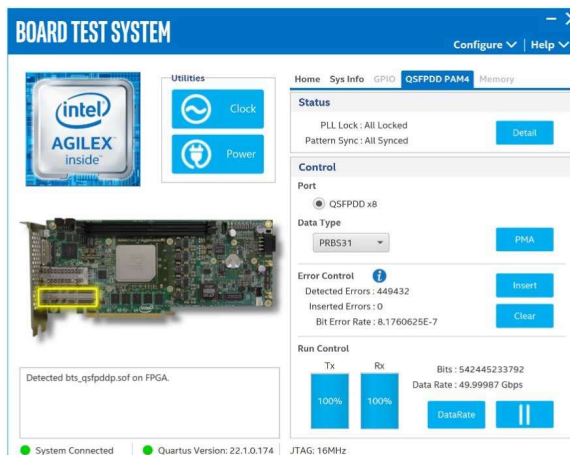

### 4.2.6. The Memory Tab

This tab allows you to read and write DDR4 DIMM1 and DDR4 DIMM2 memory on your board. Download the design through BTS Configure.

Figure 17. The RDIMM1 Tab

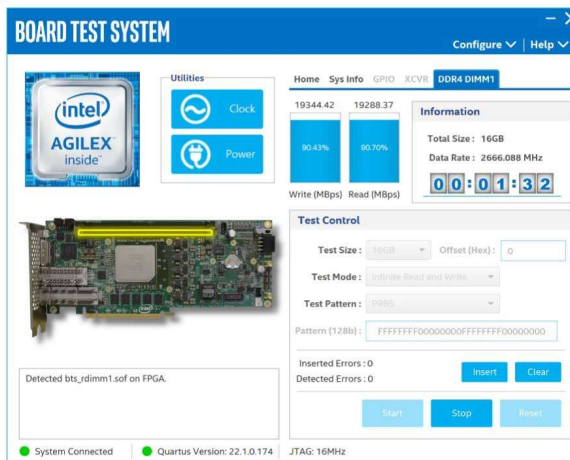

The following sections describe controls on this tab.

#### Start

Initiates DDR4 memory transaction performance analysis.

#### Stop

Terminates transaction performance analysis.

### Performance Indicators

These controls display current transaction performance analysis information collected since you last clicked **Start**:

- **Write and Read performance bars**: Show the percentage of maximum theoretical data rate that the requested transactions can achieve.
- **Write (MBps) and Read (MBps)**: Show the number of bytes analyzed per second.
- **Data Bus**: 72 bits (8 bits ECC) wide, reference clock is 166.666 MHz, and the frequency is 1333.33 MHz double data rate 2666.66 MT/s.

### Test Control

- **Test Size**: You can choose the size of the memory to test. The available options are 64 KB, 256 KB, 1 MB, 4 MB, 16 MB, 64 MB, 256 MB, 1 GB, 4 GB, 8 GB, and 16GB (default).
- **Offset (Hex)**: You can define the memory start address to test.
- **Test Mode**: Infinite Read and Write (default), Single Read and Write.
- **Test Pattern**: PRBS (default), User Defined Constant, Walking '0', Walking '1'.

### Error Control

This control displays data errors detected during analysis and allows you to insert errors:

- **Detected Errors**: Displays the number of data errors detected in the hardware.
- **Inserted Errors**: Displays the number of errors inserted into the transaction stream.
- **Bit Error Rate**: Calculates the bit error rate of the transmit data stream.
- **Insert**: Insert a one-word error into the transaction stream each time you click the button. Insert error is only enabled during transaction performance analysis.
- **Clear**: Resets the Detected Errors counter and Inserted Errors counter to zeros.

**Figure 18. The RDIMM2 Tab**

Similar with RDIMM1.

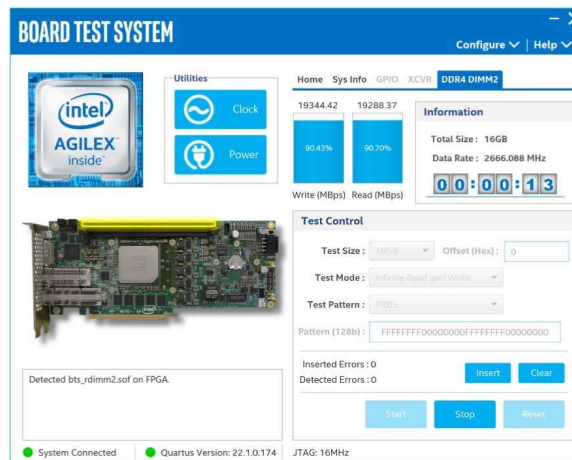



### 4.3. Control On-Board Clock through Clock Controller GUI

The Clock Controller GUI can change the on-board programmable PLLs to a large range of customized frequency. The instructions to run Clock Controller GUI are stated in the *Run BTS GUI* section. You can also start it using the BTS GUI icon “Clock”.

The clock controller communicates with the system Intel MAX 10 device through a 10-pin JTAG header **J3** or Micro-USB connector **J10**. Then, system Intel MAX 10 controls these programmable clock parts through a 2-wire I<sup>2</sup>C bus.

*Note:* You cannot run the stand-alone Clock Controller GUI application when the BTS or Power Monitor GUI is running at the same time.

**Figure 19. ZL30733**

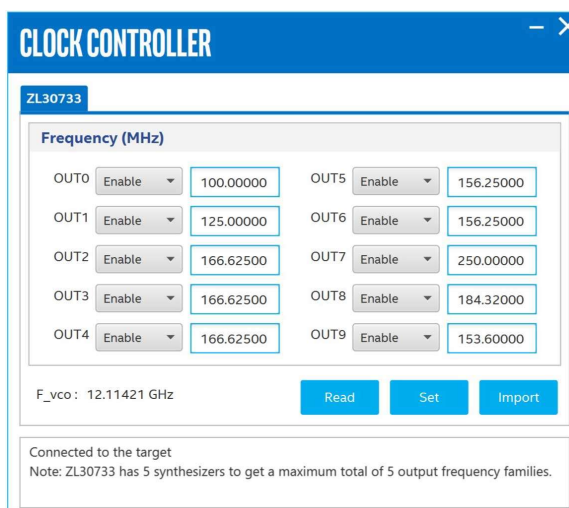

The output frequency of ZL30733 is from 0.5 Hz to 750 MHz. It can generate up to 10 differential outputs with a total of 5 output frequency families. The following sections describe the Clock Controller buttons.

#### Read

Reads the current frequency setting for the oscillator associated with the active tab.

#### Set

Sets the programmable oscillator frequency for the selected clock to the value in the `OUTx` output controls for ZL30733. Frequency changes might take several milliseconds to take effect. You might see glitches on the clock during this time. Intel recommends resetting the FPGA logic after changing frequencies.

### Import

ZL30733 has a multiple time writable non-volatile memory (NVM). You can generate the register list with the following format:

- **Register Write Command Line:** X , <register\_address> , <data\_bytes>— <register\_address> and <data\_bytes>, whose prefix must be "0x" are in hexadecimal
- **Wait Command Line:** W , <time\_microseconds>

Import it into ZL30733 to update the settings of the NVM. Register changes are volatile after power cycling. For more details, refer to [ZL30733 on the Microchip website](#).

## 4.4. Monitor On-Board Power Regulator through Power Monitor GUI

The Power Monitor GUI reports most power rails' voltage, current, and power information on the board. It also collects temperature from FPGA die, power modules, and diodes assembled on PCB.

The Power Monitor GUI communicates with system Intel MAX 10 through a 10-pin JTAG header **J3** or USB port **J10**. System Intel MAX 10 monitors and controls power regulator, temperature/voltage/current sensing chips through a 2-wire I<sup>2</sup>C bus.

The instructions to run Power Monitor GUI are stated in the *Run BTS GUI* section. It can also be started with the BTS GUI icon "Power".

*Note:* You cannot run the stand-alone Power Monitor GUI when the BTS or the Clock Controller GUI is running at the same time.

**Figure 20. Power Monitor GUI**

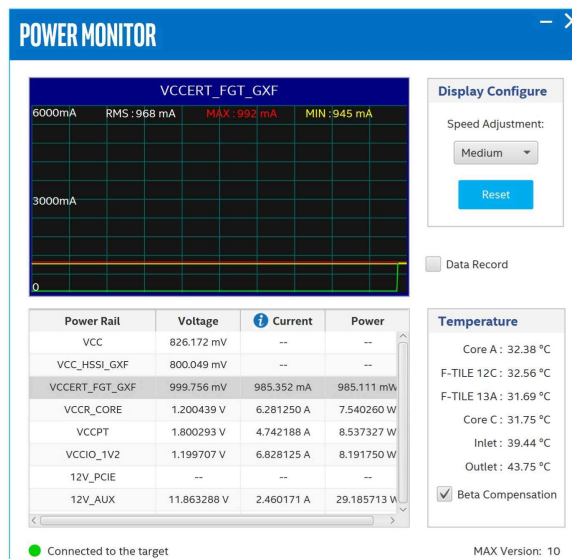

The following sections describe the details of the Power Monitor GUI.

### Display Configure

- **Speed Adjustment:** Adjusts the update rate of the current curve
- **Reset:** Regenerates the graph

### Data Record

When the box is checked, the telemetry data of the selected power rail can be recorded. The data will be saved into a .csv file in the `board_test_system/log` directory.

### Temperature

Reads the temperature data from FPGA die internal temperature sense diodes.

- **Beta Compensation:** Corrects the temperature-measurement errors due to low-beta sensing transistors

## 4.5. BTS Test Areas

BTS checks for hardware fault before you can use the board. If one or more BTS test items fail, it implies either a wrong hardware setting or hardware fault on specific interface.

## 4.6. Identify Test Pass- or Fail-based on BTS GUI Test Status

### QSFP

Plug QSFP loopback module in **J8** before you configure QSFP NRZ/PAM4 example build through BTS GUI.

### QSFPDD

Plug QSFPDD loopback module in **J7** before you configure QSFPDD NRZ/PAM4 example build through BTS GUI.

### DDR4 DIMM

Plug the DDR4 DIMM module which is shipped alone with this development kit in **J4/J5**. BTS GUI only supports fabric memory interfaces, namely DDR4 DIMM1 and DDR4 DIMM2.

## 5. Development Kits Hardware and Configuration

---

The development board supports multiple configuration modes as listed in the following table. The default configuration is AS x4 (Fast) using a 2 Gb QSPI flash device.

**Table 5. Supported Configuration Modes**

Configuration Mode	MSEL2 SW3.2	MSEL1 SW3.2	MSEL0 (Pulled high)
JTAG	1	1	1
Avalon-ST x16	1	0	1
AS x4 (Fast) (Default)	0	0	1
AS x4 (Normal)	0	1	1

### 5.1. JTAG Configuration Mode

When MSEL[2:1] are both set to logic high by DIP switch SW3[2:1] = [OFF:OFF], the configuration mode defaults to JTAG.

### 5.2. Active Serial (AS) x4 Configuration Mode

The AS x4 configuration mode can be set to either fast or normal mode. When the AS x4 mode is enabled, the FPGA configures itself after power-on with the programming file stored within the QSPI flash (**U9**) connected directly to the FPGA SDM interface. In this mode, the FPGA downloads its programming bitstream directly from the QSPI flash device. This is the default configuration mode for the board shipped from the factory.

### 5.3. Avalon-ST x16 Configuration Mode

When set to the Avalon-ST x16 mode, the Intel MAX 10 System Controller (**U5**) acts as the configuration host to manage configuration download. After power on, the Intel MAX 10 reads the configuration bitstream programmed into the QSPI flash (**U4**) and sends this data to FPGA SDM interface to program the FPGA. The **U4** is a 2 Gb QSPI flash device, allowing for four FPGA images to be stored. Image download selection is controlled by jumpers **J105** and **J106** as listed in the following table. The default image to be programmed is image 0.

*Note:* Do not use **U3**, it is just hardware backup for future use.

**Table 6. Image Download Selection**

<b>Image Selection</b>	<b>J106</b>	<b>J105</b>	<b>Notes</b>
Image 0	Installed	Installed	Image 0—Default
Image 1	Open	Installed	Image 1
Image 2	Installed	Open	Image 2
Image 3	Open	Open	Image 3

## 6. Custom Projects for the Development Kit

---

### 6.1. Add SmartVID Settings in the Intel Quartus Prime QSF File

By default, the Intel Agilex silicon assembled on this development kit enables the SmartVID feature. To avoid the Intel Quartus Prime software from generating an error due to incomplete SmartVID settings, you must put constraints outlined below into the Intel Quartus Prime project QSF file.

Open your Intel Quartus Prime project QSF file, copy and paste the following constraint scripts into the file. Ensure there are no other similar settings with different values.

```
set_global_assignment -name PWRMGT_SLAVE_DEVICE_TYPE LTC3888
set_global_assignment -name PWRMGT_SLAVE_DEVICE0_ADDRESS 55
set_global_assignment -name PWRMGT_VOLTAGE_OUTPUT_FORMAT "LINEAR FORMAT"
set_global_assignment -name PWRMGT_LINEAR_FORMAT_N "-12"
set_global_assignment -name PWRMGT_PAGE_COMMAND_ENABLE ON
set_global_assignment -name PWRMGT_PAGE_COMMAND_PAYLOAD 0
set_global_assignment -name USE_PWRMGT_SCL SDM_IO0
set_global_assignment -name USE_PWRMGT_SDA SDM_IO11
set_global_assignment -name USE_CONF_DONE SDM_IO16
set_global_assignment -name USE_INIT_DONE SDM_IO13
set_global_assignment -name USE_CVP_CONFDONE SDM_IO14
set_global_assignment -name USE_NCATTRIP SDM_IO12
set_global_assignment -name USE_HPS_COLD_RESET SDM_IO10
```

### 6.2. Golden Top

You can use the Golden Top project as the starting point for your designs. It comes loaded with constraints, pin locations, defined I/O standard, direction, and general termination.

## 7. Revision History

---

**Table 7. Revision History for the Intel Agilex F-Series FPGA (Two F-Tiles) Development Kit User Guide**

Document Version	Changes
2022.09.21	Initial release.

## A. Development Kit Components

### A.1. Board Overview and Components

This section describes all the important components on the development board. A complete set of schematics, a physical layout database, and GERBER files for the development board reside in the development kit documents directory.

#### A.1.1. Board Overview

**Figure 21. Intel Agilex FPGA Development Kit, 2 F-tile Edition (Top View)**

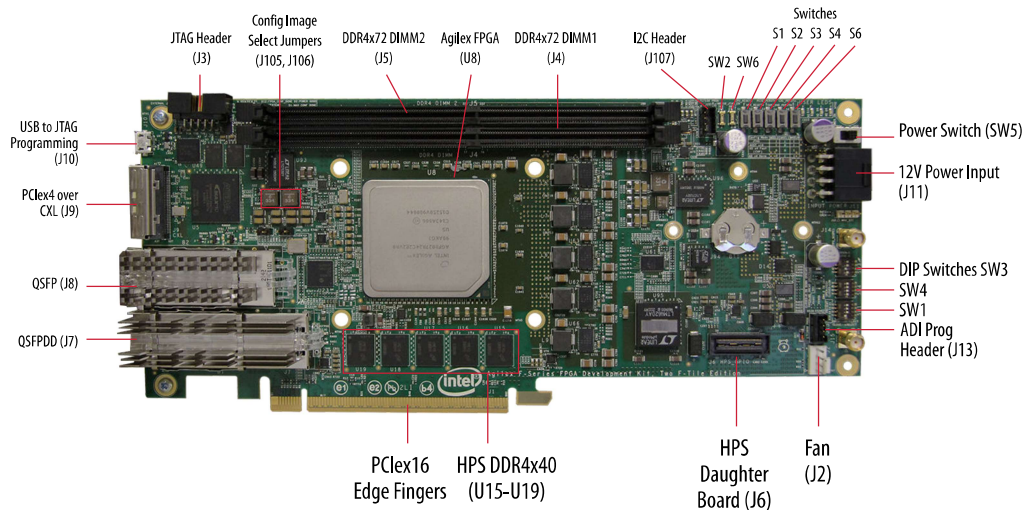

#### A.1.2. Board Components

**Table 8. Featured Devices**

Board Reference	Type	Description
U8	FPGA	Intel Agilex FPGA, AGFB027R24C2E2V <ul style="list-style-type: none"> <li>• 2,692,760 Logic Elements (LE)</li> <li>• 912,800 Adaptive Logic Elements (ALM)</li> <li>• 13,272 M20K Blocks</li> <li>• 45,640 MLABs</li> <li>• 8,528 DSP Blocks</li> <li>• 17,056 18x19 Multipliers</li> <li>• 744 GPIOs</li> <li>• 372 LVDS</li> </ul>

*continued...*

Intel Corporation. All rights reserved. Intel, the Intel logo, and other Intel marks are trademarks of Intel Corporation or its subsidiaries. Intel warrants performance of its FPGA and semiconductor products to current specifications in accordance with Intel's standard warranty, but reserves the right to make changes to any products and services at any time without notice. Intel assumes no responsibility or liability arising out of the application or use of any information, product, or service described herein except as expressly agreed to in writing by Intel. Intel customers are advised to obtain the latest version of device specifications before relying on any published information and before placing orders for products or services.

\*Other names and brands may be claimed as the property of others.



Board Reference	Type	Description
		<ul style="list-style-type: none"> <li>32 x 32 Gbps Transceivers</li> <li>24 x 58Gbps Transceivers</li> <li>2340 pin BGA Package</li> </ul>
U5	CPLD	Intel MAX 10 CPLD, 10M50DAF256I7G

**Table 9. Configuration and Setup Elements**

Board Reference	Type	Description
J10	On-board Intel FPGA Download Cable II	Micro-USB 2.0 connector for programming and debugging the FPGA.
SW1	PCIe control DIP switch	Enables PCIe link widths x1, x4, x8, and x16.
SW2	Intel FPGA Download Cable II selection switch	Selects between the on-board Intel FPGA Download Cable II or external Intel FPGA Download Cable II connected to J3 header.
SW3 Position 1-2	JTAG bypass DIP switch	Enables and disables devices in the JTAG chain.
SW3 Position 3-4	MSEL configuration DIP switch	Sets the Intel Agilex MSEL configuration modes
SW4	PCIe clock control DIP switch	Provides control for PCIe clock controls such as Spread Spectrum enable/disable, local or external PCIe clock source, and PCIe REFCLK power down.
SW5	Power-on slide switch	Main switch for powering on the Board when used in bench-top mode. This switch is ignored when the board is used in a PCIe system.
SW6	Intel MAX 10 JTAGEN switch	Enables Intel MAX 10 to use the JTAG pins as I/Os.
S1	CPU RESETn	Sends an active low signal to the FPGA and Intel MAX 10 which can be used as the RESET for internal designs.
S2	HPS RESETn	Sends an active low signal to the Intel MAX 10. Intel MAX 10 can then send HPS_DC_RSTn to the HPS IO48 daughter card is present.
S3	1st_PCIe_PERSTN push-button	Sends an active low signal to the dedicated PCIe_PERSTN pin of transceiver Bank 13A.
S4	2nd_PCIe_PERSTN push-button	Sends an active low signal to a GPIO pin in Bank 3A. This pin can be used as a secondary PERSTN signal.
S6	CXL_PCIe_PERSTN push-button	Sends an active low signal to the CXL connector PERSTN pin.
J105	Configuration image selection	Use together with J106 to select image stored in <b>U4</b> for Avalon-ST x16.
J106	Configuration image selection	Use together with J105 to select image stored in <b>U4</b> for Avalon-ST x16.

**Table 10. Status Elements**

Board Reference	Type	Description
D1	Green Intel MAX 10 CONF_DONE LED	LED is on when the Intel MAX 10 is successfully configured.
D2	Blue power good LED	LED is on when Intel MAX 10 detects that all power on the board is good.

*continued...*

Board Reference	Type	Description
D5	Red over temperature LED	LED is on when the Intel MAX 10 detects an over-temperature condition on the board.
D12	Green FPGA CONF_DONE LED	LED is on when the FPGA is successfully configured.
D[11:D8]	4 green user LEDs	FPGA connected LEDs for user designs.
D[25:24]	2 green configuration image LEDs	Indicates which FPGA configuration image is loaded.

**Table 11. Clock Circuits**

Board Reference	Type	Description
U23	ZL30733 IEEE 1588 clock device I <sup>2</sup> C programmable by Intel MAX 10	Default frequencies: <ul style="list-style-type: none"> <li>• Out 0: 100 MHz</li> <li>• Out 1: 125 MHz</li> <li>• Out 2: 166.25 MHz</li> <li>• Out 3: 166.25 MHz</li> <li>• Out 4: 166.25 MHz</li> <li>• Out 5: 156.25 MHz</li> <li>• Out 6: 156.25 MHz</li> <li>• Out 7: 250 MHz</li> <li>• Out 8: 184.32 MHz</li> <li>• Out 9: 153.6 MHz</li> </ul>
U25, U26, U27	PCIe reference clocks <ul style="list-style-type: none"> <li>• U25: I<sup>2</sup>C programmable by Intel MAX 10 local</li> <li>• U26, U27: PCIe fan-out clock buffers</li> </ul>	Default frequencies: <ul style="list-style-type: none"> <li>• U25:                             <ul style="list-style-type: none"> <li>— Out 0: Local 100 MHz PCIe to U26</li> <li>— Out 1: Local 100 MHz PCIe to U27</li> <li>— Out 2: 100 MHz CXL PCIe root port clock to CXL connector J9</li> </ul> </li> <li>• U26:                             <ul style="list-style-type: none"> <li>— Out 0: 100 MHz PCIe Bank 13A, CH5</li> <li>— Out 1: 100 MHz PCIe Bank 13A, CH2</li> </ul> </li> <li>• U27:                             <ul style="list-style-type: none"> <li>— Out 0: 100 MHz PCIe Bank 12C, CH0</li> <li>— Out 1: 100 MHz PCIe Bank 12C, CH1</li> </ul> </li> </ul>

**Table 12. Transceiver Interfaces**

Board Reference	Type	Description
J1	PCIe x16 gold fingers	PCIe TX/RX x16 interface from FPGA Bank 13A.
J7, B1	QSFPDD-56 pluggable optics interface	8 TX/RX channels from FPGA Bank 12C, Quad2 and Quad3.
J8, B2	QSFP-56 pluggable optics interface	4 TX/RX channels from FPGA Bank 12C, Quad1.
J9	PCIe x4 over CXL connector	PCIe TX/RX x4 interface from FPGA Bank 12C, Quad0.

**Table 13. Memory Devices**

Board Reference	Type	Description
J4	DDR4 DIMM1 connector	DDR4 x72 DIMM module installed by default.
J5	DDR4 DIMM2 connector	No DDR4 DIMM module installed by default.
U15–U19	DDR4 components	DDR4 x40 interface for HPS.
U3, U4	2 x 2 Gbit QSPI flash	FPGA Avalon-ST x16 configuration flash memory.
<i>continued...</i>		

Board Reference	Type	Description
U9	2 Gbit QSPI flash	FPGA AS x4 configuration flash memory.
U45	64 Mbit serial nor flash	Intel MAX 10 Nios II flash.
U44	128 Kbit I <sup>2</sup> C EEPROM	MAC address EEPROM.
U46	128 Kbit I <sup>2</sup> C EEPROM	Security certificate EEPROM.

**Table 14. Communication Ports**

Board Reference	Type	Description
J3	10-pin JTAG header	For connecting an external Intel FPGA Download Cable II dongle.
J10	Micro-USB connector	For connecting to the on-board Intel FPGA Download Cable II.

**Table 15. Miscellaneous Ports**

Board Reference	Type	Description
J2	FAN header	4-pin FAN header
J13	LTC3888 (U61) programming header	Programming header for LTC3888 VCC Core, VCC_HSSI voltage regulator
J107	LTC7132 (U93, U96) programming header	Programming header for U93 (LTC7132 VCCERT_FGT_GXF, VCCR_CORE) and U96 (LTC7132 VCC_PT, VCCIO_1V2)

**Table 16. Power Supplies**

Board Reference	Type	Description
J11	12V_AUX power connector	8-pin 12V_AUX input power connector
U50	MAX16545B device	Input power conditioner for 12V_PCIE
U54	MAX16545B device	Input power conditioner for 12V_AUX
U94	Analog devices LTM4625	5V DC-DC voltage regulator
U56	Intersil ISL80101	2.5V LDO voltage regulator
U57	Intersil ISL80101	1.8V LDO voltage regulator
U58	Intersil ISL80101	1.2V LDO voltage regulator
U95	Analog devices LTM4620A	3.3V DC-DC voltage regulator
U60, Q18	Analog devices LTC1981, pass FET	3.3V_SYS voltage
U61, U62-U65	Analog devices LTC3888 multiphase controller and FET power stage	0.8V VCC core VID voltage regulator
U61, U66	Analog devices LTC3888 multiphase controller and FET power stage	0.8V VCC_HSSI_GXF voltage regulator
U80	Intersil ISL80101	0.9V VCCH_SDM LDO voltage regulator
U93	Analog devices LTC7132 dual-output regulator	1.0V VCCERT_FGT_GXF voltage regulator
		1.2V VCCR_CORE voltage regulator
U96	Analog devices LTC7132 dual-output regulator	1.8V VCCPT voltage regulator
		1.2V VCCIO_1V2 voltage regulator
U70	Intersil ISL80101	1.0V VCCFUSEWR_GXF LDO voltage regulator

*continued...*

Board Reference	Type	Description
D28	LT1389 VREF generation	1.25V VREF for VCCBAT
U74	Intersil ISL80101	1.8V VCCIO_SDM_HPS LDO voltage regulator
U75	Intersil ISL80101	2.5V DDR4 DIMM LDO voltage regulator
U76	Intersil ISL80101	2.5V DDR4 COMP LDO voltage regulator
U77	Texas Instruments TPS51200	0.6V DDR4 DIMM VTT/VREF generation
U78	Texas Instruments TPS51200	0.6V DDR4 COMP VTT/VREF generation

### A.1.3. Intel MAX 10 CPLD System Controller

The development board utilizes the 10M50 system controller, an Intel MAX 10 CPLD for the following purposes:

- Power sequencing control
- FPGA configuration from flash memory
- On-board Intel FPGA Download Cable II
- Power monitoring
- Temperature monitoring
- Fan control
- Clock control

### A.2. FPGA Configuration

You can use the Intel Quartus Prime Programmer to configure the FPGA with your SRAM Object File (**.sof**).

Ensure the following:

- The Intel Quartus Prime Programmer and the Intel FPGA Download Cable II driver are installed on the host computer.
- The micro-USB cable is connected to the FPGA development board.
- Power to the board is ON, and no other applications that use the JTAG chain are running.

To configure the FPGA, follow these steps:

1. Start the Intel Quartus Prime Programmer.
2. Click **Auto Detect** to display the devices in the JTAG chain.
3. Click **Change File** and select the path to the desired **.sof**.
4. Turn on the **Program/Configure** option for the added file.
5. Click **Start** to download the selected file to the FPGA. Configuration is complete when the progress bar reaches 100%.

Using the Intel Quartus Prime Programmer to configure a device on the board causes other JTAG based applications such as the Board Test System and the Power Monitor to lose their connection to the board. Restart those applications after configuration is complete.

### A.2.1. Programming the FPGA over On-Board Intel FPGA Download Cable II

The figure below shows the high-level conceptual block diagram for programming the Intel Agilex FPGA over the on-board Intel FPGA Download Cable II.

Figure 22. Programming the FPGA over On-Board Intel FPGA Download Cable II Block Diagram

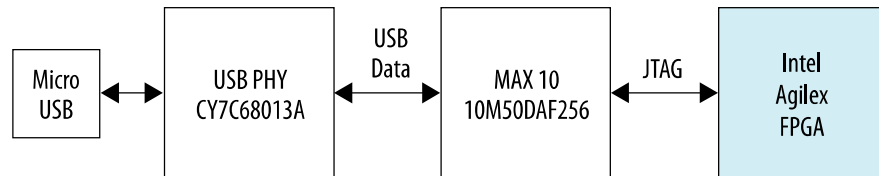

### A.2.2. Programming the FPGA over an External Intel FPGA Download Cable II

The figure below shows the high-level conceptual block diagram for programming the Intel Agilex FPGA over an external Intel FPGA Download Cable II.

Figure 23. Programming the FPGA over an External Intel FPGA Download Cable II Block Diagram

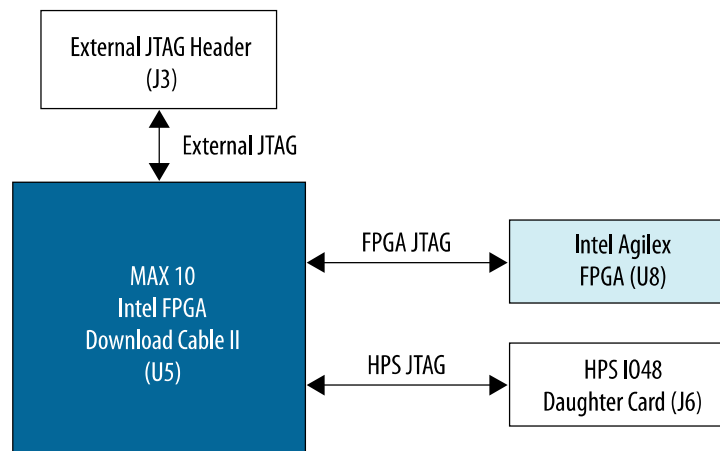

## A.3. Default Switch and Jumper Settings

This section shows you how to restore the default factory settings and explains their functions.

Figure 24. Switch and Jumper Locations

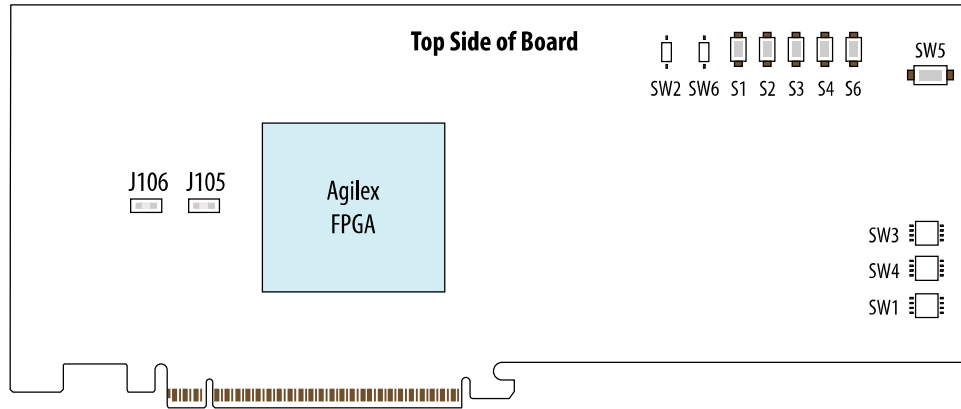

### A.3.1. Switch Description

Table 17. SW1–4 Position DIP for PCIe Lane Width Selection

Switch position	Board Label	Function	Default Position
1	x16	ON for PCIe x16	ON
2	x8	ON for PCIe x8	OFF
3	x4	ON for PCIe x4	OFF
4	x1	ON for PCIe x1	OFF

Table 18. SW2—Single DIP for Intel FPGA Download Cable II Selection

Switch position	Board Label	Function	Default Position
SW2	USB MAX JTAG SEL	ON for on-board Intel FPGA Download Cable II	ON
		OFF for external Intel FPGA Download Cable II	

Table 19. SW3–4 position DIP for Configuration Mode Selection and JTAG Control

By default, MSEL[2:0] is set to '001' for AS x4 with CvP support. MSEL0 is tied to logic high.

Switch position	Board Label	Function	Default Position
1	MSEL1	Configuration MSEL1	ON
2	MSEL2	Configuration MSEL2	ON
3	BMC JTAG SEL	ON Selects On-board Blaster	ON
4	HPS JTAG BYPASS	OFF Bypass HPS JTAG	OFF

The board only supports the following configuration modes.

**Table 20. Supported Configuration Modes**

MSEL0 is tied to logic high.

Configuration Mode	MSEL2	MSEL1	MSEL0
JTAG	1	1	1
Avalon-ST x16	1	0	1
AS x4 Fast (CVP support)	0	0	1
AS x4 Normal	0	1	1

**Table 21. SW4**

Switch position	Board Label	Function	Default Position
1	SSEN	ON enables PCIe Spread Spectrum	OFF
2	CXL REFCLK Select	ON for local PCIe REFCLK on Bank12C	OFF
3	PCIe REFCLK Select	ON for local PCIe REFCLK on Bank13A	OFF
4	PCIe Clock Power-down	On powers down PCIe clock sources	OFF

**Table 22. SW5—Slide Switch to Power On the Board**

Switch position	Board Label	Function	Default Position
SW5	Power On	ON to power on the board	OFF

**Table 23. SW6—Single DIP for Intel MAX 10 JTAG Enable**

Switch position	Board Label	Function	Default Position
SW6	Intel MAX 10 JTAG Enable	ON to share Intel MAX 10 JTAG Pins	OFF

**Table 24. S[1–4, 6]—Various Push-Button RESET Switches**

Switch	Function
S1	Used to send RESET to CPU
S2	Used to send RESET to HPS
S3	Used to send PERSTN to PCIe
S4	Used to send 2nd PERSTN to PCIe
S6	Used to send PERSTN to CXL PCIe

### A.3.2. Jumper Description

In Avalon-ST x16 configuration mode, the board provides one QSPI flash for storing up to four configuration images. Configuration of the FPGA with one of these images is managed by the Intel MAX 10, depending on the selection of jumpers **J105** and **J106**.

**Table 25. Selected Configuration Image**

J106	J105	Selected Configuration Image
ON	ON	Image 0 (Default)
ON	OFF	Image 1
OFF	ON	Image 2
OFF	OFF	Image 3

## A.4. Input and Output Components

### A.4.1. Push Buttons

The Intel Agilex FPGA (two F-tiles) development board includes several dedicated push buttons for you. When you press and hold down the button, the device pin is set to logic 0. When you release the button, the device pin is set to logic 1. There are no board-specific functions for these general user push buttons.

**Table 26. Push Buttons**

Board Reference	Schematic Signal Name	I/O Standard
S1	CPU_RESETn	3.3V
S2	HPS_RESETn	3.3V
S3	PCIE_PERSTn	1.8V
S4	GFX_2ND_PERSTn	1.8V
S6	CXL_PERSTn	3.3V

### A.4.2. Switches

The Intel Agilex FPGA (two F-tiles) development board includes user-controlled switches for selecting various features on the board. When the switch is in the OFF position, logic 1 is selected. When the switch is in the ON position, logic 0 is selected.

**Table 27. Switches**

Board Reference	Schematic Signal Name	I/O Standard
SW1.1	PCIE_EP_PRSNT_Nx16	3.3V
SW1.2	PCIE_EP_PRSNT_Nx8	3.3V
SW1.3	PCIE_EP_PRSNT_Nx4	3.3V
SW1.4	PCIE_EP_PRSNT_Nx1	3.3V
SW2	USB_MAX_JTAG_SEL	3.3V
SW3.1	FPGA_1V8_MSEL1	1.8V
SW3.2	FPGA_1V8_MSEL2	1.8V
SW3.3	BMC_JTAG_EN	1.8V
SW3.4	HPS_JTAG_BYPASS	1.8V
SW4.1	SI52204_SSEN	1.8V
<i>continued...</i>		



Board Reference	Schematic Signal Name	I/O Standard
SW4.2	SEL_CXL_REFCLK	1.8V
SW4.3	SEL_PCIE_REFCLK	1.8V
SW4.4	SI52204_PWRDNB	1.8V
SW5	POWER_ON	2.5V
SW6	MAX10_JTAG_EN	3.3V

### A.4.3. LEDs

The Intel Agilex FPGA development board provides various LEDs for indicating board status information. The LEDs illuminate when a logic 1 is driven and turn OFF when a logic 0 is driven. There are no board-specific functions for these LEDs.

**Table 28. LEDs**

Board Reference	Schematic Signal Name	I/O Standard
D1	MAX_CONF_DONE	3.3V
D2	PWRGD_OUT	3.3V
D3	QSFPDD_LED2	1.2V
D4	QSFP_LED2	1.2V
D5	OVERTEMP_LEDn	3.3V
D6	QSFPDD_LED1	1.2V
D7	QSFP_LED1	1.2V
D8	FPGA_3V3_LED0	1.2V
D9	FPGA_3V3_LED1	1.2V
D10	FPGA_3V3_LED2	1.2V
D11	FPGA_3V3_LED3	1.2V
D12	FPGA_1V8_CONF_DONE	1.8V
D24	CFG_IMAGE0	3.3V
D25	CFG_IMAGE1	3.3V

## A.5. Components and Interfaces

This section describes the development board's communication ports and interface cards relative to the Intel Agilex FPGA device.

### A.5.1. PCI Express (PCIe) Interface

The Intel Agilex FPGA (two F-tiles) development board is designed to fit entirely into a PC motherboard with a x16 PCI Express slot that can accommodate a full height, 2-slot, ¾ length form factor add-in card. This interface uses the Intel Agilex FPGA's PCI Express hard IP block, saving logic resources for the user logic application. The PCI Express edge connector has a presence detect feature to allow the motherboard to determine if a card is installed.

The PCI Express interface supports auto-negotiating channel width from x1 to x4 to x8 to x16 by using PCIe Intel FPGA IP. You can also configure this board to a x1, x4, x8, or x16 interface through a DIP switch that connects the `PRSTn` pins for each bus width.

The PCI Express edge connector has a connection speed of 2.5 Gbps/lane for a maximum of 40 Gbps full-duplex (Gen 1), 5.0 Gbps/lane for maximum of 80 Gbps full-duplex (Gen 2), or 8.0 Gbps/lane for a maximum of 128 Gbps full-duplex (Gen 3), and 16.0 Gbps/lane for a maximum of 256 Gbps full-duplex (Gen 4).

The power for the board can be sourced entirely from the PC host when installed into a PC motherboard with the PC's 2x4 ATX auxiliary power connected to the 12V ATX inputs (**J11**) of the Intel Agilex FPGA (two F-tiles) development board. Although the board can also be powered by an externally supplied power supply for use on a lab bench, Intel recommends that you do not power up from both supplies at the same time. Ideal diode power sharing devices have been designed into this board to prevent damages or backcurrent from one supply to the other.

The `REFCLK_PCIE_EP_EDGE_P/N` signal is a 100 MHz differential input that is driven from the PC motherboard onto this board through the edge connector. This signal connects directly to a Intel Agilex FPGA `REFCLK` input pin pair using DC coupling. This clock is terminated on the motherboard. Therefore, no on-board termination is required. This clock can have spread-spectrum properties that change its period between 9.847 ps to 10.203 ps. The I/O standard is high-speed current steering logic (HCSL).

**Table 29. PCI Express (PCIe) Pin Assignments**

Edge Finger pin Number	Schematic Signal Name	FPGA Pin Number	I/O Standard	Description
A11	PCIE_3V3_EP_PERSTN	MAX10 (U5)	3V LVCMOS	Reset
A14	REFCLK_PCIE_EP_EDGE_N	Clock Buffer (U26)	LVDS	Motherboard reference clock
A13	REFCLK_PCIE_EP_EDGE_P	Clock Buffer (U26)	LVDS	Motherboard reference clock
B5	PCIE_3V3_EP_SMBCLK	FRUID EEPROM (U2)	1.8V	SMB clock
B6	PCIE_3V3_EP_SMBDAT	FRUID EEPROM (U2)	1.8V	SMB data
A1	PCIE_EP_PRSTN_N	—	—	Link with DIP switch (SW1)
B17	PCIE_EP_PRSTN_Nx1	—	—	Link with DIP switch (SW1)
B31	PCIE_EP_PRSTN_Nx4	—	—	Link with DIP switch (SW1)
B48	PCIE_EP_PRSTN_Nx8	—	—	Link with DIP switch (SW1)
B81	PCIE_EP_PRSTN_Nx16	—	—	Link with DIP switch (SW1)
B15	PCIE_EP_TX_N0	AG5	1.4 V PCML	Receive bus
<i>continued...</i>				



Edge Finger pin Number	Schematic Signal Name	FPGA Pin Number	I/O Standard	Description
B20	PCIE_EP_TX_N1	AH2	1.4 V PCML	Receive bus
B24	PCIE_EP_TX_N2	AM2	1.4 V PCML	Receive bus
B28	PCIE_EP_TX_N3	AT2	1.4 V PCML	Receive bus
B34	PCIE_EP_TX_N4	AY2	1.4 V PCML	Receive bus
B38	PCIE_EP_TX_N5	BD2	1.4 V PCML	Receive bus
B42	PCIE_EP_TX_N6	BH2	1.4 V PCML	Receive bus
B46	PCIE_EP_TX_N7	BM2	1.4 V PCML	Receive bus
B51	PCIE_EP_TX_N8	BT2	1.4 V PCML	Receive bus
B55	PCIE_EP_TX_N9	BY2	1.4 V PCML	Receive bus
B59	PCIE_EP_TX_N10	CD2	1.4 V PCML	Receive bus
B63	PCIE_EP_TX_N11	CH2	1.4 V PCML	Receive bus
B67	PCIE_EP_TX_N12	CM2	1.4 V PCML	Receive bus
B71	PCIE_EP_TX_N13	CR5	1.4 V PCML	Receive bus
B75	PCIE_EP_TX_N14	CT2	1.4 V PCML	Receive bus
B79	PCIE_EP_TX_N5	CW5	1.4 V PCML	Receive bus
B14	PCIE_EP_TX_P0	AF4	1.4 V PCML	Receive bus
B19	PCIE_EP_TX_P1	AJ1	1.4 V PCML	Receive bus
B23	PCIE_EP_TX_P2	AN1	1.4 V PCML	Receive bus
B27	PCIE_EP_TX_P3	AU1	1.4 V PCML	Receive bus
B33	PCIE_EP_TX_P4	BA1	1.4 V PCML	Receive bus
B37	PCIE_EP_TX_P5	BE1	1.4 V PCML	Receive bus
B41	PCIE_EP_TX_P6	BJ1	1.4 V PCML	Receive bus
B45	PCIE_EP_TX_P7	BN1	1.4 V PCML	Receive bus
B50	PCIE_EP_TX_P8	BU1	1.4 V PCML	Receive bus
B54	PCIE_EP_TX_P9	CA1	1.4 V PCML	Receive bus
B58	PCIE_EP_TX_P10	CE1	1.4 V PCML	Receive bus
B62	PCIE_EP_TX_P11	CJ1	1.4 V PCML	Receive bus
B66	PCIE_EP_TX_P12	CN1	1.4 V PCML	Receive bus
B70	PCIE_EP_TX_P13	CP4	1.4 V PCML	Receive bus
B74	PCIE_EP_TX_P14	CU1	1.4 V PCML	Receive bus
B78	PCIE_EP_TX_P15	CV4	1.4 V PCML	Receive bus
A17	PCIE_EP_RX_N0	AL5	1.4 V PCML	Transmit bus
A22	PCIE_EP_RX_N1	AM8	1.4 V PCML	Transmit bus
A26	PCIE_EP_RX_N2	AR5	1.4 V PCML	Transmit bus
A30	PCIE_EP_RX_N3	AT8	1.4 V PCML	Transmit bus
A36	PCIE_EP_RX_N4	AW5	1.4 V PCML	Transmit bus
				<i>continued...</i>

Edge Finger pin Number	Schematic Signal Name	FPGA Pin Number	I/O Standard	Description
A40	PCIE_EP_RX_N5	AY8	1.4 V PCML	Transmit bus
A44	PCIE_EP_RX_N6	BC5	1.4 V PCML	Transmit bus
A48	PCIE_EP_RX_N7	BG5	1.4 V PCML	Transmit bus
A53	PCIE_EP_RX_N8	BL5	1.4 V PCML	Transmit bus
A57	PCIE_EP_RX_N9	BR5	1.4 V PCML	Transmit bus
A61	PCIE_EP_RX_N10	BW5	1.4 V PCML	Transmit bus
A65	PCIE_EP_RX_N11	CC5	1.4 V PCML	Transmit bus
A69	PCIE_EP_RX_N12	CG5	1.4 V PCML	Transmit bus
A73	PCIE_EP_RX_N13	CL5	1.4 V PCML	Transmit bus
A77	PCIE_EP_RX_N14	CM8	1.4 V PCML	Transmit bus
A81	PCIE_EP_RX_N15	CT8	1.4 V PCML	Transmit bus
A16	PCIE_EP_RX_P0	AK4	1.4 V PCML	Transmit bus
A21	PCIE_EP_RX_P1	AN7	1.4 V PCML	Transmit bus
A25	PCIE_EP_RX_P2	AP4	1.4 V PCML	Transmit bus
A29	PCIE_EP_RX_P3	AU7	1.4 V PCML	Transmit bus
A35	PCIE_EP_RX_P4	AV4	1.4 V PCML	Transmit bus
A39	PCIE_EP_RX_P5	BA7	1.4 V PCML	Transmit bus
A43	PCIE_EP_RX_P6	BB4	1.4 V PCML	Transmit bus
A47	PCIE_EP_RX_P7	BF4	1.4 V PCML	Transmit bus
A52	PCIE_EP_RX_P8	BK4	1.4 V PCML	Transmit bus
A56	PCIE_EP_RX_P9	BP4	1.4 V PCML	Transmit bus
A60	PCIE_EP_RX_P10	BV4	1.4 V PCML	Transmit bus
A64	PCIE_EP_RX_p11	CB4	1.4 V PCML	Transmit bus
A68	PCIE_EP_RX_P12	CF4	1.4 V PCML	Transmit bus
A72	PCIE_EP_RX_P13	CK4	1.4 V PCML	Transmit bus
A76	PCIE_EP_RX_P14	CN7	1.4 V PCML	Transmit bus
A80	PCIE_EP_RX_P15	CU7	1.4 V PCML	Transmit bus
B11	PCIE_3V3_EP_WAKE	—	3.3V	Wake Signal
B12	PCIE_3V3_EP_CLKREQn	—	3.3V	Clock Request

### A.5.2. QSFP-DD Interface

The Intel Agilex FPGA (two F-tiles) development board includes a connector and cages system for mounting a Double Density Quad Small Form-Factor Pluggable (QSFP-DD) module. The interface connects to eight 56 Gbps PAM4 capable F-tile lanes of the Intel Agilex FPGA, supporting QSFP-DD modules, with capability of 400 Gbps aggregate bandwidth with power classifications up to 10 W.

**Table 30. QSFP-DD Pin Assignments**

Schematic Signal Name	FPGA Pin Number	I/O Standard	Description
QSFDD_TX0_P	AV52	True Differential Signaling	QSFDD Transmit Channel 0 Positive
QSFDD_TX0_N	AU51	True Differential Signaling	QSFDD Transmit Channel 0 negative
QSFDD_TX1_P	R49	True Differential Signaling	QSFDD Transmit Channel 1 Positive
QSFDD_TX1_N	T48	True Differential Signaling	QSFDD Transmit Channel 1 negative
QSFDD_TX2_P	AN51	True Differential Signaling	QSFDD Transmit Channel 2 Positive
QSFDD_TX2_N	AP52	True Differential Signaling	QSFDD Transmit Channel 2 negative
QSFDD_TX3_P	U51	True Differential Signaling	QSFDD Transmit Channel 3 Positive
QSFDD_TX3_N	V52	True Differential Signaling	QSFDD Transmit Channel 3 negative
QSFDD_TX4_P	AF52	True Differential Signaling	QSFDD Transmit Channel 4 Positive
QSFDD_TX4_N	AE51	True Differential Signaling	QSFDD Transmit Channel 4 negative
QSFDD_TX5_P	Y48	True Differential Signaling	QSFDD Transmit Channel 5 Positive
QSFDD_TX5_N	W49	True Differential Signaling	QSFDD Transmit Channel 5 negative
QSFDD_TX6_P	AJ51	True Differential Signaling	QSFDD Transmit Channel 6 Positive
QSFDD_TX6_N	AK52	True Differential Signaling	QSFDD Transmit Channel 6 negative
QSFDD_TX7_P	AA51	True Differential Signaling	QSFDD Transmit Channel 7 Positive
QSFDD_TX7_N	AB52	True Differential Signaling	QSFDD Transmit Channel 7 negative
QSFDD_RX0_P	AR55	True Differential Signaling	QSFDD Receive Channel 0 Positive
QSFDD_RX0_N	AT54	True Differential Signaling	QSFDD Receive Channel 0 negative
QSFDD_RX1_P	K52	True Differential Signaling	QSFDD Receive Channel 1 Positive
QSFDD_RX1_N	J51	True Differential Signaling	QSFDD Receive Channel 1 negative
QSFDD_RX2_P	AL55	True Differential Signaling	QSFDD Receive Channel 2 Positive
QSFDD_RX2_N	AM54	True Differential Signaling	QSFDD Receive Channel 2 negative
QSFDD_RX3_P	P52	True Differential Signaling	QSFDD Receive Channel 3 Positive
QSFDD_RX3_N	N51	True Differential Signaling	QSFDD Receive Channel 3 negative
QSFDD_RX4_P	AC55	True Differential Signaling	QSFDD Receive Channel 4 Positive
QSFDD_RX4_N	AD54	True Differential Signaling	QSFDD Receive Channel 4 negative
QSFDD_RX5_P	R55	True Differential Signaling	QSFDD Receive Channel 5 Positive
QSFDD_RX5_N	T54	True Differential Signaling	QSFDD Receive Channel 5 negative
QSFDD_RX6_P	AG55	True Differential Signaling	QSFDD Receive Channel 6 Positive
QSFDD_RX6_N	AH54	True Differential Signaling	QSFDD Receive Channel 6 negative
QSFDD_RX7_P	W55	True Differential Signaling	QSFDD Receive Channel 7 Positive
QSFDD_RX7_N	Y54	True Differential Signaling	QSFDD Receive Channel 7 negative
QSFDD_REFCLK_P	AD48	LVPECL	QSFDD Reference Clock Positive

*continued...*

Schematic Signal Name	FPGA Pin Number	I/O Standard	Description
QSFPPDD_REFCLK_N	AC49	LVPECL	QSFPPDD Reference Clock Negative
QSFPPDD_LED1 (Yellow LED)	G49	1.2V HS LVCMOS	QSFPPDD Yellow LED
QSFPPDD_LED2 (Green LED)	F48	1.2V HS LVCMOS	QSFPPDD Green LED

**Note:** For more information about Intel's True Differential Signaling technology, refer to the *Intel Agilex Device Data Sheet*.

### A.5.3. QSFP Interface

The Intel Agilex FPGA (two F-tiles) development board includes a connector and cages system for mounting a Quad Small Form-Factor Pluggable (QSFP) module. The interface connects to four 56 Gbps PAM4 capable F-tile lanes of the Intel Agilex FPGA, supporting QSFP modules, with capability of 200 Gbps aggregate bandwidth with power classifications up to 3.5 W.

**Table 31. QSFP Pin Assignments**

For more information about Intel's True Differential Signaling technology, refer to the *Intel Agilex Device Data Sheet*.

Schematic Signal Name	FPGA Pin Number	I/O Standard	Description
QSFP_TX0_P	BL49	True Differential Signaling	QSFP Transmit Channel 0 Positive
QSFP_TX0_N	BM48	True Differential Signaling	QSFP Transmit Channel 0 negative
QSFP_TX1_P	BB52	True Differential Signaling	QSFP Transmit Channel 1 Positive
QSFP_TX1_N	BA51	True Differential Signaling	QSFP Transmit Channel 1 negative
QSFP_TX2_P	BJ51	True Differential Signaling	QSFP Transmit Channel 2 Positive
QSFP_TX2_N	BK52	True Differential Signaling	QSFP Transmit Channel 2 negative
QSFP_TX3_P	BE51	True Differential Signaling	QSFP Transmit Channel 3 Positive
QSFP_TX3_N	BF52	True Differential Signaling	QSFP Transmit Channel 3 negative
QSFP_RX0_P	BL55	True Differential Signaling	QSFP Receive Channel 0 Positive
QSFP_RX0_N	BM54	True Differential Signaling	QSFP Receive Channel 0 negative
QSFP_RX1_P	AW55	True Differential Signaling	QSFP Receive Channel 1 Positive
QSFP_RX1_N	AY54	True Differential Signaling	QSFP Receive Channel 1 negative
QSFP_RX2_P	BH54	True Differential Signaling	QSFP Receive Channel 2 Positive
QSFP_RX2_N	BG55	True Differential Signaling	QSFP Receive Channel 2 negative
QSFP_RX3_P	BC55	True Differential Signaling	QSFP Receive Channel 3 Positive
QSFP_RX3_N	BD54	True Differential Signaling	QSFP Receive Channel 3 negative
QSFP_REFCLK_P	AW49	156.25 MHz LVPECL	QSFP Reference Clock Positive
QSFP_REFCLK_N	AV48	156.25 MHz LVPECL	QSFP Reference Clock Negative
QSFP_LED1 (Yellow LED)	B48	1.2 V HS LVCMOS	QSFPPDD Yellow LED
QSFP_LED2 (Green LED)	A47	1.2 V HS LVCMOS	QSFPPDD Green LED

### A.5.4. CXL Interface

The Intel Agilex FPGA (two F-tiles) development board provides a CXL connector interface for cabling to an Intel-designed M.2 SSD daughter card supporting M-Keying. This interface connects to four 28 Gbps F-tile lanes of the Intel Agilex FPGA. When connecting the development board to this SSD daughter card, the development board connects four transceiver channels from the F-tile bank 12C to M2 channels 8-11 (**J5**) of the M.2 daughter card.

**Table 32. CXL Pin Assignments**

Schematic Signal Name	FPGA Pin Number	I/O Standard	Description
CXL_TX_P0	BW49	True Differential Signaling	CXL Transmit Channel 0 Positive
CXL_TX_N0	BY48	True Differential Signaling	CXL Transmit Channel 0 Negative
CXL_TX_P1	BV52	True Differential Signaling	CXL Transmit Channel 1 Positive
CXL_TX_N1	BU51	True Differential Signaling	CXL Transmit Channel 1 Negative
CXL_TX_P2	BR49	True Differential Signaling	CXL Transmit Channel 2 Positive
CXL_TX_N2	BT48	True Differential Signaling	CXL Transmit Channel 2 Negative
CXL_TX_P3	BP52	True Differential Signaling	CXL Transmit Channel 3 Positive
CXL_TX_N3	BN51	True Differential Signaling	CXL Transmit Channel 3 Negative
CXL_RX_P0	CC55	True Differential Signaling	CXL Receive Channel 0 Positive
CXL_RX_N0	CD54	True Differential Signaling	CXL Receive Channel 0 Negative
CXL_RX_P1	CB52	True Differential Signaling	CXL Receive Channel 1 Positive
CXL_RX_N1	CA51	True Differential Signaling	CXL Receive Channel 1 Negative
CXL_RX_P2	BW55	True Differential Signaling	CXL Receive Channel 2 Positive
CXL_RX_N2	BY54	True Differential Signaling	CXL Receive Channel 2 Negative
CXL_RX_P3	BR55	True Differential Signaling	CXL Receive Channel 3 Positive
CXL_RX_N3	BT54	True Differential Signaling	CXL Receive Channel 3 Negative
REFCLK_CXL_EP_P	BC49	100 MHz LVPECL	CXL Reference Clock Positive, Local board clock
REFCLK_CXL_EP_N	BE49	100 MHz LVPECL	CXL Reference Clock Negative, Local board clock
REFCLK_CXL_CONN_P	BG49	100 MHz LVPECL	CXL Reference Clock Positive, Remote board clock
REFCLK_CLK_CONN_N	BF48	100 MHz LVPECL	CXL Reference Clock

*continued...*

Schematic Signal Name	FPGA Pin Number	I/O Standard	Description
			Negative, Remote board clock
CXL_PERSTN	D43	1.2 V HS LVCMOS	CXL Reset
CXL_PRSENTx4_N	F50	1.2 V HS LVCMOS	CXL Present

### A.5.5. DDR4 DIMM1 Interface

The Intel Agilex FPGA (two F-tiles) development board provides two DDR4 x72 DIMM interfaces connected to the FPGA fabric. DIMM1 is connected to the Intel Agilex I/O96 of banks 2C and 2D. Only one DIMM memory module is included with the development kit for evaluation of the DDR4 interfaces.

**Table 33. DIMM1 Pin Assignments**

Schematic Signal Name	FPGA Pin Number	I/O Standard	Description
DDR4_DIMM1_DQ0	DC31	1.2 V HS LVCMOS	DDR4 DIMM1 DQ0 data
DDR4_DIMM1_DQ1	DD30	1.2 V HS LVCMOS	DDR4 DIMM1 DQ1 data
DDR4_DIMM1_DQ2	CY30	1.2 V HS LVCMOS	DDR4 DIMM1 DQ2 data
DDR4_DIMM1_DQ3	DA31	1.2 V HS LVCMOS	DDR4 DIMM1 DQ3 data
DDR4_DIMM1_DQ4	DA27	1.2 V HS LVCMOS	DDR4 DIMM1 DQ4 data
DDR4_DIMM1_DQ5	CY26	1.2 V HS LVCMOS	DDR4 DIMM1 DQ5 data
DDR4_DIMM1_DQ6	DC27	1.2 V HS LVCMOS	DDR4 DIMM1 DQ6 data
DDR4_DIMM1_DQ7	DD26	1.2 V HS LVCMOS	DDR4 DIMM1 DQ7 data
DDR4_DIMM1_DQS_P0	DD28	1.2 V HS LVCMOS	DDR4 DIMM1 Data Strobe
			Positive for byte lane 0
DDR4_DIMM1_DQS_N0	DC29	1.2 V HS LVCMOS	DDR4 DIMM1 Data Strobe
			Negative for byte lane 0
DDR4_DIMM1_DBI_N0	CY28	1.2 V HS LVCMOS	DDR4 DIMM1 Data Bus Inversion for byte lane 0
DDR4_DIMM1_TDQS_N9	DA29	1.2 V HS LVCMOS	DDR4 DIMM1 Termination Data Strobe for byte lane 0
DDR4_DIMM1_DQ8	DF20	1.2 V HS LVCMOS	DDR4 DIMM1 DQ8 data
DDR4_DIMM1_DQ9	DJ21	1.2 V HS LVCMOS	DDR4 DIMM1 DQ9 data
DDR4_DIMM1_DQ10	DH20	1.2 V HS LVCMOS	DDR4 DIMM1 DQ10 data
DDR4_DIMM1_DQ11	DE21	1.2 V HS LVCMOS	DDR4 DIMM1 DQ11 data
DDR4_DIMM1_DQ12	DF16	1.2 V HS LVCMOS	DDR4 DIMM1 DQ12 data
DDR4_DIMM1_DQ13	DH16	1.2 V HS LVCMOS	DDR4 DIMM1 DQ13 data
DDR4_DIMM1_DQ14	DE17	1.2 V HS LVCMOS	DDR4 DIMM1 DQ14 data
DDR4_DIMM1_DQ15	DJ17	1.2 V HS LVCMOS	DDR4 DIMM1 DQ15 data
DDR4_DIMM1_DQS_P1	DH18	1.2 V HS LVCMOS	DDR4 DIMM1 Data Strobe
			Positive for byte lane 1
DDR4_DIMM1_DQS_N1	DJ19	1.2 V HS LVCMOS	DDR4 DIMM1 Data Strobe

*continued...*



Schematic Signal Name	FPGA Pin Number	I/O Standard	Description
			Negative for byte lane 1
DDR4_DIMM1_DBI_N1	DF18	1.2 V HS LVCMOS	DDR4 DIMM1 Data Bus Inversion for byte lane 1
DDR4_DIMM1_TDQS_N10	DE19	1.2 V HS LVCMOS	DDR4 DIMM1 Termination Data Strobe for byte lane 1
DDR4_DIMM1_DQ16	DF8	1.2 V HS LVCMOS	DDR4 DIMM1 DQ16 data
DDR4_DIMM1_DQ17	DH8	1.2 V HS LVCMOS	DDR4 DIMM1 DQ17 data
DDR4_DIMM1_DQ18	DE9	1.2 V HS LVCMOS	DDR4 DIMM1 DQ18 data
DDR4_DIMM1_DQ19	DJ9	1.2 V HS LVCMOS	DDR4 DIMM1 D19 data
DDR4_DIMM1_DQ20	DF2	1.2 V HS LVCMOS	DDR4 DIMM1 DQ20 data
DDR4_DIMM1_DQ21	DE3	1.2 V HS LVCMOS	DDR4 DIMM1 DQ21 data
DDR4_DIMM1_DQ22	DF4	1.2 V HS LVCMOS	DDR4 DIMM1 DQ22 data
DDR4_DIMM1_DQ23	DE5	1.2 V HS LVCMOS	DDR4 DIMM1 DQ23 data
DDR4_DIMM1_DQS_P2	DH6	1.2 V HS LVCMOS	DDR4 DIMM1 Data Strobe Positive for byte lane 2
DDR4_DIMM1_DQS_N2	DJ7	1.2 V HS LVCMOS	DDR4 DIMM1 Data Strobe Negative for byte lane 2
DDR4_DIMM1_DBI_N2	DF6	1.2 V HS LVCMOS	DDR4 DIMM1 Data Bus Inversion for byte lane 2
DDR4_DIMM1_TDQS_N11	DE7	1.2 V HS LVCMOS	DDR4 DIMM1 Termination Data Strobe for byte lane 2
DDR4_DIMM1_DQ24	DE15	1.2 V HS LVCMOS	DDR4 DIMM1 DQ24 data
DDR4_DIMM1_DQ25	DF14	1.2 V HS LVCMOS	DDR4 DIMM1 DQ25 data
DDR4_DIMM1_DQ26	DJ15	1.2 V HS LVCMOS	DDR4 DIMM1 DQ26 data
DDR4_DIMM1_DQ27	DH14	1.2 V HS LVCMOS	DDR4 DIMM1 DQ27 data
DDR4_DIMM1_DQ28	DF10	1.2 V HS LVCMOS	DDR4 DIMM1 DQ28 data
DDR4_DIMM1_DQ29	DH10	1.2 V HS LVCMOS	DDR4 DIMM1 DQ29 data
DDR4_DIMM1_DQ30	DJ11	1.2 V HS LVCMOS	DDR4 DIMM1 DQ30 data
DDR4_DIMM1_DQ31	DE11	1.2 V HS LVCMOS	DDR4 DIMM1 DQ31 data
DDR4_DIMM1_DQS_P3	DH12	1.2 V HS LVCMOS	DDR4 DIMM1 Data Strobe Positive for byte lane 3
DDR4_DIMM1_DQS_N3	DJ13	1.2 V HS LVCMOS	DDR4 DIMM1 Data Strobe Negative for byte lane 3
DDR4_DIMM1_DBI_N3	DF12	1.2 V HS LVCMOS	DDR4 DIMM1 Data Bus Inversion for byte lane 3
DDR4_DIMM1_TDQS_N12	DE13	1.2 V HS LVCMOS	DDR4 DIMM1 Termination Data Strobe for byte lane 3
DDR4_DIMM1_DQ32	DH26	1.2 V HS LVCMOS	DDR4 DIMM1 DQ32 data
DDR4_DIMM1_DQ33	DE27	1.2 V HS LVCMOS	DDR4 DIMM1 DQ33 data
DDR4_DIMM1_DQ34	DF26	1.2 V HS LVCMOS	DDR4 DIMM1 DQ34 data
DDR4_DIMM1_DQ35	DJ27	1.2 V HS LVCMOS	DDR4 DIMM1 DQ35 data
DDR4_DIMM1_DQ36	DE23	1.2 V HS LVCMOS	DDR4 DIMM1 DQ36 data
			<i>continued...</i>

Schematic Signal Name	FPGA Pin Number	I/O Standard	Description
DDR4_DIMM1_DQ37	DF22	1.2 V HS LVCMOS	DDR4 DIMM1 DQ37 data
DDR4_DIMM1_DQ38	DJ23	1.2 V HS LVCMOS	DDR4 DIMM1 DQ38 data
DDR4_DIMM1_DQ39	DH22	1.2 V HS LVCMOS	DDR4 DIMM1 DQ39 data
DDR4_DIMM1_DQS_P4	DH24	1.2 V HS LVCMOS	DDR4 DIMM1 Data Strobe
			Positive for byte lane 4
DDR4_DIMM1_DQS_N4	DJ25	1.2 V HS LVCMOS	DDR4 DIMM1 Data Strobe
			Negative for byte lane 4
DDR4_DIMM1_DBI_N4	DF24	1.2 V HS LVCMOS	DDR4 DIMM1 Data Bus Inversion for byte lane 4
DDR4_DIMM1_TDQS_N13	DE25	1.2 V HS LVCMOS	DDR4 DIMM1 Termination Data Strobe for byte lane 4
DDR4_DIMM1_DQ40	DC19	1.2 V HS LVCMOS	DDR4 DIMM1 DQ40 data
DDR4_DIMM1_DQ41	DD18	1.2 V HS LVCMOS	DDR4 DIMM1 DQ41 data
DDR4_DIMM1_DQ42	CY18	1.2 V HS LVCMOS	DDR4 DIMM1 DQ42 data
DDR4_DIMM1_DQ43	DA19	1.2 V HS LVCMOS	DDR4 DIMM1 DQ43 data
DDR4_DIMM1_DQ44	CY14	1.2 V HS LVCMOS	DDR4 DIMM1 DQ44 data
DDR4_DIMM1_DQ45	DA15	1.2 V HS LVCMOS	DDR4 DIMM1 DQ45 data
DDR4_DIMM1_DQ46	DC15	1.2 V HS LVCMOS	DDR4 DIMM1 DQ46 data
DDR4_DIMM1_DQ47	DD14	1.2 V HS LVCMOS	DDR4 DIMM1 DQ47 data
DDR4_DIMM1_DQS_P5	DD16	1.2 V HS LVCMOS	DDR4 DIMM1 Data Strobe
			Positive for byte lane 5
DDR4_DIMM1_DQS_N5	DC17	1.2 V HS LVCMOS	DDR4 DIMM1 Data Strobe
			Negative for byte lane 5
DDR4_DIMM1_DBI_N5	CY16	1.2 V HS LVCMOS	DDR4 DIMM1 Data Bus Inversion for byte lane 5
DDR4_DIMM1_TDQS_N14	DA17	1.2 V HS LVCMOS	DDR4 DIMM1 Termination Data Strobe for byte lane 5
DDR4_DIMM1_DQ48	CY24	1.2 V HS LVCMOS	DDR4 DIMM1 DQ48 data
DDR4_DIMM1_DQ49	DD24	1.2 V HS LVCMOS	DDR4 DIMM1 DQ49 data
DDR4_DIMM1_DQ50	DC25	1.2 V HS LVCMOS	DDR4 DIMM1 DQ50 data
DDR4_DIMM1_DQ51	DA25	1.2 V HS LVCMOS	DDR4 DIMM1 DQ51 data
DDR4_DIMM1_DQ52	CY20	1.2 V HS LVCMOS	DDR4 DIMM1 DQ52 data
DDR4_DIMM1_DQ53	DC21	1.2 V HS LVCMOS	DDR4 DIMM1 DQ53 data
DDR4_DIMM1_DQ54	DA21	1.2 V HS LVCMOS	DDR4 DIMM1 DQ54 data
DDR4_DIMM1_DQ55	DD20	1.2 V HS LVCMOS	DDR4 DIMM1 DQ55 data
DDR4_DIMM1_DQS_P6	DD22	1.2 V HS LVCMOS	DDR4 DIMM1 Data Strobe
			Positive for byte lane 6
DDR4_DIMM1_DQS_N6	DC23	1.2 V HS LVCMOS	DDR4 DIMM1 Data Strobe
			Negative for byte lane 6
DDR4_DIMM1_DBI_N6	CY22	1.2 V HS LVCMOS	DDR4 DIMM1 Data Bus Inversion for byte lane 6

*continued...*

Schematic Signal Name	FPGA Pin Number	I/O Standard	Description
DDR4_DIMM1_TDQS_N15	DA23	1.2 V HS LVCMOS	DDR4 DIMM1 Termination Data Strobe for byte lane 6
DDR4_DIMM1_DQ56	CY12	1.2 V HS LVCMOS	DDR4 DIMM1 DQ56 data
DDR4_DIMM1_DQ57	DC13	1.2 V HS LVCMOS	DDR4 DIMM1 DQ57 data
DDR4_DIMM1_DQ58	DA13	1.2 V HS LVCMOS	DDR4 DIMM1 DQ58 data
DDR4_DIMM1_DQ59	DD12	1.2 V HS LVCMOS	DDR4 DIMM1 DQ59 data
DDR4_DIMM1_DQ60	DC9	1.2 V HS LVCMOS	DDR4 DIMM1 DQ60 data
DDR4_DIMM1_DQ61	DA9	1.2 V HS LVCMOS	DDR4 DIMM1 DQ61 data
DDR4_DIMM1_DQ62	CY8	1.2 V HS LVCMOS	DDR4 DIMM1 DQ62 data
DDR4_DIMM1_DQ63	DD8	1.2 V HS LVCMOS	DDR4 DIMM1 DQ63 data
DDR4_DIMM1_DQS_P7	DD10	1.2 V HS LVCMOS	DDR4 DIMM1 Data Strobe Positive for byte lane 7
DDR4_DIMM1_DQS_N7	DC11	1.2 V HS LVCMOS	DDR4 DIMM1 Data Strobe Negative for byte lane 7
DDR4_DIMM1_DBI_N7	CY10	1.2 V HS LVCMOS	DDR4 DIMM1 Data Bus Inversion for byte lane 7
DDR4_DIMM1_TDQS_N16	DA11	1.2 V HS LVCMOS	DDR4 DIMM1 Termination Data Strobe for byte lane 7
DDR4_DIMM1_DQ64	CW23	1.2 V HS LVCMOS	DDR4 DIMM1 DQ64 data
DDR4_DIMM1_DQ65	CV22	1.2 V HS LVCMOS	DDR4 DIMM1 DQ65 data
DDR4_DIMM1_DQ66	CT22	1.2 V HS LVCMOS	DDR4 DIMM1 DQ66 data
DDR4_DIMM1_DQ67	CR23	1.2 V HS LVCMOS	DDR4 DIMM1 DQ67 data
DDR4_DIMM1_DQ68	CR19	1.2 V HS LVCMOS	DDR4 DIMM1 DQ68 data
DDR4_DIMM1_DQ69	CV18	1.2 V HS LVCMOS	DDR4 DIMM1 DQ69 data
DDR4_DIMM1_DQ70	CW19	1.2 V HS LVCMOS	DDR4 DIMM1 DQ70 data
DDR4_DIMM1_DQ71	CT18	1.2 V HS LVCMOS	DDR4 DIMM1 DQ71 data
DDR4_DIMM1_DQS_P8	CV20	1.2 V HS LVCMOS	DDR4 DIMM1 Data Strobe Positive for byte lane 8
DDR4_DIMM1_DQS_N8	CW21	1.2 V HS LVCMOS	DDR4 DIMM1 Data Strobe Negative for byte lane 8
DDR4_DIMM1_DBI_N8	CT20	1.2 V HS LVCMOS	DDR4 DIMM1 Data Bus Inversion for byte lane 8
DDR4_DIMM1_TDQS_N17	CR21	1.2 V HS LVCMOS	DDR4 DIMM1 Termination Data Strobe for byte lane 8
DDR4_DIMM1_C1	CN29	1.2 V HS LVCMOS	DDR4 DIMM1 Stacked Device Chip ID 1
DDR4_DIMM1_C0	CP28	1.2 V HS LVCMOS	DDR4 DIMM1 Stacked Device Chip ID 0
DDR4_DIMM1_BG0	CR25	1.2 V HS LVCMOS	DDR4 DIMM1 Bank Group 0
DDR4_DIMM1_BA1	CT24	1.2 V HS LVCMOS	DDR4 DIMM1 Bank Address 1
DDR4_DIMM1_BA0	CW25	1.2 V HS LVCMOS	DDR4 DIMM1 Bank Address 0
DDR4_DIMM1_A17	CV24	1.2 V HS LVCMOS	DDR4 DIMM1 Address 17
DDR4_DIMM1_A16	CR27	1.2 V HS LVCMOS	DDR4 DIMM1 Address 16

*continued...*

Schematic Signal Name	FPGA Pin Number	I/O Standard	Description
DDR4_DIMM1_A15	CT26	1.2 V HS LVCMOS	DDR4 DIMM1 Address 15
DDR4_DIMM1_A14	CW27	1.2 V HS LVCMOS	DDR4 DIMM1 Address 14
DDR4_DIMM1_A13	CV26	1.2 V HS LVCMOS	DDR4 DIMM1 Address 13
DDR4_DIMM1_A12	CR29	1.2 V HS LVCMOS	DDR4 DIMM1 Address 12
DDR4_DIMM1_A11	CR31	1.2 V HS LVCMOS	DDR4 DIMM1 Address 11
DDR4_DIMM1_A10	CT30	1.2 V HS LVCMOS	DDR4 DIMM1 Address 10
DDR4_DIMM1_A9	CW31	1.2 V HS LVCMOS	DDR4 DIMM1 Address 9
DDR4_DIMM1_A8	CV30	1.2 V HS LVCMOS	DDR4 DIMM1 Address 8
DDR4_DIMM1_A7	CR33	1.2 V HS LVCMOS	DDR4 DIMM1 Address 7
DDR4_DIMM1_A6	CT32	1.2 V HS LVCMOS	DDR4 DIMM1 Address 6
DDR4_DIMM1_A5	CW33	1.2 V HS LVCMOS	DDR4 DIMM1 Address 5
DDR4_DIMM1_A4	CV32	1.2 V HS LVCMOS	DDR4 DIMM1 Address 4
DDR4_DIMM1_A3	CR35	1.2 V HS LVCMOS	DDR4 DIMM1 Address 3
DDR4_DIMM1_A2	CT34	1.2 V HS LVCMOS	DDR4 DIMM1 Address 2
DDR4_DIMM1_A1	CW35	1.2 V HS LVCMOS	DDR4 DIMM1 Address 1
DDR4_DIMM1_A0	CV34	1.2 V HS LVCMOS	DDR4 DIMM1 Address 0
DDR4_DIMM1_PAR	CL31	1.2 V HS LVCMOS	DDR4 DIMM1 Parity
DDR4_DIMM1_CS_N1	CK30	1.2 V HS LVCMOS	DDR4 DIMM1 Chip Select 1
DDR4_DIMM1_CK_N0	CN31	1.2 V HS LVCMOS	DDR4 DIMM1 Clock 0, Positive
DDR4_DIMM1_CK_P0	CP30	1.2 V HS LVCMOS	DDR4 DIMM1 Clock 0, Negative
DDR4_DIMM1_CKE1	CL33	1.2 V HS LVCMOS	DDR4 DIMM1 Clock Enable 1
DDR4_DIMM1_CKE0	CK32	1.2 V HS LVCMOS	DDR4 DIMM1 Clock Enable 0
DDR4_DIMM1_ODT1	CN33	1.2 V HS LVCMOS	DDR4 DIMM1 On Die Termination 1
DDR4_DIMM1_ODT0	CP32	1.2 V HS LVCMOS	DDR4 DIMM1 On Die Termination 0
DDR4_DIMM1_ACT_N	CL35	1.2 V HS LVCMOS	DDR4 DIMM1 Activate Command
DDR4_DIMM1_CS_N0	CK34	1.2 V HS LVCMOS	DDR4 DIMM1 Chip Select 0
DDR4_DIMM1_RESET_N	CN35	1.2 V HS LVCMOS	DDR4 DIMM1 Reset
DDR4_DIMM1_BG1	CP34	1.2 V HS LVCMOS	DDR4 DIMM1 Bank Group 1

### A.5.6. DDR4 DIMM2 Interface

The Intel Agilex FPGA (two F-tiles) development board provides two DDR4 x72 DIMM interfaces connected to the FPGA fabric. DIMM2 is connected to the Intel Agilex I/O96 of banks 2E and 2F. Only one DIMM memory module is included with the development kit for evaluation of the DIMM interfaces.

**Table 34. DIMM2 Pin Assignments**

Schematic Signal Name	FPGA Pin Number	I/O Standard	Description
DDR4_DIMM2_DQ0	CK46	1.2 V HS LVCMOS	DDR4 DIMM2 DQ0 data
DDR4_DIMM2_DQ1	CL47	1.2 V HS LVCMOS	DDR4 DIMM2 DQ1 data
DDR4_DIMM2_DQ2	CN47	1.2 V HS LVCMOS	DDR4 DIMM2 DQ2 data
DDR4_DIMM2_DQ3	CP46	1.2 V HS LVCMOS	DDR4 DIMM2 DQ3 data
DDR4_DIMM2_DQ4	CL43	1.2 V HS LVCMOS	DDR4 DIMM2 DQ4 data
DDR4_DIMM2_DQ5	CK42	1.2 V HS LVCMOS	DDR4 DIMM2 DQ5 data
DDR4_DIMM2_DQ6	CN43	1.2 V HS LVCMOS	DDR4 DIMM2 DQ6 data
DDR4_DIMM2_DQ7	CP42	1.2 V HS LVCMOS	DDR4 DIMM2 DQ7 data
DDR4_DIMM2_DQS_P0	CP44	1.2 V HS LVCMOS	DDR4 DIMM2 Data Strobe Positive for byte lane 0
DDR4_DIMM2_DQS_N0	CN45	1.2 V HS LVCMOS	DDR4 DIMM2 Data Strobe Negative for byte lane 0
DDR4_DIMM2_DBI_N0	CK44	1.2 V HS LVCMOS	DDR4 DIMM2 Data Bus Inversion for byte lane 0
DDR4_DIMM2_TDQS_N9	CL45	1.2 V HS LVCMOS	DDR4 DIMM2 Termination Data Strobe for byte lane 0
DDR4_DIMM2_DQ8	DA45	1.2 V HS LVCMOS	DDR4 DIMM2 DQ8 data
DDR4_DIMM2_DQ9	DC45	1.2 V HS LVCMOS	DDR4 DIMM2 DQ9 data
DDR4_DIMM2_DQ10	DD44	1.2 V HS LVCMOS	DDR4 DIMM2 DQ10 data
DDR4_DIMM2_DQ11	CY44	1.2 V HS LVCMOS	DDR4 DIMM2 DQ11 data
DDR4_DIMM2_DQ12	DA49	1.2 V HS LVCMOS	DDR4 DIMM2 DQ12 data
DDR4_DIMM2_DQ13	CY48	1.2 V HS LVCMOS	DDR4 DIMM2 DQ13 data
DDR4_DIMM2_DQ14	DD48	1.2 V HS LVCMOS	DDR4 DIMM2 DQ14 data
DDR4_DIMM2_DQ15	DC49	1.2 V HS LVCMOS	DDR4 DIMM2 DQ15 data
DDR4_DIMM2_DQS_P1	DD46	1.2 V HS LVCMOS	DDR4 DIMM2 Data Strobe Positive for byte lane 1
DDR4_DIMM2_DQS_N1	DC47	1.2 V HS LVCMOS	DDR4 DIMM2 Data Strobe Negative for byte lane 1
DDR4_DIMM2_DBI_N1	CY46	1.2 V HS LVCMOS	DDR4 DIMM2 Data Bus Inversion for byte lane 1
DDR4_DIMM2_TDQS_N10	DA47	1.2 V HS LVCMOS	DDR4 DIMM2 Termination Data Strobe for byte lane 1
DDR4_DIMM2_DQ16	CN49	1.2 V HS LVCMOS	DDR4 DIMM2 DQ16 data
DDR4_DIMM2_DQ17	CP48	1.2 V HS LVCMOS	DDR4 DIMM2 DQ17 data
DDR4_DIMM2_DQ18	CL49	1.2 V HS LVCMOS	DDR4 DIMM2 DQ18 data
DDR4_DIMM2_DQ19	CK48	1.2 V HS LVCMOS	DDR4 DIMM2 DQ19 data
DDR4_DIMM2_DQ20	CM52	1.2 V HS LVCMOS	DDR4 DIMM2 DQ20 data
DDR4_DIMM2_DQ21	CT52	1.2 V HS LVCMOS	DDR4 DIMM2 DQ21 data
DDR4_DIMM2_DQ22	CN53	1.2 V HS LVCMOS	DDR4 DIMM2 DQ22 data

*continued...*

Schematic Signal Name	FPGA Pin Number	I/O Standard	Description
DDR4_DIMM2_DQ23	CR53	1.2 V HS LVCMOS	DDR4 DIMM2 DQ23 data
DDR4_DIMM2_DQS_P2	CP50	1.2 V HS LVCMOS	DDR4 DIMM2 Data Strobe
			Positive for byte lane 2
DDR4_DIMM2_DQS_N2	CN51	1.2 V HS LVCMOS	DDR4 DIMM2 Data Strobe
			Negative for byte lane 2
DDR4_DIMM2_DBI_N2	CK50	1.2 V HS LVCMOS	DDR4 DIMM2 Data Bus Inversion for byte lane 2
DDR4_DIMM2_TDQS_N11	CL51	1.2 V HS LVCMOS	DDR4 DIMM2 Termination Data Strobe for byte lane 2
DDR4_DIMM2_DQ24	CR47	1.2 V HS LVCMOS	DDR4 DIMM2 DQ24 data
DDR4_DIMM2_DQ25	CT46	1.2 V HS LVCMOS	DDR4 DIMM2 DQ25 data
DDR4_DIMM2_DQ26	CV46	1.2 V HS LVCMOS	DDR4 DIMM2 DQ26 data
DDR4_DIMM2_DQ27	CW47	1.2 V HS LVCMOS	DDR4 DIMM2 DQ27 data
DDR4_DIMM2_DQ28	CW43	1.2 V HS LVCMOS	DDR4 DIMM2 DQ28 data
DDR4_DIMM2_DQ29	CV42	1.2 V HS LVCMOS	DDR4 DIMM2 DQ29 data
DDR4_DIMM2_DQ30	CR43	1.2 V HS LVCMOS	DDR4 DIMM2 DQ30 data
DDR4_DIMM2_DQ31	CT42	1.2 V HS LVCMOS	DDR4 DIMM2 DQ31 data
DDR4_DIMM2_DQS_P3	CV44	1.2 V HS LVCMOS	DDR4 DIMM2 Data Strobe
			Positive for byte lane 3
DDR4_DIMM2_DQS_N3	CW45	1.2 V HS LVCMOS	DDR4 DIMM2 Data Strobe
			Negative for byte lane 3
DDR4_DIMM2_DBI_N3	CT44	1.2 V HS LVCMOS	DDR4 DIMM2 Data Bus Inversion for byte lane 3
DDR4_DIMM2_TDQS_N12	CR45	1.2 V HS LVCMOS	DDR4 DIMM2 Termination Data Strobe for byte lane 3
DDR4_DIMM2_DQ32	CV48	1.2 V HS LVCMOS	DDR4 DIMM2 DQ32 data
DDR4_DIMM2_DQ33	CT48	1.2 V HS LVCMOS	DDR4 DIMM2 DQ33 data
DDR4_DIMM2_DQ34	CW49	1.2 V HS LVCMOS	DDR4 DIMM2 DQ34 data
DDR4_DIMM2_DQ35	CR49	1.2 V HS LVCMOS	DDR4 DIMM2 DQ35 data
DDR4_DIMM2_DQ36	CW53	1.2 V HS LVCMOS	DDR4 DIMM2 DQ36 data
DDR4_DIMM2_DQ37	CV52	1.2 V HS LVCMOS	DDR4 DIMM2 DQ37 data
DDR4_DIMM2_DQ38	CW55	1.2 V HS LVCMOS	DDR4 DIMM2 DQ38 data
DDR4_DIMM2_DQ39	CV54	1.2 V HS LVCMOS	DDR4 DIMM2 DQ39 data
DDR4_DIMM2_DQS_P4	CV50	1.2 V HS LVCMOS	DDR4 DIMM2 Data Strobe
			Positive for byte lane 4
DDR4_DIMM2_DQS_N4	CW51	1.2 V HS LVCMOS	DDR4 DIMM2 Data Strobe
			Negative for byte lane 4
DDR4_DIMM2_DBI_N4	CT50	1.2 V HS LVCMOS	DDR4 DIMM2 Data Bus Inversion for byte lane 4
DDR4_DIMM2_TDQS_N13	CR51	1.2 V HS LVCMOS	DDR4 DIMM2 Termination Data Strobe for byte lane 4
DDR4_DIMM2_DQ40	CY50	1.2 V HS LVCMOS	DDR4 DIMM2 DQ40 data
			<i>continued...</i>

Schematic Signal Name	FPGA Pin Number	I/O Standard	Description
DDR4_DIMM2_DQ41	DC51	1.2 V HS LVCMOS	DDR4 DIMM2 DQ41 data
DDR4_DIMM2_DQ42	DA51	1.2 V HS LVCMOS	DDR4 DIMM2 DQ42 data
DDR4_DIMM2_DQ43	DD50	1.2 V HS LVCMOS	DDR4 DIMM2 DQ43 data
DDR4_DIMM2_DQ44	CY54	1.2 V HS LVCMOS	DDR4 DIMM2 DQ44 data
DDR4_DIMM2_DQ45	DA55	1.2 V HS LVCMOS	DDR4 DIMM2 DQ45 data
DDR4_DIMM2_DQ46	DD54	1.2 V HS LVCMOS	DDR4 DIMM2 DQ46 data
DDR4_DIMM2_DQ47	DC55	1.2 V HS LVCMOS	DDR4 DIMM2 DQ47 data
DDR4_DIMM2_DQS_P5	DD52	1.2 V HS LVCMOS	DDR4 DIMM2 Data Strobe
			Positive for byte lane 5
DDR4_DIMM2_DQS_N5	DC52	1.2 V HS LVCMOS	DDR4 DIMM2 Data Strobe
			Negative for byte lane 5
DDR4_DIMM2_DBI_N5	CY52	1.2 V HS LVCMOS	DDR4 DIMM2 Data Bus Inversion for byte lane 5
DDR4_DIMM2_TDQS_N14	DA53	1.2 V HS LVCMOS	DDR4 DIMM2 Termination Data Strobe for byte lane 5
DDR4_DIMM2_DQ48	CL41	1.2 V HS LVCMOS	DDR4 DIMM2 DQ48 data
DDR4_DIMM2_DQ49	CN41	1.2 V HS LVCMOS	DDR4 DIMM2 DQ49 data
DDR4_DIMM2_DQ50	CK40	1.2 V HS LVCMOS	DDR4 DIMM2 DQ50 data
DDR4_DIMM2_DQ51	CP40	1.2 V HS LVCMOS	DDR4 DIMM2 DQ51 data
DDR4_DIMM2_DQ52	CK36	1.2 V HS LVCMOS	DDR4 DIMM2 DQ52 data
DDR4_DIMM2_DQ53	CN37	1.2 V HS LVCMOS	DDR4 DIMM2 DQ53 data
DDR4_DIMM2_DQ54	CL37	1.2 V HS LVCMOS	DDR4 DIMM2 DQ54 data
DDR4_DIMM2_DQ55	CP36	1.2 V HS LVCMOS	DDR4 DIMM2 DQ55 data
DDR4_DIMM2_DQS_P6	CP38	1.2 V HS LVCMOS	DDR4 DIMM2 Data Strobe
			Positive for byte lane 6
DDR4_DIMM2_DQS_N6	CN39	1.2 V HS LVCMOS	DDR4 DIMM2 Data Strobe
			Negative for byte lane 6
DDR4_DIMM2_DBI_N6	CK38	1.2 V HS LVCMOS	DDR4 DIMM2 Data Bus Inversion for byte lane 6
DDR4_DIMM2_TDQS_N15	CL39	1.2 V HS LVCMOS	DDR4 DIMM2 Termination Data Strobe for byte lane 6
DDR4_DIMM2_DQ56	DF46	1.2 V HS LVCMOS	DDR4 DIMM2 DQ56 data
DDR4_DIMM2_DQ57	DE47	1.2 V HS LVCMOS	DDR4 DIMM2 DQ57 data
DDR4_DIMM2_DQ58	DH46	1.2 V HS LVCMOS	DDR4 DIMM2 DQ58 data
DDR4_DIMM2_DQ59	DJ47	1.2 V HS LVCMOS	DDR4 DIMM2 DQ59 data
DDR4_DIMM2_DQ60	DE53	1.2 V HS LVCMOS	DDR4 DIMM2 DQ60 data
DDR4_DIMM2_DQ61	DF52	1.2 V HS LVCMOS	DDR4 DIMM2 DQ61 data
DDR4_DIMM2_DQ62	DG51	1.2 V HS LVCMOS	DDR4 DIMM2 DQ62 data
DDR4_DIMM2_DQ63	DH50	1.2 V HS LVCMOS	DDR4 DIMM2 DQ63 data
DDR4_DIMM2_DQS_P7	DH48	1.2 V HS LVCMOS	DDR4 DIMM2 Data Strobe

*continued...*

Schematic Signal Name	FPGA Pin Number	I/O Standard	Description
			Positive for byte lane 7
DDR4_DIMM2_DQS_N7	DJ49	1.2 V HS LVCMOS	DDR4 DIMM2 Data Strobe
			Negative for byte lane 7
DDR4_DIMM2_DBI_N7	DF48	1.2 V HS LVCMOS	DDR4 DIMM2 Data Bus Inversion for byte lane 7
DDR4_DIMM2_TDQS_N16	DE49	1.2 V HS LVCMOS	DDR4 DIMM2 Termination Data Strobe for byte lane 7
DDR4_DIMM2_DQ64	CW41	1.2 V HS LVCMOS	DDR4 DIMM2 DQ64 data
DDR4_DIMM2_DQ65	CV40	1.2 V HS LVCMOS	DDR4 DIMM2 DQ65 data
DDR4_DIMM2_DQ66	CR41	1.2 V HS LVCMOS	DDR4 DIMM2 DQ66 data
DDR4_DIMM2_DQ67	CT40	1.2 V HS LVCMOS	DDR4 DIMM2 DQ67 data
DDR4_DIMM2_DQ68	CR37	1.2 V HS LVCMOS	DDR4 DIMM2 DQ68 data
DDR4_DIMM2_DQ69	CV36	1.2 V HS LVCMOS	DDR4 DIMM2 DQ69 data
DDR4_DIMM2_DQ70	CW37	1.2 V HS LVCMOS	DDR4 DIMM2 DQ70 data
DDR4_DIMM2_DQ71	CT36	1.2 V HS LVCMOS	DDR4 DIMM2 DQ71 data
DDR4_DIMM2_DQS_P8	CV38	1.2 V HS LVCMOS	DDR4 DIMM2 Data Strobe
			Positive for byte lane 8
DDR4_DIMM2_DQS_N8	CW39	1.2 V HS LVCMOS	DDR4 DIMM2 Data Strobe
			Negative for byte lane 8
DDR4_DIMM2_DBI_N8	CT38	1.2 V HS LVCMOS	DDR4 DIMM2 Data Bus Inversion for byte lane 8
DDR4_DIMM2_TDQS_N17	CR39	1.2 V HS LVCMOS	DDR4 DIMM2 Termination Data Strobe for byte lane 8
DDR4_DIMM2_C1	DJ33	1.2 V HS LVCMOS	DDR4 DIMM2 Stacked Device Chip ID 1
DDR4_DIMM2_C0	DH32	1.2 V HS LVCMOS	DDR4 DIMM2 Stacked Device Chip ID 0
DDR4_DIMM2_BG0	DA33	1.2 V HS LVCMOS	DDR4 DIMM2 Bank Group 0
DDR4_DIMM2_BA1	CY32	1.2 V HS LVCMOS	DDR4 DIMM2 Bank Address 1
DDR4_DIMM2_BA0	DC33	1.2 V HS LVCMOS	DDR4 DIMM2 Bank Address 0
DDR4_DIMM2_A17	DD32	1.2 V HS LVCMOS	DDR4 DIMM2 Address 17
DDR4_DIMM2_A16	DA35	1.2 V HS LVCMOS	DDR4 DIMM2 Address 16
DDR4_DIMM2_A15	CY34	1.2 V HS LVCMOS	DDR4 DIMM2 Address 15
DDR4_DIMM2_A14	DC35	1.2 V HS LVCMOS	DDR4 DIMM2 Address 14
DDR4_DIMM2_A13	DD34	1.2 V HS LVCMOS	DDR4 DIMM2 Address 13
DDR4_DIMM2_A12	DA37	1.2 V HS LVCMOS	DDR4 DIMM2 Address 12
DDR4_DIMM2_A11	DE35	1.2 V HS LVCMOS	DDR4 DIMM2 Address 11
DDR4_DIMM2_A10	DF34	1.2 V HS LVCMOS	DDR4 DIMM2 Address 10
DDR4_DIMM2_A9	DJ35	1.2 V HS LVCMOS	DDR4 DIMM2 Address 9
DDR4_DIMM2_A8	DH34	1.2 V HS LVCMOS	DDR4 DIMM2 Address 8
DDR4_DIMM2_A7	DE37	1.2 V HS LVCMOS	DDR4 DIMM2 Address 7
DDR4_DIMM2_A6	DF36	1.2 V HS LVCMOS	DDR4 DIMM2 Address 6
			<i>continued...</i>



Schematic Signal Name	FPGA Pin Number	I/O Standard	Description
DDR4_DIMM2_A5	DJ37	1.2 V HS LVCMOS	DDR4 DIMM2 Address 5
DDR4_DIMM2_A4	DH36	1.2 V HS LVCMOS	DDR4 DIMM2 Address 4
DDR4_DIMM2_A3	DE39	1.2 V HS LVCMOS	DDR4 DIMM2 Address 3
DDR4_DIMM2_A2	DF38	1.2 V HS LVCMOS	DDR4 DIMM2 Address 2
DDR4_DIMM2_A1	DJ39	1.2 V HS LVCMOS	DDR4 DIMM2 Address 1
DDR4_DIMM2_A0	DH38	1.2 V HS LVCMOS	DDR4 DIMM2 Address 0
DDR4_DIMM2_PAR	DA39	1.2 V HS LVCMOS	DDR4 DIMM2 Parity
DDR4_DIMM2_CS_N1	CY38	1.2 V HS LVCMOS	DDR4 DIMM2 Chip Select 1
DDR4_DIMM2_CK_N0	DC39	1.2 V HS LVCMOS	DDR4 DIMM2 Clock 0, Positive
DDR4_DIMM2_CK_P0	DD38	1.2 V HS LVCMOS	DDR4 DIMM2 Clock 0, Negative
DDR4_DIMM2_CKE1	DA41	1.2 V HS LVCMOS	DDR4 DIMM2 Clock Enable 1
DDR4_DIMM2_CKE0	DD40	1.2 V HS LVCMOS	DDR4 DIMM2 Clock Enable 0
DDR4_DIMM2_ODT1	DC41	1.2 V HS LVCMOS	DDR4 DIMM2 On Die Termination 1
DDR4_DIMM2_ODT0	DD40	1.2 V HS LVCMOS	DDR4 DIMM2 On Die Termination 0
DDR4_DIMM2_ACT_N	DA43	1.2 V HS LVCMOS	DDR4 DIMM2 Activate Command
DDR4_DIMM2_CS_N0	CY42	1.2 V HS LVCMOS	DDR4 DIMM2 Chip Select 0
DDR4_DIMM2_RESET_N	DC43	1.2 V HS LVCMOS	DDR4 DIMM2 Reset
DDR4_DIMM2_BG1	DD42	1.2 V HS LVCMOS	DDR4 DIMM2 Bank Group 1

### A.5.7. DDR4 Component Interface

The Intel Agilex FPGA (two F-tiles) development board provides a DDR4 x40 Interface comprised of five DDR4 x8 components for HPS access. This gives 32-bits data plus 8-bits ECC, which are connected to I/O96 of bank 3D.

**Table 35. DDR4 Component Pin Assignments**

Schematic Signal Name	FPGA Pin Number	I/O Standard	Description
DDR4_COMP_DQ0	F12	1.2 V HS LVCMOS	DDR4 component DQ0 data
DDR4_COMP_DQ1	F8	1.2 V HS LVCMOS	DDR4 component DQ1 data
DDR4_COMP_DQ2	G11	1.2 V HS LVCMOS	DDR4 component DQ2 data
DDR4_COMP_DQ3	K8	1.2 V HS LVCMOS	DDR4 component DQ3 data
DDR4_COMP_DQ4	J11	1.2 V HS LVCMOS	DDR4 component DQ4 data
DDR4_COMP_DQ5	G7	1.2 V HS LVCMOS	DDR4 component DQ5 data
DDR4_COMP_DQ6	K12	1.2 V HS LVCMOS	DDR4 component DQ6 data
DDR4_COMP_DQ7	J7	1.2 V HS LVCMOS	DDR4 component DQ7 data
DDR4_COMP_DQS_P0	G9	1.2 V HS LVCMOS	DDR4 component DQS 0 strobe positive

*continued...*

Schematic Signal Name	FPGA Pin Number	I/O Standard	Description
DDR4_COMP_DQS_N0	F10	1.2 V HS LVCMOS	DDR4 component DQS 0 strobe negative
DDR4_COMP_DBI_N0	J9	1.2 V HS LVCMOS	DDR4 component Data Bus Inversion for byte lane 0
DDR4_COMP_DQ8	M6	1.2 V HS LVCMOS	DDR4 component DQ8 data
DDR4_COMP_DQ9	P2	1.2 V HS LVCMOS	DDR4 component DQ9 data
DDR4_COMP_DQ10	L5	1.2 V HS LVCMOS	DDR4 component DQ10 data
DDR4_COMP_DQ11	R1	1.2 V HS LVCMOS	DDR4 component DQ11 data
DDR4_COMP_DQ12	P6	1.2 V HS LVCMOS	DDR4 component DQ12 data
DDR4_COMP_DQ13	R5	1.2 V HS LVCMOS	DDR4 component DQ13 data
DDR4_COMP_DQ14	M2	1.2 V HS LVCMOS	DDR4 component DQ14 data
DDR4_COMP_DQ15	L1	1.2 V HS LVCMOS	DDR4 component DQ15 data
DDR4_COMP_DQS_P1	L3	1.2 V HS LVCMOS	DDR4 component DQS 1 strobe positive
DDR4_COMP_DQS_N1	M4	1.2 V HS LVCMOS	DDR4 component DQS 1 strobe negative
DDR4_COMP_DBI_N1	R3	1.2 V HS LVCMOS	DDR4 component Data Bus Inversion for byte lane 1
DDR4_COMP_DQ16	A9	1.2 V HS LVCMOS	DDR4 component DQ16 data
DDR4_COMP_DQ17	B6	1.2 V HS LVCMOS	DDR4 component DQ17 data
DDR4_COMP_DQ18	E9	1.2 V HS LVCMOS	DDR4 component DQ18 data
DDR4_COMP_DQ19	D6	1.2 V HS LVCMOS	DDR4 component DQ19 data
DDR4_COMP_DQ20	D10	1.2 V HS LVCMOS	DDR4 component DQ20 data
DDR4_COMP_DQ21	C5	1.2 V HS LVCMOS	DDR4 component DQ21 data
DDR4_COMP_DQ22	B10	1.2 V HS LVCMOS	DDR4 component DQ22 data
DDR4_COMP_DQ23	E5	1.2 V HS LVCMOS	DDR4 component DQ23 data
DDR4_COMP_DQS_P2	A7	1.2 V HS LVCMOS	DDR4 component DQS 2 strobe positive
DDR4_COMP_DQS_N2	B8	1.2 V HS LVCMOS	DDR4 component DQS 2 strobe negative
DDR4_COMP_DBI_N2	E7	1.2 V HS LVCMOS	DDR4 component Data Bus Inversion for byte lane 2
DDR4_COMP_DQ24	F6	1.2 V HS LVCMOS	DDR4 component DQ24 data
DDR4_COMP_DQ25	J1	1.2 V HS LVCMOS	DDR4 component DQ25 data
DDR4_COMP_DQ26	F2	1.2 V HS LVCMOS	DDR4 component DQ26 data
DDR4_COMP_DQ27	K2	1.2 V HS LVCMOS	DDR4 component DQ27 data
DDR4_COMP_DQ28	K6	1.2 V HS LVCMOS	DDR4 component DQ28 data
DDR4_COMP_DQ29	J5	1.2 V HS LVCMOS	DDR4 component DQ29 data
DDR4_COMP_DQ30	G5	1.2 V HS LVCMOS	DDR4 component DQ30 data
DDR4_COMP_DQ31	G1	1.2 V HS LVCMOS	DDR4 component DQ31 data
DDR4_COMP_DQS_P3	G3	1.2 V HS LVCMOS	DDR4 component DQS 3 strobe positive
DDR4_COMP_DQS_N3	F4	1.2 V HS LVCMOS	DDR4 component DQS 3 strobe negative
DDR4_COMP_DBI_N3	J3	1.2 V HS LVCMOS	DDR4 component Data Bus Inversion for byte lane 3
DDR4_COMP_DQ32	AA7	1.2 V HS LVCMOS	DDR4 component DQ32 data
<i>continued...</i>			

Schematic Signal Name	FPGA Pin Number	I/O Standard	Description
DDR4_COMP_DQ33	AD2	1.2 V HS LVCMOS	DDR4 component DQ33 data
DDR4_COMP_DQ34	AB2	1.2 V HS LVCMOS	DDR4 component DQ34 data
DDR4_COMP_DQ35	AB8	1.2 V HS LVCMOS	DDR4 component DQ35 data
DDR4_COMP_DQ36	AA1	1.2 V HS LVCMOS	DDR4 component DQ36 data
DDR4_COMP_DQ37	AE7	1.2 V HS LVCMOS	DDR4 component DQ37 data
DDR4_COMP_DQ38	AE1	1.2 V HS LVCMOS	DDR4 component DQ38 data
DDR4_COMP_DQ39	AD6	1.2 V HS LVCMOS	DDR4 component DQ39 data
DDR4_COMP_DQS_P4	AA5	1.2 V HS LVCMOS	DDR4 component DQS 4 strobe positive
DDR4_COMP_DQS_N4	AB6	1.2 V HS LVCMOS	DDR4 component DQS 4 strobe negative
DDR4_COMP_DBI_N4	AA3	1.2 V HS LVCMOS	DDR4 component Data Bus Inversion for byte lane 4
DDR4_COMP_BG0	Y2	1.2 V HS LVCMOS	DDR4 Component Bank Group 0
DDR4_COMP_BA1	W1	1.2 V HS LVCMOS	DDR4 Component Bank Address 1
DDR4_COMP_BA0	T2	1.2 V HS LVCMOS	DDR4 Component Bank Address 0
DDR4_COMP_ALERT_N	U1	1.2 V HS LVCMOS	DDR4 Component Alert
DDR4_COMP_A16	Y4	1.2 V HS LVCMOS	DDR4 Component Address 16
DDR4_COMP_A15	W3	1.2 V HS LVCMOS	DDR4 Component Address 15
DDR4_COMP_A14	T4	1.2 V HS LVCMOS	DDR4 Component Address 14
DDR4_COMP_A13	U3	1.2 V HS LVCMOS	DDR4 Component Address 13
DDR4_COMP_A12	Y6	1.2 V HS LVCMOS	DDR4 Component Address 12
DDR4_COMP_A11	Y8	1.2 V HS LVCMOS	DDR4 Component Address 11
DDR4_COMP_A10	W7	1.2 V HS LVCMOS	DDR4 Component Address 10
DDR4_COMP_A9	T8	1.2 V HS LVCMOS	DDR4 Component Address 9
DDR4_COMP_A8	U7	1.2 V HS LVCMOS	DDR4 Component Address 8
DDR4_COMP_A7	Y10	1.2 V HS LVCMOS	DDR4 Component Address 7
DDR4_COMP_A6	W9	1.2 V HS LVCMOS	DDR4 Component Address 6
DDR4_COMP_A5	T10	1.2 V HS LVCMOS	DDR4 Component Address 5
DDR4_COMP_A4	U9	1.2 V HS LVCMOS	DDR4 Component Address 4
DDR4_COMP_A3	Y12	1.2 V HS LVCMOS	DDR4 Component Address 3
DDR4_COMP_A2	W11	1.2 V HS LVCMOS	DDR4 Component Address 2
DDR4_COMP_A1	T12	1.2 V HS LVCMOS	DDR4 Component Address 1
DDR4_COMP_A0	U11	1.2 V HS LVCMOS	DDR4 Component Address 0
DDR4_COMP_PAR	P8	1.2 V HS LVCMOS	DDR4 Component Parity
DDR4_COMP_CK_N	M8	1.2 V HS LVCMOS	DDR4 DIMM2 Clock Negative
DDR4_COMP_CK_P	L7	1.2 V HS LVCMOS	DDR4 DIMM2 Clock Positive
DDR4_COMP_CKE	R9	1.2 V HS LVCMOS	DDR4 Component Clock Enable
			<i>continued...</i>

Schematic Signal Name	FPGA Pin Number	I/O Standard	Description
DDR4_COMP_ODT	L9	1.2 V HS LVCMOS	DDR4 Component On Die Termination
DDR4_COMP_ACT_N	P12	1.2 V HS LVCMOS	DDR4 Component Activate
DDR4_COMP_CS_N	R11	1.2 V HS LVCMOS	DDR4 Component Chip Select
DDR4_COMP_RESET_N	M12	1.2 V HS LVCMOS	DDR4 Component Reset
DDR4_COMP_BG1	L11	1.2 V HS LVCMOS	DDR4 Component Bank Group 1

### A.5.8. HPS I/O48 Interface

An HPS I/O48 daughter card is pre-installed with each development kit board.

The Intel Agilex FPGA (two F-tiles) development board connects the 48 HPS I/Os (HPS\_IOA[24:1] and HPS\_IOB[24:1]) to a mezzanine connector for installing the Intel HPS I/O48 daughter card. This daughter card provides the HPS with USB, UART, Ethernet, SD card, I<sup>2</sup>C, and JTAG accessibility.

**Table 36. HPS Pin Assignments**

Schematic Signal Name	FPGA Pin Number	I/O Standard	Description
HPS_GPIO0	AC15	1.8 V LVCMOS	USB Clock
HPS_GPIO1	AL15	1.8 V LVCMOS	USB STP
HPS_GPIO2	AJ11	1.8 V LVCMOS	USB DIR
HPS_GPIO3	AM16	1.8 V LVCMOS	USB Data 0
HPS_GPIO4	AH12	1.8 V LVCMOS	USB Data 1
HPS_GPIO5	AN15	1.8 V LVCMOS	USB NXT
HPS_GPIO6	AG13	1.8 V LVCMOS	USB Data 2
HPS_GPIO7	AP16	1.8 V LVCMOS	USB Data 3
HPS_GPIO8	AF14	1.8 V LVCMOS	USB Data 4
HPS_GPIO9	AT16	1.8 V LVCMOS	USB Data 5
HPS_GPIO10	AH10	1.8 V LVCMOS	USB Data 6
HPS_GPIO11	AU15	1.8 V LVCMOS	USB Data 7
HPS_GPIO12	AJ7	1.8 V LVCMOS	Ethernet TX Clock
HPS_GPIO13	AL13	1.8 V LVCMOS	Ethernet TX Enable
HPS_GPIO14	AH8	1.8 V LVCMOS	Ethernet RX Clock
HPS_GPIO15	AM14	1.8 V LVCMOS	Ethernet RX Data Valid
HPS_GPIO16	AD14	1.8 V LVCMOS	Ethernet TX Data 0
HPS_GPIO17	AN13	1.8 V LVCMOS	Ethernet TX Data 1
HPS_GPIO18	AG11	1.8 V LVCMOS	Ethernet RX Data 0
HPS_GPIO19	AP14	1.8 V LVCMOS	Ethernet RX Data 1
HPS_GPIO20	AG9	1.8 V LVCMOS	Ethernet TX Data 2
HPS_GPIO21	AT14	1.8 V LVCMOS	Ethernet TX Data 3

*continued...*

Schematic Signal Name	FPGA Pin Number	I/O Standard	Description
HPS_GPIO22	AF12	1.8 V LVCMOS	Ethernet RX Data 2
HPS_GPIO23	AU13	1.8 V LVCMOS	Ethernet RX Data 3
HPS_GPIO24	AF10	1.8 V LVCMOS	GPIO IO0
HPS_GPIO25	AU11	1.8 V LVCMOS	GPIO IO1
HPS_GPIO26	AF8	1.8 V LVCMOS	UART TX
HPS_GPIO27	AT12	1.8 V LVCMOS	UART RX
HPS_GPIO28	AG7	1.8 V LVCMOS	GPIO IO4
HPS_GPIO29	AP12	1.8 V LVCMOS	GPIO IO5
HPS_GPIO30	AC13	1.8 V LVCMOS	I2C SDA
HPS_GPIO31	AN11	1.8 V LVCMOS	I2C SCL
HPS_GPIO32	AD12	1.8 V LVCMOS	JTAG TCK
HPS_GPIO33	AM12	1.8 V LVCMOS	JTAG TMS
HPS_GPIO34	AD10	1.8 V LVCMOS	JTAG TDO
HPS_GPIO35	AL11	1.8 V LVCMOS	JTAG TDI
HPS_GPIO36	AC11	1.8 V LVCMOS	SD Card Data 0
HPS_GPIO37	AT10	1.8 V LVCMOS	SD Card Command
HPS_GPIO38	AD8	1.8 V LVCMOS	SD Card Clock
HPS_GPIO39	AP10	1.8 V LVCMOS	SD Card Data 1
HPS_GPIO40	AC9	1.8 V LVCMOS	SD Card Data 2
HPS_GPIO41	AM10	1.8 V LVCMOS	SD Card Data 3
HPS_GPIO42	AB10	1.8 V LVCMOS	OSC Clock
HPS_GPIO43	AJ13	1.8 V LVCMOS	GPIO IO19
HPS_GPIO44	AB14	1.8 V LVCMOS	GPIO IO20
HPS_GPIO45	AH14	1.8 V LVCMOS	GPIO IO21
HPS_GPIO46	AB12	1.8 V LVCMOS	Ethernet MDIO
HPS_GPIO47	AJ9	1.8 V LVCMOS	Ethernet MDC

## A.6. I<sup>2</sup>C

The Intel MAX 10 and Intel Agilex devices use the I<sup>2</sup>C for reading and writing to the various components on the board such as programmable clock generators, voltage regulators, temperature sensors, and EEPROMs. You can use the Intel Agilex or Intel MAX 10 as the I<sup>2</sup>C host to access these devices, change clock frequencies, or get board status information such as the voltage and temperature readings.

Figure 25. I<sup>2</sup>C Block Diagram

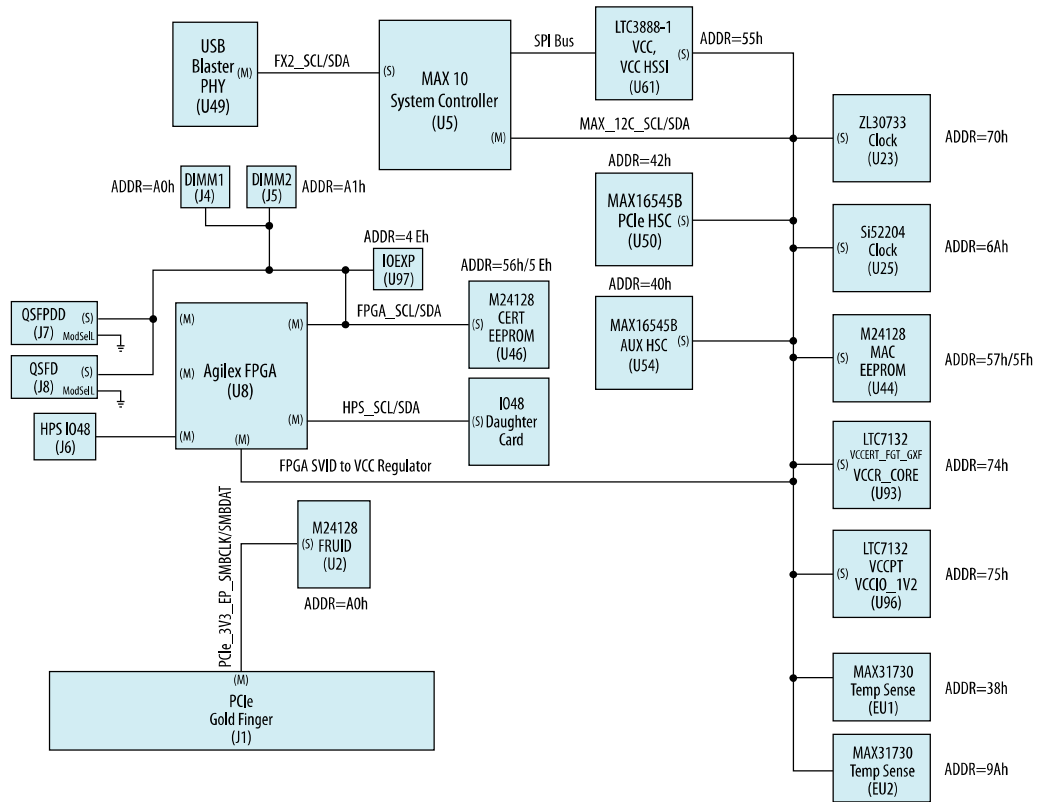

Table 37. Intel MAX 10 I<sup>2</sup>C Signals

Schematic Signal Name	MAX Pin Number	I/O Standard	Description
MAX_I2C_SCL	J11	3.3 V open drain	Intel MAX 10 I <sup>2</sup> C clock
MAX_I2C_SDA	J12	3.3 V open drain	Intel MAX 10 I <sup>2</sup> C data
FX2_SCL	R1	3.3 V open drain	USB PHY I <sup>2</sup> C clock
FX2_SDA	R3	3.3 V open drain	USB PHY I <sup>2</sup> C data

Table 38. FPGA I<sup>2</sup>C Signals

Schematic Signal Name	FPGA Pin Number	I/O Standard	Description
FPGA_1V8_SVID_SCL	CG47	1.8 V open drain	Serial voltage ID I <sup>2</sup> C clock
FPGA_1V8_SVID_SDA	CB46	1.8 V open drain	Serial voltage ID I <sup>2</sup> C data
FPGA_1V2_SCL	K44	1.2 V open drain	FPGA I <sup>2</sup> C clock for DDR4 DIMMs, QSFP, QSFDD, IO expander, and certificate EEPROM
FPGA_1V2_SDA	J43	1.2 V open drain	FPGA I <sup>2</sup> C data for DDR4 DIMMs, QSFP, QSFDD, IO expander, and certificate EEPROM
HPS_SCL	N3	1.8 V open drain	HPS I/O48 daughter card I <sup>2</sup> C clock
HPS_SDA	L6	1.8 V open drain	HPS I/O48 daughter card I <sup>2</sup> C data

## A.7. Intel MAX 10 SPI Bus

The Intel MAX 10 device uses the SPI bus for reading telemetry information from the Analog Devices LTC3888 VCC core controller.

**Table 39. SPI Signals**

Schematic Signal Name	FPGA Pin Number	I/O Standard	Description
LTC_1V8_SDI	L2	1.8 V CMOS	SPI data
LTC_1V8_SCK	N2	1.8 V CMOS	SPI clock
LTC_1V8_SPI_ERRn	M1	1.8 V CMOS	SPI error status
LTC_1V8_SCSn	P1	1.8 V CMOS	SPI chip select

## A.8. Clock Circuits

**Figure 26. Intel Agilix F-Series FPGA Development Kit Clocks and Default Frequencies**

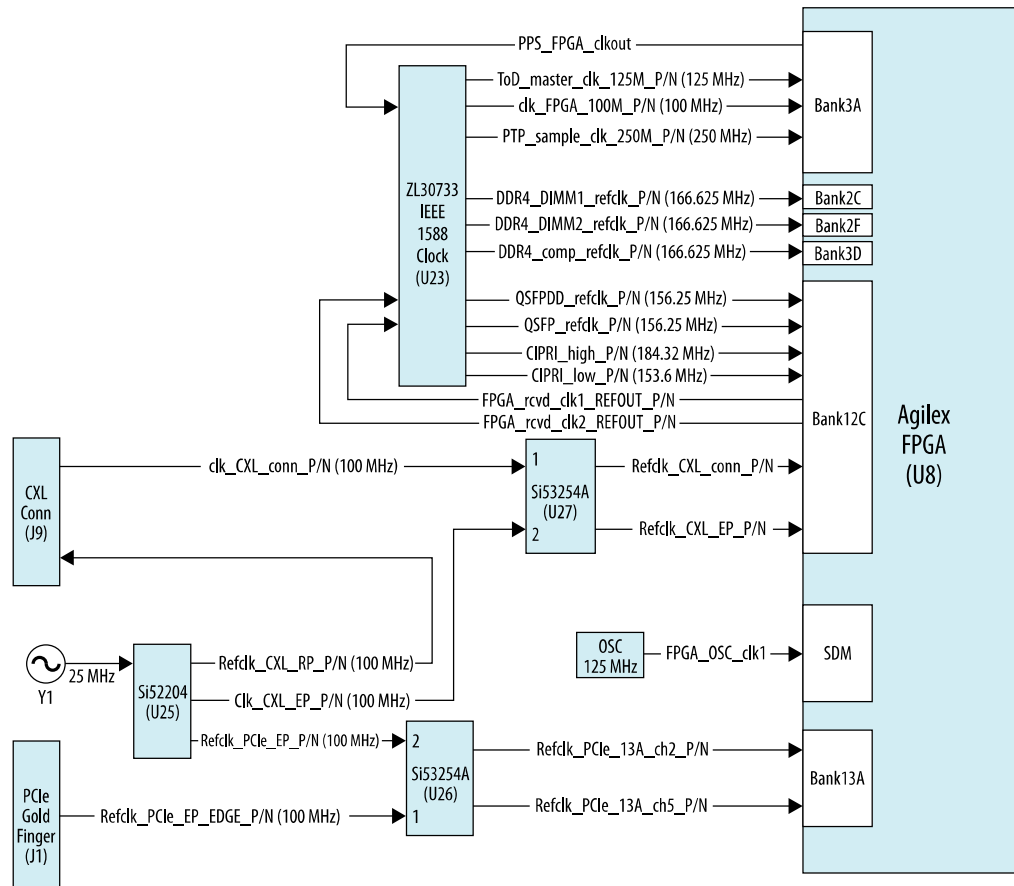

**Table 40. On-Board Oscillators Sources for the FPGA**

Source	Schematic Signal Name	Frequency	I/O Standard	Intel Agilex Pin Number (P/N)	Application
U23	TOD_MASTER_CLK_125M_P/N	125 Mhz	Differential	G43/F44	IEEE 1588 TOD master clock
	CLK_FPGA_100M_P/N	100 Mhz	LVDS	CK18/CL19	General-purpose FPGA clock
	PTP_SAMPLE_CLK_250M_P/N	250 Mhz	Differential	E45/D46	IEEE 1588 PTP clock
	DDR4_DIMM1_REFCLK_P/N	166.625 Mhz	LVDS	CV28/CW29	DDR4 DIMM1 clock
	DDR4_DIMM2_REFCLK_P/N	166.625 Mhz	LVDS	DD36/DC37	DDR4 DIMM2 clock
	DDR4_COMP_REFCLK_P/N	166.625 Mhz	LVDS	U5/T6	DDR4 component clock
	QSFP_REFCLK_P/N	156.25 Mhz	Differential	AW49/AV48	QSFP clock
	QSFPDD_REFCLK_P/N	156.25 Mhz	Differential	AD48/AC49	QSFPDD clock
	CIPRI_HIGH_REFCLK_P/N	184.32 Mhz	Differential	AJ48/AH49	CIPRI high clock
CIPRI_LOW_REFCLK_P/N	153.6 Mhz	Differential	AR49/AU49	CIPRI low clock	
U27	REFCLK_CXL_CONN_P/N	100 Mhz	HCSL	BG49/BF48	PCIe REFCLK bank 12C channel 1
	REFCLK_CXL_EP_P/N	100 Mhz	HCSL	BC49/BE49	PCIe REFCLK bank 12C channel 0
U26	REFCLK_PCIE_13A_CH2_P/N	100 Mhz	HCSL	BR7/BU7	PCIe REFCLK bank 13A channel 2
	REFCLK_PCIE_13A_CH5_P/N	100 Mhz	HCSL	CD8/CC7	PCIe REFCLK bank 13A channel 5
U10	FPGA_OSC_CLK1	125 Mhz	1.8 V LVCMOS	CB42	Configuration clock

## A.9. HPS Daughter Card

The development kit includes an Intel HPS daughter card that mounts to a Samtec 48-pin connector (**J6**) and connects to the Intel Agilex HPS I/O 48 bank. The HPS daughter card provides SoC port functionality to the development kit. These ports include Ethernet, USB, UART, I<sup>2</sup>C, JTAG, and a SD memory card slot. For more information, refer to the [HPS IO-48 OOB Daughter Card](#).



Figure 27. HPS Daughter Card



Table 41. HPS I/O 48 Signals

Schematic Signal Name	FPGA Pin Number	I/O Standard	Description
HPS_GPIO0	AC15	1.8 V LVCMOS	USB clock
HPS_GPIO1	AL15	1.8 V LVCMOS	USB STP
HPS_GPIO2	AJ11	1.8 V LVCMOS	USB DIR
HPS_GPIO3	AM16	1.8 V LVCMOS	USB DATA0
HPS_GPIO4	AH12	1.8 V LVCMOS	USB DATA1
HPS_GPIO5	AN15	1.8 V LVCMOS	USB NXT
HPS_GPIO6	AG13	1.8 V LVCMOS	USB DATA2
HPS_GPIO7	AP16	1.8 V LVCMOS	USB DATA3
HPS_GPIO8	AF14	1.8 V LVCMOS	USB DATA4
HPS_GPIO9	AT16	1.8 V LVCMOS	USB DATA5
HPS_GPIO10	AH10	1.8 V LVCMOS	USB DATA6
HPS_GPIO11	AU15	1.8 V LVCMOS	USB DATA7
HPS_GPIO12	AJ7	1.8 V LVCMOS	Ethernet TX clock
HPS_GPIO13	AL13	1.8 V LVCMOS	Ethernet TX CTL
HPS_GPIO14	AH8	1.8 V LVCMOS	Ethernet RX clock
HPS_GPIO15	AM14	1.8 V LVCMOS	Ethernet RX CTL
HPS_GPIO16	AD14	1.8 V LVCMOS	Ethernet TX Data0
HPS_GPIO17	AN13	1.8 V LVCMOS	Ethernet TX Data1
HPS_GPIO18	AG11	1.8 V LVCMOS	Ethernet RX Data0
HPS_GPIO19	AP14	1.8 V LVCMOS	Ethernet RX Data1

*continued...*

Schematic Signal Name	FPGA Pin Number	I/O Standard	Description
HPS_GPIO20	AG9	1.8 V LVCMOS	Ethernet TX Data2
HPS_GPIO21	AT14	1.8 V LVCMOS	Ethernet TX Data3
HPS_GPIO22	AF12	1.8 V LVCMOS	Ethernet RX Data2
HPS_GPIO23	AU13	1.8 V LVCMOS	Ethernet RX Data3
HPS_GPIO24	AF10	1.8 V LVCMOS	GPIO I/O 0
HPS_GPIO25	AU11	1.8 V LVCMOS	GPIO I/O 1
HPS_GPIO26	AF8	1.8 V LVCMOS	UART TX
HPS_GPIO27	AT12	1.8 V LVCMOS	UART RX
HPS_GPIO28	AG7	1.8 V LVCMOS	GPIO I/O 4
HPS_GPIO29	AP12	1.8 V LVCMOS	GPIO I/O 5
HPS_GPIO30	AC13	1.8 V LVCMOS	I <sup>2</sup> C SDA
HPS_GPIO31	AN11	1.8 V LVCMOS	I <sup>2</sup> C SCL
HPS_GPIO32	AD12	1.8 V LVCMOS	JTAG TCK
HPS_GPIO33	AM12	1.8 V LVCMOS	JTAG TMS
HPS_GPIO34	AD10	1.8 V LVCMOS	JTAG TDO
HPS_GPIO35	AL11	1.8 V LVCMOS	JTAG TDI
HPS_GPIO36	AC11	1.8 V LVCMOS	SDMMC Data0
HPS_GPIO37	AT10	1.8 V LVCMOS	SDMMC CMD
HPS_GPIO38	AD8	1.8 V LVCMOS	SDMMC clock
HPS_GPIO39	AP10	1.8 V LVCMOS	SDMMC Data1
HPS_GPIO40	AC9	1.8 V LVCMOS	SDMMC Data2
HPS_GPIO41	AM10	1.8 V LVCMOS	SDMMC Data3
HPS_GPIO42	AB10	1.8 V LVCMOS	Clock
HPS_GPIO43	AJ13	1.8 V LVCMOS	GPIO I/O 19
HPS_GPIO44	AB14	1.8 V LVCMOS	GPIO I/O 20
HPS_GPIO45	AH14	1.8 V LVCMOS	GPIO I/O 21
HPS_GPIO46	AB12	1.8 V LVCMOS	Ethernet MDIO
HPS_GPIO47	AJ9	1.8 V LVCMOS	Ethernet MDC

## A.10. System Power

This section describes the Intel Agilex FPGA development board's power supply. A laptop style DC power supply is provided with the development kit. Use only the supplied power supply. The power supply has an auto sensing input voltage of 100 – 240 V AC power and output of 12 V DC power at 20 A to the development board. The 12 V DC input power is then stepped down to various power rails used by the board components.

Power telemetry is provided via the Intel MAX 10 and I<sup>2</sup>C interface to the various voltage regulators and temperature sensors on the board. The power utilization is displayed on a GUI that shows power consumption versus time.

## A.11. Power Guidelines

The Intel Agilex FPGA development kit has two modes of operation.

### A.11.1. In a Standard PCIe-Compliant System

In this mode, plug the board into an available PCI Express (PCIe) slot and connect the standard 2 x 4 auxiliary power cord available from the PC's ATX power supply to the respective mating power connector on the board (**J11**). The PCIe slot together with the auxiliary PCIe power are required to power the entire board. If you do not connect the 2 x 4 auxiliary power connections, the board will not power on when installed in a PCIe system. The power switch SW5 is ignored when the board is used in the PCIe system.

**Figure 28. In a Standard PCIe-Compliant System**

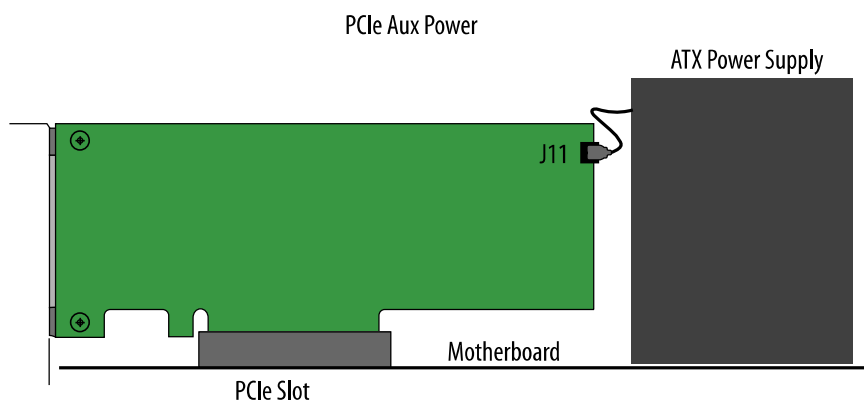

### A.11.2. As a Standalone Evaluation Board Powered by Included Power Supply

In this mode, plug the included power supply into the 2 x 4 pin connector (**J11**) and the AC power cord of the power supply into a power outlet.

*Note:* The power supply connector is a 2 x 3 pin connector but is keyed to mate with 6 pins of the **J11** power input on the board.

This power supply provides the entire power to the board without the need to obtain power from the PCIe slot. The power switch SW5 controls powering the board on or off.



## A.13. Power Measurement

There are eight power supply rails that have on-board voltage, current, and wattage sense capabilities. An I<sup>2</sup>C bus connects seven of these voltage regulator devices to the Intel MAX 10 system controller for power telemetry data reporting. The V<sub>CC</sub> rail for the FPGA core power is measured by the Intel MAX 10 using the SPI bus interface between the Intel MAX 10 and VCC core controller. The Intel MAX 10 provides power data through the Power Monitor GUI.

Figure 31. Power Monitor GUI

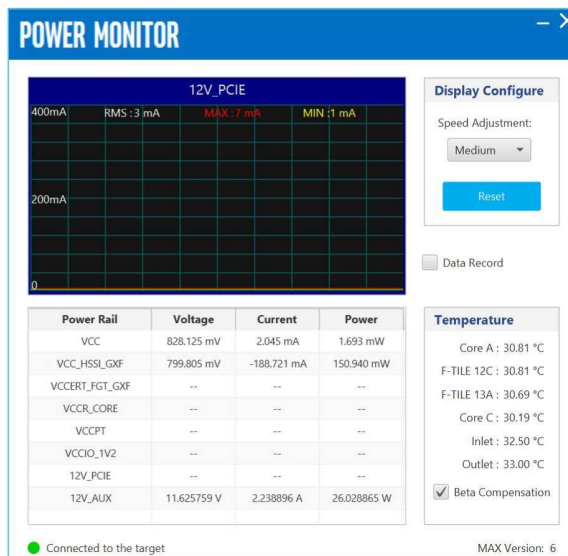

## A.14. Thermal Limitations and Protection

The Intel Agilex FPGA development kit is designed to operate in a typical laboratory environment with an ambient temperature of approximately 25 °C. The cooling solution provided with the development kit allows sufficient cooling for the board to operate up to a maximum power consumption of 150 W (under this environment).

Two MAX31730 3-channel remote temperature sensor devices are connected to the Intel Agilex FPGA's internal temperature diodes. The function is to continuously monitor the FPGA's internal core and transceiver tile die temperatures as well as the board inlet and exhaust airflow temperatures when the board is installed inside a server system. Based on the data from both temperature sensors, the Intel Agilex FPGA and Intel MAX 10 run at its maximum speed whenever any temperature is over 60 °C or immediately power off the board whenever the temperature crosses 100 °C to protect the board from damage.

**Caution:** Ensure you unplug the power supply when the board is powered off when the temperature crosses 100 °C. Plug the power supply back again to ensure that the board can be turned on or off again.

## B. Additional Information

---

### B.1. Safety and Regulatory Information



#### **ENGINEERING DEVELOPMENT PRODUCT - NOT FOR RESALE OR LEASE**

This development kit is intended for laboratory development and engineering use only.

This development kit is designed to allow:

- Product developers and system engineers to evaluate electronic components, circuits, or software associated with the development kit to determine whether to incorporate such items in a finished product.
- Software developers to write software applications for use with the end product.

This kit is not a finished product and when assembled may not be resold or otherwise marketed unless all required Federal Communications Commission (FCC) equipment authorizations are first obtained.

Operation is subject to the condition that this product not cause harmful interference to licensed radio stations and that this product accept harmful interference.

Unless the assembled kit is designed to operate under Part 15, Part 18 or Part 95 of the United States Code of Federal Regulations (CFR) Title 47, the operator of the kit must operate under the authority of an FCC licenseholder or must secure an experimental authorization under Part 5 of the United States CFR Title 47.

Safety Assessment and CE & UKCA mark requirements have been completed, however, other certifications that may be required for installation and operation in your region have not been obtained.

### B.1.1. Safety Warnings

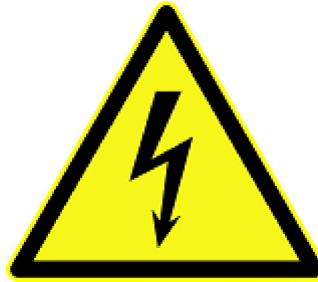



#### Power Supply Hazardous Voltage

AC mains voltages are present within the power supply assembly. No user serviceable parts are present inside the power supply.

#### Power Connect and Disconnect

The AC power supply cord is the primary disconnect device from mains (AC power) and used to remove all DC power from the board/system. The socket outlet must be installed near the equipment and must be readily accessible.

	<b>WARNING</b>	
<b>RISK OF ELECTRIC SHOCK</b>		
Connect only to a properly earth grounded outlet. Apparaten skall anslutas till jordat uttag när den ansluts till ett nätverk.		

#### System Grounding (Earthing)

To avoid shock, you must ensure that the power cord is connected to a properly wired and grounded receptacle. Ensure that any equipment to which this product is attached to is also connected to properly wired and grounded receptacles.

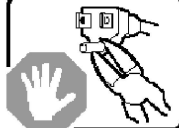
	<b>WARNING</b>	
<b>RISK OF ELECTRIC SHOCK</b>		
Do not attempt to modify or use the supplied AC power cord if it is not the exact type and rating required.		

### Power Cord Requirements

The connector that plugs into the wall outlet must be a grounding-type male plug designed for use in your region. It must have marks showing certification by an agency in your region. The connector that plugs into the AC receptacle on the power supply must be an IEC 320, sheet C13, female connector. For more information, refer to <http://kropla.com/electric2.htm>. If the power cord supplied with the system does not meet requirements for use in your region, discard the cord and do not use it with adapters.

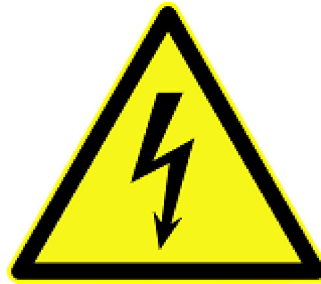

### Lightning/Electrical Storm

Do not connect/disconnect any cables or perform installation/maintenance of this product during an electrical storm.

### Risk of Fire

To reduce the risk of fire, keep all flammable materials a safe distance away from the boards and power supply. You must configure the development kit on a flame retardant surface.

## B.1.2. Safety Cautions

	<h3>CAUTION</h3>	
	<h4>Hot Surfaces and Sharp Edges</h4>	
<p><b>Integrated Circuits and heat sinks may be hot if the system has been running. Also, there might be sharp pins and edges on some boards. Contact should be avoided.</b></p>		

**Caution:** Hot Surfaces and Sharp Edges. Integrated Circuits and heat sinks may be hot if the system has been running. Also, there might be sharp edges on some boards. Contact should be avoided.

### Thermal and Mechanical Injury

Certain components such as heat sinks, power regulators, and processors may be hot. Heatsink fans are not guarded. Power supply fan may be accessible through guard. Care should be taken to avoid contact with these components.





### Cooling Requirements

Maintain a minimum clearance area of 5 centimeters (2 inches) around the side, front and back of the board for cooling purposes. Do not block power supply ventilation holes and fan.

### Electro-Magnetic Interference (EMI)

This equipment has not been tested for compliance with emission limits of FCC and similar international regulations. Use of this equipment in a residential location is prohibited. This equipment generates, uses and can radiate radio frequency energy which may result in harmful interference to radio communications. If this equipment does cause harmful interference to radio or television reception, which can be determined by turning the equipment on and off, you are required to take measures to eliminate this interference.

### Telecommunications Port Restrictions

The wireline telecommunications ports (modem, xDSL, T1/E1) on this product must not be connected to the Public Switched Telecommunication Network (PSTN) as it might result in disruption of the network. No formal telecommunication certification to FCC, R&TTE Directive, or other national requirements have been obtained.



### Electrostatic Discharge (ESD) Warning

A properly grounded ESD wrist strap must be worn during operation/installation of the boards, connection of cables, or during installation or removal of daughter cards. Failure to use wrist straps can damage components within the system.

**Attention:** Please return this product to Intel for proper disposition. If it is not returned, refer to local environmental regulations for proper recycling. Do not dispose of this product in unsorted municipal waste.

### Lithium Ion Battery Warnings



**Lithium Battery:** Risk of explosion if the lithium battery is replaced by an incorrect type. Risk of fire, explosion, or chemical burn if the battery is mistreated (punctured or crushed). Do not attempt to disassemble. Do not incinerate. Observe proper polarity when replacing battery. Do not dispose—the battery is intended to be serviced and disposed by qualified Intel service personnel only.

**Perchlorate Material:** Special handling may apply. For more details, refer to [www.dtsc.ca.gov/hazardouswaste/perchlorate](http://www.dtsc.ca.gov/hazardouswaste/perchlorate). This notice is required by California Code of Regulations, Title 22, Division 4.5, Chapter 33: Best Management Practices for Perchlorate Materials. This product includes a battery which contains perchlorate material.

### Taiwan battery recycling:



廢電池請回收

(Translation - please recycle batteries)

**Please return this product to Intel for proper disposition. If it is not returned, refer to local environmental regulations for proper recycling. Do not dispose of product in unsorted municipal waste.**

## **B.2. Compliance Information**

### **CE EMI Conformity Caution**

This development board is delivered conforming to relevant standards mandated by Directive 2014/30/EU. Because of the nature of programmable logic devices, it is possible for the user to modify the development kit in such a way as to generate electromagnetic interference (EMI) that exceeds the limits established for this equipment. Any EMI caused as a result of modifications to the delivered material is the responsibility of the user of this development kit.

