

18x8 DOTS MATRIX LED DRIVER EVALUATION BOARD GUIDE

DESCRIPTION

The IS31FL3745 is a general purpose 18x n ($n=1\sim 8$) LED Matrix programmed via 1MHz I2C compatible interface. Each LED can be dimmed individually with 8-bit PWM data and 8-bit DC scaling data which allowing 256 steps of linear PWM dimming and 256 steps of DC current adjustable level.

Additionally each LED open and short state can be detected, IS31FL3745 store the open or short information in Open-Short Registers. The Open-Short Registers allowing MCU to read out via I2C compatible interface. Inform MCU whether there are LEDs open or short and the locations of open or short LEDs.

FEATURES

- Supply voltage range: 2.7V to 5.5V
- 18 Current sink (Maximum)
- Support 18 x n ($n=1\sim 8$) LED matrix configurations
- Individual 256 PWM control steps
- Individual 256 DC current steps
- Global 256 current setting
- SDB rising edge reset I2C module
- Programmable H/L logic: 1.4/0.4, 2.4/0.6
- 29kHz PWM frequency
- State lookup registers
- Individual open and short error detect function
- 180 degree phase delay operation to reduce power noise
- De-ghost
- Cascade for synchronization of chips

QUICK START

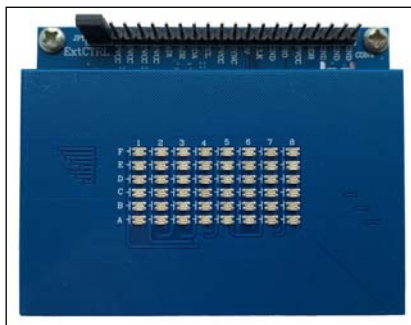

Figure 1: Photo of IS31FL3745-CLS4 Evaluation Board

RECOMMENDED EQUIPMENT

- 5.0V, 2A power supply

ABSOLUTE MAXIMUM RATINGS

- $\leq 5.5V$ power supply

Caution: Do not exceed the conditions listed above, otherwise the board will be damaged.

PROCEDURE

The IS31FL3745 evaluation board is fully assembled and tested. Follow the steps listed below to verify board operation.

Caution: Do not turn on the power supply until all connections are completed.

- 1) Short JP1 (OPEN=EXT CTRL) to enable the control of on board MCU (default status).
- 2) Connect the 5V DC power to VCC / GND in CON4, or plug in the USB power input to micro-USB (CON5).
- 3) Turn on the power supply, pay attention to the supply current. If the current exceeds 1A, please check for circuit fault.

EVALUATION BOARD OPERATION

The IS31FL3745 evaluation board has six display modes. Press K1 to switch configurations.

- 1) (Default mode) Rainbow #1.
- 2) Rainbow #2.
- 3) Purple breath.
- 4) Change colors.
- 5) White.

Note: IS31FL3745 solely controls the FxLED function on the evaluation board.

ORDERING INFORMATION

| Part No. | Temperature Range | Package |
|--------------------|------------------------------|---------------------|
| IS31FL3745-CLS4-EB | -40°C to +125°C (Industrial) | WLCSP-36, Lead-free |

Table 1: Ordering Information

For pricing, delivery, and ordering information, please contacts Lumissil's analog marketing team at analog@Lumissil.com or (408) 969-6600

18x8 DOTS MATRIX LED DRIVER EVALUATION BOARD GUIDE

SOFTWARE SUPPORT

EXT CTRL (JP1) default setting is close circuit. If it is set to open, the on-board MCU will configure the I2C pins and SDB pin to High Impedance and sleep. External I2C and SDB signals can be connected to TP4 to control the IS31FL3745 LED driver.

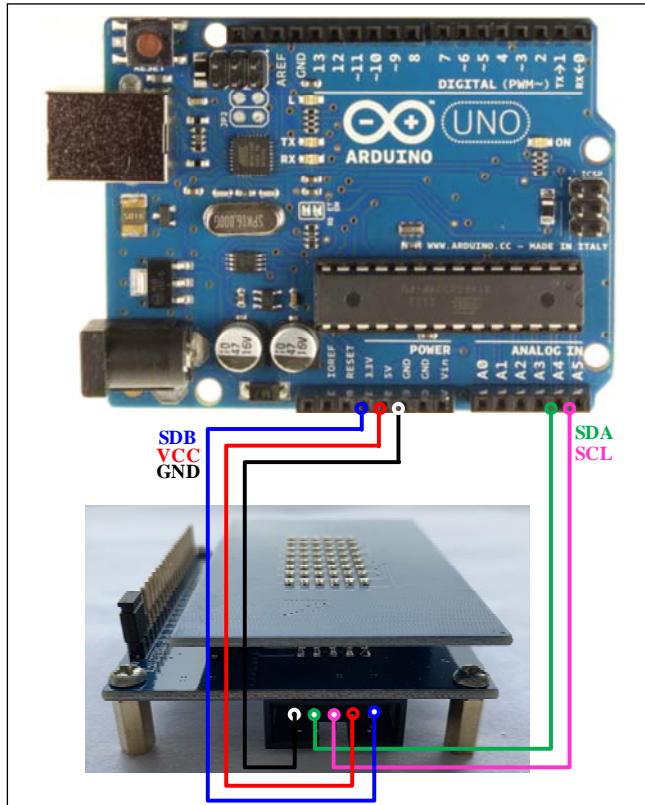

Figure 2: Photo of Arduino UNO connected to Evaluation Board

The steps listed below are an example using the Arduino for external control.

The Arduino hardware consists of an Atmel microcontroller with a bootloader allowing quick firmware updates. First download the latest Arduino Integrated Development Environment IDE (1.6.12 or greater) from www.arduino.cc/en/Main/Software. Also download the Wire.h library from www.arduino.cc/en/reference/wire and verify that pgmspace.h is in the directory ...program Files(x86)/Arduino/hardware/tools/avr/avr/include/avr/. Then download the latest IS31FL3745 test firmware (sketch) from the Lumissil website <http://www.lumissil.com/products/led-driver/fxled>.

- 1) Open EXT CTRL (JP1).
- 2) Connect the 5 pins from Arduino board to IS31FL3745 EVB:
 - a) Arduino 5V pin to IS31FL3745 EVB VCC.
 - b) Arduino GND to IS31FL3745 EVB GND.
 - c) Arduino SDA (A4) to IS31FL3745 EVB SDA.
 - d) Arduino SCL (A5) to IS31FL3745 EVB SCL.
 - e) If Arduino use 3.3V MCU VCC, connect 3.3V to IS31FL3745 EVB SDB, if Arduino use 5.0V MCU VCC, connect 5.0V or 3.3V to EVB SDB.
(Arduino UNO MCU VCC is 5V, so SDB can be 5V or 3.3V)
- 3) Use the test code in appendix I or download the test firmware (sketch) from the Lumissil website, a .txt file and copy the code to Arduino IDE, compile and upload to Arduino.
- 4) Run the Arduino code for desired mode setting by Arduino code.

Please refer to the datasheet to get more information about IS31FL3745.

18x8 DOTS MATRIX LED DRIVER EVALUATION BOARD GUIDE

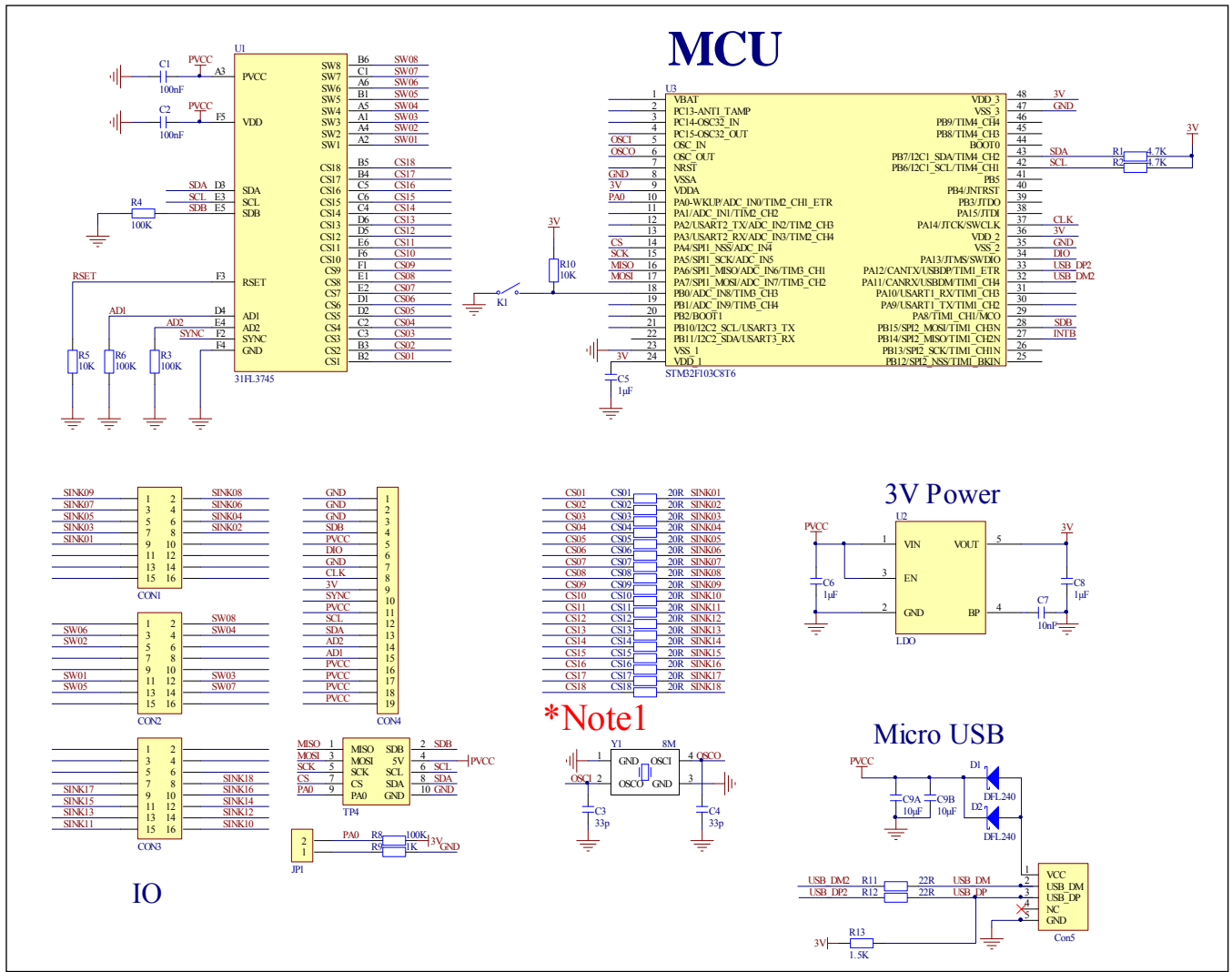

Figure 3: IS31FL3745 Application Schematic

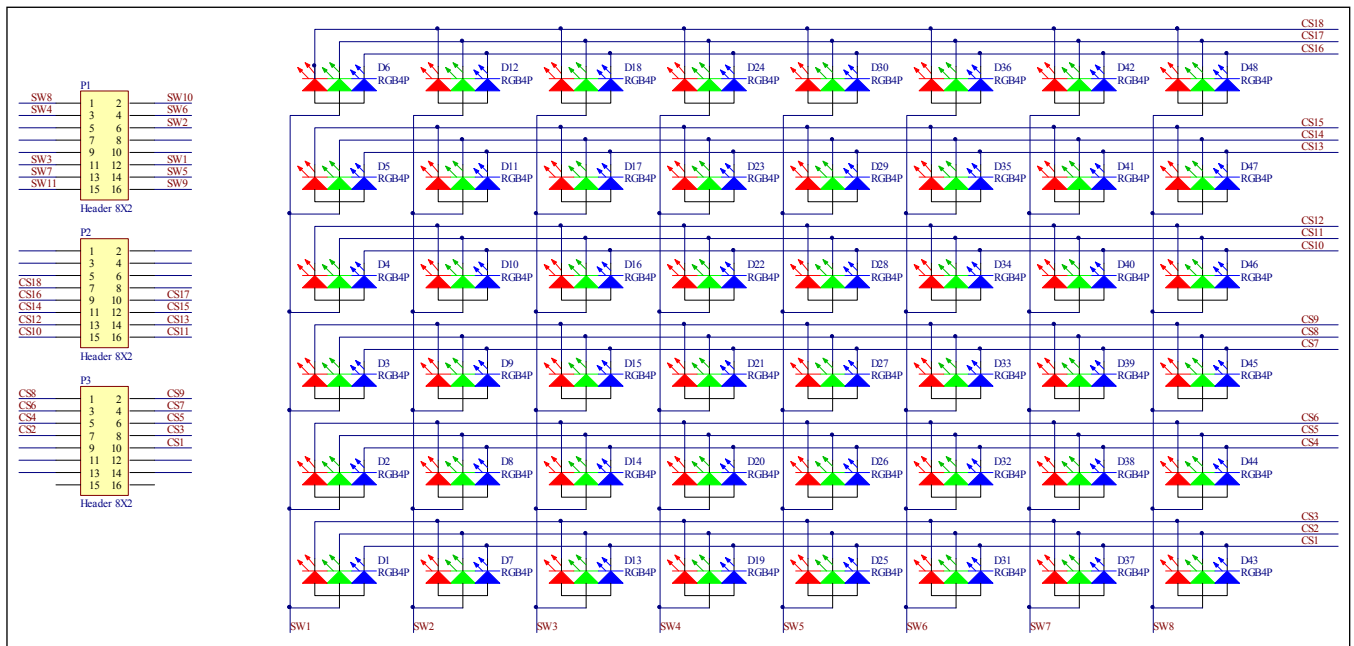

Figure 4: FxLED_6x8_ARRAY Schematic

18x8 DOTS MATRIX LED DRIVER EVALUATION BOARD GUIDE

BILL OF MATERIALS

IS31FL3745

| Name | Symbol | Description | Qty | Supplier | Part No. |
|------------|---|-----------------------------------|-----|----------|-------------------|
| LED Driver | U1 | Matrix LED Driver | 1 | Lumissil | IS31FL3745 |
| LDO | U2 | 3.0V LDO | 1 | SGMICRO | SGM2019-3.0YN5G |
| MCU | U3 | Microcontroller | 1 | STM | STM32F103C8T6 |
| Crystal | Y1 | Crystal, 8MHz | 1 | HLX | HC-49S |
| Diode | D1,D2 | Diode, SMD | 2 | DIODES | DFLS240 |
| Resistor | CS01,CS02, CS04,CS05, CS07,CS08, CS10,CS11, CS13,CS14, CS16,CS17 | RES,20R,1/10W,±5%,SMD | 12 | Yageo | RC0603JR-0720RL |
| Resistor | CS03,CS06, CS09,CS12, CS15,CS18 | RES,20R,1/10W,±5%,SMD (Note 1) | 6 | Yageo | RC0603JR-0720RL |
| Resistor | R1,R2 | RES,4.7k,1/10W,±5%,SMD | 2 | Yageo | RC0603JR-074K7L |
| Resistor | R3,R4,R6,R8 | RES,100k,1/10W,±5%,SMD | 4 | Yageo | RC0603JR-07100KL |
| Resistor | R5,R10 | RES,10k,1/10W,±5%,SMD | 2 | Yageo | RC0603JR-0710KL |
| Resistor | R9 | RES,1k,1/10W,±5%,SMD | 1 | Yageo | RC0603JR-071KL |
| Resistor | R11,R12 | RES,22R,1/10W,±5%,SMD | 2 | Yageo | RC0603JR-0722RL |
| Resistor | R13 | RES,1.5k,1/10W,±5%,SMD | 1 | Yageo | RC0603JR-071K5L |
| Capacitor | C1,C2 | CAP,100nF,16V,±20%,SMD | 2 | Yageo | CC0603MRX7R7BB104 |
| Capacitor | C3,C4 | CAP,33pF,50V,±5%,SMD | 2 | Yageo | CQ0603JRNPO9BN360 |
| Capacitor | C5,C6,C8 | CAP,1µF,16V,±10%,SMD | 1 | Yageo | CC0603KRX7R7BB105 |
| Capacitor | C7 | CAP,10nF,16V,±10%,SMD | 1 | Yageo | CC0603KPX7R7BB103 |
| Capacitor | C9A,C9B | CAP,10µF,16V,±20%,SMD | 2 | Yageo | CC0805KKX7R7BB106 |
| Button | K1 | Button SMD | 1 | | |

Bill of Materials, refer to Figure 3 above.

FxLED 6x11 ARRAY

| Name | Symbol | Description | Qty | Supplier | Part No. |
|------|--------|--------------|-----|-----------|----------------------|
| LED | D1~D48 | RGB LED, SMD | 48 | Everlight | 9-237/R6GHBHC-A01/2T |

Bill of Materials, refer to Figure 4 above.

Note 1: The value of these resistors on the evaluation board is 20Ω. For $PV_{cc}=5V$ and red LED application, prefer 51Ω for these resistors as shown in datasheet Figure 1.

18x8 DOTS MATRIX LED DRIVER EVALUATION BOARD GUIDE

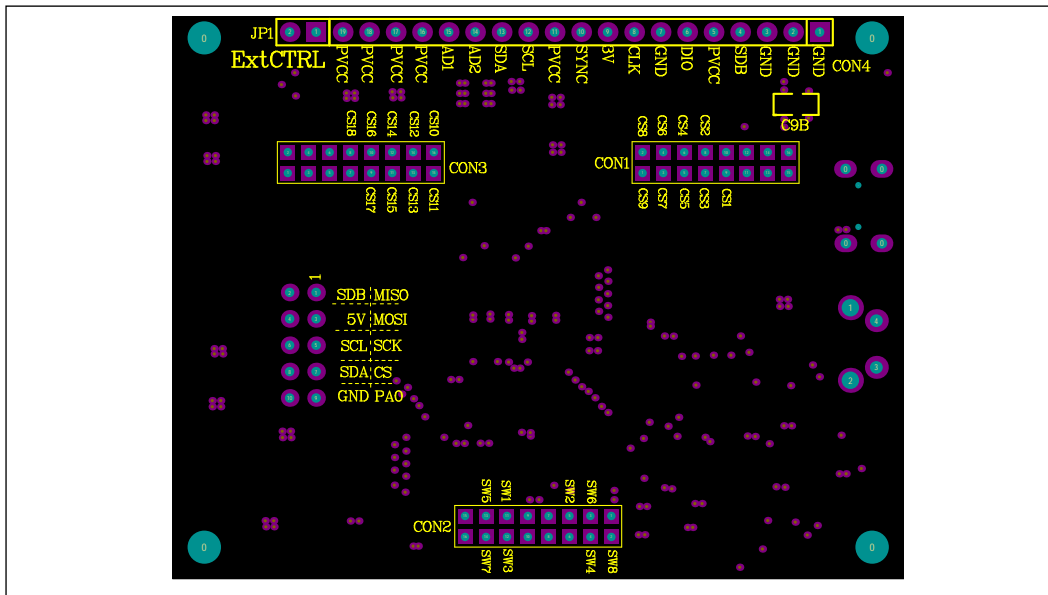

Figure 4: Board Component Placement Guide - Top Layer

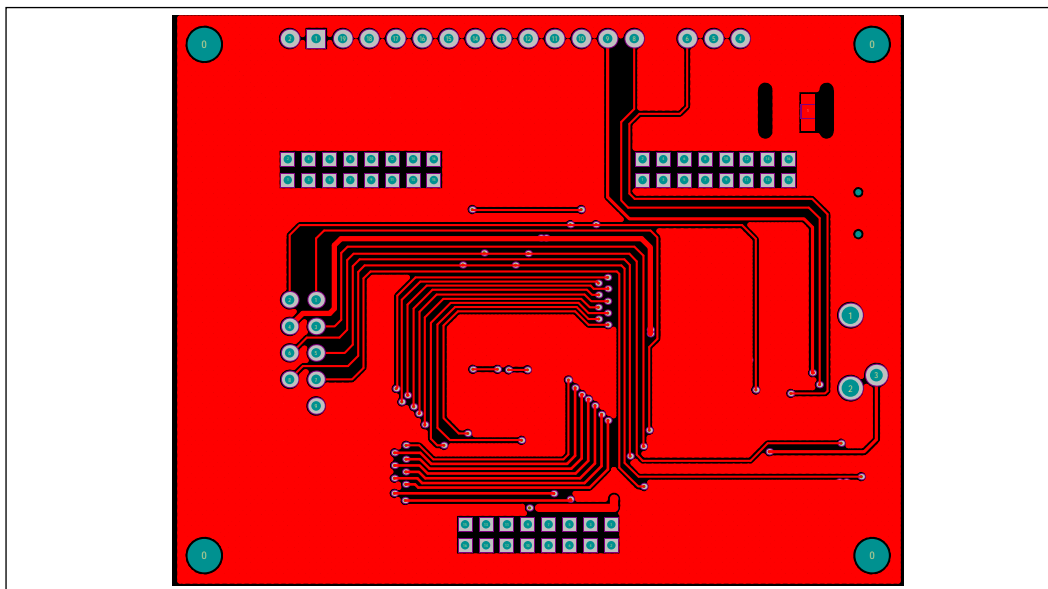

Figure 5: Board PCB Layout - Top Layer

18x8 DOTS MATRIX LED DRIVER EVALUATION BOARD GUIDE

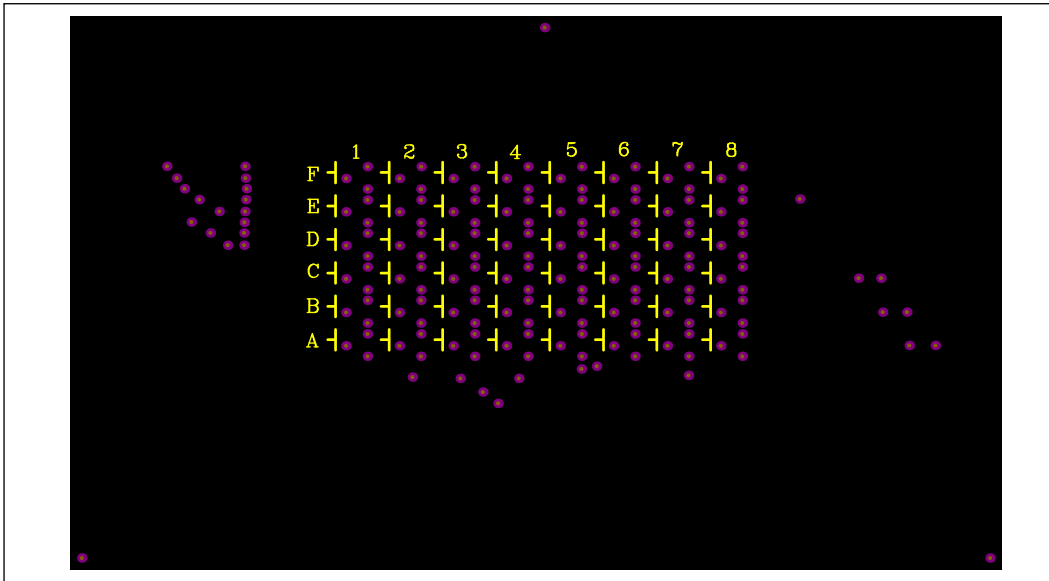

Figure 8: Board Component Placement Guide - Top Layer

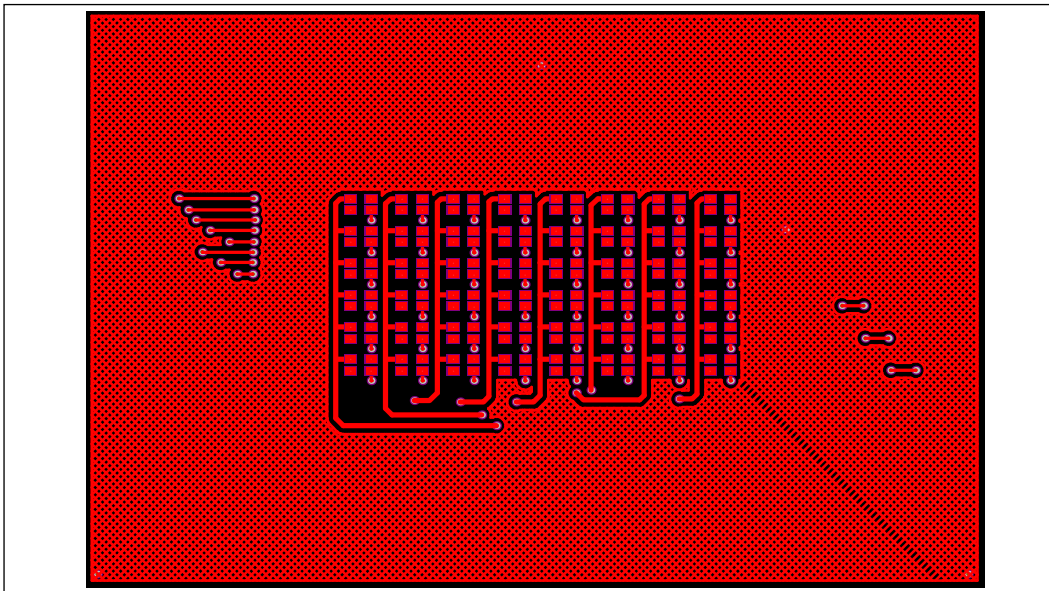

Figure 9: Board PCB Layout - Top Layer

18x8 DOTS MATRIX LED DRIVER EVALUATION BOARD GUIDE

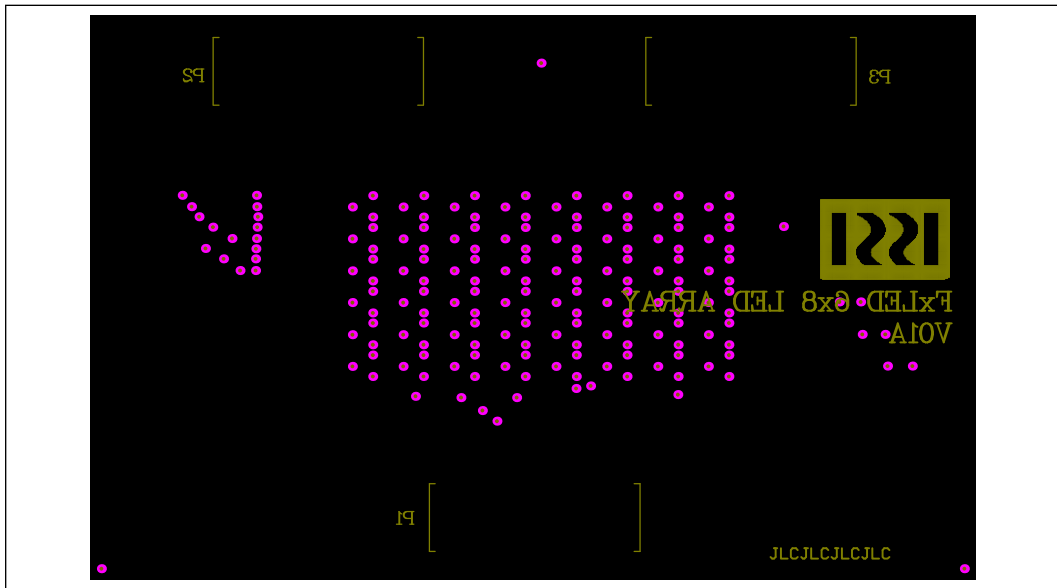

Figure 10: Board Component Placement Guide - Bottom Layer

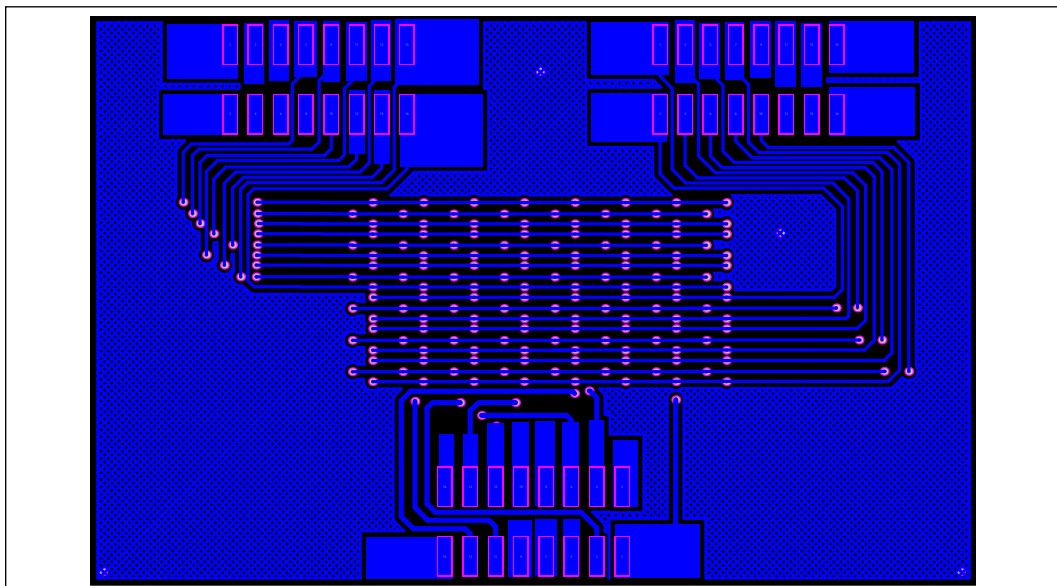

Figure 11: Board PCB Layout - Bottom Layer

Copyright © 2019 Lumissil Microsystems. All rights reserved. Lumissil Microsystems reserves the right to make changes to this specification and its products at any time without notice. Lumissil Microsystems assumes no liability arising out of the application or use of any information, products or services described herein. Customers are advised to obtain the latest version of this device specification before relying on any published information and before placing orders for products.

Lumissil Microsystems does not recommend the use of any of its products in life support applications where the failure or malfunction of the product can reasonably be expected to cause failure of the life support system or to significantly affect its safety or effectiveness. Products are not authorized for use in such applications unless Lumissil Microsystems receives written assurance to its satisfaction, that:

- a.) the risk of injury or damage has been minimized;
- b.) the user assume all such risks; and
- c.) potential liability of Lumissil Microsystems is adequately protected under the circumstances

18x8 DOTS MATRIX LED DRIVER EVALUATION BOARD GUIDE

REVISION HISTORY

| Revision | Detail Information | Data |
|----------|--------------------|------------|
| A | Initial Release | 2019.03.11 |

18x8 DOTS MATRIX LED DRIVER EVALUATION BOARD GUIDE

APPENDIX I : IS31FL3745 Arduino Test Code V01A

```
#include<Wire.h>
#include<avr/pgmspace.h>

#define Addr_GND_GND 0x40

void setup() {
  // put your setup code here, to run once:
  pinMode(13, OUTPUT);//ARDUINO BOARD LED control
  Wire.begin();
  Wire.setClock(400000);//I2C 400kHz
}

byte PWM_Gamma64[64]=
{
  0x00,0x01,0x02,0x03,0x04,0x05,0x06,0x07,
  0x08,0x09,0x0b,0x0d,0x0f,0x11,0x13,0x16,
  0x1a,0x1c,0x1d,0x1f,0x22,0x25,0x28,0x2e,
  0x34,0x38,0x3c,0x40,0x44,0x48,0x4b,0x4f,
  0x55,0x5a,0x5f,0x64,0x69,0x6d,0x72,0x77,
  0x7d,0x80,0x88,0x8d,0x94,0x9a,0xa0,0xa7,
  0xac,0xb0,0xb9,0xbf,0xc6,0xcb,0xcf,0xd6,
  0xe1,0xe9,0xed,0xf1,0xf6,0xfa,0xfe,0xff
};

void IS_IIC_WriteByte(uint8_t Dev_Add,uint8_t Reg_Add,uint8_t Reg_Dat)//writing an LED register
{
  Wire.beginTransmission(Dev_Add/2);
  Wire.write(Reg_Add); // sends regaddress
  Wire.write(Reg_Dat); // sends regaddress
  Wire.endTransmission(); // stop transmitting
}

void loop() {
  // put your main code here, to run repeatedly:
  mainloop();
}

void Init3745(void)
{
  int i,j;
  IS_IIC_WriteByte(Addr_GND_GND,0xfe,0xc5);
  IS_IIC_WriteByte(Addr_GND_GND,0xfd,0x00);//page 0
  for(i=0;i<0x91;i++)
  {
    IS_IIC_WriteByte(Addr_GND_GND,i,0);//PWM
  }
  IS_IIC_WriteByte(Addr_GND_GND,0xfe,0xc5);
  IS_IIC_WriteByte(Addr_GND_GND,0xfd,0x01);//page 1
  for(i=1;i<0x91;i++)
  {
    IS_IIC_WriteByte(Addr_GND_GND,i,0xff);//scaling
  }

  IS_IIC_WriteByte(Addr_GND_GND,0xfe,0xc5);
  IS_IIC_WriteByte(Addr_GND_GND,0xfd,0x02);//page 2
  IS_IIC_WriteByte(Addr_GND_GND,0x02,0x70);
  IS_IIC_WriteByte(Addr_GND_GND,0x01,0xFF);//GCC
  IS_IIC_WriteByte(Addr_GND_GND,0x00,0x01);//
}

void mainloop(void)//
{
  int i,j;
  Init3745();
  digitalWrite(13, LOW); // turn the ARDUINO BOARD LED on (HIGH is the voltage level)
  while(1)
  {
    //BLUE
    digitalWrite(13, HIGH); // turn the ARDUINO BOARD LED on (HIGH is the voltage level)
    IS_IIC_WriteByte(Addr_GND_GND,0xfe,0xc5);
    IS_IIC_WriteByte(Addr_GND_GND,0xfd,0x00);//page 0
  }
}
```

18x8 DOTS MATRIX LED DRIVER EVALUATION BOARD GUIDE

```

for(j=0;j<64;j++)
{
  for(i=1;i<0x91;i=i+3)
  {
    IS_IIC_WriteByte(Addr_GND_GND,i,PWM_Gamma64[j]);//PWM}
  }
}
delay(500);

digitalWrite(13, LOW); // turn the ARDUINO BOARD LED OFF (HIGH is the voltage level)
IS_IIC_WriteByte(Addr_GND_GND,0xfe,0xc5);
IS_IIC_WriteByte(Addr_GND_GND,0xfd,0x00);//page 0
for(j=63;j>=0;j--)
{
  for(i=1;i<0x91;i=i+3)
  {
    IS_IIC_WriteByte(Addr_GND_GND,i,PWM_Gamma64[j]);//PWM}
  }
}
delay(500);

//GREEN
digitalWrite(13, HIGH); // turn the ARDUINO BOARD LED on (HIGH is the voltage level)
IS_IIC_WriteByte(Addr_GND_GND,0xfe,0xc5);
IS_IIC_WriteByte(Addr_GND_GND,0xfd,0x00);//page 0
for(j=0;j<64;j++)
{
  for(i=2;i<0x91;i=i+3)
  {
    IS_IIC_WriteByte(Addr_GND_GND,i,PWM_Gamma64[j]);//PWM}
  }
}
delay(500);

digitalWrite(13, LOW); // turn the ARDUINO BOARD LED OFF (HIGH is the voltage level)
IS_IIC_WriteByte(Addr_GND_GND,0xfe,0xc5);
IS_IIC_WriteByte(Addr_GND_GND,0xfd,0x00);//page 0
for(j=63;j>=0;j--)
{
  for(i=2;i<0x91;i=i+3)
  {
    IS_IIC_WriteByte(Addr_GND_GND,i,PWM_Gamma64[j]);//PWM}
  }
}
delay(500);

//RED
digitalWrite(13, HIGH); // turn the ARDUINO BOARD LED on (HIGH is the voltage level)
IS_IIC_WriteByte(Addr_GND_GND,0xfe,0xc5);
IS_IIC_WriteByte(Addr_GND_GND,0xfd,0x00);//page 0
for(j=0;j<64;j++)
{
  for(i=3;i<0x91;i=i+3)
  {
    IS_IIC_WriteByte(Addr_GND_GND,i,PWM_Gamma64[j]);//PWM}
  }
}
delay(500);

digitalWrite(13, LOW); // turn the ARDUINO BOARD LED OFF (HIGH is the voltage level)
IS_IIC_WriteByte(Addr_GND_GND,0xfe,0xc5);
IS_IIC_WriteByte(Addr_GND_GND,0xfd,0x00);//page 0
for(j=63;j>=0;j--)
{
  for(i=3;i<0x91;i=i+3)
  {
    IS_IIC_WriteByte(Addr_GND_GND,i,PWM_Gamma64[j]);//PWM}
  }
}
delay(500);

//WHITE
digitalWrite(13, HIGH); // turn the ARDUINO BOARD LED on (HIGH is the voltage level)
IS_IIC_WriteByte(Addr_GND_GND,0xfe,0xc5);

```

18x8 DOTS MATRIX LED DRIVER EVALUATION BOARD GUIDE

```
IS_IIC_WriteByte(Addr_GND_GND,0xfd,0x00);//page 0
for(j=0;j<64;j++)
{
  for(i=1;i<0x91;i++)
  {
    IS_IIC_WriteByte(Addr_GND_GND,i,PWM_Gamma64[j]);//PWM}
  }
}
delay(500);

digitalWrite(13, LOW); // turn the ARDUINO BOARD LED OFF (HIGH is the voltage level)
IS_IIC_WriteByte(Addr_GND_GND,0xfe,0xc5);
IS_IIC_WriteByte(Addr_GND_GND,0xfd,0x00);//page 0
for(j=63;j>=0;j--)
{
  for(i=1;i<0x91;i++)
  {
    IS_IIC_WriteByte(Addr_GND_GND,i,PWM_Gamma64[j]);//PWM}
  }
}
delay(500);
}
}
```