

Pentium II¹ Power Supply Design Specification

The new IRVRM2 offers the power supply designer a complete turnkey solution for DC/DC converters required to power Intel's new Pentium II¹ microprocessor. A synchronous buck regulator topology operating at 200kHz is employed and achieves excellent efficiency with very fast transient load response and tight output voltage regulation.

The new 20V low V_{th} HEXFET Power MOSFET D²Pak is used in the synchronous circuitry to reduce board temperature and assembly costs while improving circuit efficiency through reduced $R_{DS(on)}$. Complete performance characterization along with a detailed schematic, bill-of-materials, and PCB layout are offered to reduce the customer's design time and effort.

Purpose

This is a production-ready design. It has been thoroughly tested for performance against the Intel Pentium II¹ 233/266MHz power specification, and evaluated for manufacturability by a high volume manufacturer.

This design will not be manufactured by International Rectifier. Its purpose is to simplify the design and qualification process for our customers.

Web Site

This design may be downloaded in two formats at IR's web site (www.irf.com). One is PDF format for on screen viewing or printing, the other is in native format so that you may manufacture the design if desired.

Floppy Disk

The design is also available on floppy disk. As on our web site, the floppy version contains two formats, PDF and native format.

Demo Boards

Completed boards are available through your local IR sales office and distribution.

Support

E-mail Chris Davis at cdavis1@irf.com for support of this design.

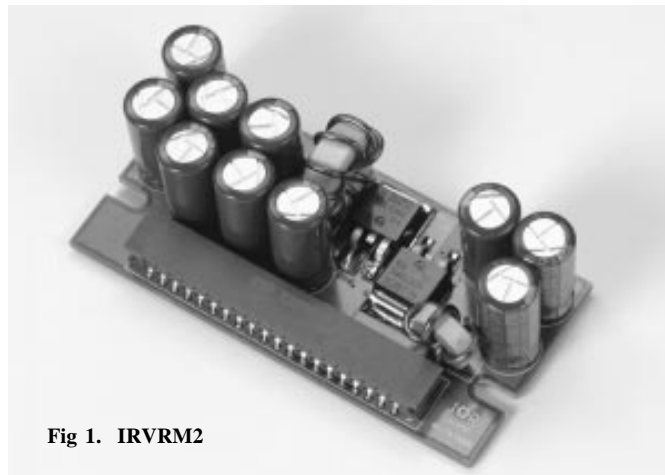

Fig 1. IRVRM2

Key Features

- Meets or exceeds all Intel 233/266MHz Pentium II¹ requirements
- 12.7A continuous output
- 1.8 to 3.5V digitally selectable output
- 30A/ μ S transient load response capability
- Short circuit protected
- Surface Mount MOSFETs eliminate heatsinks
- >80% Efficiency
- Design kit available: IRVRM2

Contents

Specifications	2
Schematic Diagram	3
Bill of Materials	4
Inductor Specifications	5
Assembly Options	5
Static Performance	6
Dynamic Performance	6

Copyright Restriction

This design may be used for production or evaluation purposes under the condition that all IR labeling and identification marks remain on all boards produced using this design, or as otherwise agreed to in writing by International Rectifier.

¹: A registered trademark of Intel Corporation

International IOR Rectifier Specifications

IRVRM2

Absolute Maximum Ratings (Table 1)

Parameter	Min	Max	Units	Conditions / Description
5 volt input	-	6.0	V	
12 volt input	-	13.0	V	
Continuous output current	-	12.7	A	Pulse width > 100ms
Ambient Temperature	10	60	°C	

Electrical Input Specifications

Parameter	Min	Typ	Max	Units	Conditions / Description
5 volt input (5Vin)	4.75	5.0	5.25	V	Supply meet all output specifications
5 volt input current	-	-	10	A	All line and load conditions
12 volt input (12Vin)	11.4	12.0	13.0	V	Supply meet all output specifications
12 volt input current	-	40	60	mA	All line and load conditions

Power Output Specifications (all specified line and load conditions)

Parameter	Min	Typ	Max	Units	Conditions / Description
Voltage Range	1.8	2.8	3.5	V	Selected by VID[0:4]
Current	0	7.6	12.7	A	
Static Voltage regulation	-2.1	-	+3.6	%	Of nominal VID set point.
Transient Voltage	-5	-	+5	%	30A/μs transitions 0.8A-to-12.7A @ 2.8V output
Ripple voltage	-1	-	+1	%	Percent of nominal
Turn on settling time	-	3.1	10	mS	Within ±10% of VID set point

Digital Input / Output Specifications

Signal	Input / Output	Conditions / Description
PWRGD	output	Open collector output. Logic 1 output signifies that the voltage output of the module is within ±12% of the selected level
OUTEN	input	Open collector input. Logic 0 disables the module output.
VID[0:4]	input	Open collector input. Selects nominal output voltage as shown in table #2.

Output Fault Protection

Parameter	Min	Typ	Max	Units	Conditions / Description
Short circuit protection	13	15.25	17.5	A	Output current during short circuit or overload
Over voltage protection	+10	-	+25	%	Shuts down the power supply when the output voltage exceeds 10%-to-25% above the set point

VID CODES (Table 2)

Vccp	VID 4	VID 3	VID 2	VID 1	VID 0
1.8V	0	0	1	0	1
1.85V	0	0	1	0	0
1.9V	0	0	0	1	1
1.95V	0	0	0	1	0
2.0V	0	0	0	0	1
2.05V	0	0	0	0	0
No CPU	1	1	1	1	1
2.1V	1	1	1	1	0
2.2V	1	1	1	0	1
2.3V	1	1	1	0	0
2.4V	1	1	0	1	1
2.5V	1	1	0	1	0
2.6V	1	1	0	0	1
2.7V	1	1	0	0	0
2.8V	1	0	1	1	1
2.9V	1	0	1	1	0
3.0V	1	0	1	0	1
3.1V	1	0	1	0	0
3.2V	1	0	0	1	1
3.3V	1	0	0	1	0
3.4V	1	0	0	0	1
3.5V	1	0	0	0	0

Fig 2. Connector pin out

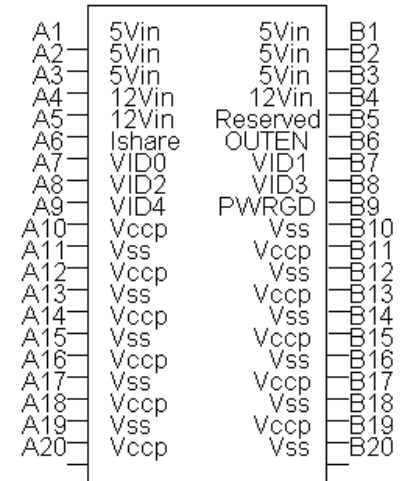

Fig 3. Silkscreen top view

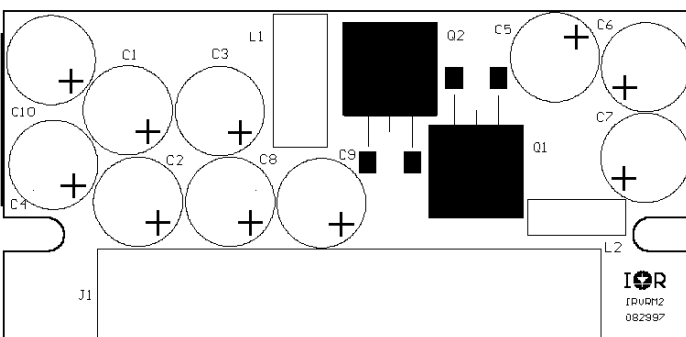
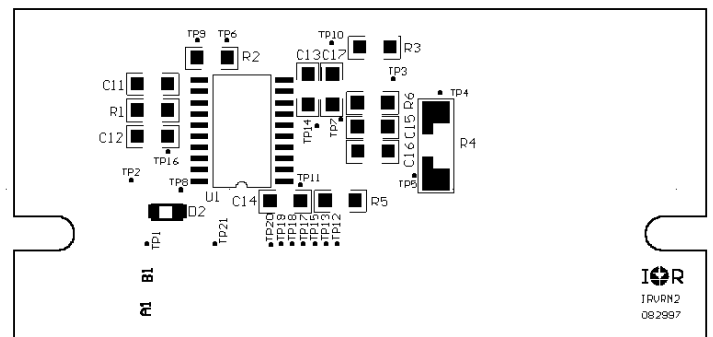
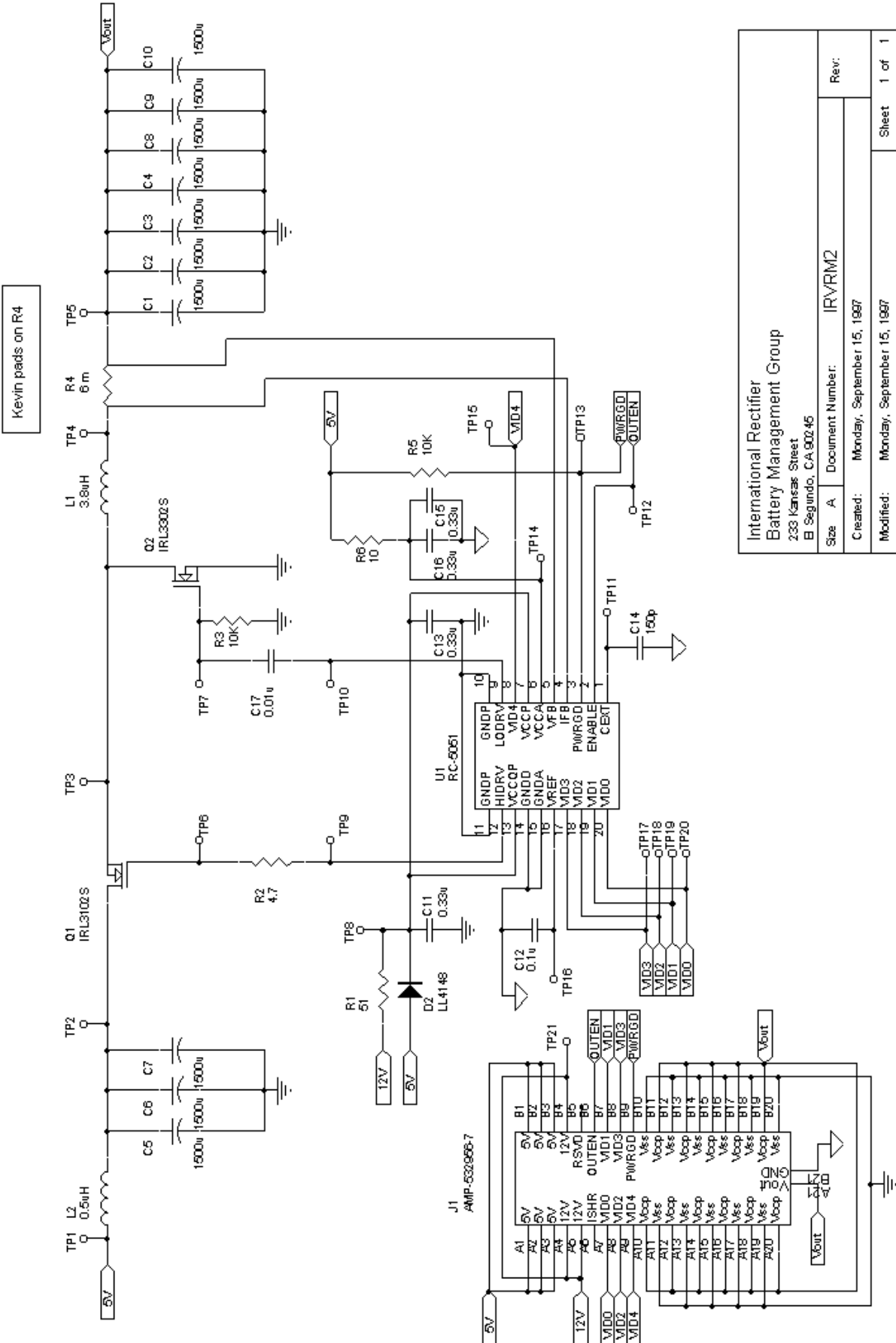

Fig 4. Silkscreen bottom view



Schematic Diagram

Fig 5.



International Rectifier Battery Management Group 233 Kansas Street El Segundo, CA 90245	
Size A	Document Number: IRVRM2
Created: Monday, September 15, 1997	Rev:
Modified: Monday, September 15, 1997	Sheet 1 of 1

Bill of Materials

(Table #3)

IRVRM2



Item	Qty	Part Type	Designator	Descr.	Man	Man PN	Vend.	Vend PN
1	1	0.01u	C17	50V cer cap 1206 Z5U	ROHM	MCH315E103ZK	Garrett	MCH315E103ZK
2	1	0.1u	C12	16V Z5U 20% 1206 Cap.	Capacitor Specialists	SMC1206Z5U104M016NT	NTD Electronics	SMC1206Z5U104M016NT
3	4	0.33u	C15 C11 C16 C13	20% 1206 Z5U capacitor	Novacap	1206Z334M500N	Garrett	1206Z334M500N
4	1	0.5uH	L2	4t of 15g on Micrometals T44-52 core	Pacific Transformer	IR002	Pacific Transformer	IR002
5	1	10	R6	5% 1206 Resistor	Panasonic	ERJ-8GEYJ100V	Digi-Key	P10ETR-ND
6	2	10K	R3 R5	1206 5% 1/8 watt surface mount	Panasonic	ERJ-8GEYJ103V	Digi-Key	P10KETR-ND
7	10	1500u	C1 C8 C7 C9 C10 C2 C5 C6 C4 C3	Radial lead electrolytic capacitor	Sanyo	6MV1500GX	Sanyo	6MV1500GX
8	1	150p	C14	5% NPO 50V ceramic Chip Cap.	MMC	CE151J3NO	Garrett	CE151J3NO
9	1	3.8uH	L1	9t of 16g on Micrometals T60-52 core	Pacific Transformer	IR001	Pacific Transformer	IR001
10	1	4.7	R2	5% 1206 Resistor	Panasonic	ERJ-8RQJ4R7	Digi-Key	P4R7PTR-ND
11	1	51	R1	5% 1/8 watt surface mount	Panasonic	ERJ-8GEYJ510V	Digi-Key	P51ETR-ND
12	1	6m	R4	1% 2225 1W	Dale Elec.	W5L-2512	Newark Elec.	W5L-2512
13	1	AMP-532956-7	J1	40 Pin connector	AMP	532956-7	Marshall Elec.	532956-7
14	1	IRL3102S	Q1	N-channel Low Vth MOSFET	IR	IRL3102S	IR	IRL3102S
15	1	IRL3302S	Q2	N-channel Low Vth MOSFET	IR	IRL3302S	IR	IRL3302S
16	1	LL4148	D2	high speed switching rectifier	Lite-on	LL4148	Digi-Key	LL4148TR-ND
17	1	RC-5051	U1	5 bit DAC Controller	Raytheon	RC5051	All American	RC5051

Manufacturers

International Rectifier -- (310) 322-3331
 Novacap----- (800) 227-2447
 Panasonic ----- (800) 922-0028
 Raytheon Electronics ----- (415) 968-9211
 Rohm ----- (408)433-2225
 MMC ----- (847) 577-0200
 AMP ----- (800) 522-6752
 Sanyo ----- (619) 661-6835
 Dale Electronics ----- (402) 563-6557

Distributors

Digi-Key ----- (800) 344-4539
 Garrett----- (800) 767-0081
 Newark Electronics ----- (800) 463-9275
 D.C. Electronics ----- (408)947-4510
 Marshall Electronics ----- (714) 842-3702
 All American ----- (818) 878-0533

Inductor Winding

Pacific Transformer ----- (714) 779-0450

Turn Key Manufacturing

Golden West Technology ----- (714)738-3775

Delivery

Items used in this design were found to have production quantity lead times of under 10 weeks. Most were well under 8 weeks.

PCB Fabrication

Teddeum ----- (909)946-4167

Inductor Specifications

Inductor Drawing

The specified inductors IR001 and IR002 can be purchased, assembled and tested (see BOM).

Fig 6. IR001

Core = Micrometals T60-52
Winding = 8 turns, 16 guage, single layer
Finished OD = 0.800" MAX
Finished Height = 0.4000" MAX
Lead Spacing = 0.3000" MAX +/- 0.05"
Leads extend 0.2" past OD, stripped and tinned 0.2"

3.8uH Nominal @ 0A DC
2.5uH Nominal @ 14A DC

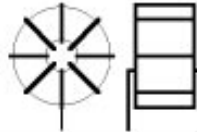

International Rectifier Battery Management Group 233 Kansas Street El Segundo, CA 90245		
Size A	Document Number: IR001	Rev:
Created:	Monday, September 15, 1997	
Modified:	Monday, September 15, 1997	Sheet 1 of 1

Fig 7. IR002

Core = Micrometals T44-52
Winding = 4 turns, 15 guage, single layer
Finished OD = 0.650" MAX
Finished Height = 0.3300" MAX
Lead Spacing = 0.2600" MAX +/- 0.05"
Leads extend 0.2" past OD, stripped and tinned 0.2"

0.56uH Nominal @ 0A DC
0.5uH Nominal @ 8.7A DC



International Rectifier Battery Management Group 233 Kansas Street El Segundo, CA 90245		
Size A	Document Number: IR002	Rev:
Created:	Monday, September 15, 1997	
Modified:	Monday, September 15, 1997	Sheet 1 of 1

Assembly Options

Q1 MOSFET Replacement

It would be very rare for any design to operate at 12.7A continuous output. All three MOSFET options given in Table 4 will operate at 12.7A continuous reliably. All three, however, will exceed the Intel recommended 115°C maximum junction temperature.

Table 4
Continuous current boundary @ $T_j \leq 115^\circ\text{C}$

	Q1	CURRENT
IRVRM2a	IRL3102S	11.92A
IRVRM2b	IRL3202S	11.66A
IRVRM2c	IRL3302S	11.48A

A more useful comparison is using the Intel specified typical current on a continuous basis, and adding higher current demand on a pulsed basis. Figure 8 shows typical waveforms and junction temperature excursions. For a given "t1" pulse width and "d" duty factor, there is an "I1" current which will cause Q1 to reach the Intel recommended 115°C maximum.

Fig 8. Typical load current and T_j waveform

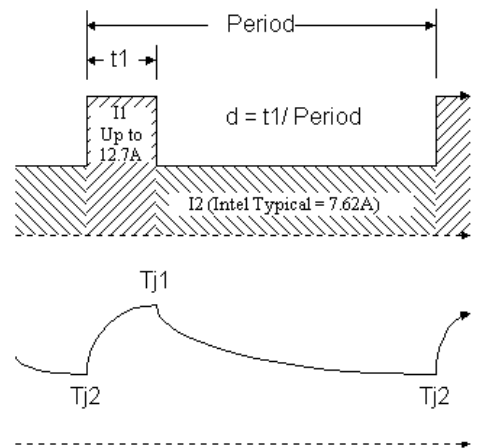

Performance using MOSFET replacement
Figures 9 thru 11 show that in most practical cases the less expensive IRL3302S would be the device of choice. Test conditions shown on Figure 8.

Fig 9.

I1 current boundary @ $T_j \leq 115^\circ\text{C}$ (IRL3302S)

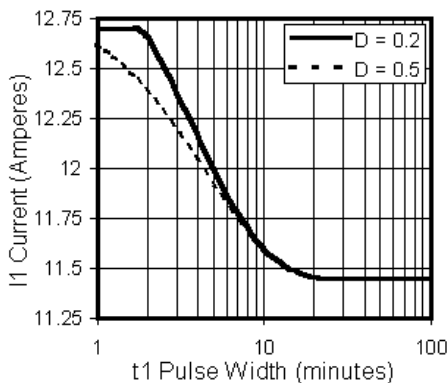

Fig 10.

I1 current boundary @ $T_j \leq 115^\circ\text{C}$ (IRL3202S)

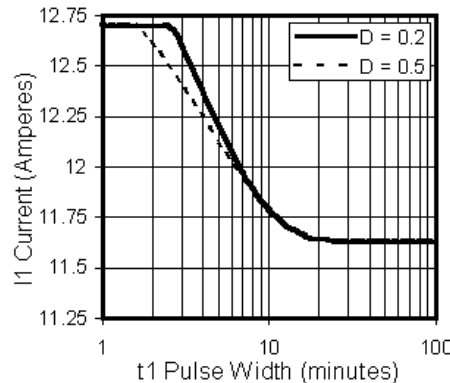
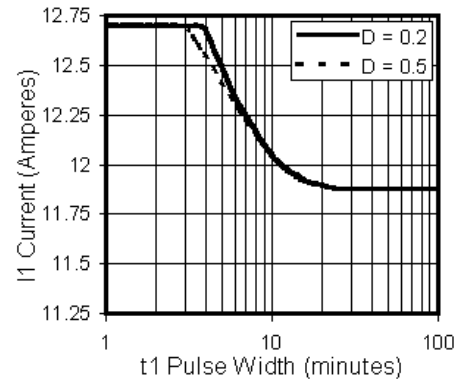

Fig 11.

I1 current boundary @ $T_j \leq 115^\circ\text{C}$ (IRL3102S)



Eliminate L2

Inductor L2 may be eliminated if your design does not require meeting the Intel recommended input di/dt specification, or if your design has additional external inductance. Figures 21, 22, 23, 25 shows the input di/dt both with and without L2.

Static Performance

Efficiency

Efficiency is required to be at least 80% at full load. Thanks to the very efficient 20V low V_{th} MOSFETs, IRVRM2 exceeds the required specification by a comfortable margin.

Fig 12. Typical Efficiency

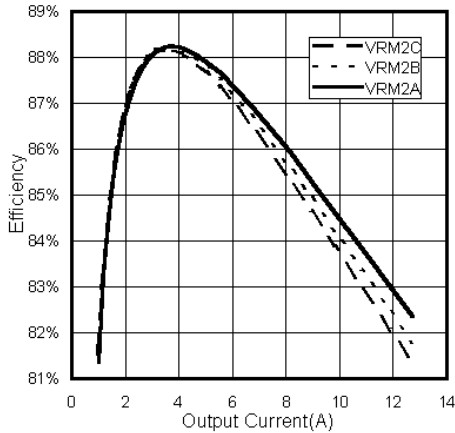
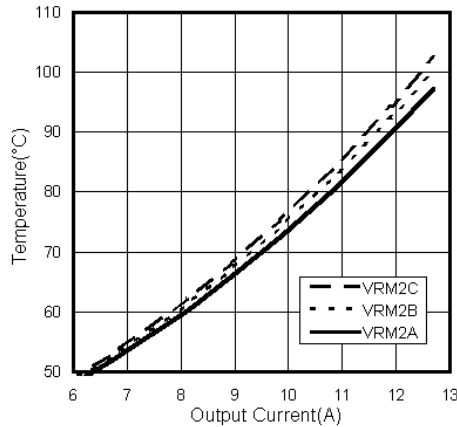

Fig 13. Typical T_j of Q1 $T_a = 25^\circ\text{C}$ (still air)



Maximum Junction Temperature

Analysis of Q1 junction temperature shows that it remains within specifications at an ambient temperature of 50°C , even in still air.

Fig 14. Projected T_j of Q1 $T_a = 50^\circ\text{C}$ (still air)

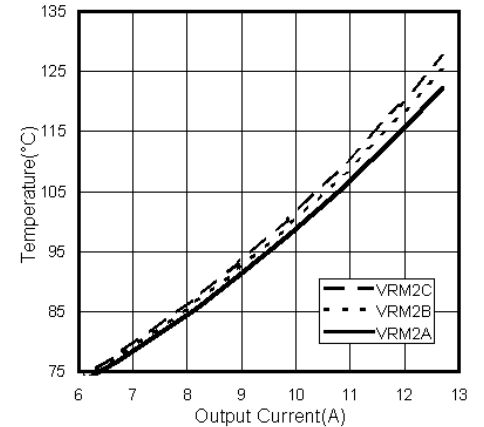
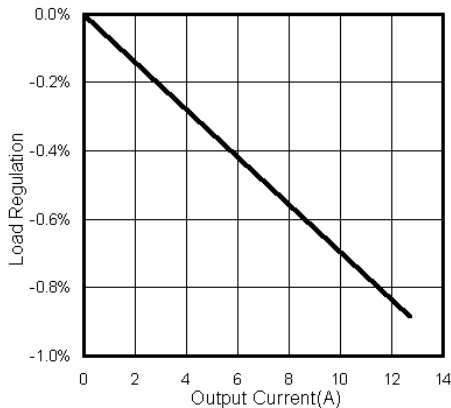

Fig 15. Typical Load Regulation



Load Regulation

The output must stay within its $-2.1\% \sim +3.6\%$ static specification from no load to full load.

Line Regulation

The Intel specification requires the line voltage to be within $\pm 5\%$ of nominal voltage. IRVRM2 easily meets line regulation specification even up to $\pm 10\%$.

Fig 16. Typical Line Regulation

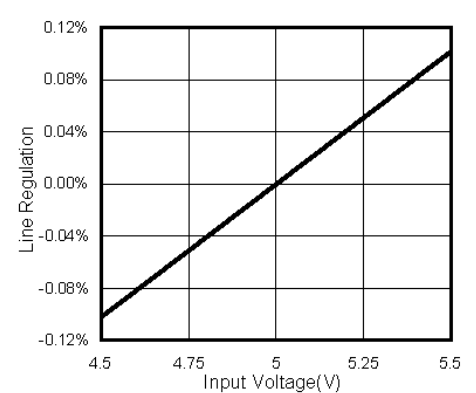

Dynamic Performance

Fig 17. Transient Load Current Rise Time

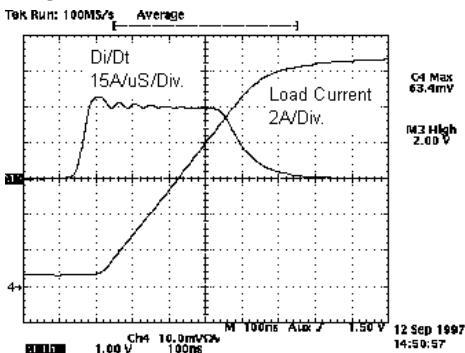

Transient Load Test Conditions

The Intel specification requires the supply to stay within its $\pm 5\%$ specification during transient load event of 0.8A-to-12.7A at a rate of $30\text{A}/\mu\text{s}$. Although most motherboards do not require this full level of performance, IRVRM2 meets the full transient response specification.

Fig 18. Transient Load Current Fall time

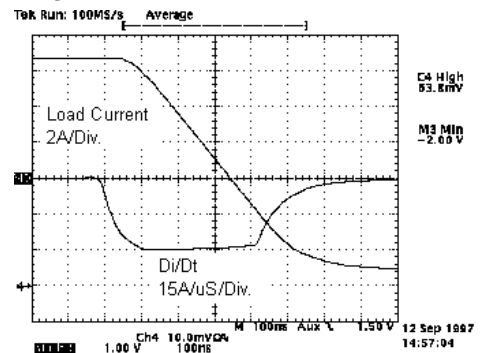

Dynamic Performance (continued)

Fig 19. 100 Hz Transient Output Voltage

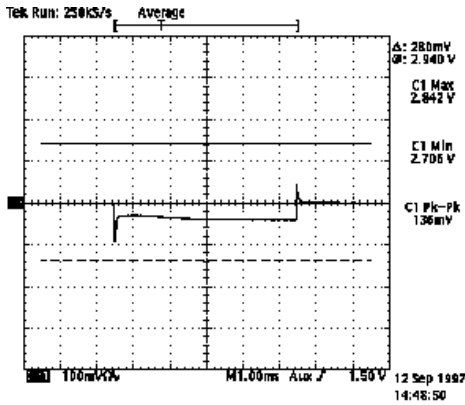

Transient Load At VRM2

Performance at 100kHz is dominated by stray output inductance and resistance. These are a combination of output capacitor ESL & ESR and board + connector inductance & resistance.

Performance at 100Hz exhibits the same rise & fall characteristics as at 100kHz. Setting the oscilloscope so as to see the whole waveform, however, reveals any undesirable loop characteristics. As shown, IRVRM2 is very well behaved at both 100Hz and 100kHz.

Fig 20. 100 kHz Transient Output Voltage

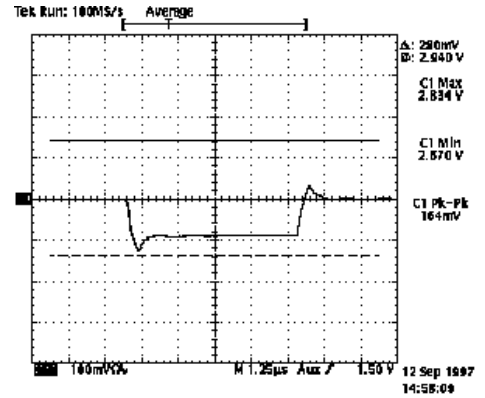

	Limit	100Hz	100kHz
Min	2.66V	2.706	2.670
Max	2.94V	2.842	2.834

Fig 21. Rising Input Current Waveform

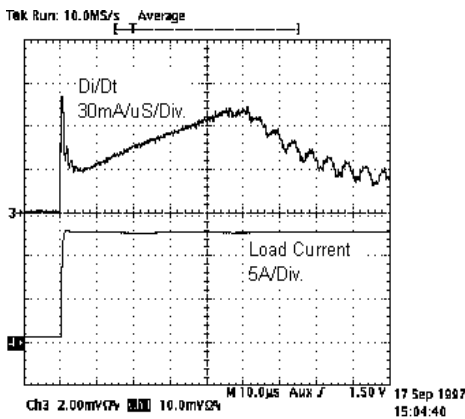

Input di/dt During Transient Load

Intel's specification recommends a maximum input di/dt during transient load of 0.1A/µs. IRVRM2 readily meets this specification at rising and falling edges of input current.

Transient measurements were taken with 1µH of total line inductance between the input power supply and IRVRM2. This approximately simulates total path inductance from the silver box to the VRM board in a typical computer system. IRVRM2 has an input inductance of 0.5µH (L2) to limit input di/dt to the Intel recommended 0.1A/µs.

Fig 22. Falling Input Current Waveform

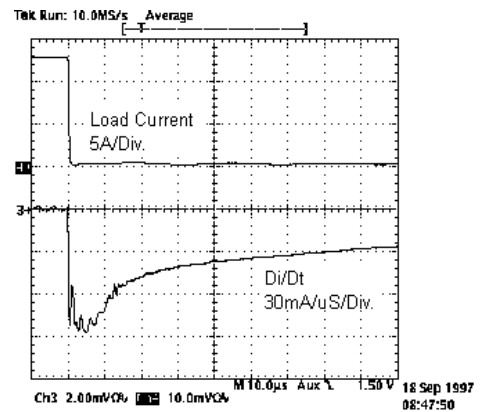

Fig 23. Rising Input current without L2

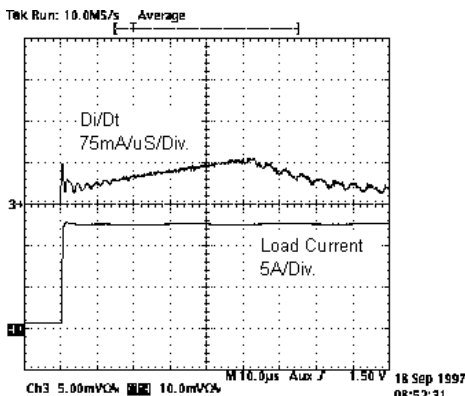
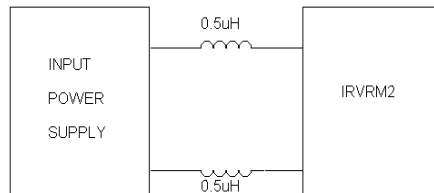
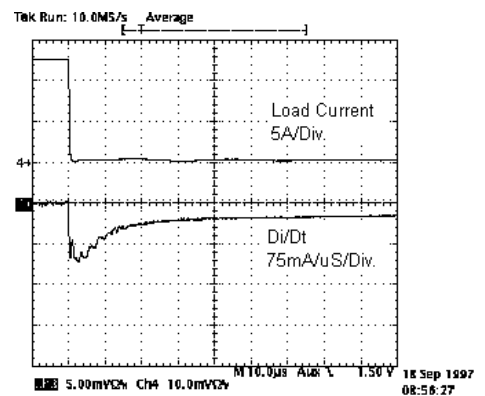

Fig 24. Input di/dt Test Circuit



	Limit	Rising	Falling
L2 = 0.5µH	.1A/µs	0.074	0.087
L2 = 0.0µH	.1A/µs	0.09	0.108

Fig 25. Falling Input Current without L2



Dynamic Performance (continued)

Fig 26. Output Voltage Ripple (No Load)

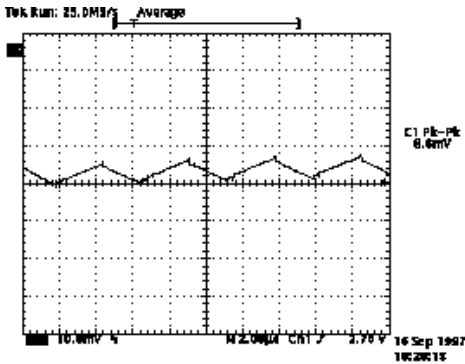

Output Ripple Voltage

Output ripple voltage is specified as a $\pm 1\%$ range, (56mV peak-to-peak) of the nominal output voltage.

Parameter	Limit	Measured
P-P ripple	56mV	15.2mV

Fig 27. Output Voltage Ripple (Full Load)

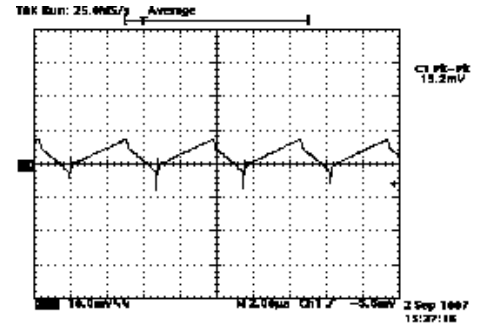
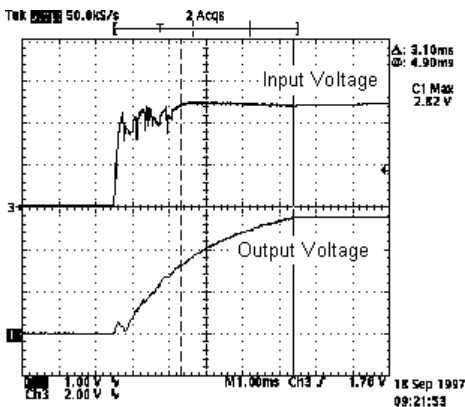

Fig 28. Turn on Waveform (Full Load)



Turn On Transient

Output voltage must remain within 10% of the nominal set point. Also, output voltage should reach its specified range, $-2.1\% \sim +3.6\%$, within 10ms after input voltage reaches 95% of nominal voltage.

Parameter	Limit	Measured
Risetime	10ms	3.1ms
Overshoot	3.08V	2.82V

Fig 29. Turn off Waveform (Full Load)

