

# IB IL AI 2-HART (-PAC)

## Inline Terminal With 2 Analog Input Channels and HART Functions

### AUTOMATION

Data Sheet  
6758\_en\_01

© PHOENIX CONTACT - 11/2007

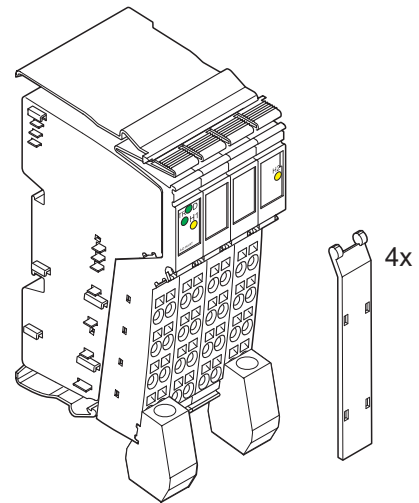

## 1 Function Description

The terminal is designed for use within an Inline station. It allows communication with smart field devices using the standardized communication protocols INTERBUS and HART. It provides both analog and digital communication. The analog signal transmits the process information. The modulated digital signal enables bidirectional communication to the sensor (with HART capabilities) at the same time.

### Features

- Two differential analog signal inputs to connect current signals
  - Sensors are connected using 2-wire technology (active and passive sensors)
  - Two differential analog signal inputs to connect current signals
  - Current measuring range: 4 mA ... 20 mA
  - By default, both channels are set to the measuring range 4 mA to 20 mA (IB IL format)
  - HART protocol transmission using PCP
- Hand-held connection possible
  - Measured values can be represented in three different formats
  - 16-bit analog/digital converter
  - Resolution depends on the representation format and the measuring range
  - Diagnostic indication
  - Point-to-point and multi-drop connections possible
  - Approved for the use in potentially explosive areas (observe the notes on page 7)



This data sheet is only valid in association with the IL SYS INST UM E user manual or the Inline system manual for your bus system.



A function block for easy terminal handling can be downloaded at [www.download.phoenixcontact.com](http://www.download.phoenixcontact.com).



Make sure you always use the latest documentation. It can be downloaded at [www.download.phoenixcontact.com](http://www.download.phoenixcontact.com).  
A conversion table is available on the Internet at [www.download.phoenixcontact.com/general/7000\\_en\\_00.pdf](http://www.download.phoenixcontact.com/general/7000_en_00.pdf).



This data sheet is valid for the products listed on the following page:

## 2 Table of Contents

1	Function Description .....	1
2	Table of Contents .....	2
3	Ordering Data .....	3
4	Technical Data.....	4
5	Local Diagnostic Indicators and Terminal Point Assignment.....	6
5.1	Local Diagnostic and Status Indicators.....	6
5.2	Function Identification .....	6
5.3	Terminal Point Assignment.....	6
6	Installation Instructions .....	6
7	Notes on Using the Terminal in Potentially Explosive Areas .....	7
8	Internal Circuit Diagram .....	8
9	Electrical Isolation.....	9
10	Connection Notes .....	9
10.1	Connection of the HART Devices For a Point-to-Point Connection .....	10
10.2	Connection of the HART Devices in a Multidrop Network.....	10
11	Programming Data/Configuration Data .....	11
12	Process Data .....	11
12.1	Assignment of the Terminal Points to the Input Data (See page 12) .....	11
12.2	Process Data Input Words (IN).....	12
13	Formats for the Representation of Measured Values.....	13
13.1	"IB IL" Format .....	13
13.2	"Standardized Representation" Format .....	13
13.3	"PIO" Format .....	14
13.4	Examples for Measured Value Representations.....	14
14	HART Functions of the IB IL AI 2-HART (-PAC) Terminal .....	15
14.1	Recommendations For Its Use .....	15
14.2	HART Communication.....	15
14.3	HART Operating Mode (Polling/Burst) for Point-to-Point Connections and Multidrop Networks .....	16
14.4	HART Device Addresses.....	17
15	Introduction Into FDT Technology.....	18
15.1	General Information About FDT/DTM.....	18
15.2	FDT and AutomationXplorer+.....	18
15.3	FDT and PC WorX.....	19
15.4	Internet .....	20
15.5	Documentation .....	20
15.6	Special Addressing and Connection (e.g., Using a Hand-Held Operating Device) .....	20

16 Reading Data Using the HART Protocol .....20

17 PCP Communication .....20

    17.1 Object Dictionary ..... 21

    17.2 UNIQUE\_IDENTIFIER\_CHANNEL1\_SLAVE1 ... 5 and  
        UNIQUE\_IDENTIFIER\_CHANNEL2\_SLAVE1 ... 5 Objects ..... 22

    17.3 HART\_PASS\_THROUGH\_CHANNEL1 / 2 Object..... 23

    17.4 POLL/BURST\_RESPONSE\_CHANNEL1\_SLAVE1 ... 5 and  
        POLL/BURST\_RESPONSE\_CHANNEL2\_SLAVE1 ... 5 Object ..... 25

    17.5 PROCESS\_DATA\_VALUE Object ..... 27

    17.6 STATUS Object..... 28

    17.7 CONTROL Object ..... 29

    17.8 INIT\_TABLE Object..... 30

18 Start Behavior .....32

### 3 Ordering Data

#### Products

Description	Type	Order No.	Pcs./Pkt.
Inline terminal with 2 analog input channels with HART functions; complete with accessories (connectors and labeling fields)	IB IL AI 2-HART-PAC	2861331	1
Inline Terminal with 2 analog input channels and HART functions; without accessories	IB IL AI 2-HART	2860264	1



The connectors listed below are needed for the complete fitting of the IB IL AI 2-HART terminal.

#### Accessories

Description	Type	Order No.	Pcs./Pkt.
Inline shield connector for analog Inline terminals	IB IL SCN-6 SHIELD	2726353	5
Connector for digital single-channel, two-channel or 8-channel Inline terminals	IB IL SCN-8	2726337	10

#### Documentation

Description	Type	Order No.	Pcs./Pkt.
"Automation Terminals of the Inline Product Range" user manual	IL SYS INST UM E	2698737	1
"Configuring and Installing the INTERBUS Inline Product Range" user manual	IB IL SYS PRO UM E	2743048	1
"INTERBUS Addressing" data sheet	DB GB IBS SYS ADDRESS	9000990	1
"Inline Terminals for Use in Zone 2 Potentially Explosive Areas" application note	AH EN IL EX ZONE 2	7217	1
"Peripherals Communication Protocol (PCP)" user manual	IBS SYS PCP G4 UM E	2745169	1
"Startup of a HART-Compatible Device in AutomationXplorer+" application note	AH EN AUTOMATIONXPLOERER & HART	7603	1

## 4 Technical Data

### General Data

Housing dimensions (width x height x depth)	48.8 mm x 120 mm x 71.5 mm
Weight	134 g (without connectors), 206 g (with connectors)
Operating mode	Process data operation with 2 words and PCP operation with 2 words
Transmission speed	500 kbps
Connection method for sensors	2-wire technology
Power supply of the sensors	24 V DC, provided by the terminal
Permissible temperature (operation)	-25°C ... +55°C
Permissible temperature (storage/transport)	-25°C ... +85°C
Permissible humidity (operation/storage/transport)	10 % ... 95% according to DIN EN 61131-2
Permissible air pressure (operation/storage/transport)	70 kPa ... 106 kPa (up to 3000 m above sea level)
Degree of protection	IP20
Class of protection	Class III, IEC 61140
Connection data for Inline connectors	
Connection type	Spring-cage terminals
Conductor cross-section	0.2 mm <sup>2</sup> ... 1.5 mm <sup>2</sup> (solid or stranded), 24 - 16 AWG

### Interface

Local bus	Data routing
-----------	--------------

### Supply of the Module Electronics and I/O Through the Bus Terminal/Power Terminal

Connection method	Potential routing
-------------------	-------------------

### Power Consumption

Communications power $U_L$	7.5 V
Current consumption from $U_L$	95 mA (typical), 110 mA (maximum)
I/O supply voltage $U_{ANA}$	24 V DC
Current consumption at $U_{ANA}$	50 mA (typical), 150 mA (maximum)
Total power consumption	1.9 W (typical)

### Analog Inputs

Number	2 differential analog inputs
Signals/resolution in the process data word (quantization)	
0 mA ... 25 mA (PIO format)	0.381 $\mu$ A/LSB
4 mA ... 20 mA (Standardized representation format)	1.000 $\mu$ A/LSB
4 mA ... 20 mA (IB IL format)	0.533 $\mu$ A/LSB
Measured value representation in the following formats:	
IB IL	15 bits with sign bit (see also page 13)
Standardized representation	15 bits with sign bit (see also page 13)
PIO	16 bits without sign bit (see also page 14)
Mean-value generation	Using 4, 16, 32 measured values, 16 measured values by default
Conversion time of the A/D converter	10 $\mu$ s, approximately

### Analog Input Stages of the Current Inputs

Input resistance	250 Ω (shunt)
Limit frequency (-3 dB) of the input filters	25 Hz
Process data update of both channels	Bus-synchronous
Behavior on sensor failure	Going to 0 mA or 4 mA
Maximum permissible voltage between analog current inputs and analog reference potential	±10 V (corresponds 40 mA across the sensor resistances)
Common mode rejection (CMR)	105 dB minimum
Reference: current input signal, valid for permissible DC common mode voltage range	115 dB (typical)
Permissible DC common mode voltage for CMR	40 V between current input and FE
Maximum permissible current	±40 mA

### Tolerance Behavior and Temperature Response of the Current Inputs (The error indications refer to the measuring range final value.)

T<sub>A</sub> = 23°C

Measuring Range	Absolute (Typical)	Absolute (Maximum)	Relative (Typical)	Relative (Maximum)
4 mA ... 20 mA	±10.0 µA	±50.0 µA	±0.05%	±0.25%
0 mA ... 25 mA	±10.0 µA	±50.0 µA	±0.04%	±0.20%

T<sub>A</sub> = -25°C ... +55°C

Measuring Range	Absolute (Typical)	Absolute (Maximum)	Relative (Typical)	Relative (Maximum)
4 mA ... 20 mA	±28.0 µA	±80.0 µA	±0.14%	±0.40%
0 mA ... 25 mA	±28.0 µA	±80.0 µA	±0.11%	±0.32%

### Additional Tolerances Influenced by Electromagnetic Fields

Type of Electromagnetic Interference	Typical Deviation of the Measuring Range Final Value (Current Input) Relative
Electromagnetic fields; Field strength 10 V/m According to EN 61000-4-3/IEC 61000-4-3	< ±2%
Conducted interference Class 3 (test voltage 10 V) According to EN 61000-4-6/IEC 61000-4-6	< ±1%
Fast transients (burst) 4 kV supply, 2 kV input According to EN 61000-4-4/IEC 61000-4-4	< ±1%

### Safety Equipment

Surge voltage	Suppressor diodes in the analog inputs
---------------	--

### Electrical Isolation/Isolation of the Voltage Areas

#### Common Potentials

24 V main power, 24 V segment voltage, and GND have the same potential. FE is a separate potential area.

#### Separate Potentials in the System Consisting of Bus Terminal/Power Terminal and an I/O Terminal

Test Distance	Test Voltage
5 V supply incoming remote bus/7.5 V supply (bus logic)	500 V AC, 50 Hz, 1 min
5 V supply outgoing remote bus/7.5 V supply (bus logic)	500 V AC, 50 Hz, 1 min
7.5 V supply (bus logic), 24 V supply U <sub>ANA</sub> / I/O	500 V AC, 50 Hz, 1 min
7.5 V supply (bus logic), 24 V supply U <sub>ANA</sub> / functional earth ground	500 V AC, 50 Hz, 1 min
I/O / functional earth ground	500 V AC, 50 Hz, 1 min

**Error Messages to the Higher-Level Control or Computer System**

Failure of the internal voltage supply	Yes
Peripheral fault/user error	Yes, error message via the IN process data (see page 12)

**Approvals**

For the latest approvals, please visit [www.download.phoenixcontact.com](http://www.download.phoenixcontact.com) or [www.eshop.phoenixcontact.com](http://www.eshop.phoenixcontact.com).

**5 Local Diagnostic Indicators and Terminal Point Assignment**

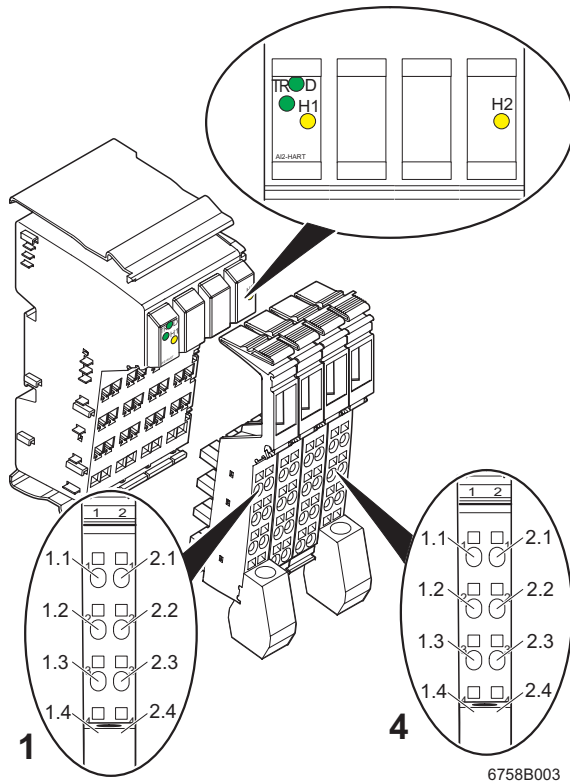

Figure 1 IB IL AI 2-HART terminal with appropriate connectors

**5.1 Local Diagnostic and Status Indicators**

Des.	Color	Meaning
D	Green	Diagnostics
TR	Green	PCP communication status
H <sub>1</sub> , H <sub>2</sub>	Yellow	HART communication status

**5.2 Function Identification**

Green

**5.3 Terminal Point Assignment**

Con-connectors	Terminal Points	Signal	Assignment
1	1.1	+24 V 1	Sensor supply channel 1
	1.2	+I1	Current input channel 1
	1.3	AGND1	Analog ground channel 1
	1.4, 2.4	FE	Shield connection
	2.2, 2.3	+I1	Hand-held operating device Connection channel 1
2 and 3	Not used		
4	1.1	+24 V 2	Sensor supply channel 2
	1.2	-I2	Current input channel 2
	1.3	AGND2	Analog ground channel 2
	1.4, 2.4	FE	Shield connection
	2.2, 2.3	+I2	Hand-held operating device Connection channel 2

**i** Observe the connection notes on page 9.

**6 Installation Instructions**

High current flowing through potential jumpers  $U_M$  and  $U_S$  leads to a temperature rise in the potential jumpers and inside the terminal. To keep the current flowing through the potential jumpers of the analog terminals as low as possible, always place the analog terminals after all the other terminals at the end of the main circuit (sequence of the Inline terminals: see also IL SYS INST UM E user manual or the Inline system manual for your bus system).

## 7 Notes on Using the Terminal in Potentially Explosive Areas

### Approval According to EC Directive 94/9 (ATEX)

 II 3G Ex nAC IIC T4 X

This Inline terminal conforms to the requirements of protection type "n" and can be installed in a zone 2 potentially explosive area. This Inline terminal is a category 3G item of electrical equipment.



**WARNING: Explosion hazard**  
**Only use Inline terminals that are approved for use in potentially explosive areas.**

Before using an Inline terminal in a zone 2 potentially explosive area, check that the terminal has been approved for installation in this area.

For a list of terminals approved for use in zone 2 potentially explosive areas, please refer to the AH EN IL EX ZONE 2 application note.

Check the labeling on the Inline terminal and the packaging (see Figure 2).



Potential routing 4 A maximum for use in Ex areas

IBx IL xx xx x

Order-No.: xxxxxxxx

Module-ID: xx HW/FW xxx-

PHOENIX CONTACT

INTERBUS



5561C001

Figure 2 Typical labeling of terminals for use in potentially explosive areas



**WARNING: Explosion hazard**

**Before startup, ensure that the following points and instructions are observed.**

1. When working on the Inline terminal, always disconnect the supply voltage.
2. The Inline terminal must only be installed, started up, and maintained by qualified specialist personnel.
3. Install the Inline terminals in a control cabinet or metal housing. The minimum requirement for both items is IP54 protection according to EN 60529.
4. The Inline terminal must not be subject to mechanical strain and thermal loads, which exceed the limits specified in the product documentation.
5. The Inline terminal must not be repaired by the user. Repairs may only be carried out by the manufacturer. The Inline terminal is to be replaced by an approved terminal of the same type.
6. Only category 3G equipment may be connected to Inline terminals in zone 2.
7. Observe all applicable standards and national safety and accident prevention regulations for installing and operating equipment.

### Restrictions



**WARNING: Explosion hazard**

When using terminals in potentially explosive areas, observe the technical data and limit values specified in the corresponding documentation (user manual, data sheet, package slip).



**WARNING: Explosion hazard**  
**Restrictions regarding the Inline system**

Please make sure that the **maximum permissible current of 4 A** flowing through potential jumpers  $U_M$  and  $U_S$  (total current) is not exceeded when using the Inline terminals in potentially explosive areas.



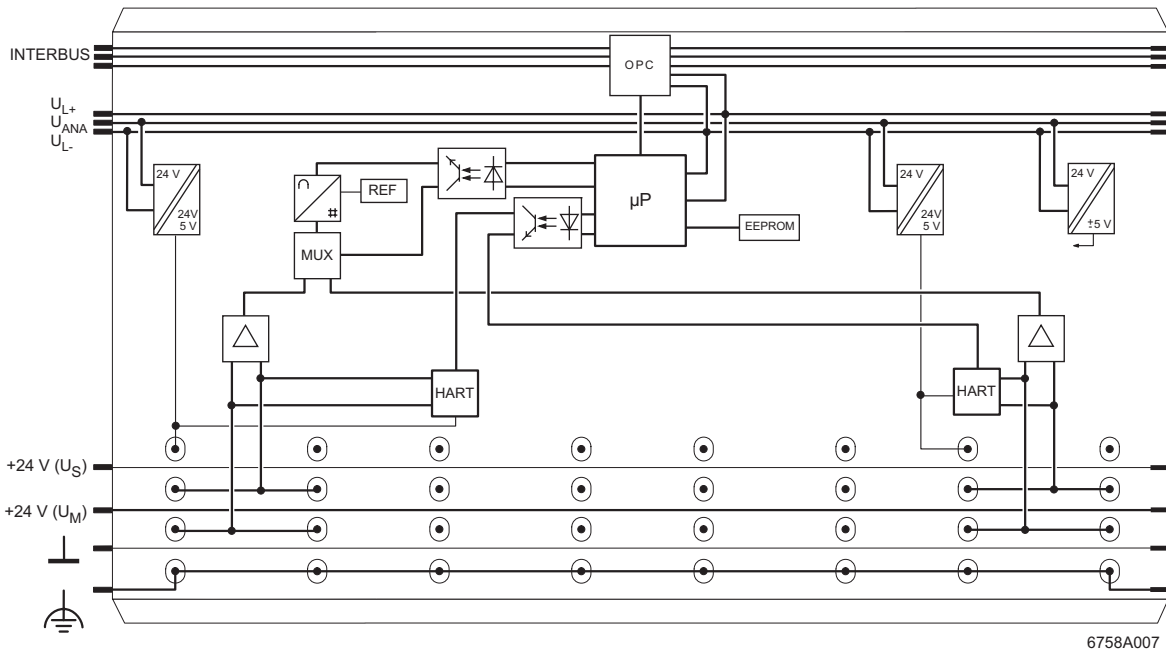







## 8 Internal Circuit Diagram



6758A007

Figure 3 Internal wiring of the terminal points

Key:

	Protocol chip		Microprocessor
	Supply unit with electrical isolation		Electrically erasable programmable read-only memory
	Analog/digital converter		Multiplexer
	Reference voltage		Amplifier
	Optocoupler		HART Modem



Other symbols used are explained in the IL SYS INST UM E user manual.



## 9 Electrical Isolation

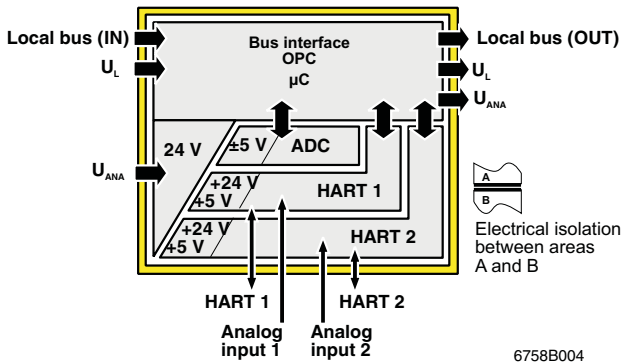

Figure 4 Electrical isolation of the individual function areas

6758B004

## 10 Connection Notes



### ATTENTION:

Do not connect voltages above  $\pm 10$  V to a current input. This damages the module electronics as the maximum permissible current of  $\pm 40$  mA is exceeded.

- Always connect analog sensors using shielded, twisted-pair cables.
- Connect the shielding to the terminal using the shield connection clamp. The clamp connects the shield to FE (functional earth ground) on the terminal side. Additional wiring is not necessary.
- Insulate the shielding at the sensor or connect it with a high resistance and a capacitor to the PE potential.
- Use a connector with shield connection when installing the sensors. Figure 5 and Figure 6 show the connection schematically (without a shield connection).

### Connection of the HART Devices

Please note that the connections of the HART field devices (slaves) to the Inline-HART terminal differs for point-to-point and multidrop connections (see 10.1 and 10.2).



The information can be found in Section "HART Operating Mode (Polling/Burst) for Point-to-Point Connections and Multidrop Networks" on page 16.

10.1 Connection of the HART Devices For a Point-to-Point Connection

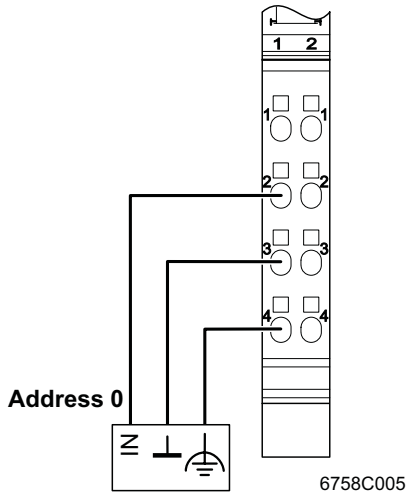

Figure 5 Connection of active sensors (slaves) in 2-wire technology with shield connection

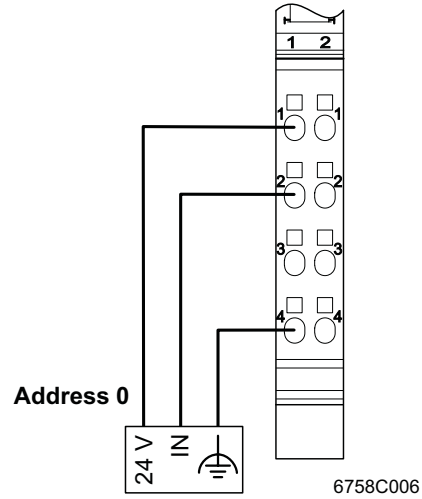

Figure 6 Connection of passive sensors (slaves) in 2-wire technology with shield connection (Loop power)

10.2 Connection of the HART Devices in a Multidrop Network

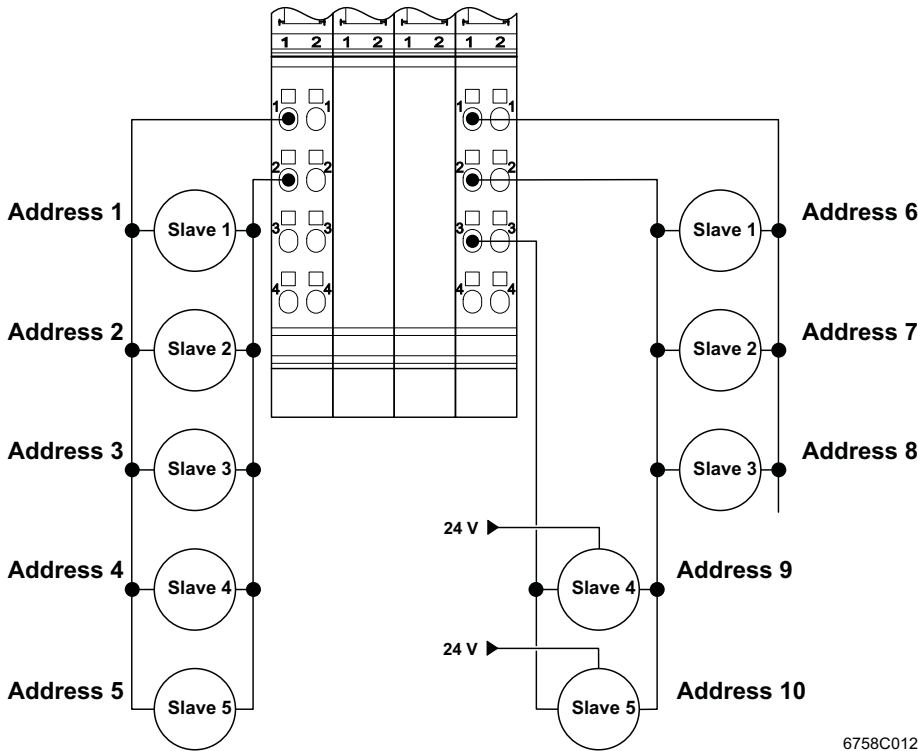

Figure 7 Connection of sensors (slaves) in a multidrop network

## 11 Programming Data/Configuration Data

### Local Bus (INTERBUS)

ID code	DC <sub>hex</sub> (220 <sub>dec</sub> )
Length code	02 <sub>hex</sub>
Input address area	2 words
Output address area	2 words
Parameter channel (PCP)	2 words
Register length (bus)	4 words

### Other Bus Systems



For the programming/configuration data of other bus systems, please refer to the corresponding electronic device data sheet (e.g., GSD, EDS).

## 12 Process Data



For the assignment of the illustrated (byte.bit) view to your **INTERBUS** control or computer system, please refer to the DB GB IBS SYS ADDRESS data sheet.

### 12.1 Assignment of the Terminal Points to the Input Data (See page 12)

(Word.bit) view	Word	Word 0															
	Bit	15	14	13	12	11	10	9	8	7	6	5	4	3	2	1	0
(Byte.bit) view	Byte	Byte 0								Byte 1							
	Bit	7	6	5	4	3	2	1	0	7	6	5	4	3	2	1	0
Channel 1 (connector 1)	Signal	Terminal point 1.2															
	Signal reference	Terminal point 1.3															
	Shield (FE)	Terminal point 1.4															
(Word.bit) view	Word	Word 1															
	Bit	15	14	13	12	11	10	9	8	7	6	5	4	3	2	1	0
(Byte.bit) view	Byte	Byte 0								Byte 1							
	Bit	7	6	5	4	3	2	1	0	7	6	5	4	3	2	1	0
Channel 2 (connector 4)	Signal	Terminal point 1.2															
	Signal reference	Terminal point 1.3															
	Shield (FE)	Terminal point 1.4															

12.2 Process Data Input Words (IN)

**i** Please observe that the content of the IN process data input words 1 and 2 is relevant for point-to-point connections only. In multidrop mode, a current value of 4 mA is indicated.

The measured value 1 (main measured value) is transmitted, per channel, to the controller board or the computer by means of the IN process data input words.

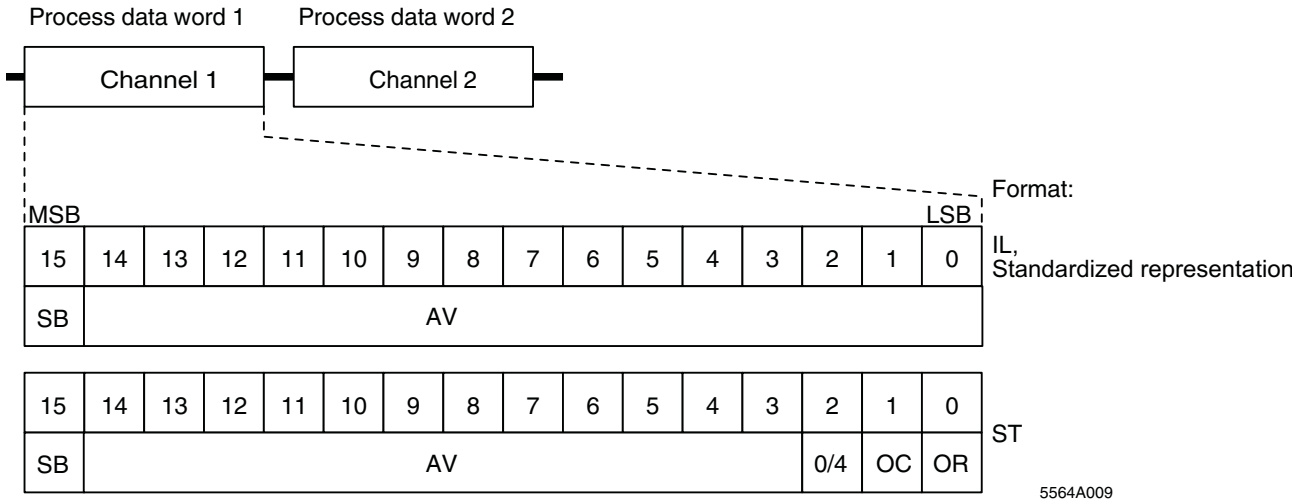

Figure 8 Sequence of the process input data words and display of the bits of the first process data word in the different formats

**Key**

- SB Sign bit
- AV Analog value
- MSB Most significant bit
- LSB Least significant bit

The "IB IL" and "standardized representation" process data formats support extended diagnostics.

The following error codes are possible:

Code (hex)	Error
8001	Overrange
8002	Open circuit
8004	Measured value invalid/ no valid measured value available
8010	Invalid configuration
8040	Terminal faulty
8020	Supply voltage not present

### 13 Formats for the Representation of Measured Values



Please note that the measured values shown are only relevant for a point-to-point connection. In multidrop mode a constant value is always displayed.

#### 13.1 "IB IL" Format

The "IB IL" format enables high-resolution representation of measured values in the 4 mA ... 20 mA measuring range.

The measured value is represented in bits 14 to 0. An additional bit (bit 15) is available as a sign bit.

This format supports extended diagnostics. Values  $>8000_{hex}$  and  $<8100_{hex}$  indicate an error. The error codes are listed on page 12.

Measured value representation in "IB IL" format (15 bits)

15	14	13	12	11	10	9	8	7	6	5	4	3	2	1	0
SB	AV														

SB Sign bit

AV Analog value

This format is the default format. To ensure that the terminal can be operated in previously used data formats, the measured value representation can be switched to other formats.

#### Significant Measured Values



Some codes are used for diagnostic functions. Therefore, the resolution is not 15 bits, but exactly calculated 14.9886847 bits.

Measuring range 4 mA ... 20 mA

Input Data Word (Two's Complement)		4 mA ... 20 mA $I_{Input}$ mA
hex	dec	
8001	Overrange	$> +21.339733$
7F00	32512	$+21.3397$
7530	30000	$+20.0$
0001	1	$+4.000533$
0000	0	$+4.0$ to $3.2$
8002	Open circuit	$< +3.2$

#### 13.2 "Standardized Representation" Format

The measured values are represented in bits 14 through 0. An additional bit (bit 15) is available as a sign bit. The overrange limits and the open circuit threshold in the higher-level control system can be freely defined.

In this format, data is standardized to the measuring range and represented in such a way that it indicates the corresponding value without conversion. In this format one bit has the value of 1  $\mu$ A.

This format supports extended diagnostics. Values  $>8000_{hex}$  and  $<8100_{hex}$  indicate an error. The error codes are listed on page 12.

Error messages occur according to the "IB IL" format. Open circuit and short-circuit limits can be set with the PCP object called INIT\_TABLE.

Measured value representation in "standardized representation" format (15 bits)

15	14	13	12	11	10	9	8	7	6	5	4	3	2	1	0
SB	AV														

SB Sign bit

AV Analog value

#### Significant Measured Values

Measuring range 4 mA ... 20 mA

Input Data Word (Two's Complement)		4 mA ... 20 mA $I_{Input}$ mA
hex	dec	
8001	Overrange	$> +22.5$ (default, value can be defined)
4E20	20000	$+20.0$
8002	Open circuit	$<3.2$ (default, value can be defined)

### 13.3 "PIO" Format

PIO format enables high-resolution representation of measured values in the 0 mA ... 25 mA current measuring range. In this format, the measuring range of 0 mA ... 25 mA is divided into  $2^{16}$  quantization steps (65 536 steps). Thus, unipolar measured currents with a resolution of 0.38  $\mu$ A/LSB can be represented. Signals between 0 mA ... 25 mA can be acquired.



Please note that error messages cannot be displayed in this format.

Measured value representation in "PIO" format (16 bits)

15	14	13	12	11	10	9	8	7	6	5	4	3	2	1	0
AV															

AV      Analog value

### Significant Measured Values

Measuring range 0 mA ... 25 mA

Input Data Word (Two's Complement)		PIO $I_{Input}$ mA
hex	dec	
F5C2	62914	+24.0
CCCD	52429	+20.0
6666	26214	+10.0
0A3D	2621	+1.0
0001	1	+0.3815 $\mu$ A
0000	0	+0

### 13.4 Examples for Measured Value Representations

Measured value representation in various data formats.

Measured value:                      10 mA

Process data input word

Format	hex Value	dec Value	Meas-ured Value	Measuring Range
IB IL	3A98	15 000	10 mA	4 mA ... 20 mA
PIO	6666	26 214	10 mA	0 mA ... 25 mA
Standardized representation	2710	10 000	10 mA	4 mA ... 20 mA

## 14 HART Functions of the IB IL AI 2-HART (-PAC) Terminal

### 14.1 Recommendations For Its Use

The following table contains notes on the use of the terminal depending on your requirements for the application:

Application	Recommendation
<ul style="list-style-type: none"> <li>- A HART slave</li> <li>- A measured value per HART slave</li> </ul>	<p>Please use the <b>process data input words</b> (see Section 12 on page 11). These process data input words contain a 16-bit measured signal value ranging from 4 mA ... 20 mA.</p>
<ul style="list-style-type: none"> <li>- A HART slave</li> <li>- Several measured values per HART slave</li> </ul>	<p>Use <b>polling mode</b> (see 14.3 on page 16). The terminal cyclically requests measured value from the HART slave using HART communication. These measured values are provided by the terminal. They can be read with a PCP service.</p>
<ul style="list-style-type: none"> <li>- A HART slave</li> <li>- Several measured values per HART slave</li> <li>- Fastest possible update of the measured value</li> </ul>	<p>Use <b>burst mode</b> (see Section 14.3 on page 16). The HART slave continuously sends measured values using HART communication. These measured values are provided by the terminal. They can be read with a PCP service.</p>
<ul style="list-style-type: none"> <li>- Several HART slaves</li> <li>- Each HART slave offers the same number of measured values</li> </ul>	<p>Use the <b>polling mode</b> (see 14.3 on page 16). The terminal cyclically requests measured values from each HART slave using HART communication. These measured values are provided by the terminal. They can be read with a PCP service.</p>
<ul style="list-style-type: none"> <li>- Unrestricted access to a HART slave</li> </ul>	<p>Use the <b>PASS_THROUGH</b> mechanism (see Section 17.3 on page 23) to directly communicate with each HART device using HART communication. Please note that the HART telegram needs to be imbedded into the PCP telegram.</p>

### 14.2 HART Communication

Data between masters and field devices is transmitted by superimposing an encoded digital signal on the 4 mA ... 20 mA current loop. Thanks to the encoding without mean value, simultaneous transmission of the analog signal is not affected.

In accordance with the HART specification, operating devices (masters) send a voltage signal. Field devices (slaves) send their messages via load-independent currents. The current signals are converted to voltage signals at the internal resistance (i.e., its load) of the receiver.

The signals are exchanged in accordance with the HART protocol specified by the HART foundation. In accordance with this master/slave procedure, the master initiates any communication activity. Slaves only start transmission upon request (see Figure 9).

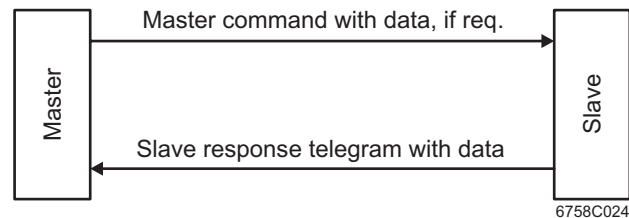

Figure 9 Exchanging HART commands



The HART specification allows for two masters, i.e. usually the HART operating device as primary master and a hand-held operator panel as secondary master.

The HART commands are transmitted as telegrams that are structured as follows:

**The HART Telegram Structure**

Preamble	SC	AD	HC	BC	ST	DA	CS
x	1 byte	5 bytes	1 byte	1 byte	2 bytes	xx	xxx

Key:

- Preamble:** The preamble is used to synchronize the HART devices.
- SC:** Start byte  
The start byte indicates the sender (master, slave, slave in burst mode) and whether a long or a short address is used.
- AD:** Address  
Length: 5 bytes = long address  
1 byte = short address  
  
Via this address the two masters are distinguished, burst telegrams and field devices are identified.
- HC:** HART command  
The HART command encodes the master's commands.
- BC:** Byte count = ST + DA  
This byte indicates the number of transmitted status and data bytes.
- ST:** Status  
The response message of a HART slave contains two status bytes. It indicates whether the data was received without errors (= 0) and the current field device status.
- DA:** Data  
The maximum data length is 26 bytes, depending on the HART command.
- CS:** Checksum of the entire telegram.

**Structure of the AD Address for Long Addresses:**

Long address (5 bytes)

Master	Burst	Bit 31, 30, 29, ...0
--------	-------	----------------------

Further information on the HART topic can be downloaded from the homepage of the HCF user organization (HART COMMUNICATION FOUNDATION) at [www.hartcomm.org](http://www.hartcomm.org)

The HART protocol can be implemented by any manufacturer and it can be freely used by any user. This open communication protocol between operating and field device is supported by the HART Communication Foundation (HCF). The HCF also provides technical support for the user. Among other things, the HCF monitors the openness of the protocol and manages device descriptions of all devices approved for operation.



HART and HCF logo

**14.3 HART Operating Mode (Polling/Burst) for Point-to-Point Connections and Multidrop Networks**

**Point-to-Point Connection (PTP)**

For a point-to-point connection, connect a HART field device (slave) to the HART operating device (master). The master communicates with precisely one HART device via one pair of wires. For this reason, the device address "0" must be set for the HART field device (cf. Figure 5 and Figure 6 on page 10).

**Multidrop Network**

In a multidrop network, the HART operating device communicates with up to 5 HART field devices being connected in parallel to the master via an individual wire pair each (cf. Figure 7). The device address of each slave determines which slave is addressed by the master. This device address is to be preset according to the range from 1 to 15. Please make sure

- NOT to set the device address "0" for slaves
- NOT to assign device addresses twice.

**Burst Mode Operation**

Burst mode operation is only possible for point-to-point connections. Here the slave is requested by the master to send a standard HART response telegram (burst telegram). This burst telegram is sent continuously by the HART slave until the master cancels the request.

The command number of the response is variable and is transmitted via the CONTROL object. This command number is sent to the HART slave via command 108. After this, burst mode operation is enabled via command 109.

The current response can be read via the POLL/BURST\_RESPONSE\_CHANNEL\_x\_SLAVE\_1 object.

In this operating mode a timeout is maintained: If no response telegram is received within 800 ms, the object length is set to 0.

When sending the burst command number or the burst enter command, the first status byte of the response is checked. If the HART device responds negatively to commands 108 or 109, the response is made available in



the POLL/BURST\_RESPONSE\_CHANNEL\_x\_SLAVE\_1 object and the 'Burst trouble' bit is set in the STATUS object. This can be the case when the HART slave does not support burst mode operation.

### Polling Mode Operation

In polling mode operation the Inline-HART terminal automatically sends HART commands to all HART slaves present at the same channel. Only HART commands 1, 2, and 3 are permitted. The current polling response can be read in the POLL\_RESPONSE\_CHANNEL\_x\_SLAVE\_x object.

If a slave sends a faulty HART response to the master, the corresponding slave is polled once again. A total of two polling trials are admissible. After the third faulty response, the object length is set to 0 and the next slave is polled.

### The HART Command Scope

The scope of possible HART commands depends on the HART field device used. For a list of commands supported by your HART field device, please refer to the device-specific documentation of the device manufacturer.

## 14.4 HART Device Addresses

### Setting the Device Address

There are several ways of setting the device addresses:

- Use the AutomationXplorer+ or PC WorX software offered by Phoenix Contact or
- Set the device addresses with a hand-held operating device (cf. Figure 10) or
- Contact the manufacturer of the HART field devices used.

The **default setting** of the device addresses of the field devices is always "0". Therefore the devices are preset to point-to-point operation.

For setting the device addresses of a HART field device connect a **hand-held operating device** to terminal points 2.2 and 2.3:

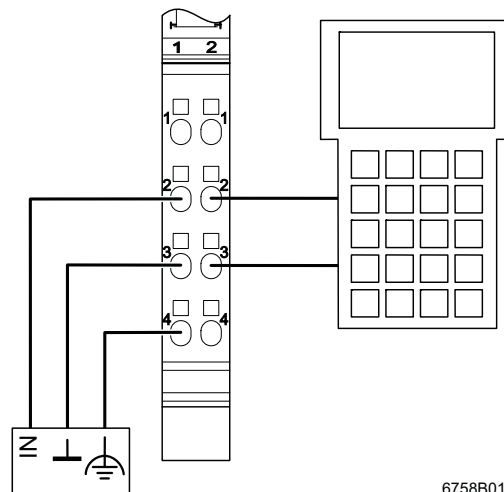

6758B013

Figure 10 Connecting a hand-held operating device for address modification

## 15 Introduction Into FDT Technology

### 15.1 General Information About FDT/DTM

FDT (Field Device Tool) is the name of the software specification that standardizes the fieldbus-independent configuration, parameterization, and diagnostics of devices in an automation network.

The device manufacturer provides device-specific drivers, the DTMs (Device Type Managers). The DTM of a device contains the device description and a device-specific user interface, for example. The DTM is used to integrate a device into the automation network using an FDT framework application (also known as FDT container software).

Phoenix Contact is a member of the FDT Group ([www.fdt-group.org](http://www.fdt-group.org)). Compatibility of the DTM provided by Phoenix Contact for the IB IL AI 2-HART Inline terminal with FDT specification 1.2 has been tested and certified.

### 15.2 FDT and AutomationXplorer+

The AutomationXplorer+ software is an FDT framework application, in which DTMs from various manufacturers can be integrated. Point-to-point communication, even beyond network boundaries, enables user-friendly parameterization and diagnostics of devices and sensors/actuators via, e.g., Ethernet, INTERBUS, Profibus, HART, and in future PROFINET IO or IO Link protocol.

Figure 11 shows on the left-hand side (Project Tree) the bus structure with the communication, gateway and device DTMs installed.

The DTM for the Inline-Profibus bus coupler is shown in the middle part. The Inline-Profibus bus coupler and the Inline station are configured and diagnosed in this part.

The DTM catalog is displayed on the right-hand side, sorted by device manufacturers as shown.

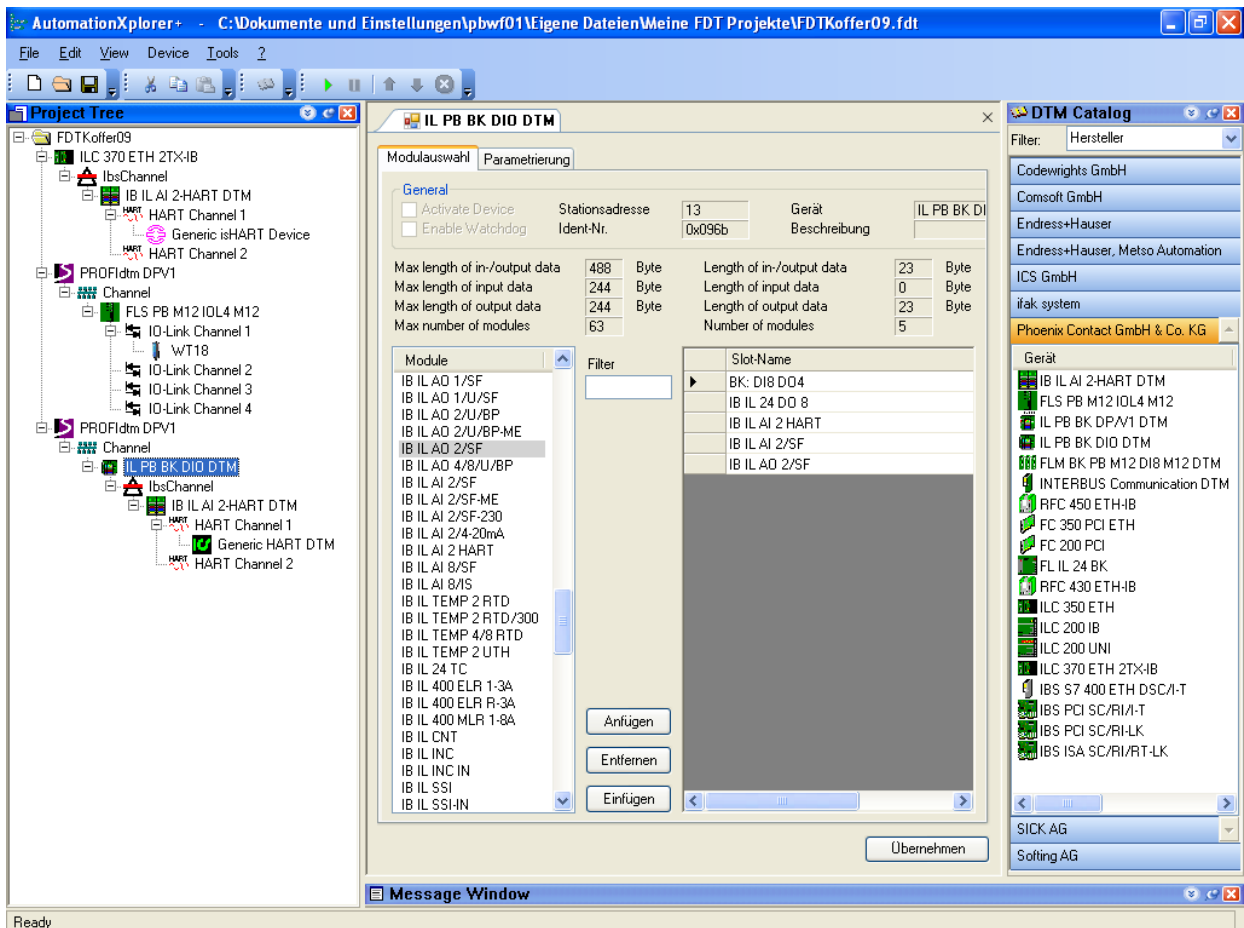

Figure 11 AutomationXplorer+

### 15.3 FDT and PC WorX

FDT function have been integrated into the PC WorX software, the standard IEC-61131 programming environment for control systems from Phoenix Contact. This allows to integrate DTMs from various manufacturers, and

to easily parameterize and diagnose devices and sensors/actuators, e.g. via Ethernet, INTERBUS, HART and PROFINET IO and in future even via the IO Link protocol.

The following figure shows the representation of a HART device in the PC WorX software.

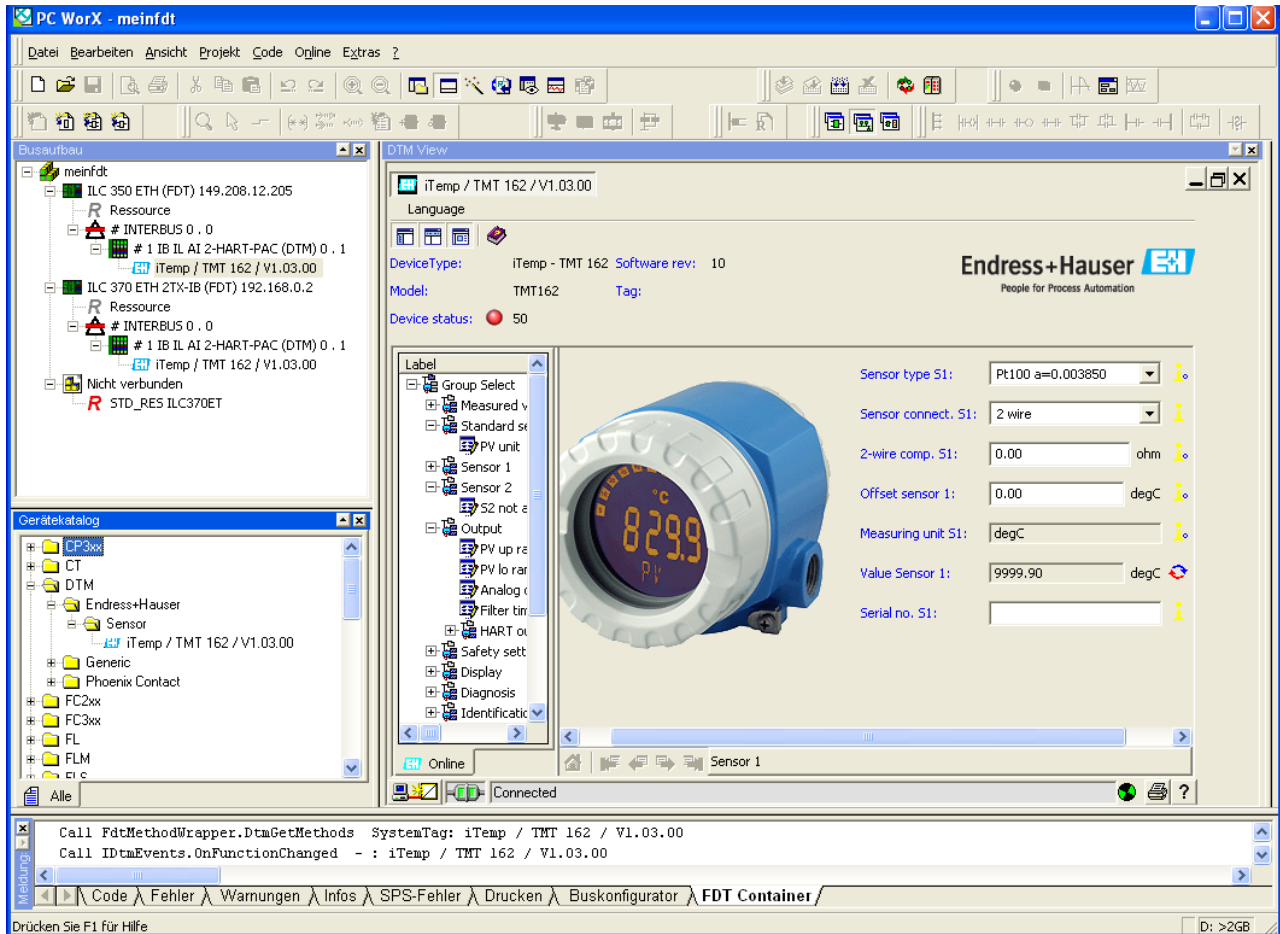

Figure 12 HARTdevice in PC WorX

## 15.4 Internet

AutomationXplorer+ can be downloaded at [www.automationexplorer.phoenixcontact.com](http://www.automationexplorer.phoenixcontact.com). Additional information about the software is also provided here.

Device-specific DTMs can be downloaded at [www.automationexplorer.phoenixcontact.com](http://www.automationexplorer.phoenixcontact.com) or [www.download.phoenixcontact.com](http://www.download.phoenixcontact.com).

For DTMs for devices from other manufacturers, please contact the relevant manufacturer.

## 15.5 Documentation

The "Startup of a HART-Compatible Device in AutomationXplorer+" application note uses an example to show how a HART-compatible device is handled in the AutomationXplorer+ software (see "Ordering Data" on page 3).

## 15.6 Special Addressing and Connection (e.g., Using a Hand-Held Operating Device)

In the PC WorX software, you do not need to program devices that you integrated into a bus structure using FDT/DTM technology. These devices only need to be configured.

## 16 Reading Data Using the HART Protocol

In point-to-point operating mode, the main value of the field devices is transmitted as an analog signal (4 mA ... 20 mA) using process data.

To read additional data you may use communications via the HART protocol. In the local bus and in the INTERBUS system, this protocol is implemented using PCP.

### When using a control system from Phoenix Contact and/or FDT communication:

For communications via the HART protocol you can use a function block that supports both, point-to-point as well as multidrop mode.

The function block can be downloaded at [www.download.phoenixcontact.com](http://www.download.phoenixcontact.com). It takes over PCP communication completely. You do not have to read Section 17 „PCP Communication“.

### When using other control systems:

Create a function block for communications via the HART protocol. Use the information on PCP communication in Section 17.

## 17 PCP Communication

You only need to read this section if you want to create your own function block for the use of HART communication (see also Section 16).



For further information on PCP communication, please refer to the IBS SYS PCP G4 UM E user manual.

Here you will also find more detailed information on error messages during PCP operation.

By default upon delivery, the terminal is configured for data transmission according to the parameters on page 30. You can configure the terminal to meet the requirements of your application.

The terminal is configured in PCP mode using the INIT\_TABLE object.



The programs IBS CMD and Config+ (for standard controller boards) as well as PC WorX (for Field Controllers (FC) and Remote Field Controllers (RFC) and embedded controllers (ILC 3xx)) are available for the configuration and parameterization of your INTERBUS system.

For more detailed information, please refer to the following user manuals: IBS CMD SWT G4 UM E, UM QS EN CONFIG+, and UM QS EN PC WORX.

## 17.1 Object Dictionary

Index	Data Type	N	L	Meaning	Object Name	Rights
0080 <sub>hex</sub>	String Var of Octet String	1	12		UNIQUE_IDENTIFIER_CHANNEL1_SLAVE1	rd
0081 <sub>hex</sub>	String Var of Octet String	1	12		UNIQUE_IDENTIFIER_CHANNEL1_SLAVE2	rd
0082 <sub>hex</sub>	String Var of Octet String	1	12		UNIQUE_IDENTIFIER_CHANNEL1_SLAVE3	rd
0083 <sub>hex</sub>	String Var of Octet String	1	12		UNIQUE_IDENTIFIER_CHANNEL1_SLAVE4	rd
0084 <sub>hex</sub>	String Var of Octet String	1	12		UNIQUE_IDENTIFIER_CHANNEL1_SLAVE5	rd
008F <sub>hex</sub>	String Var of Octet String	1	58		HART_PASS_THROUGH_CHANNEL1	rd/wr
0090 <sub>hex</sub>	String Var of Octet String	1	12		UNIQUE_IDENTIFIER_CHANNEL2_SLAVE1	rd
0091 <sub>hex</sub>	String Var of Octet String	1	12		UNIQUE_IDENTIFIER_CHANNEL2_SLAVE2	rd
0092 <sub>hex</sub>	String Var of Octet String	1	12		UNIQUE_IDENTIFIER_CHANNEL2_SLAVE3	rd
0093 <sub>hex</sub>	String Var of Octet String	1	12		UNIQUE_IDENTIFIER_CHANNEL2_SLAVE4	rd
0094 <sub>hex</sub>	String Var of Octet String	1	12		UNIQUE_IDENTIFIER_CHANNEL2_SLAVE5	rd
009F <sub>hex</sub>	String Var of Octet String	1	58		HART_PASS_THROUGH_CHANNEL2	rd/wr
00A0 <sub>hex</sub>	String Var of Octet String	1	40		POLL/ BURST_RESPONSE_CHANNEL1_SLAVE1	rd
00A1 <sub>hex</sub>	String Var of Octet String	1	40		POLL_RESPONSE_CHANNEL1_SLAVE2	rd
00A2 <sub>hex</sub>	String Var of Octet String	1	40		POLL_RESPONSE_CHANNEL1_SLAVE3	rd
00A3 <sub>hex</sub>	String Var of Octet String	1	40		POLL_RESPONSE_CHANNEL1_SLAVE4	rd
00A4 <sub>hex</sub>	String Var of Octet String	1	40		POLL_RESPONSE_CHANNEL1_SLAVE5	rd
00B0 <sub>hex</sub>	String Var of Octet String	1	40		POLL/ BURST_RESPONSE_CHANNEL2_SLAVE1	rd
00B1 <sub>hex</sub>	String Var of Octet String	1	40		POLL_RESPONSE_CHANNEL2_SLAVE2	rd
00B2 <sub>hex</sub>	String Var of Octet String	1	40		POLL_RESPONSE_CHANNEL2_SLAVE3	rd
00B3 <sub>hex</sub>	String Var of Octet String	1	40		POLL_RESPONSE_CHANNEL2_SLAVE4	rd
00B4 <sub>hex</sub>	String Var of Octet String	1	40		POLL_RESPONSE_CHANNEL2_SLAVE5	rd
00C0 <sub>hex</sub>	Array of Unsigned 16	2	2	Analog values	PROCESS_DATA_VALUE	rd
00C1 <sub>hex</sub>	Array of Unsigned 16	2	2		STATUS	rd
00C2 <sub>hex</sub>	Array of Unsigned 16	2	2	Settings (rescan, polling and burst mode)	CONTROL	rd/wr
00C3 <sub>hex</sub>	Array of Unsigned 16	14	2	Terminal configuration	INIT_TABLE	rd/wr

N: Number of elements

rd: Read access permitted

L: Element length in bytes

wr: Write access permitted

**17.2 UNIQUE\_IDENTIFIER\_CHANNEL1\_SLAVE1 ... 5 and  
UNIQUE\_IDENTIFIER\_CHANNEL2\_SLAVE1 ... 5 Objects**

The UNIQUE\_IDENTIFIER\_CHANNEL1/2\_SLAVE1 ... 5 objects contain the manufacturer's identification data of the slaves connected to the HART terminal.

**Object Description**

Objects	UNIQUE_IDENTIFIER_CHANNEL1_SLAVE1 ... 5 UNIQUE_IDENTIFIER_CHANNEL2_SLAVE1 ... 5
Access	Read
Data type	String Var of Octet String
Index	0080 <sub>hex</sub> - 0084 <sub>hex</sub> (Channel 1, Slave 1...5) 0090 <sub>hex</sub> - 0094 <sub>hex</sub> (Channel 2, Slave 1...5)
Subindex	00 <sub>hex</sub>
Length (bytes)	12 bytes
Data	Device identification

The objects with the indices 0080<sub>hex</sub>-0084<sub>hex</sub> and 0090<sub>hex</sub>-0094<sub>hex</sub> all have the same structure. For every possible HART slave there is a unique identifier object. All 008x<sub>hex</sub> indices are valid for channel 1, all 009x<sub>hex</sub> indices are valid for channel 2. With every object, the unique identifiers of the corresponding HART slaves can be read.

After power-up, these unique identifiers are read from the HART terminal to all present HART slaves. During this process, the "Scan Active" status bit is set.

**Byte Assignment of the UNIQUE\_IDENTIFIER\_CHANNELx\_SLAVE1 ... 5 Objects**

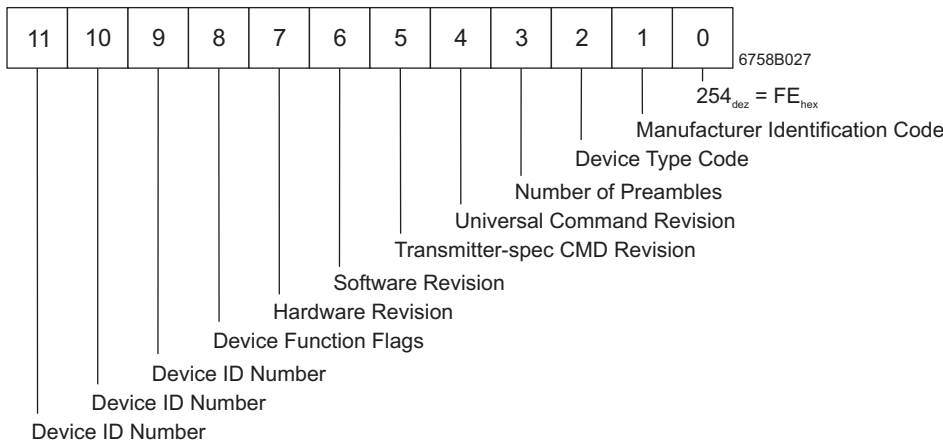

Figure 13 Byte assignment of the UNIQUE\_IDENTIFIER\_CHANNELx\_SLAVE1 ... 5 objects

**Error Message of This Object**

Parameters:

Error_Class	Error_Code	Additional_Code	Meaning
08 <sub>hex</sub>	00 <sub>hex</sub>	0021 <sub>hex</sub>	A Read service was received. The data is not yet available because the terminal still is in "Scan Active" mode.  Please wait until the "Scan Active" bit is set to 0 (see Figure 16 on page 28)

### 17.3 HART\_PASS\_THROUGH\_CHANNEL1 / 2 Object

The HART\_PASS\_THROUGH\_CHANNEL1 / 2 objects map the data of a PCP service to a HART telegram. In this way HART devices can receive HART telegrams directly.

#### Object Description

Object	HART_PASS_THROUGH_CHANNEL1 / 2 object
Access	Read, Write
Data type	String Var of Octet String
Index	008F <sub>hex</sub> (channel 1) / 009F <sub>hex</sub> (channel 2)
Subindex	00 <sub>hex</sub>
Length (bytes)	58 bytes, maximum
Data	Mapping the PCP user data to a HART telegram

#### Error Messages of This Object During Write Access

Parameters:

Error_Class	Error_Code	Additional_Code	Meaning
08 <sub>hex</sub>	00 <sub>hex</sub>	0020 <sub>hex</sub>	<ul style="list-style-type: none"> <li>– Polling or burst mode operation active</li> <li>– The message is to activate burst operating mode on a HART slave (command = 109 and data = 1)</li> </ul>
08 <sub>hex</sub>	00 <sub>hex</sub>	0022 <sub>hex</sub>	A second Write service was received, without the HART response having been collected by a Read service.
08 <sub>hex</sub>	00 <sub>hex</sub>	0024 <sub>hex</sub>	HART timeout, the addressed HART slave did not answer
08 <sub>hex</sub>	00 <sub>hex</sub>	0025 <sub>hex</sub>	HART communication error
06 <sub>hex</sub>	02 <sub>hex</sub>	0000 <sub>hex</sub>	HART supply voltage not present

The error message "(08, 00, 0022)<sub>hex</sub>" can be disabled in the INIT\_TABLE object. It ensures that a Write service to the HART\_PASS\_THROUGH\_CHANNELx object is always followed by a Read service.

In case, that two different applications use the HART\_PASS\_THROUGH\_CHANNELx object of the terminal, the service sequence is to prevent response telegrams being overwritten before they have been read. For example, it is to be prevented that application 2 generates a HART telegram the response telegram of which overwrites the response telegram of the HART telegram of application 1 before application 1 has read it.

There are two exceptions for which no error message is generated:

1. The preceding Write confirmation contains a negative result.
2. Between the first and the second Write service more than 30 seconds elapse.

The time of 30 seconds is to prevent the error message "(08, 00, 0022)<sub>hex</sub>" in the following case:

An application sends a Write service and crashes. After the restart it sends a Write service again.

If between these two Write services a time of 30 seconds elapsed, the application is processed without an error message.

There is a restriction with regard to the HART response transmission: The master address bit and the burst mode bit from the address field are always set to zero.

**Mapping the PCP User Data to a HART Telegram**

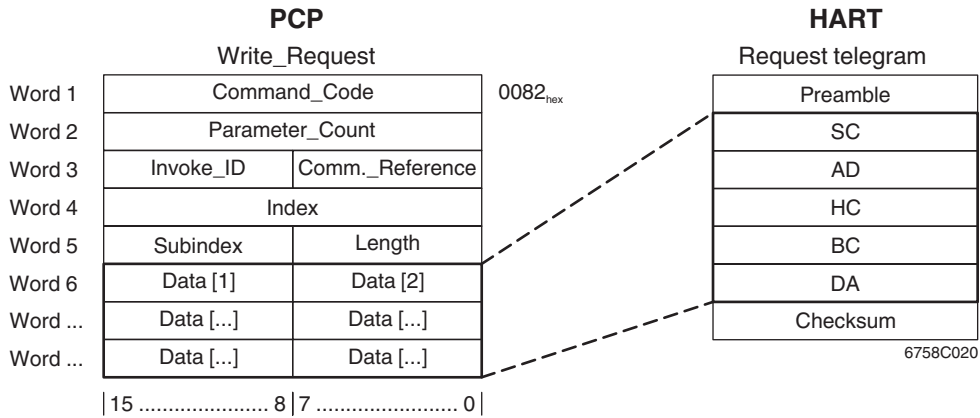

Figure 14 Mapping the PCP user data to a HART telegram

The user data of the PCP Write services are inserted between the preamble and the checksum of a HART request telegram. The start sign must be assigned because this sign contains the information whether the following address is short or long.

The same is valid for a HART response telegram. The data of a HART response telegram between preamble and checksum are made available as user data in the PCP read confirmation.

The PCP write confirmation is only sent back as soon as the HART response telegram was received by the Inline terminal. Usually this happens after 300 ms. Then the HART response telegram must be read via a PCP read request.

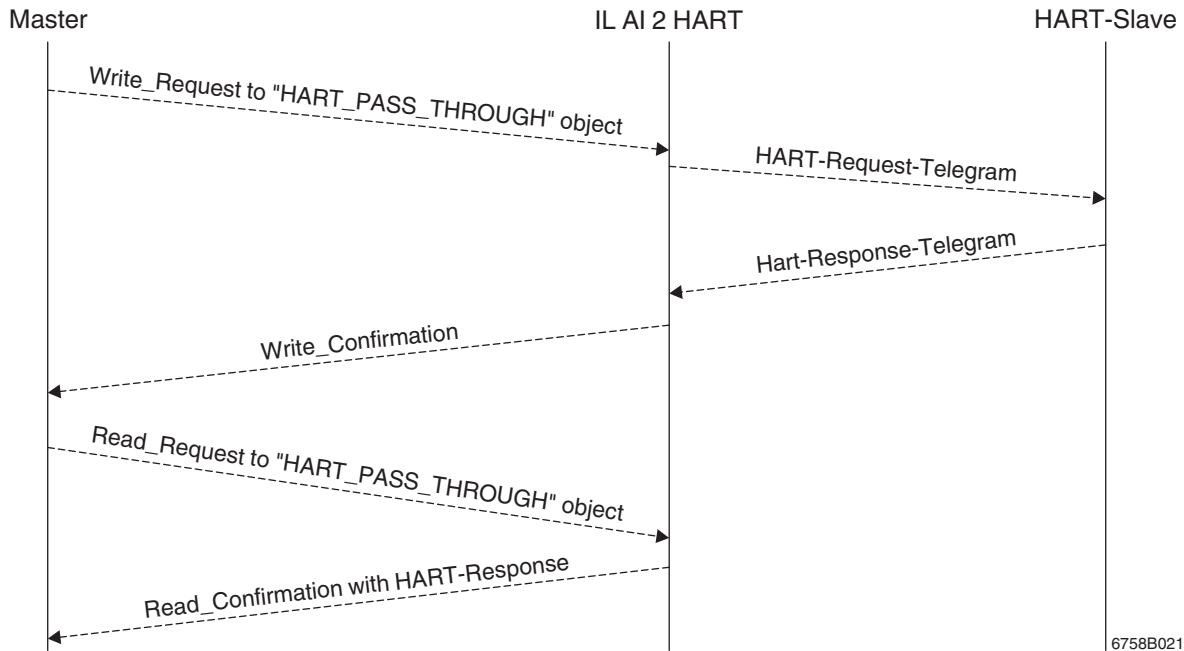

Figure 15 Service sequence between HART operating device (master) and HART field device (slave)



#### 17.4 POLL/BURST\_RESPONSE\_CHANNEL1\_SLAVE1 ... 5 and POLL/BURST\_RESPONSE\_CHANNEL2\_SLAVE1 ... 5 Object

The objects contain response telegrams of the HART devices that

- during polling mode operation responded to a request telegram by the master or
- are operated in burst mode.

##### Object Description

Object	POLL/BURST_RESPONSE_CHANNEL1_SLAVE1 ... 5 POLL/BURST_RESPONSE_CHANNEL2_SLAVE1 ... 5
Access	Read
Data type	String Var of Octet String
Index	00A0 <sub>hex</sub> - 00A4 <sub>hex</sub> (Channel 1, Slave 1...5) 00B0 <sub>hex</sub> - 00B4 <sub>hex</sub> (Channel 2, Slave 1...5)
Subindex	00 <sub>hex</sub>
Length (bytes)	40 bytes, maximum
Data	Measured data

The objects with the indices 00A0<sub>hex</sub>-00A4<sub>hex</sub> and 00B0<sub>hex</sub>-00B4<sub>hex</sub> all have the same structure. For every possible HART slave there is a response object. All 00Ax<sub>hex</sub> indices are valid for channel 1, all 00Bx<sub>hex</sub> indices are valid for channel 2. With every object, the unique identifiers of the corresponding HART slaves can be read. Since burst mode operation is only admissible for point-to-point connection, a burst response can only be read with index 00A0<sub>hex</sub> for channel 1 and index 00B0<sub>hex</sub> for channel 2.

The HART response to be read comprises the complete HART telegram format, however without preamble and checksum. In this way, the object has the same format as the PASS\_THROUGH object. For an example of a HART response, please refer to page 26.

##### Error Message of This Object

Parameters:

Error_Class	Error_Code	Additional_Code	Meaning
06 <sub>hex</sub>	02 <sub>hex</sub>	0030 <sub>hex</sub>	HART supply voltage not present Check the voltage supply of the Inline HART terminal.



Please observe that the measured data structure depends on the polling mode set. For further information, please refer to the HART command overview of the HART Communication Foundation HCF.

### Example of a HART Response

The following example only deals with the response telegram in polling mode operation. Here, only the 3 HART commands 1, 2 or 3 can be selected. The response telegram is structured according to the selected command. The data of a HART response telegram between preamble and checksum are made available as user data in the PCP read confirmation.

The object is read with a PCP read request. The content of a read confirmation depends on the selected HART command.

Structure of the PCP read confirmation:

	Byte	Meaning	Command 1	Command 2	Command 3
PCP header	1	Message code 1st byte	80	80	80
	2	Message code 2nd byte	81	81	81
	3	Parameter count 1st byte	00	00	00
	4	Parameter count 2nd byte	0B <sub>hex</sub> = 11 <sub>dec</sub>	0C <sub>hex</sub> = 12 <sub>dec</sub>	14 <sub>hex</sub> = 20 <sub>dec</sub>
	5	Invoke ID	xx	xx	xx
	6	Comm. reference	xx	xx	xx
	7	Result 1st byte	00	00	00
	8	Result 2nd byte	00	00	00
	9	Not used	--	--	--
	10	Length	0F <sub>hex</sub> = 15 <sub>dec</sub>	12 <sub>hex</sub> = 18 <sub>dec</sub>	22 <sub>hex</sub> = 34 <sub>dec</sub>
HART part	11	Start character	86 <sub>hex</sub>	86 <sub>hex</sub>	86 <sub>hex</sub>
	12	Address 1st byte	xx	xx	xx
	13	Address 2nd byte	xx	xx	xx
	14	Address 3rd byte	xx	xx	xx
	15	Address 4th byte	xx	xx	xx
	16	Address 5th byte	xx	xx	xx
	17	Command	01	02	03
	18	Byte count	07	A <sub>hex</sub> = 10 <sub>dec</sub>	1A <sub>hex</sub> = 26 <sub>dec</sub>
	19	Status 1st byte	00	00	00
	20	Status 2nd Byte	00	00	00
	21	Data	PV units code	Current 1st byte	Current 1st byte
	22	Data	PV 1st byte	Current 2nd byte	Current 2nd byte
	23	Data	PV 2nd byte	Current 3rd byte	Current 3rd byte
	24	Data	PV 3rd byte	Current 4th byte	Current 4th byte
	25	Data	PV 4th byte	Percent of range 1st byte	PV units code
	26	Data		Percent of range 2nd byte	PV 1st byte
	27	Data		Percent of range 3rd byte	PV 2nd byte
	28	Data		Percent of range 4th byte	PV 3rd byte
	29	Data			PV 4th byte
	30	Data			SV units code
	31 - 34	Data (4 bytes)			SV 1st to 4th byte
	35	Data			TV units code
36 - 39	Data (4 bytes)			TV 1st to 4th byte	
40	Data			FV units code	
41 - 44	Data (4 bytes)			FV 1st to 4th byte	

**17.5 PROCESS\_DATA\_VALUE Object**



This object is only relevant for a point-to-point connection.

This object provides measured values that are also contained in the IN process data (see Section 12.2 on page 12).

**Object Description**

Object	PROCESS DATA VALUE	
Access	Read	
Data type	Array of Unsigned 16	2 x 2 bytes
Index	00C0 <sub>hex</sub>	
Subindex	00 <sub>hex</sub> 01 <sub>hex</sub> 02 <sub>hex</sub>	Both channels Channel 1 Channel 2
Length (bytes)	For subindex 0, the length is 4 bytes. For subindex >0, the length is 2 bytes.	
Data	1st word for channel 1 2nd word for channel 2	



Please observe that the data read out with this object depends on the addressed HART field device.

### 17.6 STATUS Object

The STATUS object indicates the operating state of each channel of the terminal.

#### Object Description

Object	STATUS	
Access	Read	
Data type	Array of Unsigned 16 <span style="float: right;">2 x 2 bytes</span>	
Index	00C1 <sub>hex</sub>	
Subindex	00 <sub>hex</sub> 01 <sub>hex</sub> 02 <sub>hex</sub>	Both channels Channel 1 Channel 2
Length (bytes)	For subindex 0, the length is 4 bytes. For subindex >0, the length is 2 bytes.	
Data	1st word (element) for channel 1 2nd word (element) for channel 2	

#### Description of an Element/Bit Assignment

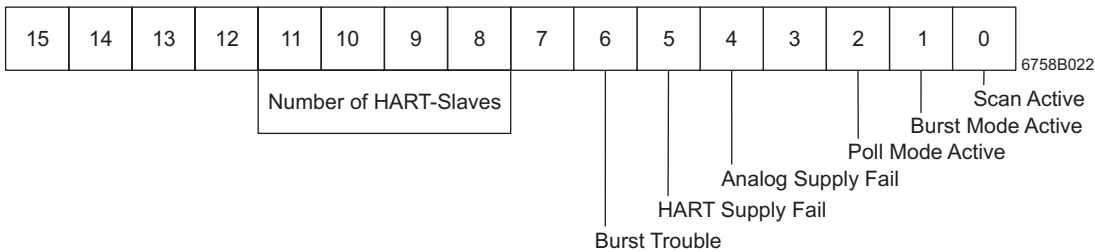

Figure 16 Assignment of an element of the STATUS object (00C1<sub>hex</sub>)

These two supply voltage error bits are reset after voltage is restored. If the Burst Trouble bit is set, you can set it via an error-free write access onto the CONTROL object.



- The polling modes can be selected depending on the HART field devices used.
- The data read out with this object depend on the addressed HART field device.

### 17.7 CONTROL Object

Set the polling mode or burst mode via this object for each channel of the terminal.

#### Object Description

Object	CONTROL	
Access	Read, Write	
Data type	Array of Unsigned 16 <span style="float: right;">2 x 2 bytes</span>	
Index	00C2 <sub>hex</sub>	
Subindex	00 <sub>hex</sub> 01 <sub>hex</sub> 02 <sub>hex</sub>	Both channels Channel 1 Channel 2
Length (bytes)	For subindex 0, the length is 4 bytes. For subindex >0, the length is 2 bytes.	
Data	1st word (element) for channel 1 2nd word (element) for channel 2	

#### Description of an Element/Bit Assignment

15	14	13	12	11	10	9	8	7	6	5	4	3	2	1	0
Re-Scan				Poll command 0: Polling mode not active 1, 2, 3 allowed				Burst command 0: Burst mode not active							

Figure 17 Assignment of an element of the CONTROL object (00C2<sub>hex</sub>)

Please observe that burst and polling mode cannot be active simultaneously (see also "HART Operating Mode (Polling/Burst) for Point-to-Point Connections and Multidrop Networks" on page 16).

#### Re-Scan

The HART interface is re-initialized via the Re-Scan bit. The UNIQUE\_IDENTIFIER... objects are deleted and the scan process is introduced again. In this way, all connected slaves on the affected HART channel are detected. During this process, the Scan Active bit is reset in the STATUS object.

The Re-Scan bit is cannot be read back in this object.

**Error Message of This Object:**

Error_Class	Error_Code	Additional_Code	Meaning
06 <sub>hex</sub>	02 <sub>hex</sub>	0000 <sub>hex</sub>	HART supply voltage not present
08 <sub>hex</sub>	00 <sub>hex</sub>	2020 <sub>hex</sub>	No HART slave found at the channel and polling or burst-command <> 0.
08 <sub>hex</sub>	00 <sub>hex</sub>	2022 <sub>hex</sub>	Scan phase active and (polling command <> 0 or burst-command <> 0).
08 <sub>hex</sub>	00 <sub>hex</sub>	2030 <sub>hex</sub>	Polling and burst command (both) <> 0.
08 <sub>hex</sub>	00 <sub>hex</sub>	2130 <sub>hex</sub>	Polling command > 3.
08 <sub>hex</sub>	00 <sub>hex</sub>	2230 <sub>hex</sub>	Re-Scan bit set and polling command <> 0 or burst-command <> 0.
08 <sub>hex</sub>	00 <sub>hex</sub>	2330 <sub>hex</sub>	A bit of the reserved bits 12, 13 or 14 is set.
08 <sub>hex</sub>	00 <sub>hex</sub>	2040 <sub>hex</sub>	Polling command <> 0 and burst mode still active.
08 <sub>hex</sub>	00 <sub>hex</sub>	2043 <sub>hex</sub>	Burst command <> 0 and polling mode still active.
08 <sub>hex</sub>	00 <sub>hex</sub>	2047 <sub>hex</sub>	Burst mode is to be enabled for multidrop environment.

**17.8 INIT\_TABLE Object**

Writing the INIT\_TABLE object with a Write service configures the terminal.

**Object Description**

Object	INIT_TABLE	
Access	Read, Write	
Data type	Array of Unsigned 16	14 x 2 bytes
Index	00C3 <sub>hex</sub>	
Subindex	00 <sub>hex</sub>	Write all elements
	01 <sub>hex</sub>	Analog configuration
	02 <sub>hex</sub>	Limit value for open circuit
	03 <sub>hex</sub>	Limit value for overrange
	04 <sub>hex</sub>	Reserved
	05 <sub>hex</sub>	Reserved
	06 <sub>hex</sub>	System settings
	07 <sub>hex</sub>	Reserved
	:	:
	0E <sub>hex</sub>	Reserved
Length (bytes)	For subindex 0, the length is 28 bytes. For subindex >0, the length is 2 bytes.	
Data	IB IL AI 2-HART terminal configuration	

**Element Description (Subindex)**

**Analog Configuration Element**

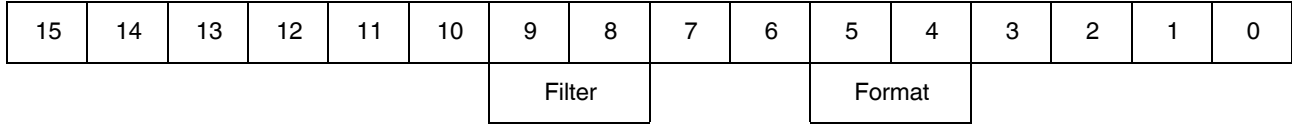

Figure 18 Assignment of the analog configuration element (index 00C3<sub>hex</sub>, subindex 1<sub>hex</sub>)

The options in bold are default settings.

Code	Filter
0	<b>16-fold mean value</b>
1	No mean-value generation
2	4-fold mean value
3	32-fold mean value

Code	Format
0	<b>IB IL 4 mA ... 20 mA</b>
1	Standardized representation
2	PIO
3	Reserved

**Open Circuit Element**

In the "Standardized representation" format this element is used to determine the limit value for open circuit. If the current falls below the limit value the error message open circuit 8002<sub>hex</sub> is indicated in the IN process data. By default, the value is 3200<sub>dec</sub>, which corresponds to 3.2 mA.

**Overrange Element**

In the "Standardized Representation" format this element is used to determine the limit value for overrange. If the current is above the limit value the Overrange error message 8001<sub>hex</sub> is indicated in the IN process data. By default, the value is 22500<sub>dec</sub>, which corresponds to 22.5 mA.

**System Settings Element**

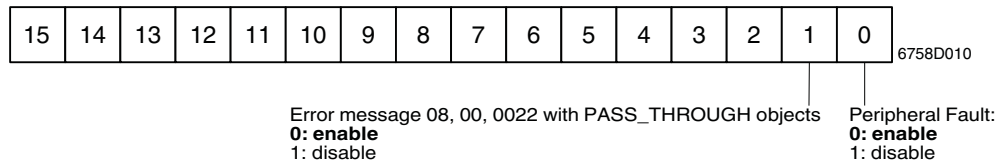

Figure 19 Assignment of the system settings element (index 00C3<sub>hex</sub>, subindex 06<sub>hex</sub>)

The Peripheral Fault that can be switched off, relates to the response of a supply voltage interrupt.

**Error Messages of This Object**

If a Write service writes an invalid value to an element, the service will be aborted with a negative confirmation.

Here, the parameters are the following:

Error_Class	Error_Code	Additional_Code	Meaning
08 <sub>hex</sub>	00 <sub>hex</sub>	xx30 <sub>hex</sub>	Value is out of range

The high byte of the ADDITIONAL\_CODE (xx) contains the number of the affected element. If several elements are affected, the highest number is given. If, for example, the "analog configuration" element is written with the value 0001<sub>hex</sub>, an error message with the ADDITIONAL\_CODE 0130<sub>hex</sub> will be displayed, because the first element is faulty.

## 18 Start Behavior

After power-up, the terminal searches both HART channels for possible slaves. To do this, the HART command 0 at the short addresses 0 up to 15 are sent in ascending order.

If the slave already responds to short address 0, the search process is aborted. If not, the search process continues until either the short address 15 is reached or the number of slaves detected equals five. For a command to short address 0, 6 different attempts have been executed where normally only 1 attempt takes place.

During this process being executed in parallel on both channels of the Inline HART terminal, the Scan Active bit is set.

From the detected slaves, the UNIQUE\_IDENTIFIER\_CHANNEL1/2\_SLAVE1...5 objects are read and can then be read via the 008x<sub>hex</sub> and 009x<sub>hex</sub> object indices. Among others the UNIQUE\_IDENTIFIERx object contains the unique 38-bit address of the HART slave.

The UNIQUE\_IDENTIFIERx objects are distributed onto the objects in the order in which they are found during the search process.

Example:

A multidrop network at the HART channel 1 comprises the short addresses 1, 3, 7, 12, and 14.

Distribution of the UNIQUE\_IDENTIFIER1 objects:

Index (hex)	Distribution	Description
0080	UNIQUE_IDENTIFIER_CHANNEL1_SLAVE1	Slave with short address 1
0081	UNIQUE_IDENTIFIER_CHANNEL1_SLAVE2	Slave with short address 3
0082	UNIQUE_IDENTIFIER_CHANNEL1_SLAVE3	Slave with short address 7
0083	UNIQUE_IDENTIFIER_CHANNEL1_SLAVE4	Slave with short address 12
0084	UNIQUE_IDENTIFIER_CHANNEL1_SLAVE5	Slave with short address 14

The number of detected slaves can be read via the STATUS (00C1<sub>hex</sub>) object.

After the search process, the Inline HART terminal waits for 4 seconds for a HART slave to send a burst telegram, if required. This case is possible because some HART slaves save there settings in a non-volatile memory. If a slave is in active burst mode, it continues to send burst telegrams after the voltage interrupt.

After having received a burst telegram, the Inline HART terminal sends a request telegram to the slave in question in order to switch off burst mode. Only then a search process starts.

### Duration of the Scan Process For the Worst Case (no HART device present):

Burst waiting time		4 seconds
6 messages to addresses 0	6 * 330 ms	= approx. 2 seconds
1 messages to addresses 1-15	15 * 330 ms	= approx. 5 seconds
Total		approx. 11 seconds