

Renesas Microcomputers General Presentation

Development Environment Emulators

Renesas Solutions Corp.
Microcomputer Tool Marketing Dept.

10/30/2007 Rev.10.00

Emulator line-up

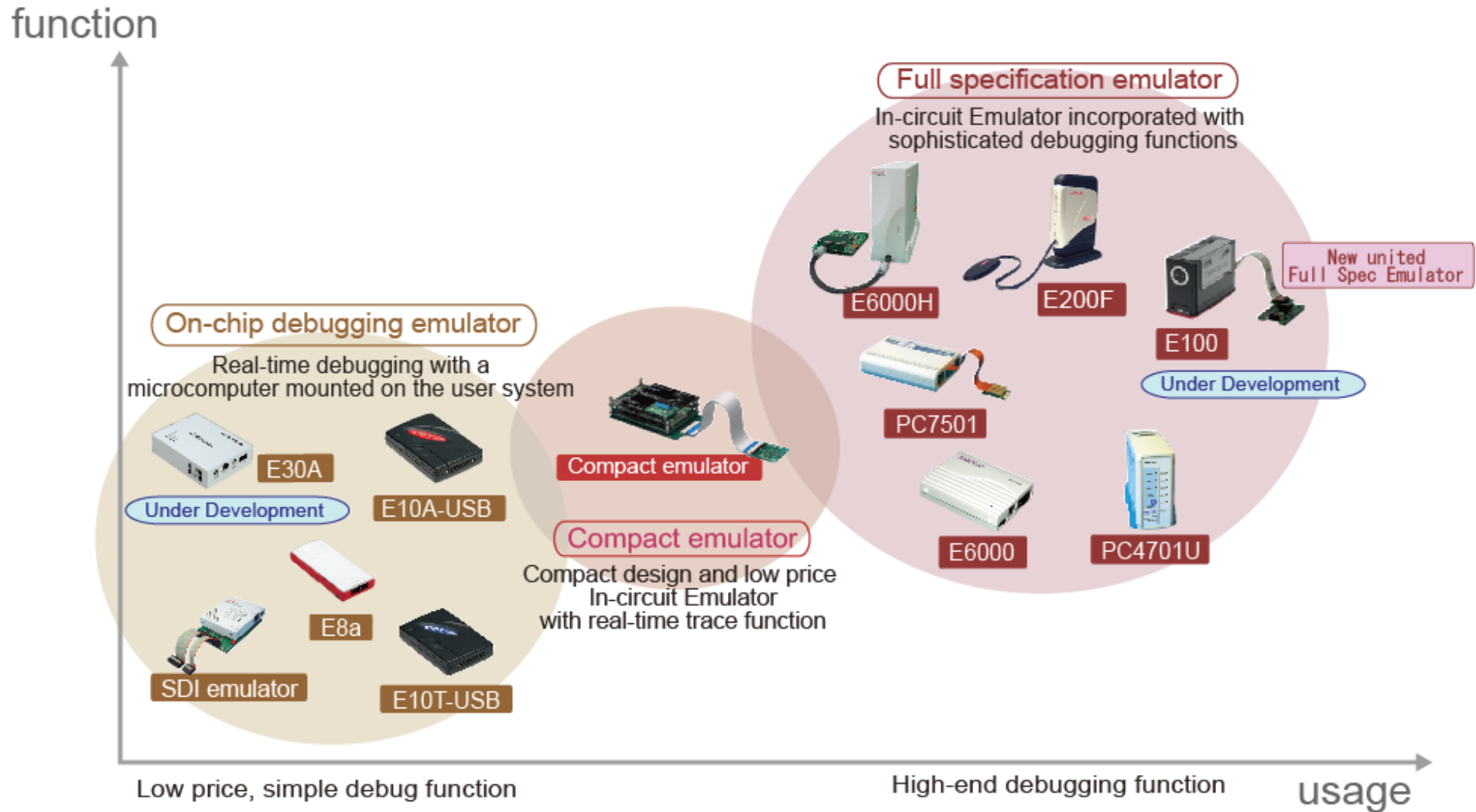

NEW Introduction of development tool Application Notes

| Emulator | Document Title |
|-------------|--|
| E8 | Renesas E8 Emulator Application Notes Introductory Guide for H8/300H Tiny |
| E10A-USB | Renesas E10A-USB Emulator Application Notes Introductory Guide for SH/Tiny (SH7125) |
| E6000H | H8SX Family Emulator E6000H Performance Measurement H8SX Family Emulator E6000H Usage of Real-time RAM Monitoring |
| E6000 | H8S Family Emulator E6000 Application Notes How to Use the Sequential |
| H8/300H CPE | H8/300H Tiny Series Compact Emulator Operating Back Trace ([Trace] Window) H8/300H Tiny Series Compact Emulator Using the GUI I/O Functions |

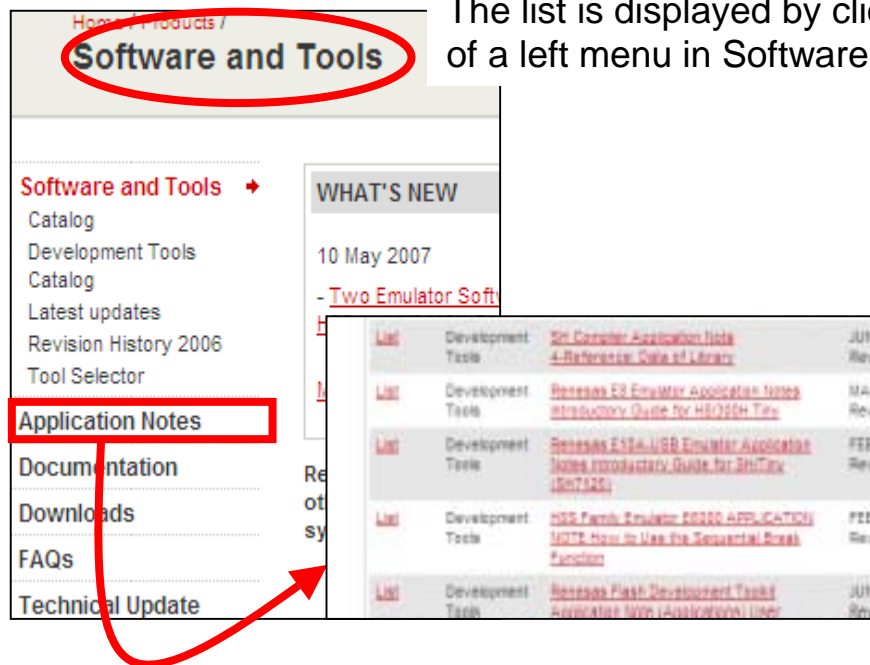

The list is displayed by clicking “Application Notes” of a left menu in Software and Tools Web site.

Schedule for the future

- E200F (How to use performance measurement, How to use profile measurement)
- PC7501 (How to Use the sequential break function, How to use graphic display of data trace function)
- Renesas E8 Emulator Application Notes Introductory Guide for R8C Tiny.
- E8a, E100

MEMO

A large empty rectangular box with a black border, intended for writing a memo.

E10A-USB Emulator

E10A-USB Supported Device Roadmap

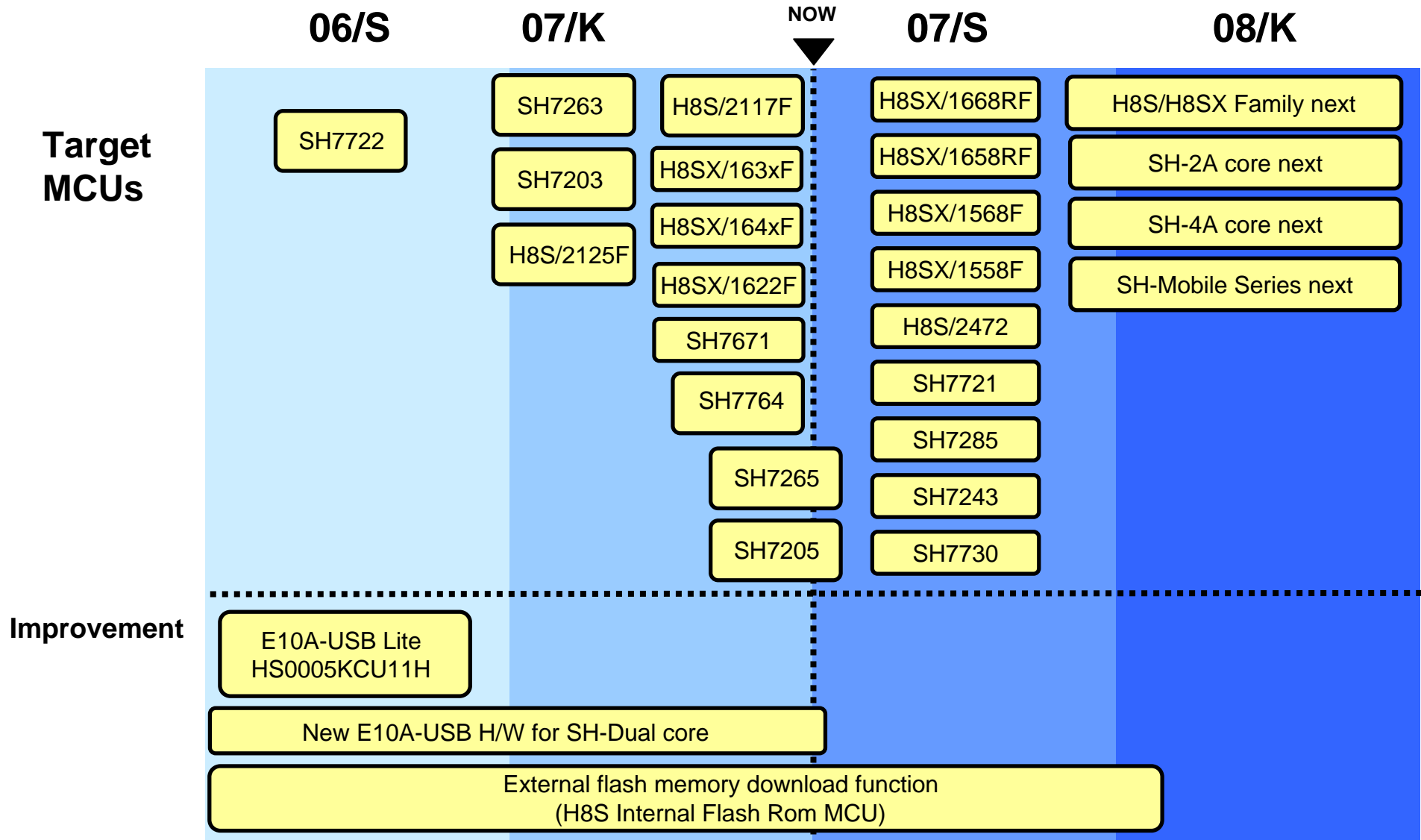

Features of the E10A-USB (1)

- **The OCD emulator excellent in cost performance.**

E10A-USB can be used with all microcomputers which has H-UDI function*.

The body size is very small as 97 mm × 65 mm × 22 mm.

*: except SH7055, SH7058, SH7059

- **Real time Emulation**

The real time emulation in the highest operation frequency of CPU is available.

- **Excellence Operationally**

This emulator is possible to debug for user program with pointing device (mouse etc.) by using High-performance Embedded Workshop that running on Microsoft® Windows XP® or Microsoft® Windows® 2000®.

Also, the emulator performs high-speed file download.

And the build environment and the debug environment can be integrated by installing it with the compiler package.

Features of the E10A-USB (2)

- **Substantial Debug Function**

Debug efficiency improvement by substantial break and trace function.
Set break point and break condition in exclusive window, display trace information to window.
Also, provide abundant command line function.

- **Debug for User System in product configuration**

The debug target configuration is almost same as the user's filial product system.

- **Debug environment using USB interface**

The E10A-USB can be used in both of laptop PC and desktop PC since PC interface is USB. And the emulator is USB bus powered.

Note1: E10A-USB Emulator software for SH requires SuperH RISC engine C/C++ compiler package Ver.6 or later.
Microcomputer of SH-4A core and SH4AL-DSP core requires SuperH RISC engine C/C++ compiler package Ver.8 or later.

Microcomputer of SH-2A core requires SuperH RISC engine C/C++ compiler package Ver.9 or later.

Note2 : E10A-USB Emulator software for H8S requires H8S, H8/300 C/C++ compiler package Ver.4 or later.
H8SX family requires H8SX, H8S, H8/300 C/C++ compiler package Ver.6 or later.

System configuration of the E10A-USB Emulator (1)

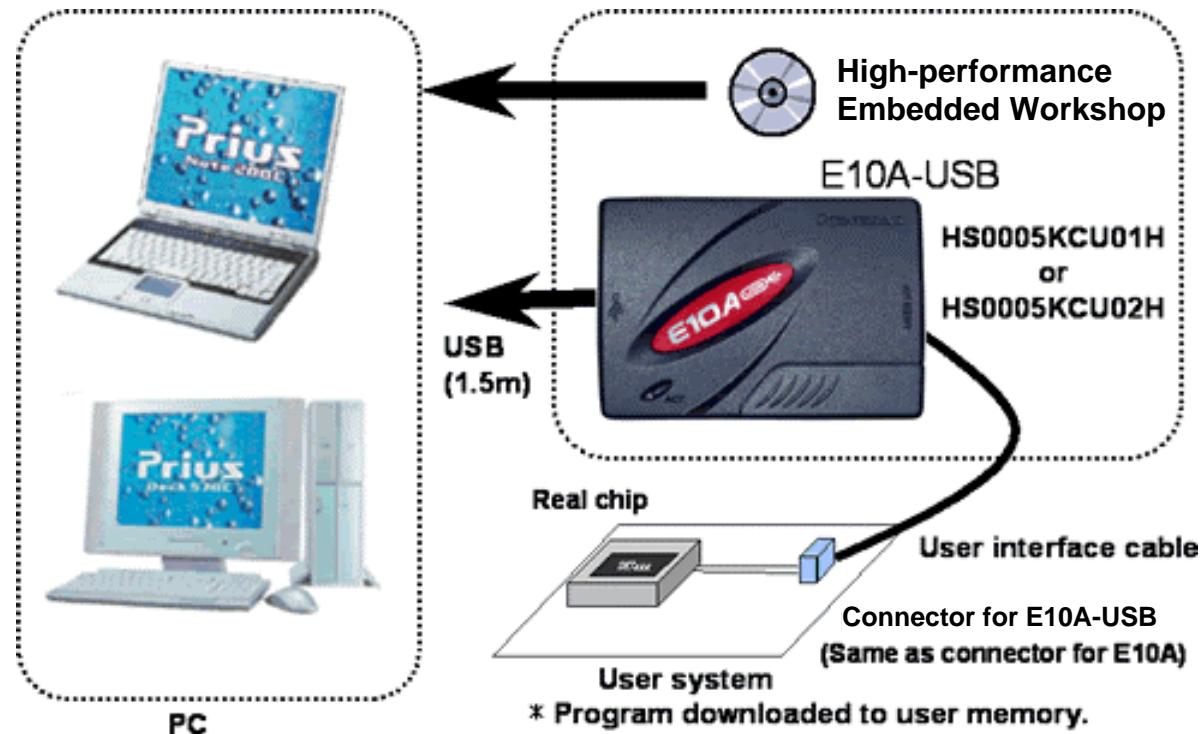

Note1: Note that the pin assignments of the H-UDI port connector is different from those of the connector manufacturer

System configuration of the E10A-USB Emulator (2)

Initial Purchase



Notes on Installation for Prospective Purchasers

You do not need to purchase a Device Group Addition (License Tool for Device Group Additions) to support the first device group, the E10A-USB is shipped with an installer that allows the user to support any one of these.

Our range of Device Group Additions are for adding subsequent device groups to an existing system. Refer to the Product Configuration on the E10A-USB home page for further details. Further information is available from your Renesas distributor or sales representative.

System configuration of the E10A-USB Emulator (3)

Subsequent Purchase



How to install additional device groups

If the user subsequently wishes to upgrade their E10A-USB to support an additional device group, Device Group Additions (License Tool for Device Group Additions) are available as additional purchases (subject to release schedule). The Device Addition is supplied as a CD-ROM with the desired Group software. This is used in conjunction with the original E10A-USB unit.

Note: It is possible for one E10A-USB unit to support ALL of these devices groups if all of the Device Group Additions are purchased and installed.

Table1 E10A-USB Product lineup

| Part No. | E10A-USB | User I/F cable | Remarks |
|--------------|----------------------------------|-------------------|--|
| HS0005KCU01H | Type A (without AUD function) | 14 pins | High-performance Embedded Workshop included (with license for one device group) |
| HS0005KCU02H | Type B (with AUD function) | 14 pins + 36 pins | High-performance Embedded Workshop included (with license for one device group) |
| HS0005KCU04H | Type C (with AUD function) | 14 pins + 38 pins | For SH7265 and SH7205 |

Table2 E10A-USB “License tool for device group addition” product lineup

| Part No. | Device group |
|---------------|---------------|
| HS2339KCU01SR | H8S |
| HS1527KCU01SR | H8SX |
| HS7047KCU01SR | SH-2 |
| HS7206KCU01SR | SH-2A |
| HS7729KCU01SR | SH-3 |
| HS7290KCU01SR | SH-Mobile |
| HS7318KCU01SR | New SH-Mobile |
| HS7751KCU01SR | SH-4 |
| HS7780KCU01SR | SH-4A |

Table3 E10A-USB support device list for H8S Family and H8SX Family

| Device group | Supported device | Shipment schedule |
|-------------------|--|--------------------|
| H8S device group | H8S/2212F, H8S/2212UF, H8S/2218F, H8S/2218UF, H8S/2377F, H8S/2377RF, H8S/2378F, H8S/2378RF, H8S/2374RF*, H8S/2372RF*, H8S/2371RF*, H8S/2370RF*, H8S/2374F*, H8S/2372F*, H8S/2371F*, H8S/2370F*, H8S/2364F*, H8S/2362F*, H8S/2361F*, H8S/2360F*, H8S/2367F, H8S/2368F, H8S/2168F, H8S/2167F, H8S/2166F, H8S/2437F, H8S/2114F, H8S/2339EF, H8S/2329EF, H8S/2319EF, H8S/2170F, H8S/2171F, H8S/2172F, H8S/2158F, H8S/2189RF, H8S/2116F, H8S/2437F, H8S/2215RF, H8S/2125F, H8S/2215TF*, H8S/2215URF*, H8S/2215TUF*, H8S/2117F, R8J32500, R8J32700, H8S_custom_SoC(2000), H8S_custom_SoC(2600) | In mass production |
| | H8S/2472 | T.B.D. |
| H8SX device group | H8SX/1527F, H8SX/1525F, H8SX/1582F, H8SX/1653F, H8SX/1654F, H8SX/1663F, H8SX/1664F, H8SX/1651, H8SX/1527RF, H8SX/1544F, H8SX/1543, H8SX/1622F, H8SX/1632F, H8SX/1634F, H8SX/1638F, H8SX/1642F, H8SX/1644F, H8SX/1648F | In mass production |
| | H8SX/1668RF, H8SX/1658RF, H8SX/1568F, H8SX/1558F | Nov-07 |

*: When using E10A-USB emulator with these devices, please select the following device name instead.

| Using device | Selecting device name |
|--|-----------------------|
| H8S/2374RF, H8S/2372RF, H8S/2371RF, H8S/2370RF | H8S/2378RF |
| H8S/2374F, H8S/2372F, H8S/2371F, H8S/2370F | H8S/2378F |
| H8S/2364F, H8S/2362F, H8S/2361F, H8S/2360F | H8S/2368F |
| H8S/2215TF, H8S/2215URF, H8S/2215TUF | H8S/2215RF |

Table4 E10A-USB support device list for SH family

| Device group | Supported device | Shipment schedule |
|----------------------------|---|--------------------|
| SH-2 device group | SH7615, SH7616, SH7047F, SH7144F, SH7145F, SH/Tiny Debug MCU Board R5F70834A, R5F70835A, R5F70844A, R5F70845A, R5F70854A, R5F70855A, R5F70865A, R5E70835R, R5E70845R, R5E70855R, R5E70865R, R5E71464R, R5E71494R (R5E71491R), SH7618, SH7618A, SH7619, SH7606, SH7125, SH7124, R5F71464R, R5F71494R (R5F71491R), R5F71464A, R5F71494A | In mass production |
| SH-2A device group | SH7206, SH7211F, SH7261, SH7201, SH7263, SH7203, SH7670, SH7671, SH7672, SH7673 | In mass production |
| | SH7285, SH7243 | Nov-07 |
| SH-3 device group | SH7705, SH7710, SH7712, SH7713*, SH7720 Series, SH7630, SH7641, SH7660, SH7660A, SH7729, SH7709A, SH7729R, SH7709S, SH7727, SH7706, SH-3(core)_custom_SoC | In mass production |
| | SH7721 | Nov-07 |
| SH-Mobile device group | SH-Mobile1, SH-MobileJ, SH-MobileV, SH-MobileJ2 SH-MobileV2, SH-MobileL, SH-MobileL2, SH-MobileJ3 | In mass production |
| New SH-Mobile device group | SH-Mobile3, SH-Mobile3A, SH-MobileR (SH7722) | In mass production |
| SH-4 device group | SH7750S, SH7750R, SH7751, SH7751R, SH7760 SH7750Rbase_SOC | In mass production |
| SH-4A device group | SH7763, SH7770, SH7780, SH7781, SH7785, SH7774, SH7764 | In mass production |
| | SH7730 | Nov-07 |

* : When using E10A-USB emulator with SH7713, please select SH7712 device name instead.

NEW “E10A-USB” for Multi-core devices

- New “E10A-USB” variation for SH7205 and SH7265
 - Multi Core + Single Debugging Module in the device.
Single debugging module can control two CPUs.
 - Single 38-pin H-UDI connector can be used for dual core.

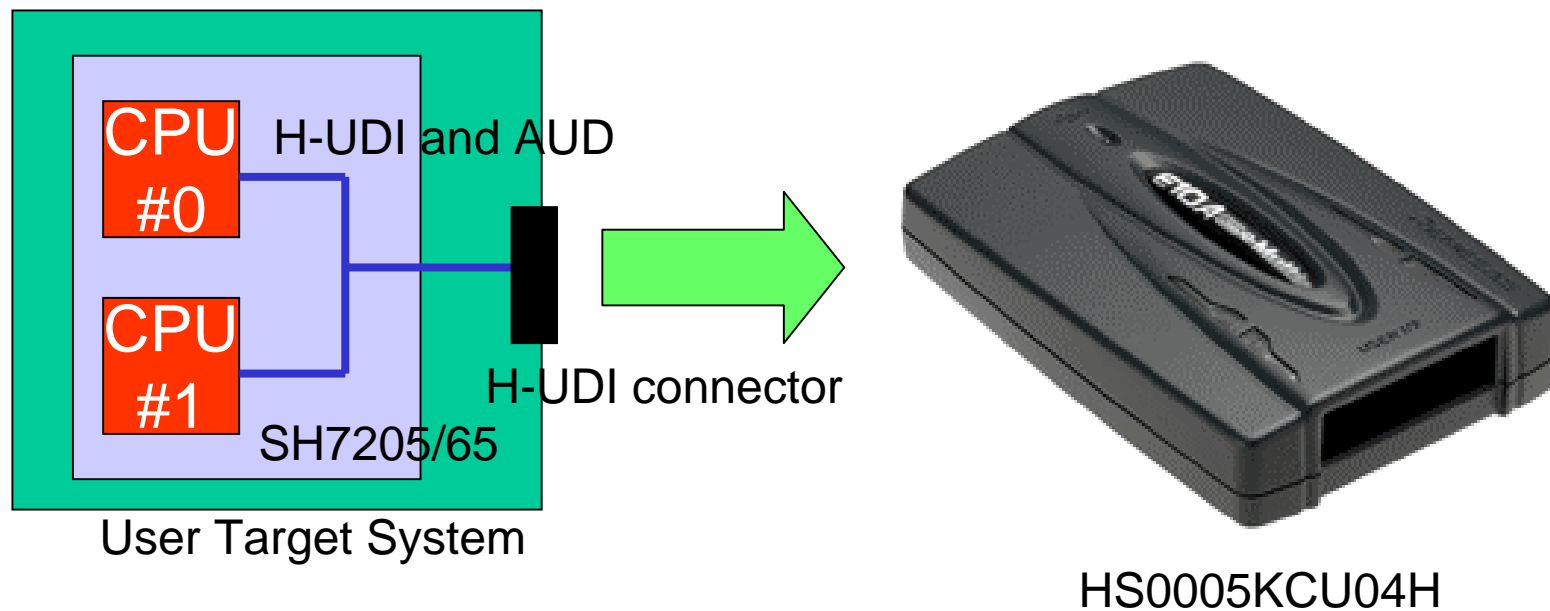

E10A-USB for SH7205/7265 features

| | CPU#0 | CPU#1 |
|----------------------|---|------------|
| On Chip Break | 10 | |
| Performance Analysis | 4 | 4 |
| AUD Trace | 32 Kcycles Branch instructions/Memory Access/Software Condition can be set each CPU | |
| Build-In Trace | 512 Cycles | 512 Cycles |
| | 1024 Cycles | |

NEW Build Example for AMP

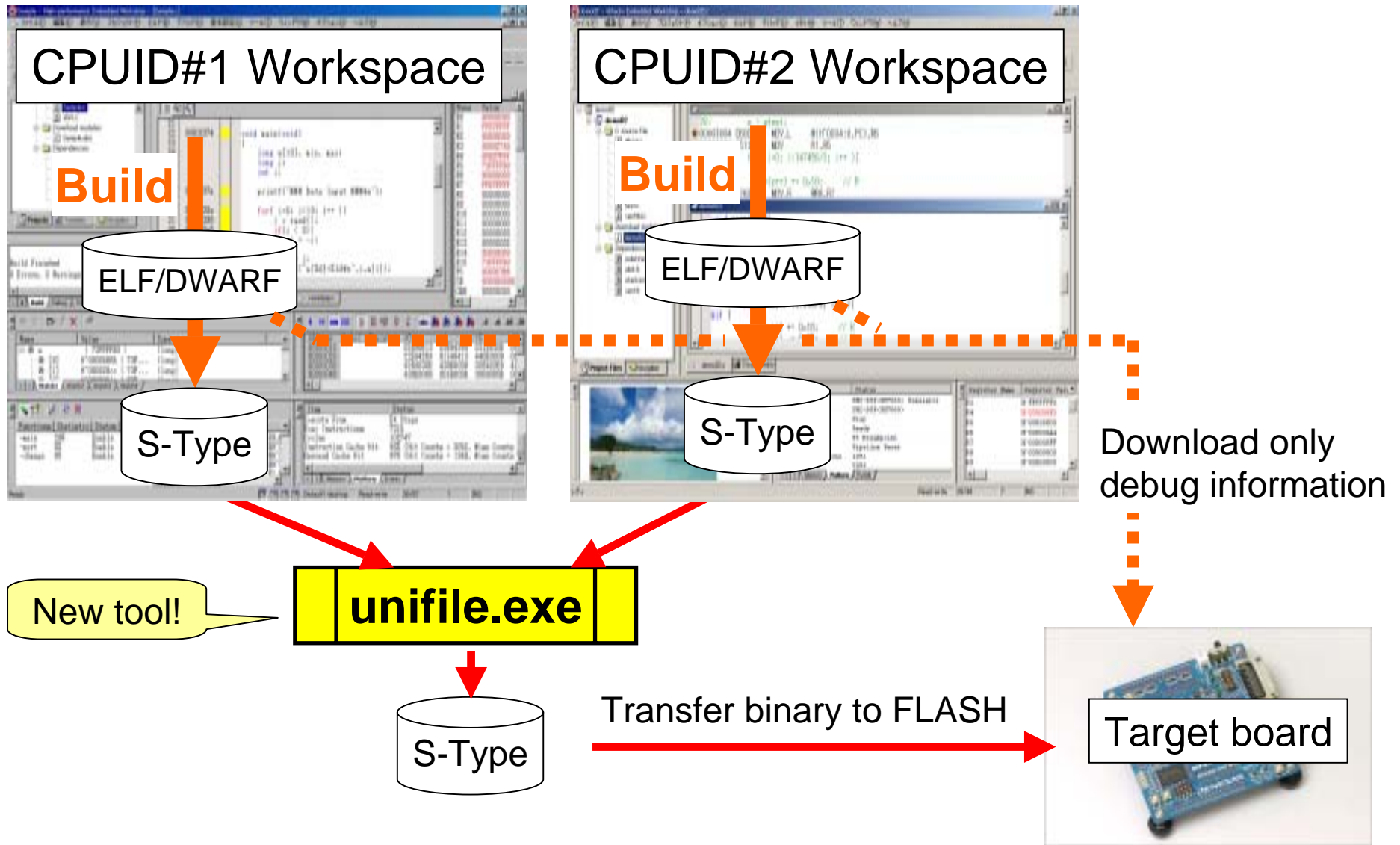

SH/Tiny Debug MCU Board

"SH/Tiny debug MCU board" is an optional board for SH/Tiny Series (SH7124 and SH7125) to use the E10A-USB on-chip debugging emulator as an in-circuit emulator. This optional board allows debug functions of which the in-circuit emulator originally has, such as performance measurement and trace, to be used with E10A-USB emulator, and all dual purpose terminals (for H-UDI and user functions) of the SH/Tiny Series (SH7124 and SH7125) to be used for user functions exclusively.

Mass-produced chips of the SH/Tiny Series (SH7124 and SH7125) do not incorporate an AUD function, performance function, or trace memory.

Multiplexing of the H-UDI pins with pins for user functions makes it impossible to use the E10A-USB for debugging of user functions.

System composition for use of SH/Tiny debug MCU board

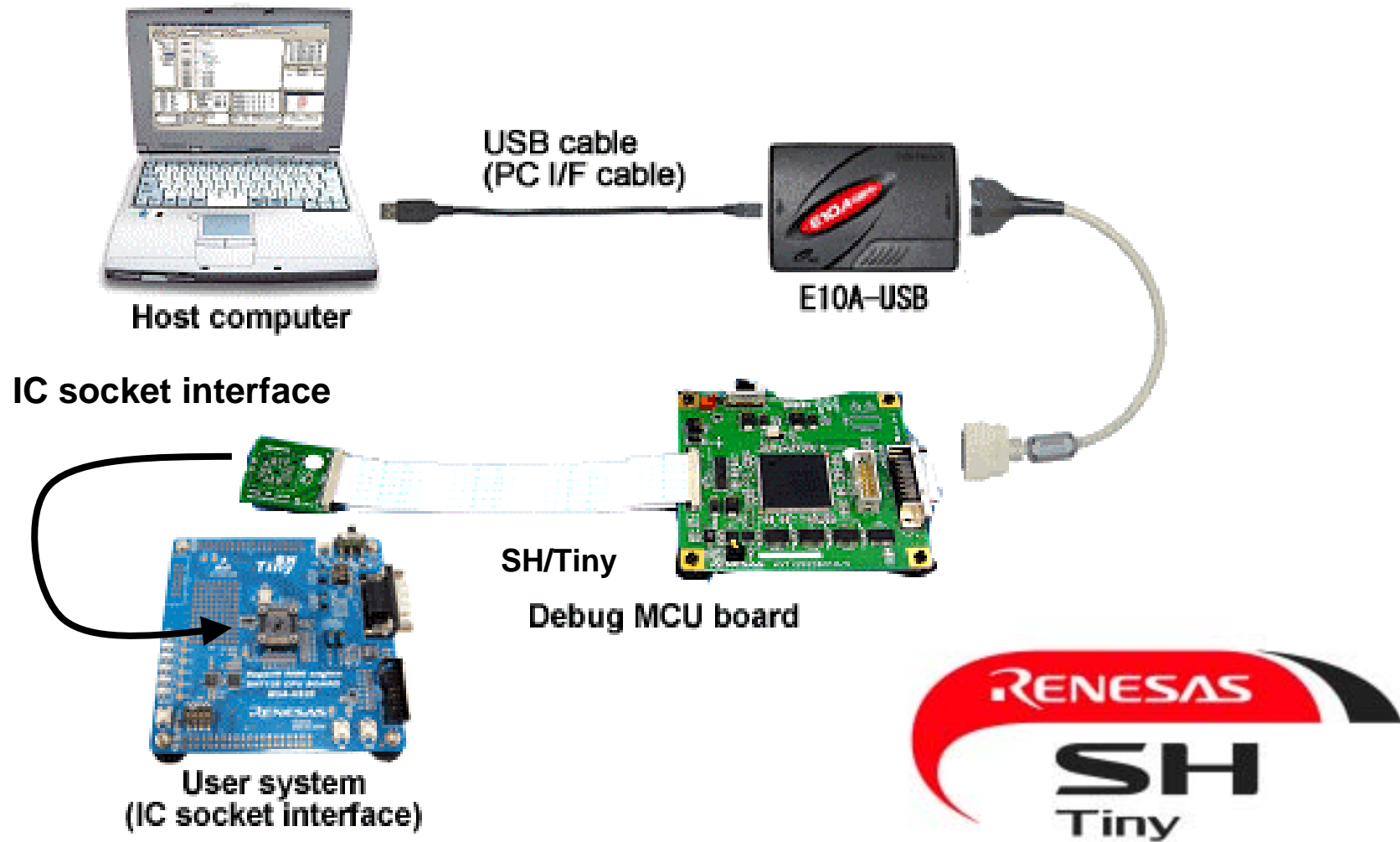

Product type name of SH/Tiny debug MCU board

| Series | Group | E10A-USB (HS0005KCU02H) + SH/Tiny Debug MCU board | SH/Tiny Debug MCU board |
|---------|--------|---|---|
| | SH7124 | HS7124EDB01H-E1 (PLQP0048JA-A (FP-48F)) | HS7124EDB01H (PLQP0048JA-A (FP-48F)) |
| SH/Tiny | | HS7125EDB01H-E1 (PLQP0064KB-A (FP-64K)) | HS7125EDB01H (PLQP0064KB-A (FP-64K)) |
| | SH7125 | HS7125EDB02H-E1 (PRQP0064GB-A (FP-64A)) | HS7125EDB02H (PRQP0064GB-A (FP-64A)) |

Specifications of SH/Tiny debug MCU board

| | |
|---|---|
| Supported MCU | SuperH RISC engine Family SH/Tiny (SH7125) Series SH7124, SH7125 Group |
| Power supply to SH/Tiny Debug MCU board | The following two ways of powering are available. (1) To supply via the Vcc terminal on the target board. (Max. 300 mA) (2) To supply externally via the power terminal on the SH/Tiny Debug MCU board. (5 V) |
| Connection to target system | Plug into the IC socket on the target board. |
| Connection to E10A-USB emulator | H-UDI (with AUD) : 14 pins H-UDI (without AUD) : 36 pins |
| External dimension | Body: 80 mm × 85 mm Cable: 150 mm (flexible cable) Cable head: 40 mm × 35 mm |
| Bundled Accessory | Applicable IC Socket for MCU package (qty.1) |

NEW Features in using with SH/Tiny Debug MCU board

AUD trace (256 Kcycles)
 AUD break (8)
 Real-time profile
 C0 coverage

E200F



AUD trace(16 Kbranches)
 Bus trace (1 Kcycles)
 Performance measurement
 All user pins: available

**E10A-USB
 +
 SH/Tiny
 Debug MCU
 board**

Downloading a program
 GO/BREAK
 STEP
 PC Break condition
 On-chip event point
 Reading of memory
 /Writing of memory
 Watching variables
 Branch trace (8 branches)

E10A-USB



SH/Tiny Debug MCU board

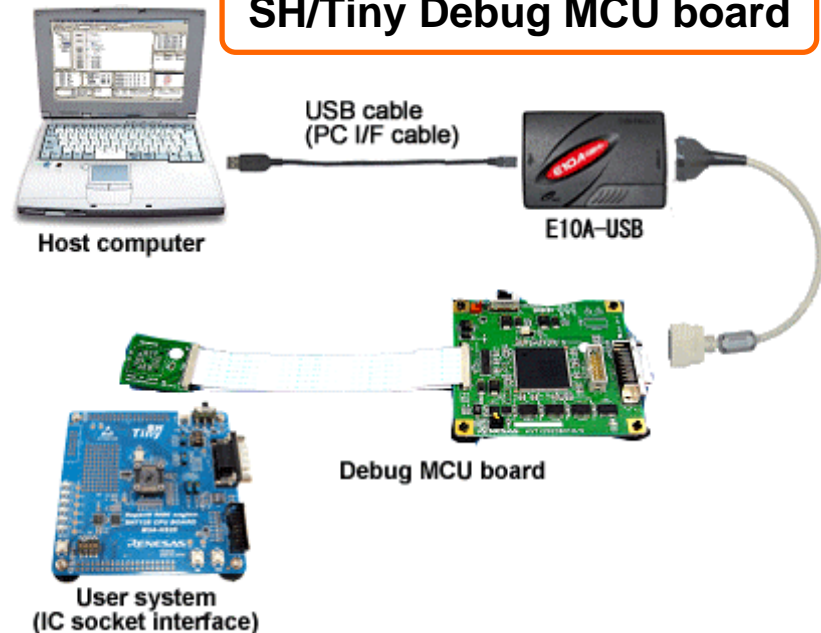

Real-time profile

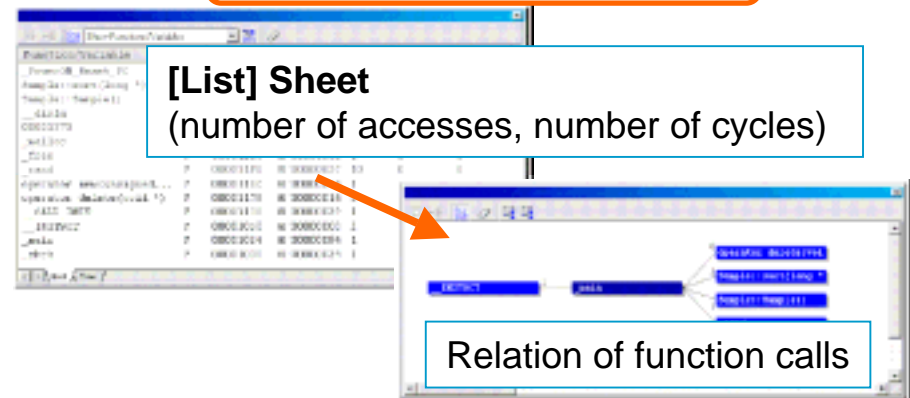

SH/Tiny Debug MCU board information on the WEB

http://www.renesas.com/e10a_usb ← Top page of E10A-USB

The screenshot shows the Renesas website interface for the E10A-USB product. At the top, the Renesas logo and navigation tabs (PRODUCTS, APPLICATIONS, SUPPORT) are visible. Search and part number input fields are present. The breadcrumb trail reads: Home / Products / Software and Tools / Emulation and D... / E10A-USB. A sidebar on the left lists various product details, with 'Debug MCU Board' highlighted by a red circle. The main content area features a 'Full Product Info' button, a table of contents, an overview section describing the board as an optional in-circuit emulator, and a system configuration diagram showing a host computer connected to the E10A-USB, which is in turn connected to a user system (IC socket interface) via a USB cable and a debug MCU board.

HS0005ECK01H

[Overview]

User interface cable for Mictor 38-pin connector is an optional cable to connect the E10A-USB emulator (HS0005KCU02H) to the Mictor 38-pin connector (2-5767004-2: Tyco electronics AMP K.K.) mounted on the user system.

[System Configuration]

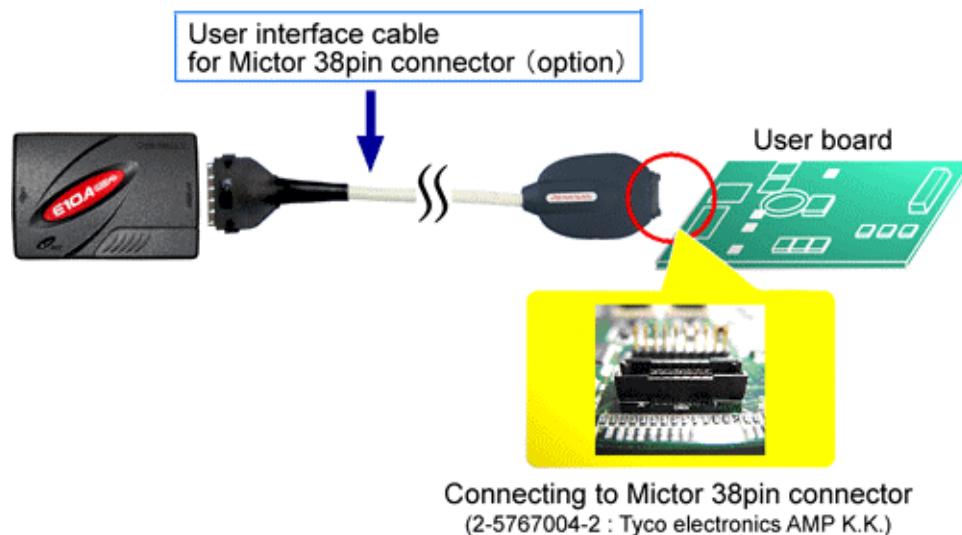

[Product type name]
HS0005ECK01H

[Following boards need HS0005ECK01H]
- SH7785 Solution Engine
- SH7722 Solution Engine

*: Mictor 38 pin-connector is also used when connecting the E200F emulator for SH7785 (R0E0200F2EMU00) to the user system.

Pin Assignments of S0005ECK01H

| Pin NO. | Signal*4 | Input/ Output*1 | Note | Pin NO. | Signal*4 | Input/ Output *1 | Note |
|---------|----------------------|--------------------|------------|---------|------------|---------------------|------|
| 1 | N.C. | - | | 20 | N.C. | - | |
| 2 | N.C. | - | | 21 | TRST# *2 | Input | |
| 3 | MPMD(GND) | - | | 22 | N.C. | - | |
| 4 | N.C. | - | | 23 | N.C. | - | |
| 5 | UCON#(GND)*3 | - | | 24 | AUDATA3 | Output | |
| 6 | AUDCK | Output | | 25 | N.C. | - | |
| 7 | N.C. | - | | 26 | AUDATA2 | Output | |
| 8 | ASEBRK#/ BRKACK*2 | Input/ Output | | 27 | N.C. | - | |
| 9 | RESET#*2 | Output | User reset | 28 | AUDATA1 | Output | |
| 10 | N.C. | - | | 29 | N.C. | - | |
| 11 | TDO | Output | | 30 | AUDATA0 | Output | |
| 12 | UVCC_AUD | Output | | 31 | N.C. | - | |
| 13 | N.C. | - | | 32 | AUDSYNC#*2 | Output | |
| 14 | UVCC | Output | | 33 | N.C. | - | |
| 15 | TCK | Input | | 34 | AUDRST#*2 | - | |
| 16 | N.C. | - | | 35 | N.C. | - | |
| 17 | TMS | Input | | 36 | AUDMD | - | |
| 18 | N.C. | - | | 37 | N.C. | - | |
| 19 | TDI | Input | | 38 | N.C. | - | |

*1: Input to or output from the user system.

*2: The symbol "#" means that the signal is active-low.

*3: The emulator monitors the GND signal of the user system to detect whether or not the user system is connected.

*4: Signal names are not intended to correspond to those for the actual MCU. Refer to recommended circuits and notes described in the Supplementary Information on Using the SHxxx and connect only the required signals. Other than UVCC_AUD, the signals are the same as those for the 36-pin interface. Supply the operating voltage of the AUD to UVCC_AUD.

Notes:

- The GND bus leads, which are allocated on the center of the H-UDI port connector, must be connected to GND.
- When an MCU incorporating the AUD with the SSTL18 specification (e.g., the SH7785) is used, the emulator is used with the same circuit as for the E200F. For details, refer to the E200F emulator additional document (Supplementary Information on Using the SHxxx).

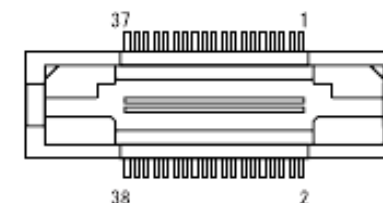

H-UI Port connector
(top view)

E10A-USB Lite

- Nickname: E10A-USB Lite
- Product Name: HS0005KCU11H



Features

- Supported device groups
H8S/ H8SX/ SH-2/ SH-2A
These 4-device group licenses are pre-installed at shipment.
- The other device group license can not be added to E10A-USB Lite.
- Renesas will ship E10A-USB Lite to oversea customer, but not to Japan.
- Debug function of E10A-USB Lite is same as HS0005KCU01H.
- Low price.

The pin number assignments of the connector (14-pin type)

The pin number assignments of the 14-pin connector differ from those of the E8 emulator. however, the physical location is the same.

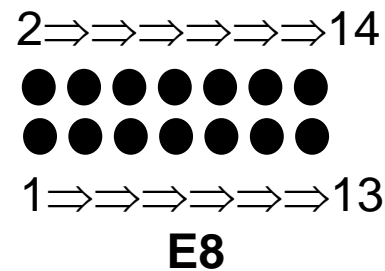
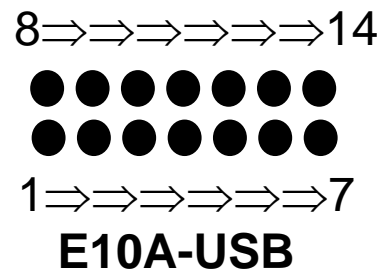

The pin number assignments of the connector differ from those of the connector manufacturer.

The function of the download to the external Flash memory for SH

The E10A-USB emulator for SuperH family (SH7047F/SH7144F/SH7145F is excluded) have the function of the download to the external Flash memory.

This function supports only the download of the program, and cannot edit the data of external Flash memory in the memory window. Moreover, the software break cannot be set to the program in the external Flash memory. Please use the hardware break.

Preparation to download program to the external Flash memory (1)

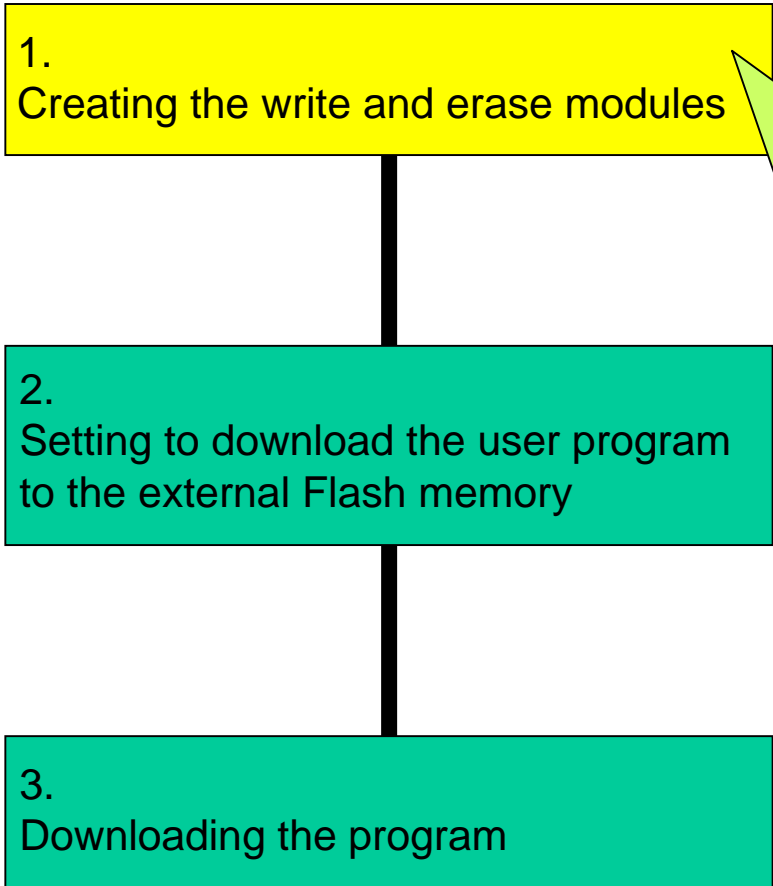

When E10A-USB download the program to the external Flash memory, SH microcomputer on the User system writes data to the external Flash memory.

When E10A-USB write to the external Flash memory, the writing method (address and how to send data) is different according to each Flash memory manufacturer and the width of connected bus.

It is necessary to make the program (write and erase modules) for writing the user program to the external Flash memory. Please confirm the data sheet of the external Flash memory and make the program (write and erase modules) .

Specification of Write and erase modules

- Interface with write and erase modules and emulator firmware
The write and erase modules must be branched from the emulator firmware. To branch from the emulator firmware to the write and erase modules, or to return from the write and erase module to the emulator firmware, the following conditions must be observed:
 - Describe all the write and erase modules with the assembly language.
 - Save and return all the general register values and control register values before and after calling the write or erase module.
 - Return the write or erase module to the calling source after processing.
 - The write and erase module must be a Motorola-type file.

Table 6.3 Module Interface

| Module Name | Argument | Return Value |
|--------------|--|---|
| Write module | R4(L): Write address R7(L): Verify option 0 = no verify, 1 = verify R5(L): Access size 0x4220 = byte, 0x5720 = word, 0x4C20 = longword R6(L): Write data | R0(L): End code Normal end = 0, Abnormal end = other than 0, Verify error = BT |
| Erase module | R4(L): Access size 0x4220 = byte, 0x5720 = word, 0x4C20 = longword | None |

Note: The (L) means the longword size.

Preparation to download program to the external Flash memory (2)

1.
Creating the write and erase modules

2.
Setting to download the user program to the external Flash memory

3.
Downloading the program

The download function of E10A-USB usually writes the program to RAM area.

When E10A-USB download the program to the external Flash memory, it is necessary to use the write and erase modules, and write the user program. Therefore, it is necessary to set the [Loading flash memory] page in the [Configuration] dialog box to download the user program to the external flash memory.

E10A-USB transfer the write and erase modules to RAM (internal RAM is also available) in the user system, and use them.

Preparation to download program to the external Flash memory (3)

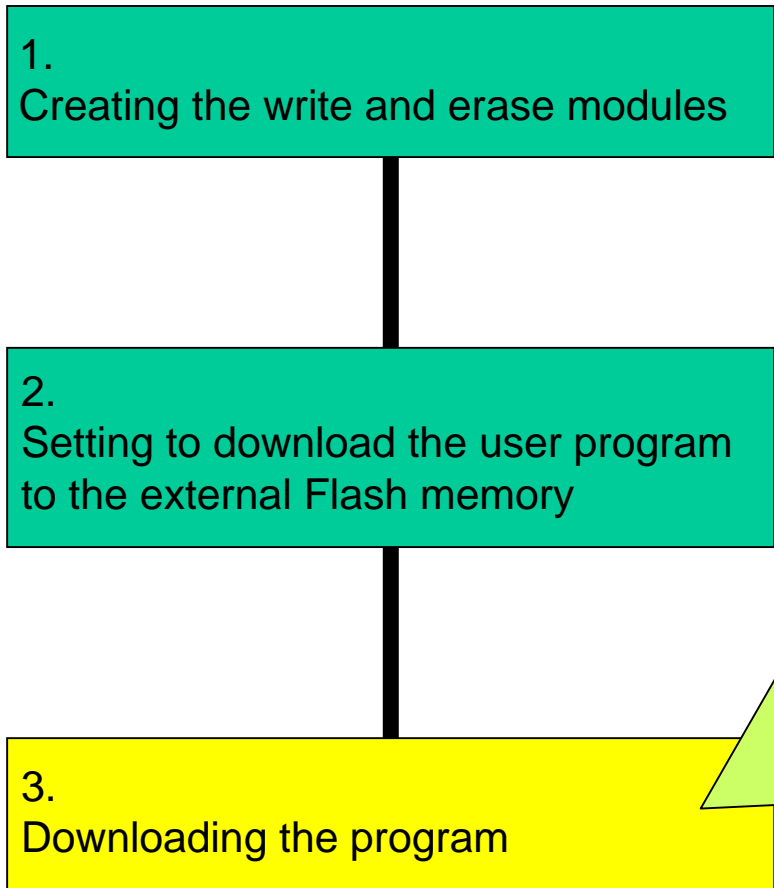

Please download the user program which you want to download to the external flash memory using the program loading function as well as the program download to RAM area.

At first, E10A-USB transfer the write and erase modules to RAM area that is specified, and use them to download the user program to the external Flash memory.

The download time of the E10A-USB emulator is usually 400 KB/second. However, it takes more time to download to the external Flash memory, because the time that is transferred and written to the Flash memory is necessary.

Introduce of application note

It is possible to download the sample program and the application notes that introduces the point of customize, and the setting of the Loading flash memory page from the following WEB.

- E10A-USB site

http://www.renesas.com/fmwk.jsp?cnt=e10a_usb_tools_product_landing.jsp&fp=/products/tools/emulation_debugging/onchip_debuggers/e10ausb/

→ Flash memory download program for the E10A-USB*

*: Flash memory manufacturer that can download it from WEB

Intel

Fujitsu

(Renesas Technology)

The sample program for 32-bit bus that uses four Flash memories (G28F640J5-150) made by Intel is appended to the E10A-USB emulator.

Content of application note

Flash Memory from FUJITSU

File name: FMTOOL.src

```

=====
;|
;| Flash memory tool program sample
;|   SuperH Family Flash memory load is supported
;|   Copyright (C) 2004 Renesas Technology Corp. All rights reserved.
;|   Licensed Material of Renesas Technology Corp.
;|
;|   Erasing flash memory routine top address : O_FMErase
;|   Writing flash memory routine top address : O_FMWrite
;|   Stack pointer address                   : FM_TOOL_STACK
;|   Flash memory top address                : FM_TOP_ADDRESS
;|
;| Target flash memory : FUJITSU [Word mode]
;|
=====
;
;
=====
;|   EQU
;|
;|
;|
;|   O_FMErase       .equ  H'2c001000
;|   O_FMWrite       .equ  H'2c001100
;|   FM_TOOL_STACK   .equ  H'2c002000
;|   FM_TOP_ADDRESS  .equ  H'20000000
;|
;|   FM_CMD_RESET    .equ  H'000000F0
;|   FM_CHK_DQ7      .equ  H'00000080
;|   FM_CHK_DQ5      .equ  H'00000020
;|
;|   FM_OK            .equ  H'0000
;|   FM_BT            .equ  H'4254
;|
;|   TYPE_BYTE       .equ  H'4220
;|   TYPE_WORD       .equ  H'5720
;|   TYPE_LONG       .equ  H'4c20
;|
;|
;|
;|   .align 4

```

Start address of the erase module
 The RAM area in the user system is used. Secure the size of H'100 bytes or more.

Start address of the write module
 The RAM area in the user system is used. Secure the size of H'800 bytes or more.

Start address of the stack area for write/erase module
 The RAM area in the user system is used. Secure the size of H'100 bytes or more.

Start address of the flash memory in the user system
 Set the start address of the flash memory area in the user system.

Download information on the WEB

Region: GLOBAL 日本 | 서울 | 上海 | 臺北 MY RENESAS COMPANY INFO NEWS & EVENTS CONTACT US

RENESAS
Everywhere you imagine

PRODUCTS APPLICATIONS SUPPORT

Enter a Keyword **GO** Enter a Part No. **GO**

Parametric Search Document Library

Home / Products / Software and Tools / Emulation and Debugging / On-chip Debuggers (HW) / E10A-USB /

Flash Memory Download Program

Provide feedback Print this page

E10A-USB

- Target Devices
- System Configuration
- Features
- Components
- Device Group Additions
- Specification
- Installation and Setup
 - Flash Memory** →
 - Download Program
 - Debug MCU Board
- User interface cable for Mictor 38pin connector
- Upgrade Information

Documentation

FAQs

Technical Update

Downloads

Options

Full Product Info

Flash Memory Download Program for the E10A-USB Emulator

The E10A-USB emulator is equipped with the download function to the flash memory. The user needs to prepare a download program to use this function.

Important Information

Before creating an Application Note available below, the operation has been confirmed by Renesas. However, this does not mean that the Renesas is responsible for guaranteed operation. Before reading the Application Note, please refer to the section of Download Function to the Flash Memory Area, in the Debugger Part of the E10A-USB emulator user's manual for each microcomputer family (HS0005KCU01HE).

Please note that Renesas does not offer any technical support about what is written in the following documents and introduced sample programs below.

Read First

Guide to Using the Download Program to Flash Memory for the E10A-USB Emulator :

This document is a guide to practically use the Application Note introduced on the web site. This guide explains some points of each document introduced on the web site so that the users can write the program efficiently.

Application Note:

In this Application Note, the sample program of the download program is given, together with customization and downloading procedure using the E10A-USB emulator.

Customization of Flash Memory Download Program for E10A-USB Emulator :

Points to be noted when creating the write and erase modules for writing to the flash memory, which is not stated on the web site, is described.

The function of download to the external Flash memory of E10A-USB for H8SX and H8S (1)

The E10A-USB emulator for the H8SX supports debugging in the external flash memory.

- Function

E10A-USB emulator for the H8SX supports the following function.

- (1) The function of download program to the external Flash memory
- (2) Setting of software break to the external Flash memory
- (3) Editing the data of the external Flash memory in the memory window

- Target MCU

H8SX/1544F, H8SX/1543F, H8SX/1651

H8SX/1653F, H8SX/1654F, H8SX/1663F, H8SX/1664F

The new products of H8SX will use the function of download to the external Flash memory.

In H8S family, only the SoC installed on the H8S can use the function of download to the external Flash memory.

H8S/2426F, H8S/2424F, H8S/2456F and H8S/2454F are under planning.

NEW The function of download to the external Flash memory of E10A-USB for H8SX and H8S (2)

- Application note

It is necessary to make the program (write and erase modules) for writing the user program to the external Flash memory. Please confirm the data sheet of the external Flash memory and make the program (write and erase modules).

It is possible to download the sample program and the Application Notes that introduces the point of customize, and the setting of the External Flash memory setting page from the following WEB.

- E10A-USB site

http://www.renesas.com/e10a_usb

→ Flash memory download program

The screenshot shows the Renesas website navigation menu with 'E10A-USB' highlighted. Below the navigation is a sidebar with 'Flash Memory Download Program' highlighted. A red arrow points from this sidebar item to a table titled 'H8S, H8SX Family Flash Memory Download Program'. The table lists various programming types, manufacturers (Toshiba and Renesas Technology), target MCUs (H8S, H8SX), and provides download links for sample programs and application notes.

| Flash programming types | Flash memory manufacturer | Target MCU | Sample Program (Word mode) | Example of file for Flash memory download*1 | Further note | Application Note |
|--|---------------------------|------------|----------------------------|---|---------------------|---------------------|
| JEDEC command type | Toshiba | H8S, H8SX | Download | Download | PDF | PDF |
| JEDEC command type (with initialization routine) | Toshiba | H8S, H8SX | Download | Download | PDF | |
| CUI command type | Renesas Technology | H8S, H8SX | Download | Download | PDF | |
| CUI command type (with initialization routine) | Renesas Technology | H8S, H8SX | Download | Download | PDF | |

E10A-USB Emulator information on the WEB

http://www.renesas.com/e10a_usb



[PRODUCTS](#) [APPLICATIONS](#) [SUPPORT](#)

Enter a Keyword

Enter a Part No.

[Parametric Search](#)

[Document Library](#)

[Home](#) / [Products](#) / [Software and Tools](#) / [Emulation and Debugging](#) / [On-chip Debuggers \(HW\)](#) /
E10A-USB

[Provide feedback](#)
[Print this page](#)

Here is a site for software version and support microcomputer information.

Here is a site for external flash memory download program.

Here is a site for Debug MCU Board.

Here is a site for HS0005ECK01H.



Here is a site for emulator related documents.

Here is a site for FAQ.

Here is a site for software version-up program.

- E10A-USB**
- Target Devices
- System Configuration
- Features
- Components
- Device Group Additions
- Specification
- Installation and Setup
- Flash Memory
- Download Program
- Debug MCU Board
- User interface cable for Micro 38pin connector
- Upgrade Information
- Documentation
- Application Notes
- FAQs
- Technical Update
- Downloads

Introduction

E10A-USB is a low-cost on-chip emulator from Renesas.

Previous E10A solutions have been based on either PCI or PCMCIA, and we E10A-USB works differently in that one hardware can support any HUP

E200F Emulator

E200F Supported Device Roadmap

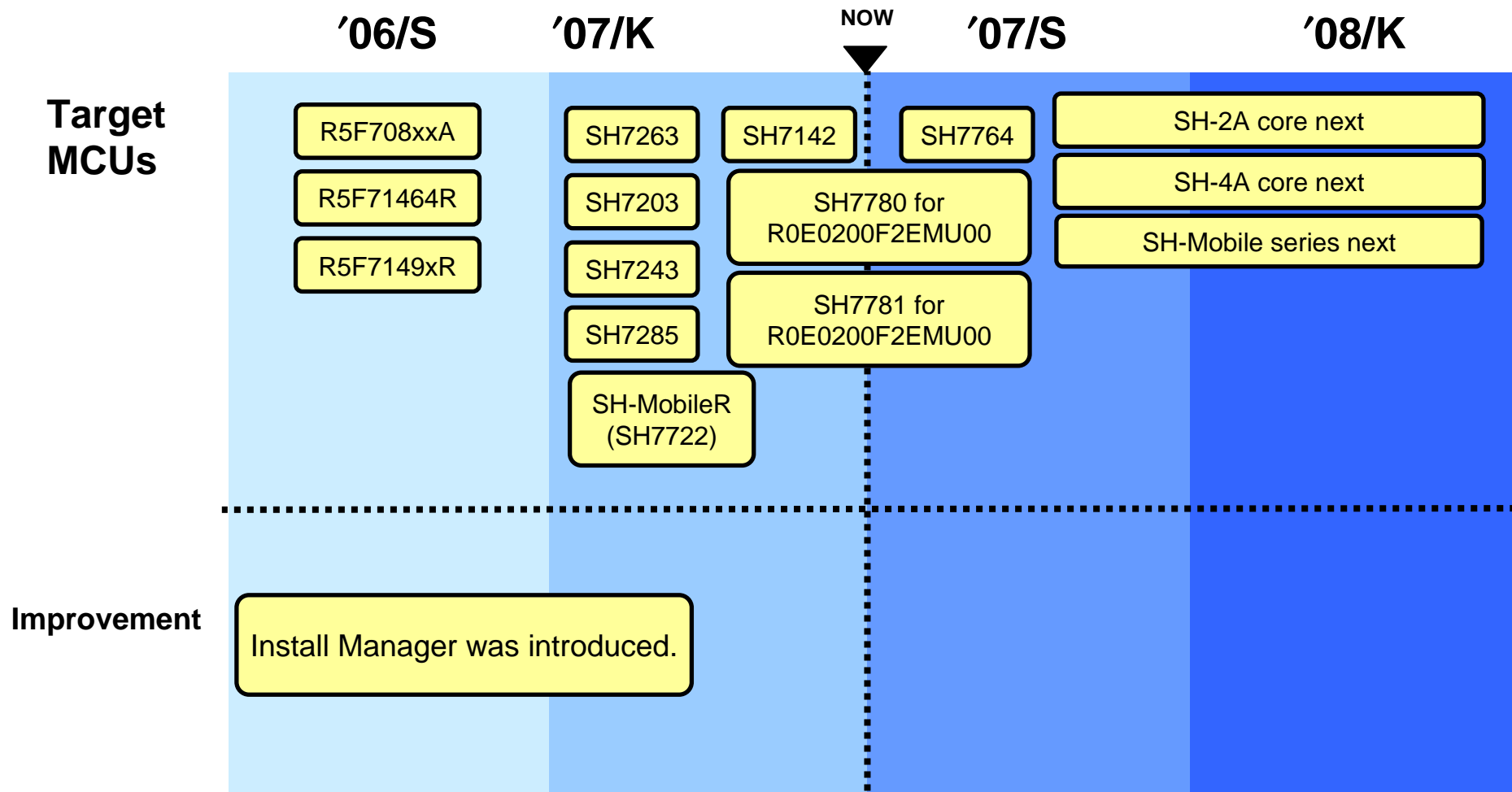

Feature of E200F

(1) Real time emulation

- The Real time emulation is available in the highest operation frequency of CPU and peripheral I/O.

(2) Break function

Hardware brakes

- Brake built in device: max 10 (differ by microcomputer)
- AUD brake: max 8 (differ by microcomputer)
- Bus brake (In case connecting external bus trace unit): 6

Software brake

- 1000 points

(3) Trace function

- CPU internal trace by AUD: 256 Kcycles in maximum
 - a) Branch address
 - b) Data in the specified memory area
 - c) Valuables that assigned to general registers
- External bus trace with optional "external bus trace unit": 256 Kcycles in maximum

(4) Performance analysis function (operate without stop program)

- Point-to-point measurement. Execution count measurement.
- Number of cache miss. Analyze system bus. Measure the number of CPU various event.

(5) Function of real time profile (operate without break the program)

- Time and pass count for each function

System Configuration of E200F (PC interface)

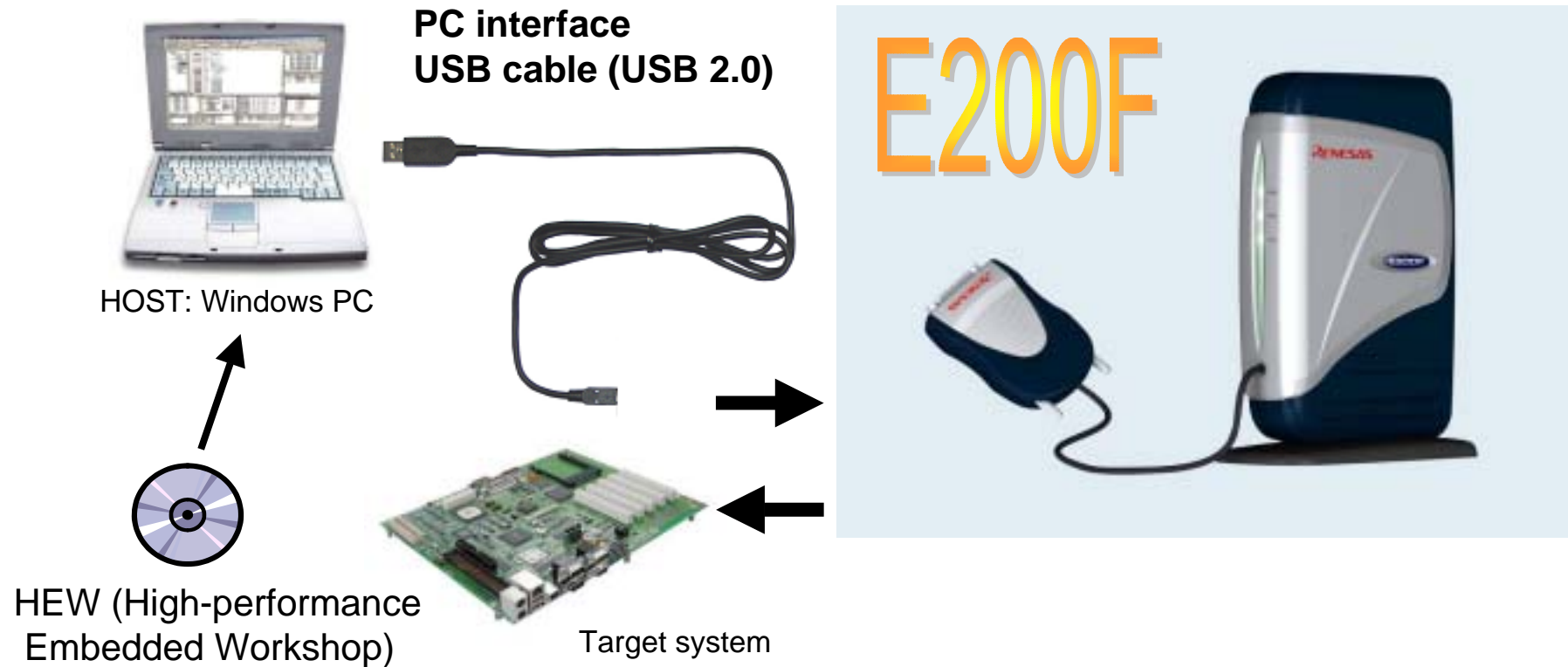

Notice: E10A-USB Emulator software for SH requires SuperH RISC engine C/C++ compiler package Ver.6 or later.
Microcomputer of SH-4A core and SH4AL-DSP core requires SuperH RISC engine C/C++ compiler package Ver.8 or later.
Microcomputer of SH-2A core requires SuperH RISC engine C/C++ compiler package Ver.9 or later.

E200F emulator for SH7785

- R0E0200F2EMU00 -

- **E200F full-spec emulator with enhanced debugging functions**

Achievement of 600-MHz trace

(AUD clock = 300 MHz, Double Data Rate).

The SSTL18 trace technology that is the new method of the AUD trace method is established.

- **Function of automatic adjustment of trace data**

The substrate design guideline etc. to the user system are only the routings with exactly the same wire-length, and impedance matches (50 Ω).

The function for the self adjustment of the trace timing when the emulator starts is provided.

It is possible to trace it always best according to this function of automatic adjustment.

- **New design in H-UID/AUD probe**

38-pin Mictor connector that is becoming an industry-wide standard is newly adopted and it corresponds to speed-up.

(2-767004-2 Tyco electronics AMP)

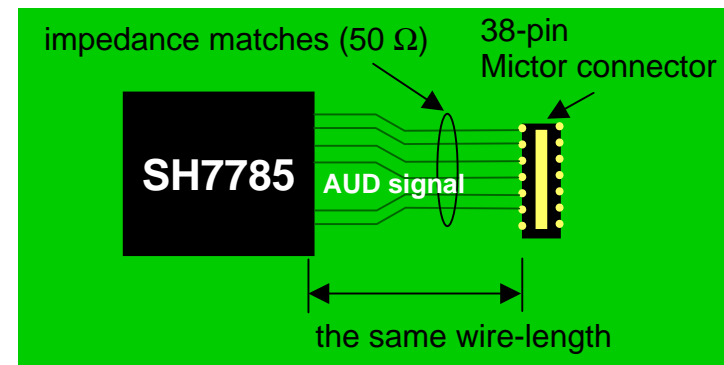

Function outline by product (1)

1. E200F main unit



1. E200F basic function is as same as E10A-USB.
The followings are the added function on the E10A-USB.
2. USB2.0 (High-speed communication with host PC)
USB1.1 (Full-speed communication with host PC)
3. 256-Kcycle trace acquisition.
4. Conditional trace is available by AUD trace information analyzing.
Trace start/stop, sequential condition match trace
5. Performance analyzing is available without break the program.
Performance channel: 4 in max (point to point, execution time measurement of the address range.)
6. Real-time profiling is available without break the program.
Performance profiling for each function.

2. External bus trace unit



1. Allows external bus trace
2. Burst ROM and DDR-SDRAM trace are not supported.

Function outline by product (2)

3. Evaluation chip unit



1. Allows debugging without user system.
2. Allows debugging using AUD for AUD nonsupport device.
3. Allows debugging using AUD for non-mounted H-UDI/AUD connector.
4. Evaluation chip unit is used with User interface board.

4. User interface board



1. User interface board is necessary to connect Evaluation chip unit to the user circuit board.
2. User interface board is different in the each package.
3. User interface board is connected to the IC socket of the user circuit board.

5. Trace cable



1. Trace cable connects E200F main unit and a Trace unit and Evaluation chip unit.
2. When two or more optional products are attached, only one trace cable can be used.

Function outline by product (3)

6. Expansion profile unit



1. Comparison with standard configuration

Real-time profile function

- Function measurement should be within the range of 12 MB (4 MB for standard component) from an AUD terminal output of the CPU.

Execution time of function

Number of the function calls

- Number of function counted: 60/20 k for standard configuration

7. Peripheral I/O analyzer unit



1. MFI bus trace and MFI terminal information analyzing are available when the debug target is an SH-Mobile Series CPU.

The hardware configuration of peripheral I/O analyzer unit for SH-Mobile3 is just ONE CABLE, without any boards.

8. Emulation memory unit (8 Mbytes/16 Mbytes)



1. Emulation memory (8 MB/16 MB)

E200F Emulator information on the WEB

<http://www.renesas.com/e200f>

The screenshot shows the Renesas website for the E200F emulator. At the top, there is a navigation bar with the Renesas logo and the tagline "Everywhere you imagine". To the right of the logo are links for "PRODUCTS", "APPLICATIONS", and "SUPPORT". Below the navigation bar is a breadcrumb trail: "Home / Products / Software and Tools / Emulation and Debugging / In-circuit Emulators (HW) / E200F".

On the left side, there is a vertical menu with the following items: "E200F" (with a right-pointing arrow), "Option Products", "Specification", "System Configuration", "Documentation", "Downloads", "FAQs", and "Options". Below this menu is a "Related Resources" section with a link to "ROE0200FOEMU00 Software Update V.1.06 Release 00 (SH7781 supported)".

On the right side, there is a large image of the E200F emulator hardware. Below the image is the heading "Target Devices" followed by a bullet point: "• SuperH RISC engine family".

Three callout boxes are overlaid on the screenshot:

- A red callout box pointing to the "E200F" menu item contains the text: "Here is a site for emulator related documents."
- A green callout box pointing to the "Downloads" menu item contains the text: "Here is a site for software version-up program."
- A red callout box pointing to the "FAQs" menu item contains the text: "Here is a site for FAQ."

MEMO

A large empty rectangular box with a black border, intended for writing a memo.

E10T-USB Emulator

Features and target device by E10T-USB

Features

- Debugging is enabled using the actual MCU on the user system
- The included USB interface makes the E10T-USB usable with either a laptop PC or desktop PC.
- Cheaper than full specification emulators
- Can also be used as the flash memory programming tool
- High-performance Embedded Workshop which runs on Windows® 2000 and XP is provided

Target device: H8/3048BF (F-ONE), H8/3029F
Type number: HS0005TCU01H

Caution

- Need the H8S, H8/300 C/C++ compiler package Ver.4 or later.

E10T-USB Emulator System Configuration

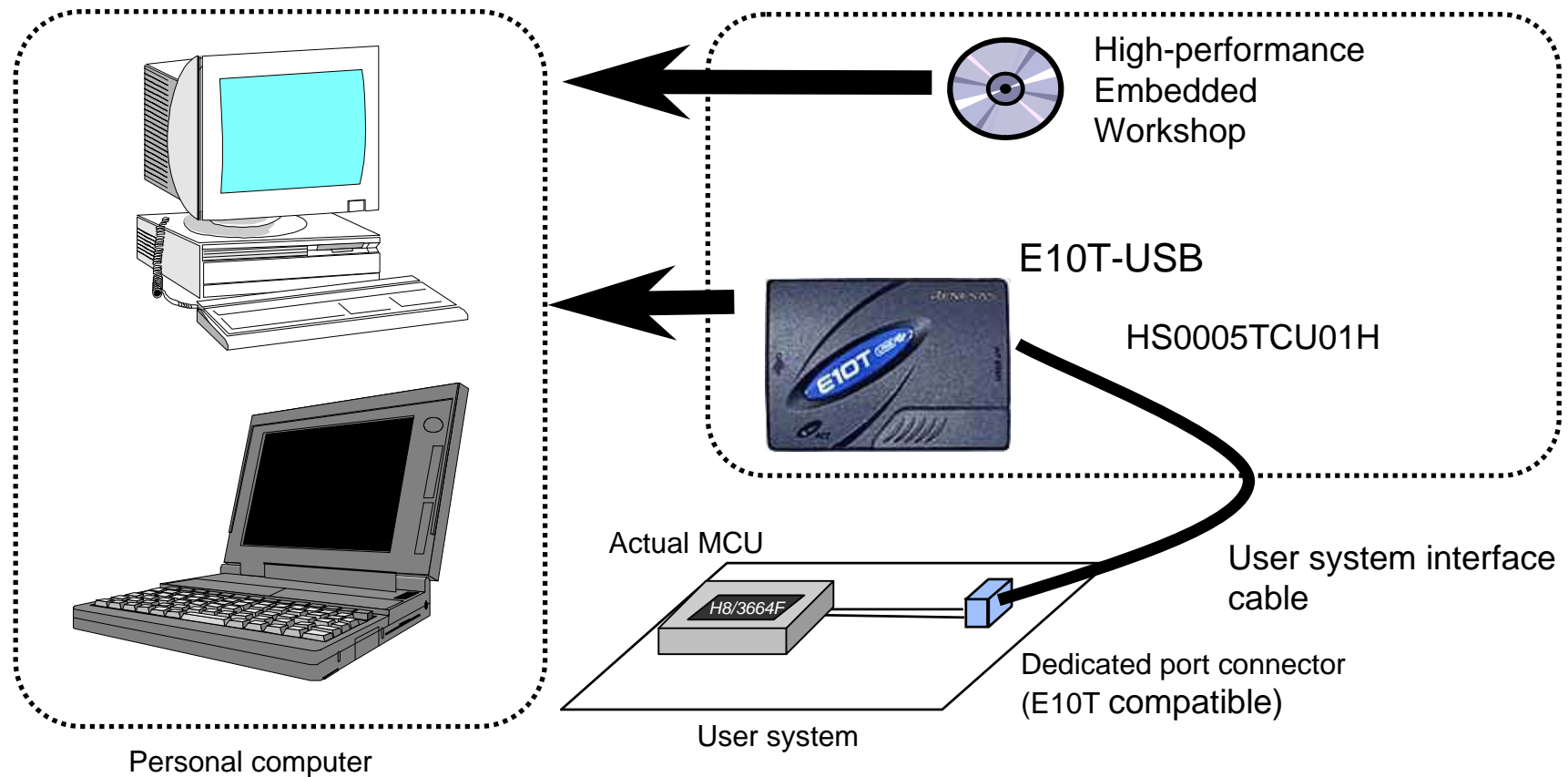

* The program must be downloaded to the internal flash memory.

E10T-USB Emulator information on the WEB

http://www.renesas.com/e10t_usb

The screenshot shows the Renesas website for the E10T-USB emulator. At the top, there is a navigation bar with the Renesas logo and tagline "Everywhere you imagine". The main navigation includes "PRODUCTS", "APPLICATIONS", and "SUPPORT". Search and part number entry fields are present. The breadcrumb trail reads: "Home / Products / Software and Tools / Emulation and Debugging / On-chip Debuggers (HW) / E10T-USB". A "Full Product Info" button is visible on the right. A left-hand menu lists categories: "E10T-USB" (with a plus sign), "Bundled Software", "Components", "Features", "Specifications", "System Configuration", "Upgrade Information", "Documentation", "Downloads", "FAQs", and "Technical Update". A "RELATED RESOURCES" section is partially visible. The main content area features an image of the E10T-USB emulator, a "Target Devices" list containing "H8/3048F-ONE(H8/3048BF, H8/3048BVF), H8/3029F", and options to "Provide feedback" and "Print this page".

Region: GLOBAL 日本 | 서울 | 上海 | 臺北 MY RENESAS COMPANY INFO NEWS & EVENTS CONTACT US

RENEASAS
Everywhere you imagine

PRODUCTS APPLICATIONS SUPPORT

Enter a Keyword GO Enter a Part No. GO

Parametric Search Document Library

Home / Products / Software and Tools / Emulation and Debugging / On-chip Debuggers (HW) /
E10T-USB

Provide feedback
Print this page

Full Product Info

E10T-USB +

- Bundled Software
- Components
- Features
- Specifications
- System Configuration
- Upgrade Information

Documentation

Downloads

FAQs

Technical Update

RELATED RESOURCES

E10T-USB

Target Devices

- H8/3048F-ONE(H8/3048BF, H8/3048BVF), H8/3029F

Here is a site for emulator related documents.

Here is a site for software version-up program.

E8a Emulator **New Release**

E8a Emulator System Configuration

Development environment is unified to previous emulator debuggers.

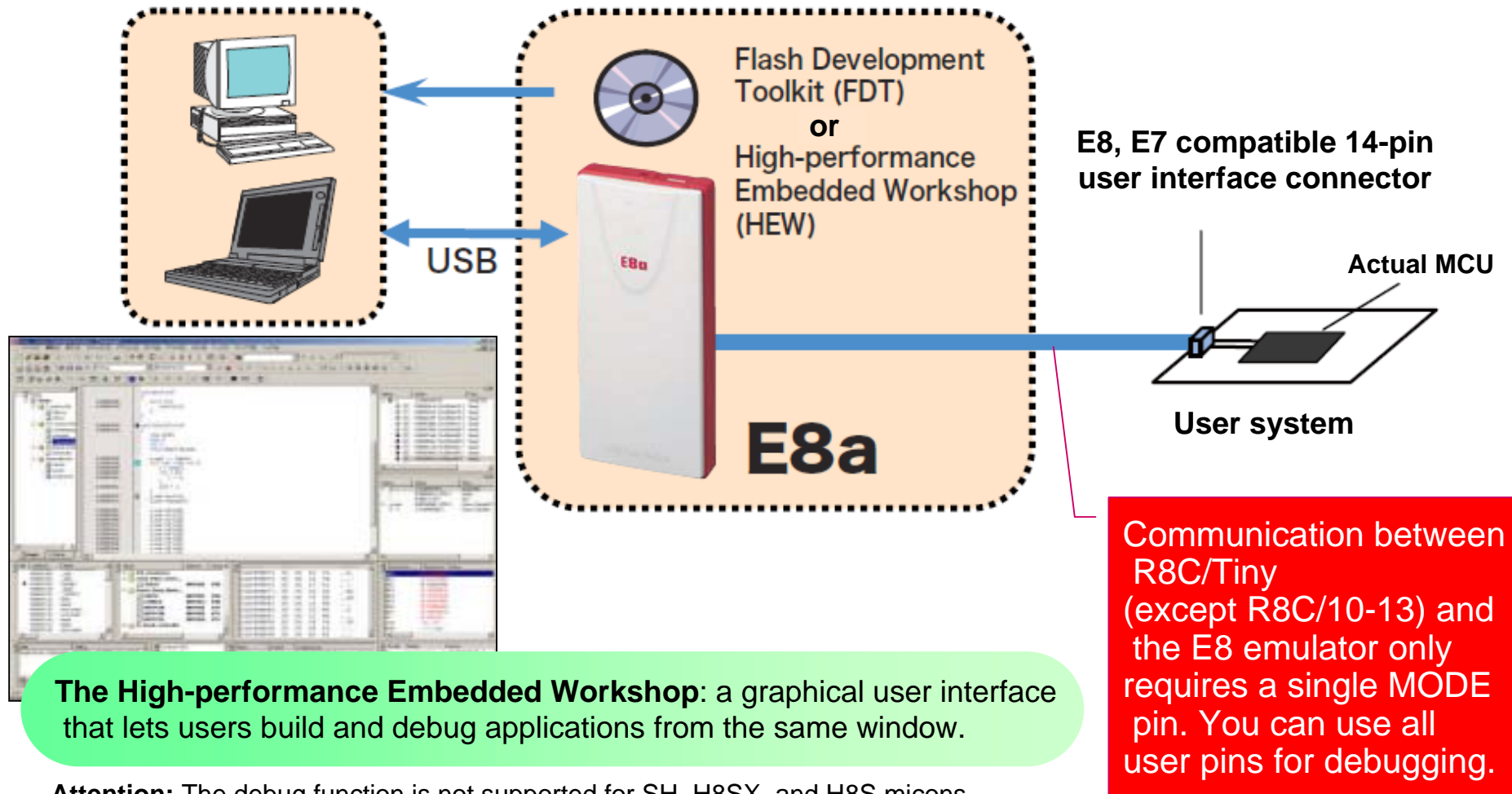

E8a Supported Device Roadmap

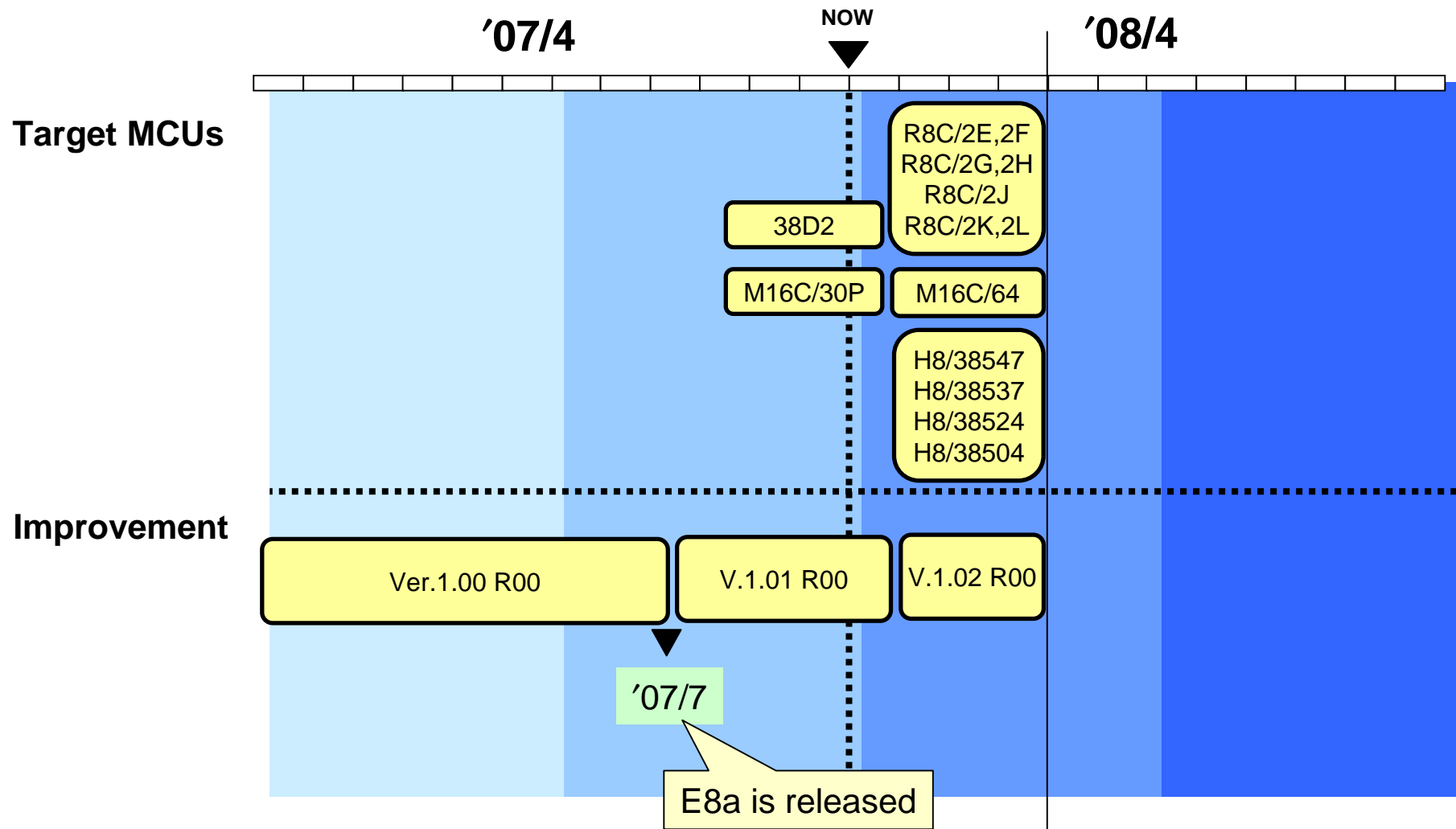

Features of the E8a emulator

- **E8a Emulator is an on-chip debugger and is a flash memory programmer also.**

Reasonably priced and packed with special features, E8a products fully support speedy market-entry for the low-cost system products. Not only sophisticated various debug features with High-performance Embedded Workshop, E8a offers flash memory programming features by using Flash Development Toolkit.

- **Applicability of programming function for on-chip flash memory extended to all Renesas microcontroller families**

E8a Emulator's programming function for on-chip flash has been extended to cover previously unsupported Renesas products, such as SuperH™ Family and H8S Family microcontrollers. But, you need the FDT Ver.4 or upper version to use this function.

- **Use of environment-friendly materials**

With the environment in mind, vegetable-based polylactide, a biodegradable plastic material, is used for the case. And also, the E8a emulator uses a lead-free design.

- **New design offering ultra-compact dimensions**

The new design features Renesas Technology's trademark red color-based and offers ultra-compact dimensions of 92 mm × 42 mm × 15 mm. The E8a Emulator has been reduced in volume to approximately 40% that of the E8 Emulator while inheriting its emulation functions and ease of use.

NEW State of Support for MCUs by the E8a Emulator (as a Programming Tool)

- The combination of the E8a emulator and development toolkit (Flash Development Toolkit V.4.00) enables on-board programming. This combination can support SH, H8SX, and H8 Family MCUs with flash memory that are not supportable by the E8 emulator.
- Refer to the following URL for details of the MCUs supported by the E8a emulator and version 4.00 of the Flash Development Toolkit.
http://www.renesas.com/media/products/tools/flash_prom_programming/flash_development_toolkit/ver_4/rej10j1669_flashtoolkit_s.pdf

- Note: 1. The programming of 740 Family products (QzROM versions) requires an IC socket board. Boards for some other products are under development. Refer to the *Schedule of Main Tool Products* on the RSSI site for the schedule.
2. The E8a emulator cannot be used in the debugging of SH and H8SX Family products. When this is required, the E10A-USB on-chip debugging emulator must be used instead of the E8a.

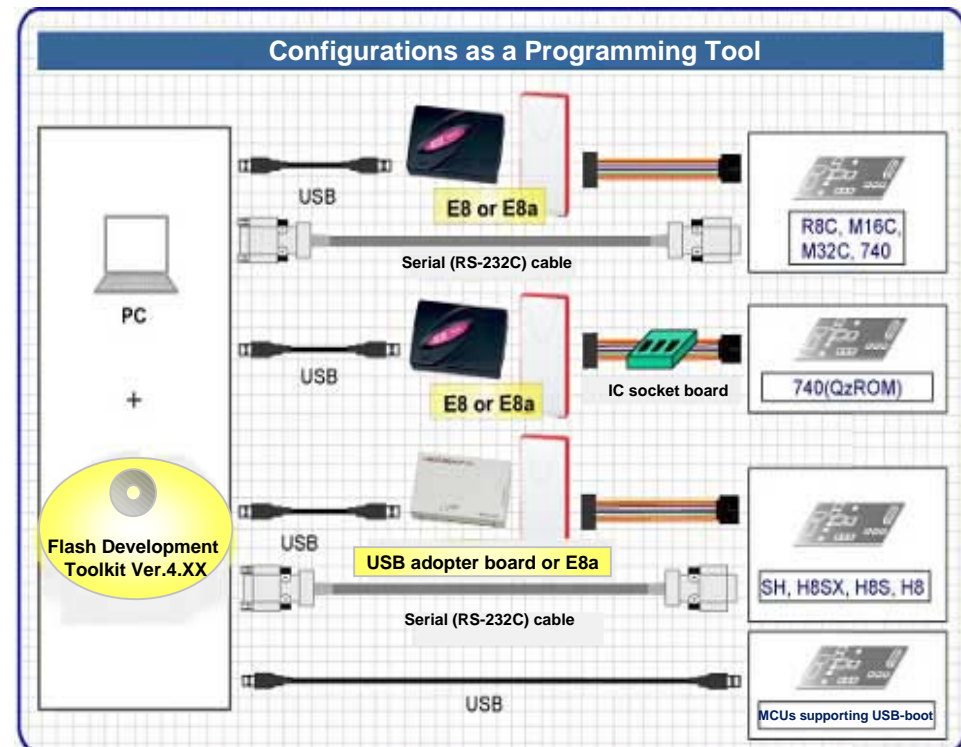

NEW Changes and Additions to Functions (1)

Better Usability!

740 R8C M16C M32C H8

- The macro function can be used to set break events.

This command enables recording of the operation of setting break events.

Better Usability!

H8

- Break event settings can be tracked in source files in the same way as software break settings. Setting information are saved with the session. Therefore, the break event settings can be recovered automatically on the next start-up.

Better Usability!

740 R8C M16C M32C

- Improved methods of selecting MCUs.

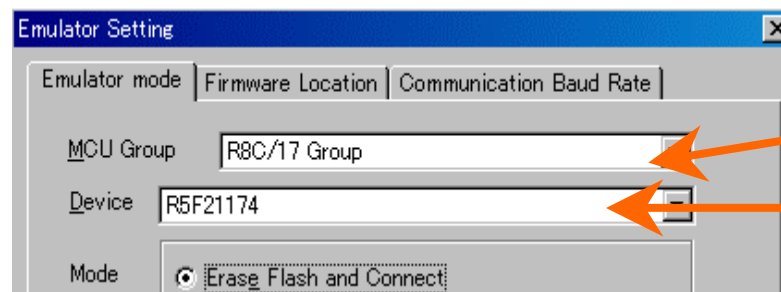

① Application of group names to extract MCUs

② Selection of device part numbers.

NEW Changes and Additions to Functions (2)

Better Usability!

R8C M16C M32C

- Event breaks can now be set during program execution.

Better Usability!

H8

- The frequency input dialog box is not displayed for MCUs with fixed communications frequencies.

Better Functionality!

740 R8C M16C M32C

- “Debugging in the CPU programming mode” has been added as a dedicated mode for the debugging of programs that apply the CPU programming mode.

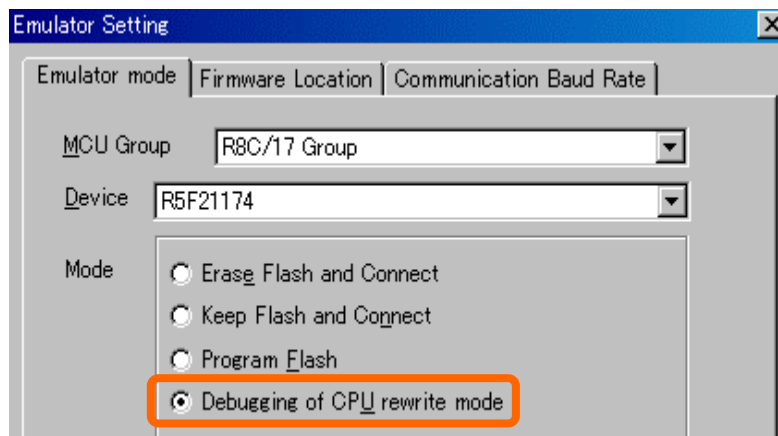

Conventional (Flash memory to PC)

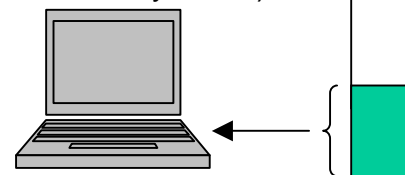

A break might take time because data are read from all areas.

New mode

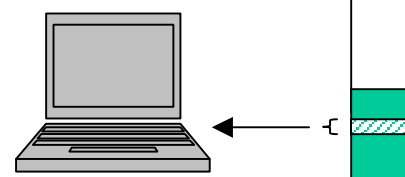

A break does not take time because data are only read from the necessary areas. However, software breaks and changing an area of flash memory in the memory window are not possible.

NEW Changes and Additions to Functions (3)

Better Functionality!

*Not supported for the R8C/10 to 13 Groups.

R8C M16C M32C

- A start/stop function has been added, allowing the execution of routines specified by the user immediately after the user program is stopped or immediately before it starts. The user can thus have the selected functions run when the program stops because of a break or is restarted after a break, etc.

1. Specify a user routine to be executed immediately before execution of the user program starts (immediately after the “Execute” button is clicked).
2. Specify a user routine to be executed immediately after the user program is stopped (immediately after the “Stop button” is clicked and immediately after a break condition is matched to stop the program).

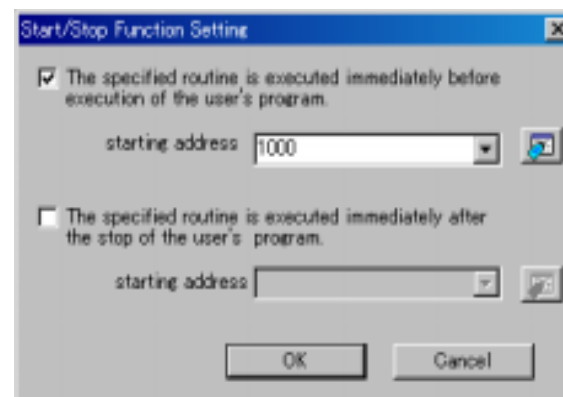

The specifications for the indicated routines include restrictions. If these restrictions are not observed, the emulator may not operate properly. Be sure to read the user's manual before using the software.

Better Functionality!

740 R8C M16C M32C

- Control signals (e.g. reset) used by the E8a emulator are cleared after the end of programming, and the execution of a user program can be selected in the flash-memory programming mode. However, this is only selectable when power is not being supplied by the E8a emulator.

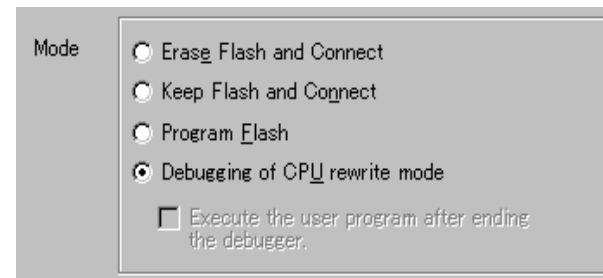

E8a Emulator information on the WEB

http://www.renesas.com/e8a

The screenshot shows the Renesas website for the E8a emulator. The top navigation bar includes the Renesas logo, 'PRODUCTS', 'APPLICATIONS', and 'SUPPORT'. Search fields for 'Enter a Keyword' and 'Enter a Part No.' are present. The breadcrumb trail reads: Home / Products / Software and Tools / Emulation and Debugging / On-chip Debuggers (HW) / E8a. A 'Full Product Info' button is visible. A left sidebar menu lists: E8a, Components, Specifications, System Configuration, Features, Flash Memory, Programming, Switchover from E8 to E8a, Upgrade Information, Documentation, FAQs, Downloads, Options, and Purchasing Info. The main content area features an image of the E8a emulator and a 'Target Devices' list: M16C Family (M32C/M16C/R8C), H8 Family H8/Tiny Series, H8 Family H8/Super Low Power Series, 740 Family, SuperH Family *, H8SX Family *, and H8S Family *.

Here is a site for emulator related documents.

Here is a site for software version-up program.

Here is a site for switchover from E8 to E8a

MEMO

A large empty rectangular box with a black border, intended for writing a memo.

E6000 Emulator

E6000 System Configuration

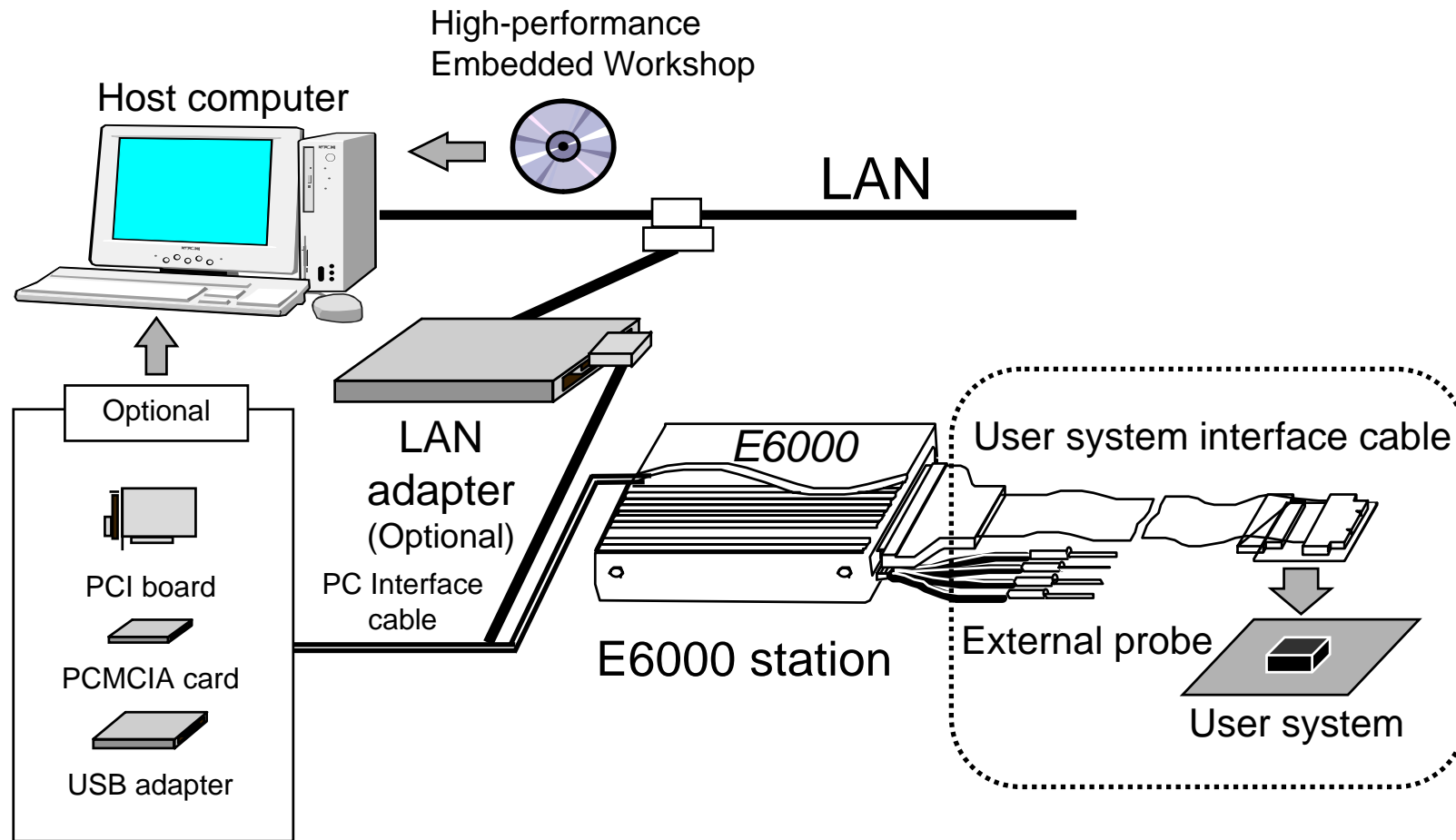

Attention: Two or more E6000s cannot be used at the same time when connecting them with one PC by using USB interface.

Features of the E6000

- Compact size
 - 220 × 160 × 57 mm
- Oscillation circuit at the end of the user system interface cable
- Easy-to-use debugging functions due to environment supporting Windows® (Windows® 2000 or XP)
Since the High-performance Embedded Workshop is supported, the debugging and the build can be performed in the same window.
Need the H8S, H8/300 C/C++ compiler package Ver.4 or upper version.
- Software development efficiency improved by C-source level debugging functions (applicable to optimized programs as well)
- Break and trace trigger using the event detection circuit
 - Input condition: Address bus, data bus, R/W, and external probe etc.
 - Count of events: Delay-count specification function
 - Sequential specification function
 - Event interval time measurement function
- Break functions
 - Software break: 256 points
 - Hardware break: 12 points max.
- Trace modes
 - Free trace, range trace, filter, suppress, trace stop, time stamp and delayed stop

Options of the E6000

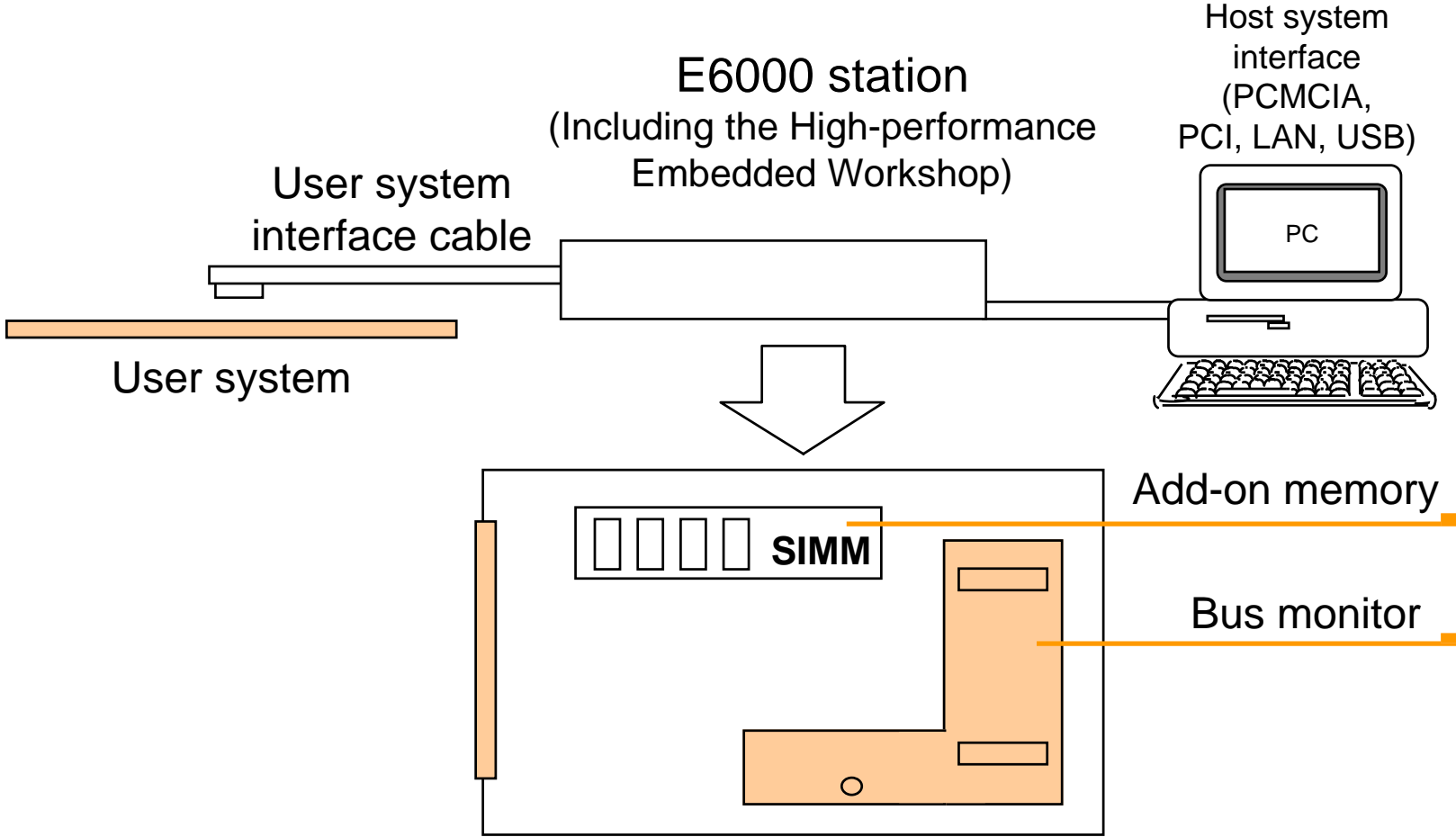

Note: The bus monitor is provided as standard or optional depending on the supported MCU.

E6000 Optional I/O Board

Type 1

Inserted into the E6000 emulator station

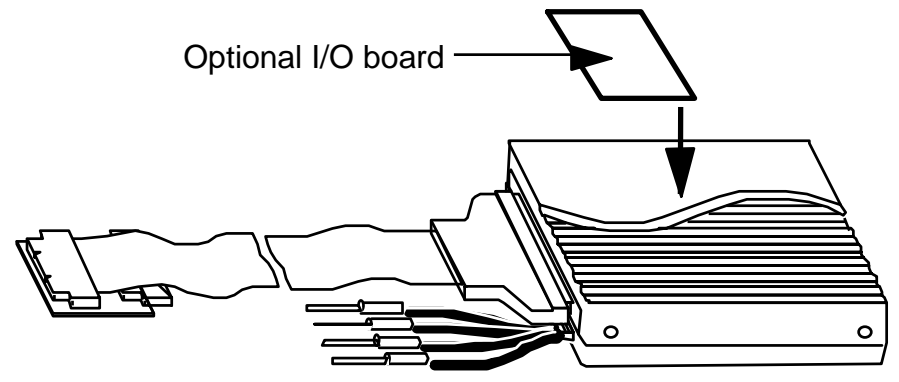

Type 2

Connected between the E6000 emulator station and the user cable

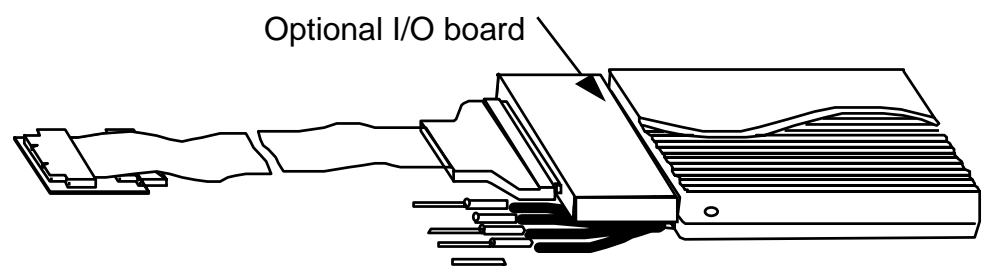

Type 1 Optional board list

| Supported device | Optional I/O board | E6000 emulator |
|------------------|-----------------------|----------------|
| H8S/2258 Group | HS2258EIO61H (IEBus™) | HS2633EPI61H |

Type 2 Optional board list

| Supported device | Optional I/O board | E6000 emulator |
|-----------------------|-------------------------------------|-----------------------------|
| H8S/2140B | HS2140EIO61H (LPC board) | HS2140EPI61H |
| H8S/2160B | HS2160EIO61H (LPC board) | |
| H8/3857 Group | HS3857EIO60H (Expansion board) | HS3L08EPI60H + HS3834EVI60H |
| H8/3854 Group | HS3854EIO60H (Expansion board) | |
| H8/3937 | HS3937EIO60H (FLEX™ decoder board) | HS388REPI60H |
| H8/3937R | HS3937REIO60H (FLEX™ decoder board) | |
| H8/36057, 36037 Group | HS36037EIO61H (H-CAN board) | HS3664EPI62H |
| H8/36024 Group | HS36024EIO61H (Serial board) | |
| H8/36049 Group | | |
| H8/36912 Group | | |
| H8/36902 Group | | |
| H8/36109 Group | HS36109EIO61H (Serial board) | HS3664EPI62H |

E6000 Emulator information on the WEB

<http://www.renesas.com/e6000>

The screenshot shows the Renesas website for the E6000 emulator. At the top, there is a navigation bar with the Renesas logo and the tagline "Everywhere you imagine". The main navigation includes "PRODUCTS", "APPLICATIONS", and "SUPPORT". There are search boxes for "Enter a Keyword" and "Enter a Part No.", along with "Parametric Search" and "Document Library" links. The breadcrumb trail reads: "Home / Products / Software and Tools / Emulation and Debugging / In-circuit Emulators (HW) / E6000". A "Full Product Info" button is visible on the right. On the left, a sidebar menu lists: "E6000", "Specifications", "System Configuration (LAN)", "System Configuration (PCI)", "System Configuration (PCMCIA)", "System Configuration (USB)", "Documentation", "Downloads", "FAQs", "Options", and "Technical Update". A large image of the E6000 emulator hardware is shown in the center. Two yellow callout boxes are present: one pointing to the "Documentation" link in the sidebar with the text "Here is a site for emulator related documents.", and another pointing to the "Downloads" link with the text "Here is a site for software version-up program."

Compact emulator for H8/300H Tiny series

Features

Despite being small, the compact emulator incorporates rich debugging functionality, including real-time tracing, making it competitive with full-spec. emulators. Also, it is a low-price emulator.

- **Compact design and low price**

Much smaller main unit than conventional emulator system. Low price due to mounting frequently-used functions only.

- **Includes a set of development tools**

(integrated development environment, compiler, and debugger)

Function-limited cross software tool is also included with emulator main unit, enabling the development and debugging of application programs immediately after purchase.

When H8 device is used, need the H8S, H8/300 C/C++ compiler package Ver.4 or upper version.

- **Rich debugging functionality**

Though low-priced, this emulator incorporates functions necessary for actual development.: Real-time trace, hardware break, and real-time RAM monitor, etc.

- Prepare a power supply which complies with CE marking requirements separately. (Spec. 5.0 V \pm 5% (DC))
The power cable is included with this product.



Compact emulator for the H8/300H Tiny series

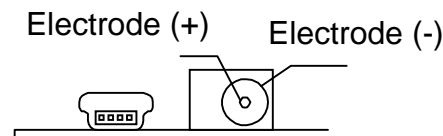

Power connector specifications

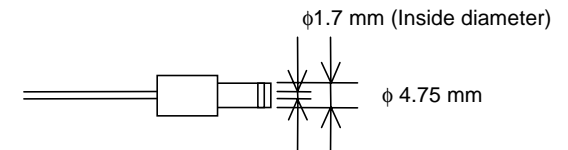

Applicable plug specifications

Function Comparison: Compact and Full-Spec Emulators for H8/300H Tiny Series (Reference)

| Function | Compact Emulator R0E436640CPE00 | Full-spec Emulator E6000 |
|--------------------------------|--|---|
| MCU mode | Single-chip mode | Single-chip mode |
| Emulation memory | External SRAM | External SRAM |
| Software breakpoints | 64 points | 256 points |
| Hardware break | 2 points (switchover with trace point) Prefetch/access | 12 points (shared with trace point) Prefetch/access PC break |
| Combination of hardware breaks | AND/OR/Synchronous AND Bus count: 255 times | AND/OR/sequential (Maximum 8 levels) Bus count: 65,535 times |
| Exception detection | — | Write protected break Guarded area break |
| Real-time trace | 64 Kcycles Address, data, read/write cycle, memory area types, status Whether to write or not when an event occurs | 32 Kcycles Address, data, read/write cycle, memory area types, status, external interrupt signals, 4 external probes, specified address data, time stamp |
| Trace mode | Free/full/point | Free/point |
| Real-time RAM monitor | 1 KB (256 B × 4 blocks) data/last access | 2 KB (256 B × 8 blocks) data/final access |
| Time measurement | Max. 30 hrs (100 ns) between program execution and program stop. | Max. 4800 hrs between program execution and program stop (setting up resolution variable). |
| Performance | — | Max. execution time measurement: 8 Max. subroutine execution measurement: 65,535 |
| Coverage | — | — |
| Trigger output | — | 2 |
| External trigger input | — | 4 |
| I/F between hosts | USB interface (USB1.1, Full speed)* | PCI/PCMCIA/LAN (optional) USB interface (USB1.1, Full speed)* |
| Dimensions | 96.0 × 60.0 × 37.8 mm | 219.0 × 170.0 × 54.0 mm |

*: Can be connected to USB2.0 supporting host device

Compact Emulator Support Groups for the H8/300H Tiny Series

- Bundled with accessory (by MCU package) and compact emulator body

| MCU group | package type | package number | type number | product component |
|---|---------------------------------|--------------------------|----------------|--|
| H8/3664, H8/3694 H8/3687, H8/36064 H8/36087, H8/36079* H8/36077*, H8/36094* | 64-pin and 0.8-mm-pitch QFP | PRQP0064GB-A (FP-64A) | R0E436640CPE10 | Compact emulator body R0E436640CPE00 and conversion board for 64-pin and 0.8-mm-pitch QFP (FP-64A) R0E436640CFG20 |
| H8/3664, H8/3694 H8/3672, H8/36014 H8/3687, H8/36064 H8/36087 H8/36079*, H8/36077* H8/36094* | 64-pin and 0.5-mm-pitch LQFP | PLQP0064KC-A (FP-64E) | R0E436640CPE20 | Compact emulator body R0E436640CPE00 and conversion board for 64-pin and 0.5-mm-pitch LQFP (FP-64E) R0E436640CFK20 |
| H8/36049 | 80-pin and 0.65-mm-pitch QFP | PRQP0080JB-A (FP-80A) | R0E436049CPE10 | Compact emulator body R0E436640CPE00 and conversion board for 80-pin and 0.65-mm-pitch QFP (FP-80A) R0E436049CFJ10 |

*: New product

- Separate sales for compact emulator body and conversion board

| Type number | Product component |
|----------------|---|
| R0E436640CPE00 | Compact emulator body for H8/300H Tiny series |
| R0E436640CFG20 | Conversion board for PRQP0064GB-A (64-pin and 0.8-mm-pitch QFP (FP-64A)) |
| R0E436640CFK20 | Conversion board for PLQP0064KC-A (64-pin and 0.5-mm-pitch LQFP (FP-64E)) |
| R0E436049CFJ10 | Conversion board for PRQP0080JB-A (80-pin and 0.65-mm-pitch QFP (FP-80A)) |

Compact Emulator Support Groups for the H8/300H Tiny Series information on the WEB

<http://www.renesas.com/cpe>

Click “R0E436640CPE00” to see information of compact emulator support group for the H8/300H Tiny Series

Here is a site for emulator related documents.

Here is a site for software version-up program.

The screenshot shows the Renesas website interface. The main navigation includes 'PRODUCTS', 'APPLICATIONS', and 'SUPPORT'. The breadcrumb trail is 'Home / Products / Software and Tools / Emulation and Debugging / Compact Emulators (HW)'. A list of compact emulators is shown, with 'R0E436640CPE00' circled in red. A yellow callout box highlights this product, and a yellow speech bubble points to it with the text 'Click “R0E436640CPE00” to see information of compact emulator support group for the H8/300H Tiny Series'. Another yellow speech bubble points to the 'Downloads' section of the product page with the text 'Here is a site for software version-up program.' A third yellow speech bubble points to the 'Documentation' section of the product page with the text 'Here is a site for emulator related documents.'

MEMO

E6000H Emulator

E6000H Roadmap

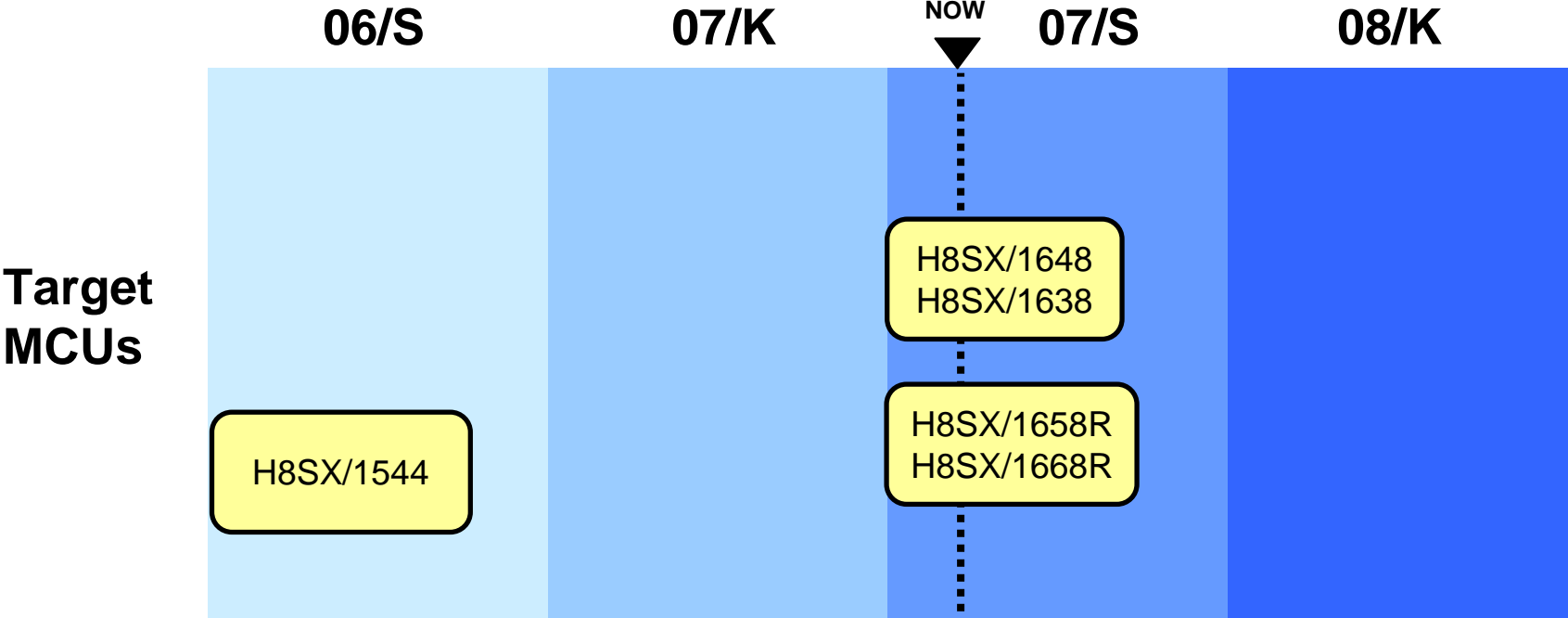

System Configuration of the E6000H Emulator

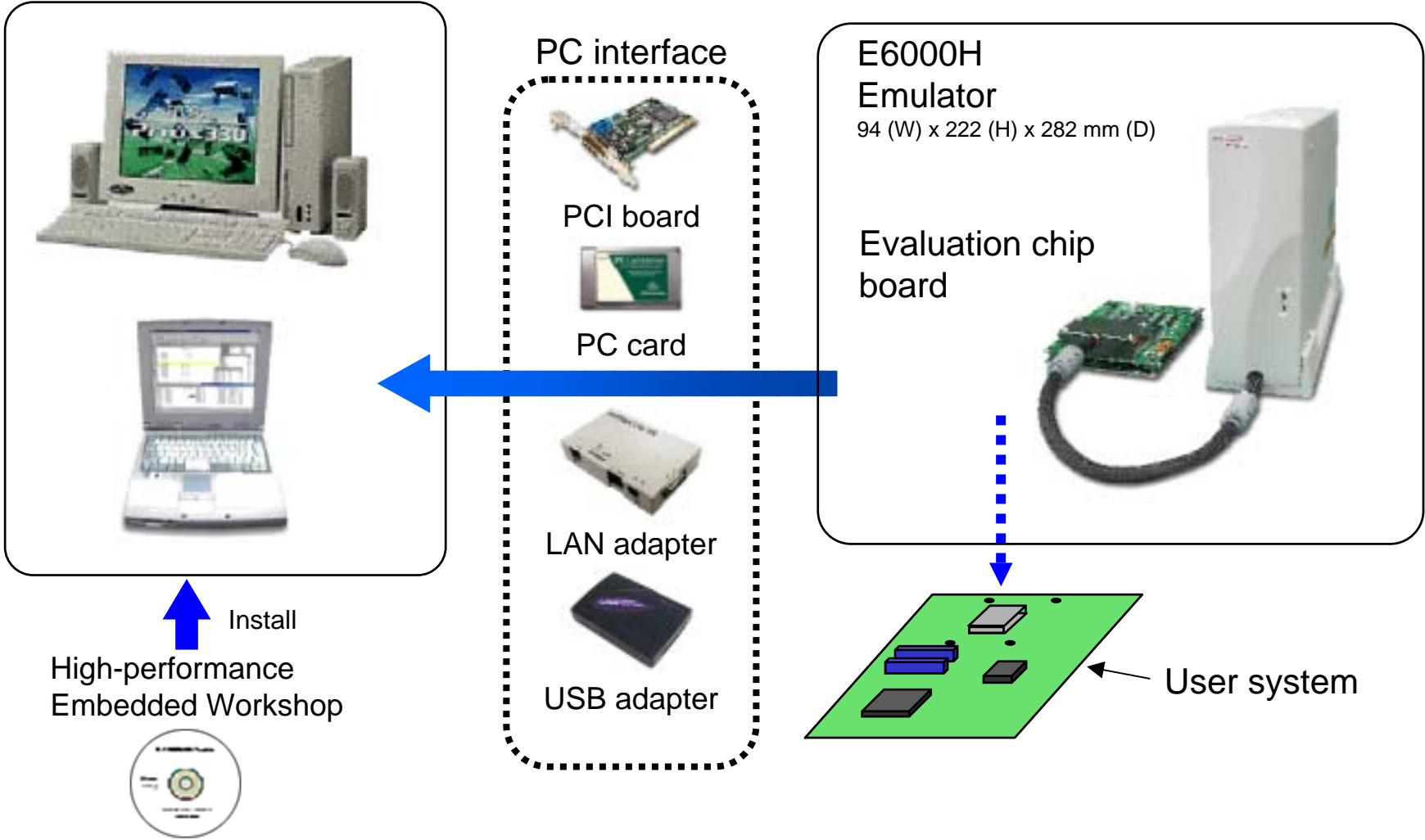

Features of the E6000H Emulator

- **Real time emulation**
 - Real-time emulation enabled at the chips internal and external maximum frequency (max. 100 MHz)
- **Break functions**
 - Hardware breaks: Can be set to max 4 independently + UBC break
 - Software breaks: max 255 points
- **Trace function**
 - Trace capacity: 128 bits x 128-K bus cycles
 - Trigger points: max 8
- **Performance function**
 - Subroutine execution count measurement module: max 8
 - Real-time watch function
- **Supports multiple platforms**
 - Windows® 2000 and Windows® XP
- E6000H Emulator software for H8SX requires H8S, H8/300 C/C++ compiler package Ver.6 or later.
- E6000H Emulator software for SH requires SuperH RISC engine C/C++ compiler package Ver.6 or later.

E6000H Product Lineup and Supported Devices

*: Under development

| Target device | E6000H main unit | User system interface | |
|----------------------------------|---|---|---|
| SH7059 | HS7059EPH60H | HS7058ECF61H (PRQP0256KB-A (Previous code FP-256H)) | |
| SH7058S | | HS7058ECB61H (- (Previous code BP-272)) | |
| SH7058 | HS7058EPH60H | HS7058ECF61H (PRQP0256KB-A (Previous code FP-256H)) | |
| | | HS7058ECB61H (- (Previous code BP-272)) | |
| SH7046, SH7048 SH7148, SH7101 | HS7046EPH60H | HS7046ECH61H (PRQP0080JD-A (Previous code FP-80Q)) | |
| SH7047, SH7049 | | HS7047ECH61H (PRQP0100KB-A (Previous code FP-100M)) | |
| SH7144 | | HS7144ECH61H (PRQP0112JB-A (Previous code FP-112B)) | |
| SH7145 | | HS7145ECH61H (PLQP0144KB-A (Previous code FP-144F)) | |
| H8SX/1650, 1657 | | HS1650EPH60H | HS1650ECN61H (PTQP0120LA-A (Previous code TFP-120)) |
| H8SX/1653 | | | HS1653ECN61H (PTQP0120LA-A (Previous code TFP-120)) |
| H8SX/1654 | | | |
| H8SX/1663 | HS1664ECH61H (PLQP0144KA-A (Previous code FP-144L)) | | |
| H8SX/1664 | | | |
| H8SX/1651 | HS1651ECN61H (PLQP0120LA-A (Previous code FP-120B)) | | |
| H8SX/1622 | HS1622ECH61H (PLQP0144KA-A (Previous code FP-144L))* | | |
| H8SX/1638 | HS1638ECN61H (PLQP0120LA-A (Previous code FP-120B))* | | |
| H8SX/1648 | HS1648ECH61H (PLQP0144KA-A (Previous code FP-144L))* | | |
| H8SX/1658R | HS1658RECN61H (PLQP0120LA-A (Previous code FP-120B))* | | |
| H8SX/1668R | HS1668RECH61H (PLQP0144KA-A (Previous code FP-144L))* | | |
| H8SX/1525, 1527 | HS1527KEPH60H | HS1527ECH61H (PRQP0100KB-A (Previous code FP-100M)) | |
| H8SX/1582 | | HS1582ECH61H (PLQP0120LA-A (Previous code FP-120B)) | |
| H8SX/1527R | HS1527REPH60H | HS1527ECH61H (PRQP0100KB-A (Previous code FP-100M)) | |
| H8SX/1544 | HS1544EPH60H | HS1544ECH61H (PLQP0144KA-A (Previous code FP-144L)) | |

User System Interface (Except HS1527ECH61H, HS1582ECH61H, HS1544ECH61H)

Connection with the Dedicated Connectors

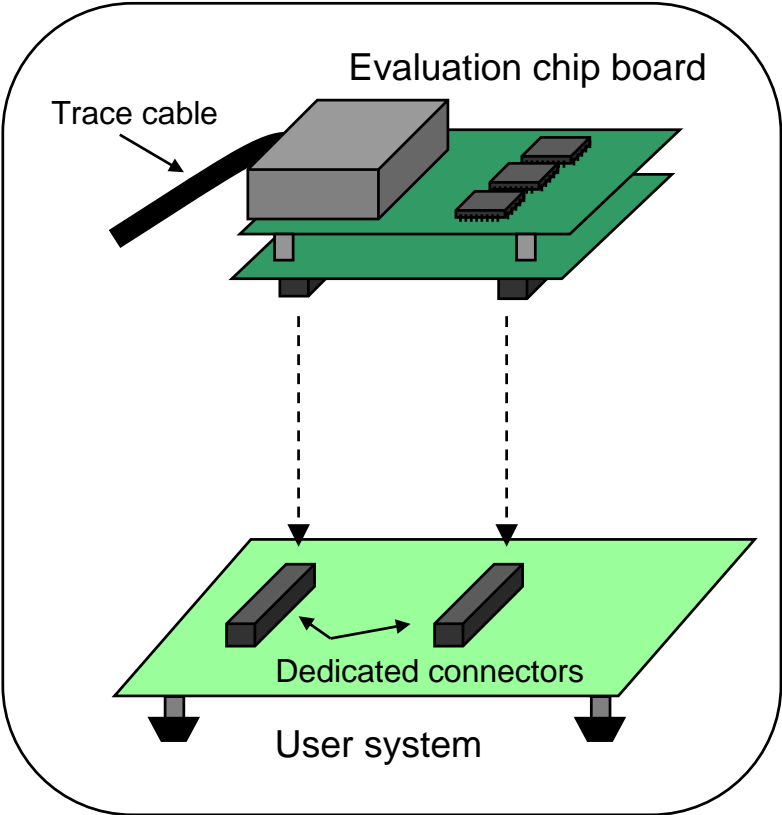

Connection with the IC Socket

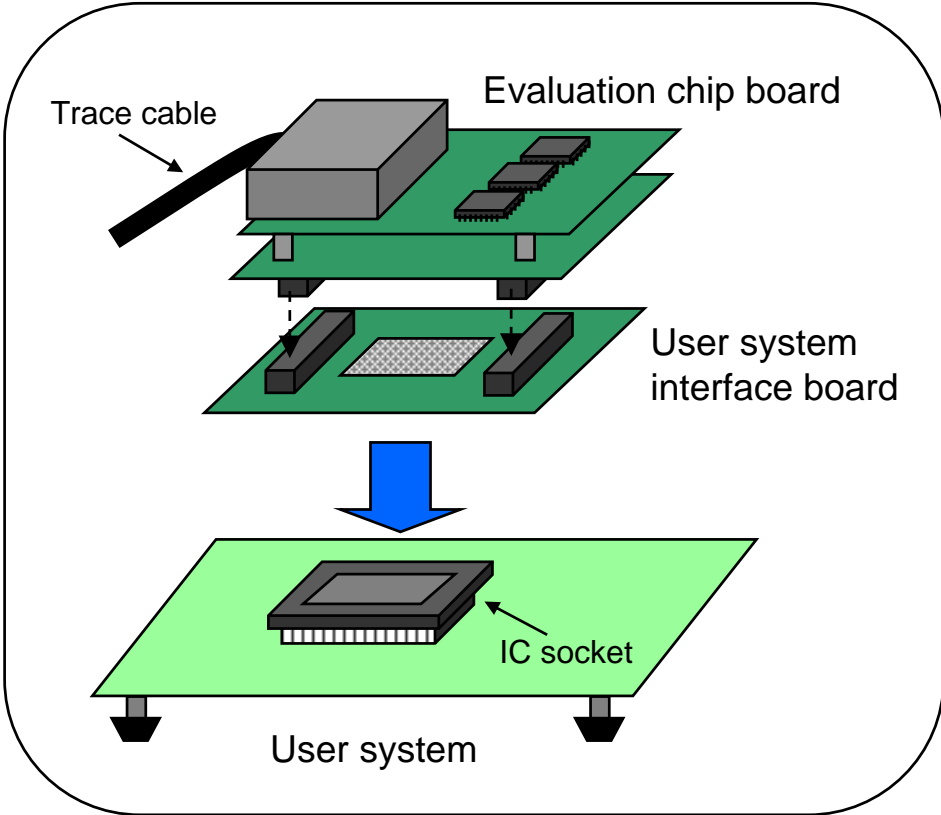

User System Interface (HS1527ECH61H, HS1582ECH61H, HS1544ECH61H)

Connection with the IC Socket

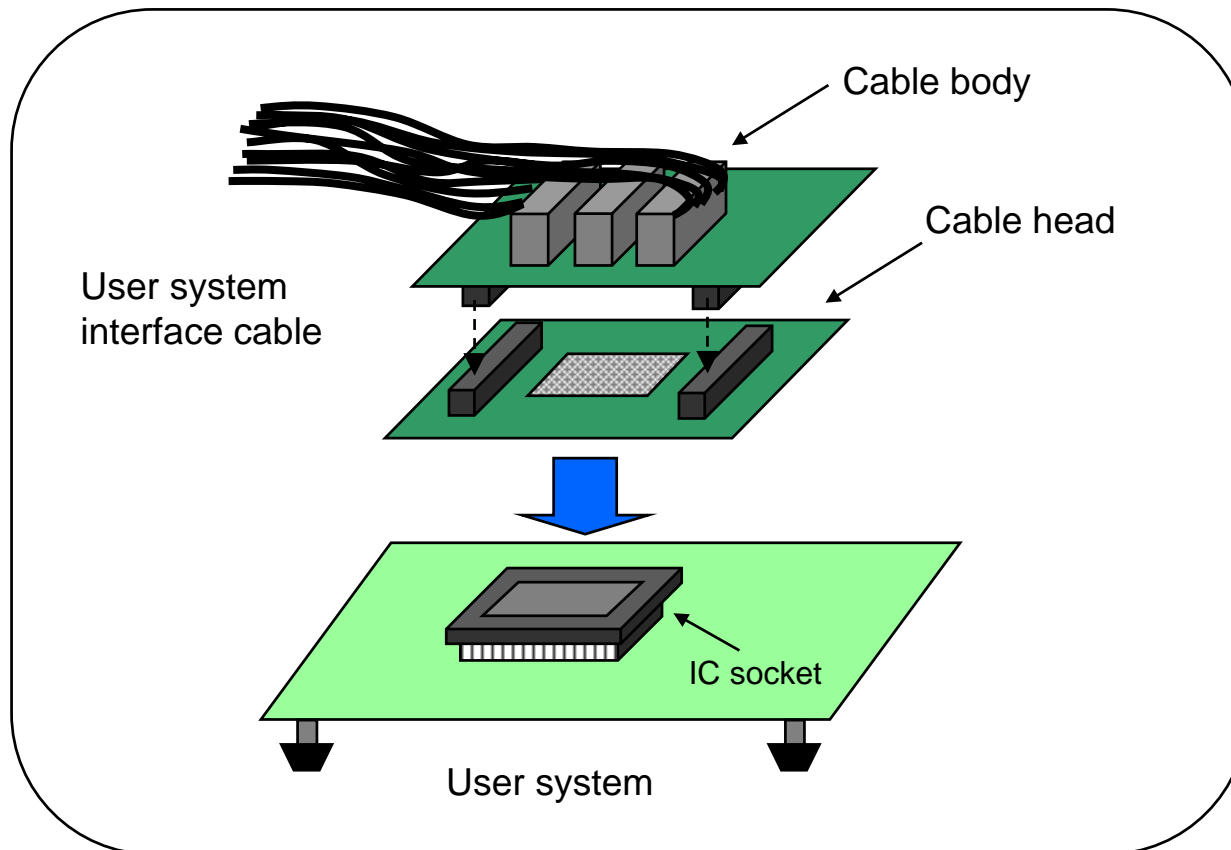

E6000H Emulator information on the WEB

<http://www.renesas.com/e6000h>

The screenshot shows the Renesas website for the E6000H emulator. The page features a navigation bar with the Renesas logo and the tagline "Everywhere you imagine". Below the navigation bar, there are search fields for keywords and part numbers, along with links for "Parametric Search" and "Document Library". The main content area is titled "E6000H" and includes a breadcrumb trail: "Home / Products / Software and Tools / Emulation and Debugging / In-circuit Emulators (HW)". A sidebar on the left lists various resources: "E6000H", "Specification", "System Configuration", "Documentation", "Downloads", "FAQs", "Options", and "Technical Update". A "Full Product Info" button is located on the right. The main content area features a photograph of the E6000H emulator hardware, which consists of a white vertical unit and a green printed circuit board (PCB) connected by a black cable. Two yellow callout boxes are overlaid on the page: one pointing to the "Documentation" link in the sidebar with the text "Here is a site for emulator related documents.", and another pointing to the "Downloads" link with the text "Here is a site for software version-up program."

MEMO



Renesas Technology Corp.

©2007. Renesas Technology Corp., All rights reserved.