

# HS-19 Series:

## 19" Heatsink Enclosure

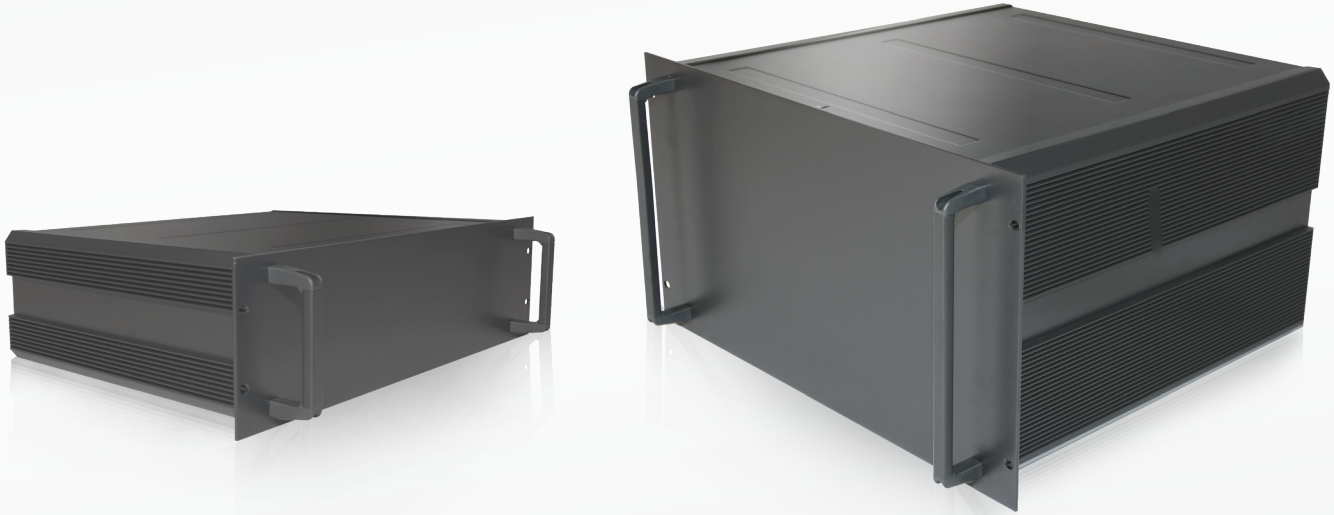

The HS-19 Series of rack mounted 19" heatsink enclosures is a versatile and user friendly 19" enclosure series. Designed for both professional users and home hobbyists alike, HS-19 features extruded aluminum heatsink side panels. The high grade aluminum body features removable top and bottom panels providing easy access to work inside.

An inner front panel allows you to mount all your components on it and the 3.00 mm thick Aluminum outer front panel covers it to give your project a professional look. Extruded aluminum component mounting rails are slotted to allow for convenient PCB and component installation. HS-19 is provided with self adhesive rubber feet if rack mounting is not required.

### Key Features

- Extruded heatsink side panels provide excellent cooling
- Inside face of side panels have slot for easy general purpose bar installation
- All aluminum construction
- Inner front panel for component mounting allows outer front panel to remain "clean" appearance
- "Open Frame" design maximizes user convenience for component assembly
- Heavy duty handles
- Optional mounting plates for PCB and heavy components such as transformers
- 19" rack mounted or free standing
- Flat pack for efficient storage and shipping

## Standards and Materials

- Heights from 1U to 6U
- Depths of 245mm, 335mm and 425mm
- Conforms to IEC-60297-3.
- Premium grade aluminum sheet: AL 5052 and extrusion: AA 6063 (Aluminum Alloy).
- Designed and manufactured under ISO 9001:2015 and ISO 14001:2015
- All materials RoHS compliant. 

■ 15 sizes to select

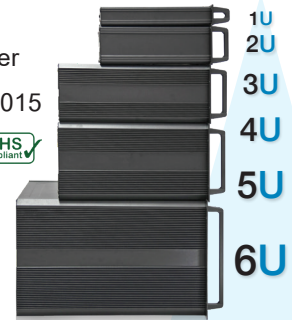

## Applications

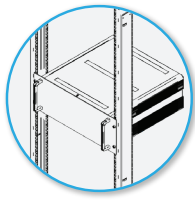

Installing on 19" Rack

Attaching electronic component to heatsink side frame

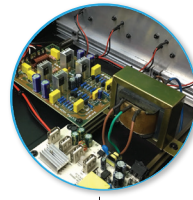

Mounting PSU for component on the GP bar

Mounting PCB on the GP bar and attaching electronic component to heatsink side frame

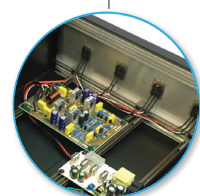

## Models & Dimensions

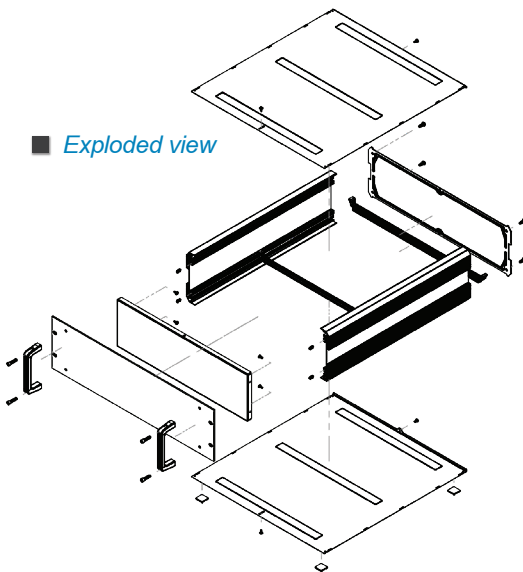

■ Exploded view

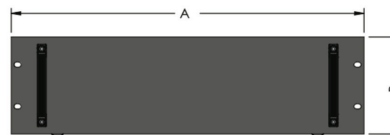

■ Pic. 1: Front view



■ Pic. 2: Side view

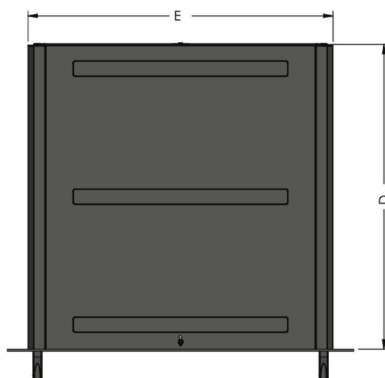

■ Pic. 3: Top view

Size	Front Panel (A x B mm.) Pic. 1	Cabinet Size (E x D x C mm.) Pic. 2&3	Handle (G x F mm.) Pic. 2
1U-D1	482.6 x 43.7	425 x 245 x 39.6	38 x 40
1U-D2	482.6 x 43.7	425 x 335 x 39.6	38 x 40
1U-D3	482.6 x 43.7	425 x 425 x 39.6	38 x 40
2U-D1	482.6 x 88.1	425 x 245 x 84.0	82.4 x 40
2U-D2	482.6 x 88.1	425 x 335 x 84.0	82.4 x 40
2U-D3	482.6 x 88.1	425 x 425 x 84.0	82.4 x 40
3U-D2	482.6 x 132.6	425 x 335 x 128.6	113 x 40
3U-D3	482.6 x 132.6	425 x 425 x 128.6	113 x 40
4U-D2	482.6 x 177.0	425 x 335 x 173.0	151 x 40
4U-D3	482.6 x 177.0	425 x 425 x 173.0	151 x 40
5U-D2	482.6 x 221.5	425 x 335 x 217.3	192 x 40
5U-D3	482.6 x 221.5	425 x 425 x 217.3	192 x 40
6U-D2	482.6 x 266.0	425 x 335 x 262.0	236.5 x 40
6U-D3	482.6 x 266.0	425 x 425 x 262.0	236.5 x 40
6U-D4	482.6 x 266.0	425 x 465 x 262.0	236.5 x 40