

SPECIFICATIONS

CUSTOMER	:	_____
SAMPLE CODE	:	SIA800480T030-ZHC
MASS PRODUCTION CODE	:	HIA800480T030-ZHC
SAMPLE VERSION	:	01
SPECIFICATIONS EDITION	:	002
DRAWING NO. (Ver.)	:	LMD-HIA800480T030-ZHC (Ver.002)
PACKAGING NO. (Ver.)	:	PKG-HIA800480T030-ZHC (Ver.001)

Customer Approved

Date:

Approved	Checked	Designer
林裘中 Daniel Lin	呂清溪 Marcs Lu	黃煜庭 Yuting Huang

- Preliminary specification for design input
- Specification for sample approval

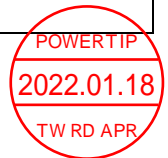

POWERTIP TECH. CORP.

Headquarters: No.8, 6th Road, Taichung Industrial Park,
Taichung, Taiwan
台中市 407 工業區六路 8 號

TEL: 886-4-2355-8168
FAX: 886-4-2355-8166

E-mail: sales@powertip.com.tw
Http://www.powertip.com.tw

Contents

1. SPECIFICATIONS

- 1.1 Features
- 1.2 Mechanical Specifications
- 1.3 Absolute Maximum Ratings
- 1.4 DC Electrical Characteristics
- 1.5 Optical Characteristics

2. MODULE STRUCTURE

- 2.1 Counter Drawing
- 2.2 Connector list
- 2.3 Interface Pin Description

3. QUALITY ASSURANCE SYSTEM

- 3.1 Quality Assurance Flow Chart

4. RELIABILITY TEST

- 4.1 Reliability Test Condition

5. PRECAUTION RELATING PRODUCT HANDLING

- 5.1 Safety
- 5.2 Handling
- 5.3 Storage
- 5.4 Terms of Warranty

Appendix :

- 1. Drawing
- 2. Packaging Specifications
- 3. Assembly Guide

1. SPECIFICATIONS

1.1 Features

Hardware

CPU	RISC Processor	i.MX8M Mini Quad Cortex-A53 @ 1.6 GHz
Memory	On Board RAM	2GB LPDDR4 SDRAM
	On Board ROM	8GB eMMC Flash
	External Storage	1x Micro SD (max. 32G)
Display	Resolution	800 (RGB) x 480 DOTS
	LCD Type	Full Viewing Angle, Normally Black, Transmissive type
	Screen Size	5.0 inch
	Touch Panel	Projected Capacitive Touch (I2C)
I/O	Display Interface	1x MIPI DSI 1x RGB
	USB	1x USB OTG 2x USB1.1/2.0 Compliant Host 1x USB1.1/2.0 in Mini-PCle Connector
	PCI Express	1x Mini-PCle Connector(1-lane)
	Ethernet	10/100/1000 Mbps
	Analog Audio	1 x Headphone Jack 1 x Input
	Wireless	WIFI IEEE 802.11 a/b/g/n/ac Bluetooth 4.2
	Serial	2 x UART (one for Debug Used) 4 x I2C 1 x SPI
Power Input	DC	9V ~ 24V

Software

OS	Embedded	Android / Yocto Linux
-----------	----------	-----------------------

1.2 Mechanical Specifications

Item	Standard Value	Unit
Board Outline Dimension	118.1(W) x 87.0 (L) x 25.0(H) MAX	mm
Display Active Area	108.0 (W) * 64.8 (L)	mm

1.3 Absolute Maximum Ratings

Ta = 25°C

Item	Symbol	Condition	Min.	Max.	Unit
Power Supply	V _{IN}	—	-0.3	26.0	V
Operating Temperature	T _{OP}	—	-20	70	°C
Storage Temperature	T _{ST}	—	-30	80	°C
Humidity	H _D	Ta=60 °C	10	90	%RH

1.4 DC Electrical Characteristics

Ta = 25°C

Item	Symbol	Condition	Min.	Typ.	Max.	Unit
Power Supply Voltage	V _{IN}	-	9	12	24	V
Power Supply Current	I _{IN1}	V _{IN} = 12V	-	280	-	mA
IO High-Level input voltage	V _{IH}	-	0.7xV _{DD3V3}	-	V _{DD3V3} +0.3	V
IO Low-Level input voltage	V _{IL}	-	-0.3	-	0.3xV _{DD3V3}	V
IO High-Level output voltage	V _{OH}	-	-	-	3.6	V
IO Low-Level output voltage	V _{OL}	-	-0.3	-	-	V

Note 1: V_{IN} is connected to 'J4' connector.

1.5 Optical Characteristics

Ta=25°C

Item		Symbol	Condition	Min.	Typ.	Max.	unit	-
Response time	Tr + Tf	25°C	-	-	37	56	ms	Note2
Viewing angle	Top	$\theta Y+$	CR \geq 10	-	80	-	Deg.	Note4
	Bottom	$\theta Y-$		-	80	-		
	Left	θX		-	80	-		
	Right	θX		-	80	-		
Contrast ratio		CR		650	800	-	-	Note3
Color of CIE Coordinate (With B/L & T/P)	White	X	Ta = 25°C $\theta X, \theta Y = 0^\circ C$	-	0.29	-	-	Note1
		Y		-	0.33	-		
	Red	X		-	0.55	-		
		Y		-	0.33	-		
	Green	X		-	0.34	-		
		Y		-	0.60	-		
	Blue	X		-	0.14	-		
		Y		-	0.09	-		
Average Brightness Pattern=white display (With T/P) *1		IV	VCC=12V PWM="Hight" (Duty=100%)	680	850	-	cd/m ²	
Uniformity (With T/P) *2		ΔB		70	-	-	%	

Note 1:

*1 : $\Delta B = B(\min) / B(\max) * 100\%$

*2 : Measurement Condition for Optical Characteristics:

a : Environment: $25^{\circ}\text{C} \pm 5^{\circ}\text{C}$ / $60 \pm 20\%$ R.H , no wind , dark room below 10 Lux at typical lamp current and typical operating frequency.

b : Measurement Distance: 500 ± 50 mm , ($\theta = 0^{\circ}$)

c : Equipment: TOPCON BM-7 fast , (field 1°) , after 10 minutes operation.

d : The uncertainty of the C.I.E coordinate measurement ± 0.01 , Average Brightness $\pm 4\%$

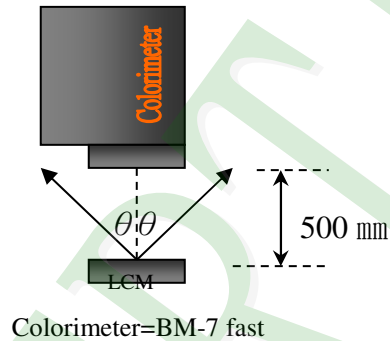
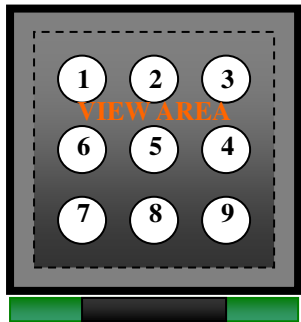

To be measured at the center area of panel with a viewing cone of 1° by Topcon luminance meter BM-7, after 10 minutes operation (module)

Note2: Definition of response time:

The output signals of photo detector are measured when the input signals are changed from "black" to "white" (falling time) and from "white" to "black" (rising time), respectively. The response time is defined as the time interval between the 10% and 90% of Amplitudes.

Refer to figure as below:

Normally White



Normally Black

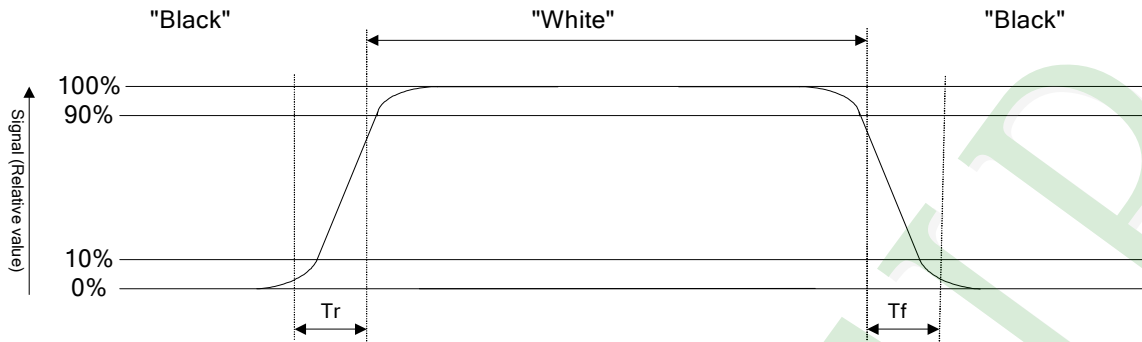

Note3: Definition of contrast ratio:

Contrast ratio is calculated with the following formula

$$\text{Contrast ratio (CR)} = \frac{\text{Photo detector output when LCD is at "White" state}}{\text{Photo detector output when LCD is at "Black" state}}$$

Note4: Definition of viewing angle:

Refer to figure as below:

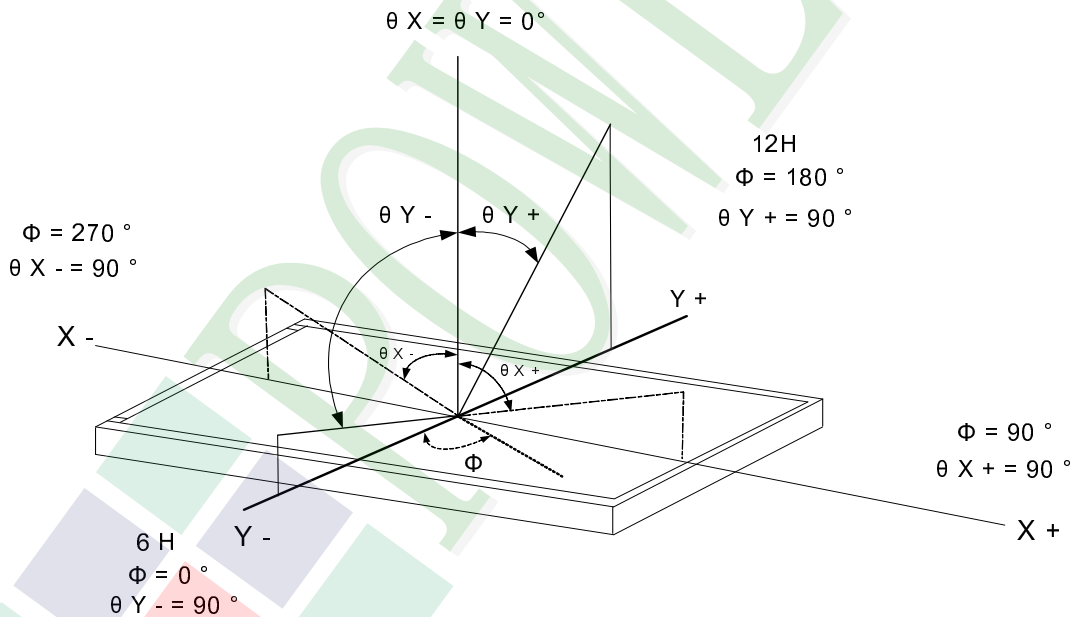

2. MODULE STRUCTURE

2.1 Counter Drawing

2.1.1 LCM Mechanical Diagram

* See Appendix

2.1.2 Block Diagram

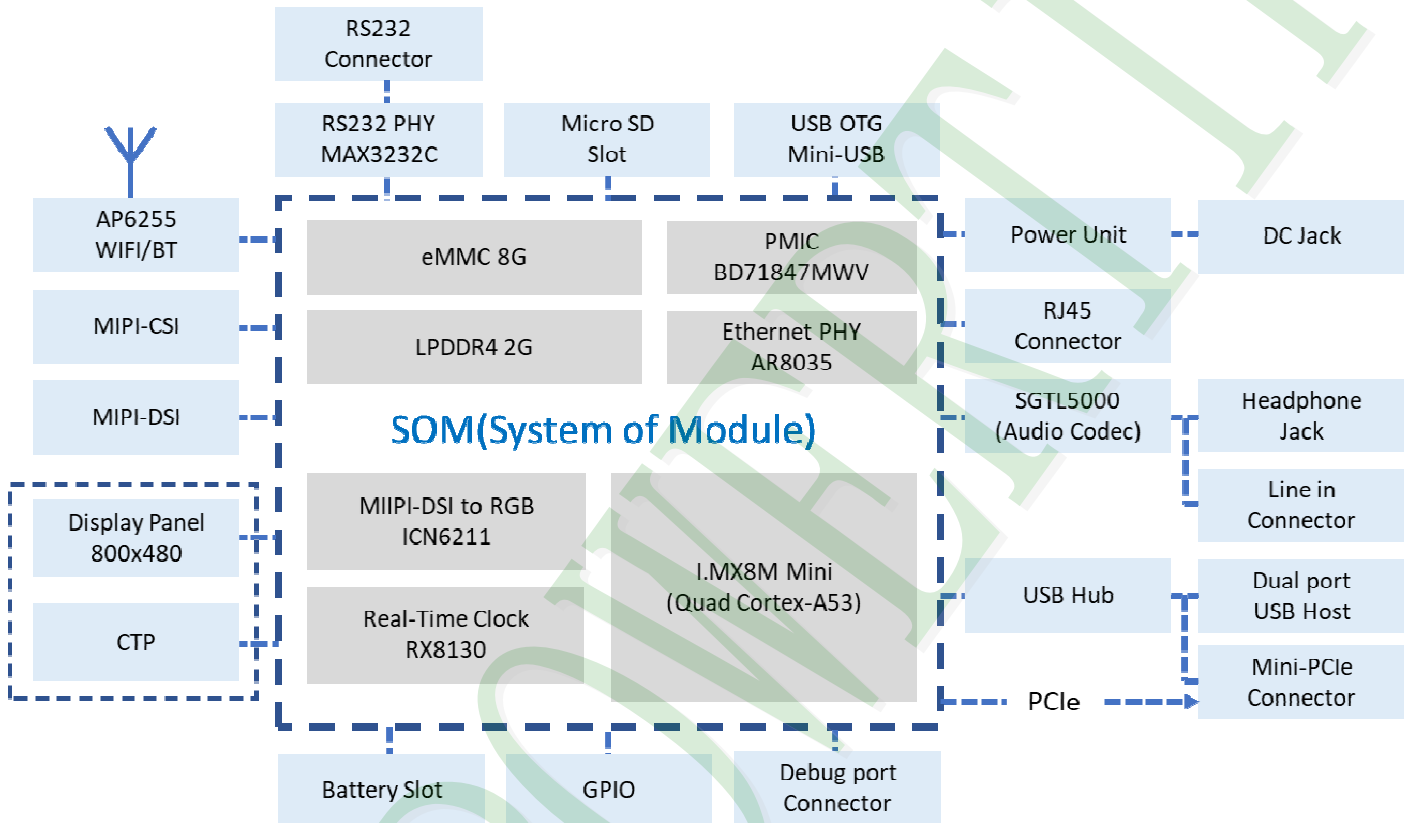

2.2 Connector list

Symbol	Description	Note
J2	Extension Power Pin	
J3	RTC Power Supply (Pitch 1.25mm)	
J4	Power Supply (DC Jack)	
J5	Audio Signal Input (Pitch 1.25mm)	
J6	Antenna Connector	
J8	-	No Function
J9	Display – MIPI DSI (Pitch 0.5mm 30pin)	
J11	CTP Interface (Pitch 1.25mm 6pin)	
J12	CTP Interface (Pitch 0.5mm 6pin)	(CTP)
J13	Display – Parallel RGB (Pitch 0.5mm 50pin)	(Display Panel)
J14	-	No Function
J15	Display – Parallel RGB (Pitch 2.0mm, 2x20pin)	
J16	Backlight Power (Pitch 2.0mm 6 pin)	
J17	USB 1.1/2.0 Host (Pitch 1.25mm, 5pin)	
J18	Micro SD Card	
J19	USB 2.0 Device USB Port Mini-B (USB OTG)	
J20	USB 1.1/2.0 Host USB Port Type A	
J22	Mini-PCle Connector	
J23	Power Output (Pitch 1.25mm)	
J25	UART2 Debug (Pitch 1.25mm 4pin)	
J26	RS232 (Pitch 2.0mm 2x5pin)	
J28	-	No Function
J29	GPIO (Pitch 2.0mm 2x10pin)	
J30	Camera – MIPI CSI (Pitch 0.5mm 30pin)	
J31	-	No Function
J34	Ethernet RJ45	
CN2	Standard Headphone Jack φ 3.5mm.	
SW1	Reset Button	
SW2	ON/OFF Power Button	
JP1	Boot Switch	
BAT1	Battery	

2.3 Interface Pin Description

J2 --- Extension Power Pin (Pitch 1.25mm)

Pin No.	Symbol	Type	DESCRIPTION
1	PWEN		Power Indicator LED (LED1)
2	NC	-	-
3	BTN RSTINn	P	As Reset Button, SW1 (Active Low)
4	NC	-	-
5	ONOFF	P	As ONOFF Power Button, SW2 (Active Low)
6	GND	P	Ground

J3 --- RTC Power Supply (Pitch 1.25mm)

Pin No.	Symbol	Type	DESCRIPTION
1	GND	P	Ground
2	V _{BAT}	P	RTC Power Supply

J4 --- System Power Supply

Pin No.	Symbol	Type	DESCRIPTION
+	V _{IN}	P	DC Power Supply of System
-	GND	P	Ground

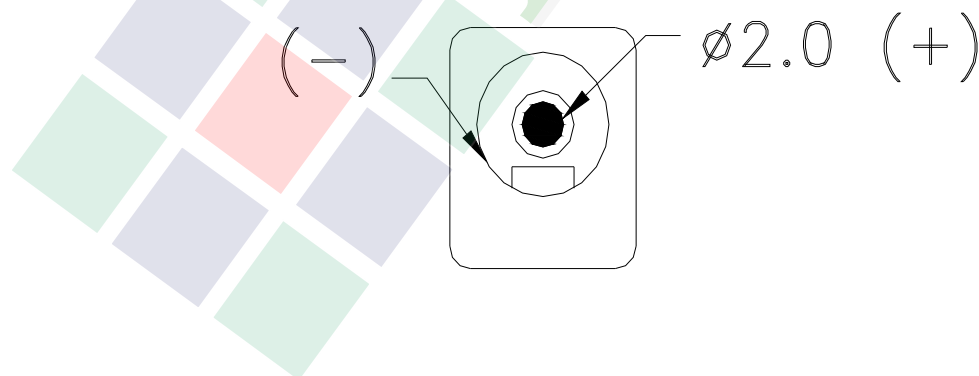

J5 --- Audio Signal Input (Pitch 1.25mm)

Pin No.	Symbol	Type	DESCRIPTION
1	LINEINL	A	Line-in Left Channel Input
2	LINEINR	A	Line-in Right Channel Input
3	GND	P	Ground
4	GND	P	Ground

Display Interface --- MIPI DSI (J9 – Pitch 0.5mm 30pin)

Function	Symbol	Type	DESCRIPTION	J9
Power	V _{LCD3V3}	P	+3.3V Power Supply for Display Module	3, 4
	V _{DD3V3}	P	+3.3V Output	7
	V _{DD5V}	P	+5.0V Output	1,2
	GND	P	Ground	6, 8, 13, 15, 18, 21, 24, 27, 30
MIPI DSI Signal	MIPI_CLK_N	DS	MIPI DSI Clock Negative	26
	MIPI_CLK_P		MIPI DSI Clock Positive	25
	MIPI_D0_N		MIPI DSI Data 0 Negative	29
	MIPI_D0_P		MIPI DSI Data 0 Positive	28
	MIPI_D1_N		MIPI DSI Data 1 Negative	23
	MIPI_D1_P		MIPI DSI Data 1 Positive	22
	MIPI_D2_N		MIPI DSI Data 2 Negative	20
	MIPI_D2_P		MIPI DSI Data 2 Positive	19
	MIPI_D3_N		MIPI DSI Data 3 Negative	17
	MIPI_D3_P		MIPI DSI Data 3 Positive	16
Other	I2C4_SDA	IO	I2C Port4 Serial Data	9
	I2C4_SCL	IO	I2C Port4 Serial Clock	10
	CTP_RST	O	CTP Reset Signal	11
	CTP_INT	I	CTP Interrupt Signal	12
	GPIO3_IO23	IO	General-Purpose I/O	14

J11, J12 --- CTP Interface
(J11 – Pitch 1.25mm 6pin, J12 – Pitch 0.5mm 6pin)

Pin No.	Symbol	Type	DESCRIPTION
1	GND	P	Ground
2	V _{DD3V3}	P	+3.3V
3	I2C4_SCL	IO	I2C Port3 Serial Clock
4	I2C4_SDA	IO	I2C Port3 Serial Data
5	CTP_INT	I	CTP Interrupt Signal
6	CTP_RST	O	CTP Reset Signal

J13, J15 --- Display Interface --- Parallel RGB
(J13 – Pitch 0.5mm 50pin, J15 – Pitch 2.0mm, 2x20pin)

Function	Symbol	Type	DESCRIPTION	J13	J15
Power	V _{LCD3V3}	P	+3.3V power supply for Display module	2,3	1,2,3
	V _{DD5V}	P	+5.0V Output	4,5	39
	GND	P	Ground.	1,7,12,17,22,27,32,37,40,42,44,50	4,5,6,13,14,19,20,40
Display Data	DISP0_DAT0	O	Display Data B0	28	8
	DISP0_DAT1		Display Data B1	29	7
	DISP0_DAT2		Display Data B2	30	10
	DISP0_DAT3		Display Data B3	31	9
	DISP0_DAT4		Display Data B4	33	12
	DISP0_DAT5		Display Data B5	34	11
	DISP0_DAT6		Display Data B6	35	18
	DISP0_DAT7		Display Data B7	36	17
	DISP0_DAT8		Display Data G0	18	22
	DISP0_DAT9		Display Data G1	19	21
	DISP0_DAT10		Display Data G2	20	16
	DISP0_DAT11		Display Data G3	21	15
	DISP0_DAT12		Display Data G4	23	24
DISP0_DAT13	Display Data G5	24	23		

	DISP0_DAT14		Display Data G6	25	26
	DISP0_DAT15		Display Data G7	26	25
	DISP0_DAT16		Display Data R0	8	28
	DISP0_DAT17		Display Data R1	9	27
	DISP0_DAT18		Display Data R2	10	30
	DISP0_DAT19		Display Data R3	11	29
	DISP0_DAT20		Display Data R4	13	32
	DISP0_DAT21		Display Data R5	14	31
	DISP0_DAT22		Display Data R6	15	34
	DISP0_DAT23		Display Data R7	16	33
	DISP0_CLK		Display Pixel Clock Signal	43	37
	DISP0_VSYNC		Display VSYNC Signal	39	36
	DISP0_HSYNC		Display HSYNC Signal	38	35
	DISP0_DE		Display Data Enable Signal	41	38
Others	NC	-	Not Connection	45,46,47	-
	DISP_CTL	O	Display On/Off Signal, '1' = On, '0' = Off	48	-
	DISP_RST	O	Display reset signal by RC circuit, connect a 10K ohm resistor to V _{DD3V3} and a 100nF capacitor to GND	49	-
	DISP_PWM	O	Backlight PWM Control Signal	6	-

J16 --- Backlight Power (Pitch 2.0mm 6pin)

Pin No.	Symbol	Type	DESCRIPTION
1	VBLOUT	P	VBLOUT is connected to V _{IN} directly
2	VBLOUT	P	VBLOUT is connected to V _{IN} directly
3	GPIO0_IO00	O	General-Purpose I/O
4	PWM1	IO	PWM signal output for backlight
5	GND	P	Ground
6	GND	P	Ground

J17 --- USB 1.1/2.0 Host (Pitch 1.25mm, 5pin)

Pin No.	Symbol	Type	DESCRIPTION
1	V _{USB5V}	P	+5.0V USB Power Supply
2	D-	DS	Data – (Data M)
3	D+	DS	Data + (Data P)
4	GND	P	Ground
5	GND	P	Ground

J19 --- USB 2.0 Device USB Port Mini-B (USB OTG)

Pin No.	Symbol	Type	DESCRIPTION
1	V _{USB5V}	P	+5.0V USB Power Supply
2	D-	DS	Data – (Data M)
3	D+	DS	Data + (Data P)
4	ID	-	USB ID
5	GND	P	Ground

J20 --- USB 1.1/2.0 Host USB Port Type A * 2

Pin No.	Symbol	Type	DESCRIPTION
1	V _{DD5V}	P	+5.0V Output
2	D-	DS	Data – (Data M)
3	D+	DS	Data + (Data P)
4	GND	P	Ground

J22 --- Mini-PCle Connector

Function	Symbol	Type	DESCRIPTION	J30
Power	V _{DD3V3}	P	+3.3V Output	2, 24, 39, 41, 52
	V _{DD1V5}	P	+1.5V Output	6, 28, 48
	GND	P	Ground	4, 9, 15, 18, 21, 26, 27, 29, 34, 35, 37, 40, 43, 50
PCIe	PCIE_RX_N	DS	PCIE Receiver Signal -	23
	PCIE_RX_P		PCIE Receiver Signal +	25
	PCIE_TX_N		PCIE Transmitter Signal -	31
	PCIE_TX_P		PCIE Transmitter Signal +	33
	PCIE_CLK_N		PCIE Clock Signal -	11
	PCIE_CLK_P		PCIE Clock Signal +	13
	PCIE_WAKE	IO	Wake Up Signal	1
	PCIE_RESET		Reset Signal	22
	PCIE_DISABLE		Disable Signal	20
USB	USB_D_N	DS	Data - (Data M)	36
	USB_D_P		Data + (Data P)	38
I2C	I2C2_SCL	IO	I2C Port2 Serial Clock	30
	I2C2_SDA		I2C Port2 Serial Data	32
Other	LED_WWAN	-	LED P1	42
	LED_WLAN	-	LED P2	44
	LED_WPAN	-	LED P3	46
	NC	-	Not Connection	3, 5, 7, 8, 10, 12, 14, 16, 17, 19, 45, 47, 49, 51

J23 --- Power Output (Pitch 1.25mm)

Pin No.	Symbol	Type	DESCRIPTION
1	V _{DD5V}	P	+5.0V Output
2	V _{DD5V}	P	+5.0V Output
3	GND	P	Ground
4	GND	P	Ground

J25 --- UART Debug (Pitch 1.25mm, 4pin)

Pin No.	Symbol	Type	DESCRIPTION
1	V _{DD3V3}	P	+3.3V Output
2	UART2_TXD	IO	UART2 Transmitter Signal (3.3V Level)
3	UART2_RXD	IO	UART2 Receiver Signal (3.3V Level)
4	GND	P	Ground

J26 --- RS232 (Pitch 2.0mm, 2x5pin)

Pin No.	Symbol	Type	DESCRIPTION
1	NC	-	Not Connection
2	RS232_RXD	I	RS232 Receiver Signal (UART3, RS232 level)
3	RS232_TXD	O	RS232 Transmitter Signal (UART3, RS232 level)
4	V _{DD3V3}	P	+3.3V Output
5	GND	P	Ground
6	NC	-	Not Connection
7	NC	-	Not Connection
8	NC	-	Not Connection
9	NC	-	Not Connection
10	GND	P	Ground

J29 --- GPIO (Pitch 2.0mm, 2x10pin)

Pin No.	Symbol	Type	DESCRIPTION
1	V _{DD3V3}	P	+3.3V Output
2	V _{DD5V}	P	+5.0V Output
3	GND	P	Ground
4	GND	P	Ground
5	UART4_TXD	IO	M4 Debug - UART4 Transmitter Signal (3.3V Level)
6	GPIO3_IO22	IO	General-Purpose I/O
7	UART4_RXD	IO	M4 Debug - UART4 Receiver Signal (3.3V Level)
8	I2C3_SCL	IO	I2C3 serial clock
9	GPIO3_IO01	IO	General-Purpose I/O
10	I2C3_SDA	IO	I2C3 serial Data
11	GPIO3_IO00	IO	General-Purpose I/O
12	ECSPI2_SS0	IO	CSPI2 Chip Select Signal 0
13	GPIO3_IO25	IO	General-Purpose I/O
14	ECSPI2_SCLK	IO	CSPI2 Serial Clock Signal
15	GPIO3_IO08	IO	General-Purpose I/O
16	ECSPI2_MISO	IO	CSPI2 MISO Serial Data Signal
17	GPIO3_IO09	IO	General-Purpose I/O
18	ECSPI2_MOSI	IO	CSPI2 MOSI Serial Data Signal
19	GND	P	Ground
20	GND	P	Ground

Camera Interface --- MIPI CSI (J30 – Pitch 0.5mm 30pin connector bottom contact)

Function	Symbol	Type	DESCRIPTION	J30
Power	V _{DD5V}	P	+5.0V Output	1
	V _{DD1V8}	P	I/O voltage for Camera module	4
	GND	P	Ground	6, 8, 13, 15, 18, 21, 24, 27, 30
MIPI CSI Signal	MIPI_C_CLK_N	DS	MIPI CSI Clock Negative	26
	MIPI_C_CLK_P		MIPI CSI Clock Positive	25
	MIPI_C_D0_N		MIPI CSI Data 0 Negative	29
	MIPI_C_D0_P		MIPI CSI Data 0 Positive	28
	MIPI_C_D1_N		MIPI CSI Data 1 Negative	23
	MIPI_C_D1_P		MIPI CSI Data 1 Positive	22
	MIPI_C_D2_N		MIPI CSI Data 2 Negative	20
	MIPI_C_D2_P		MIPI CSI Data 2 Positive	19
	MIPI_C_D3_N		MIPI CSI Data 3 Negative	17
	MIPI_C_D3_P		MIPI CSI Data 3 Positive	16
Other	CAM_SDA	IO	I2C2 Serial Data (1.8V Level)	9
	CAM_SCL	IO	I2C2 Serial Clock (1.8V Level)	10
	CSI_RESET	O	Reset Signal for Camera module (1.8V Level)	11
	CSI_CLKO	O	Clock output to Camera module (1.8V Level)	14
	NC	-	Not Connection	2, 3, 5, 7, 12

JP1 --- Boot Switch

JP1[1:2]		BOOT_MODE [1:0]	Boot Type
ON	ON	00	Boot from Fuses
ON	OFF	01	Serial Downloader (USB OTG Port)
OFF	ON	10	Internal Boot (eMMC)
OFF	OFF	11	Reserved

3. QUALITY ASSURANCE SYSTEM

3.1 Quality Assurance Flow Chart

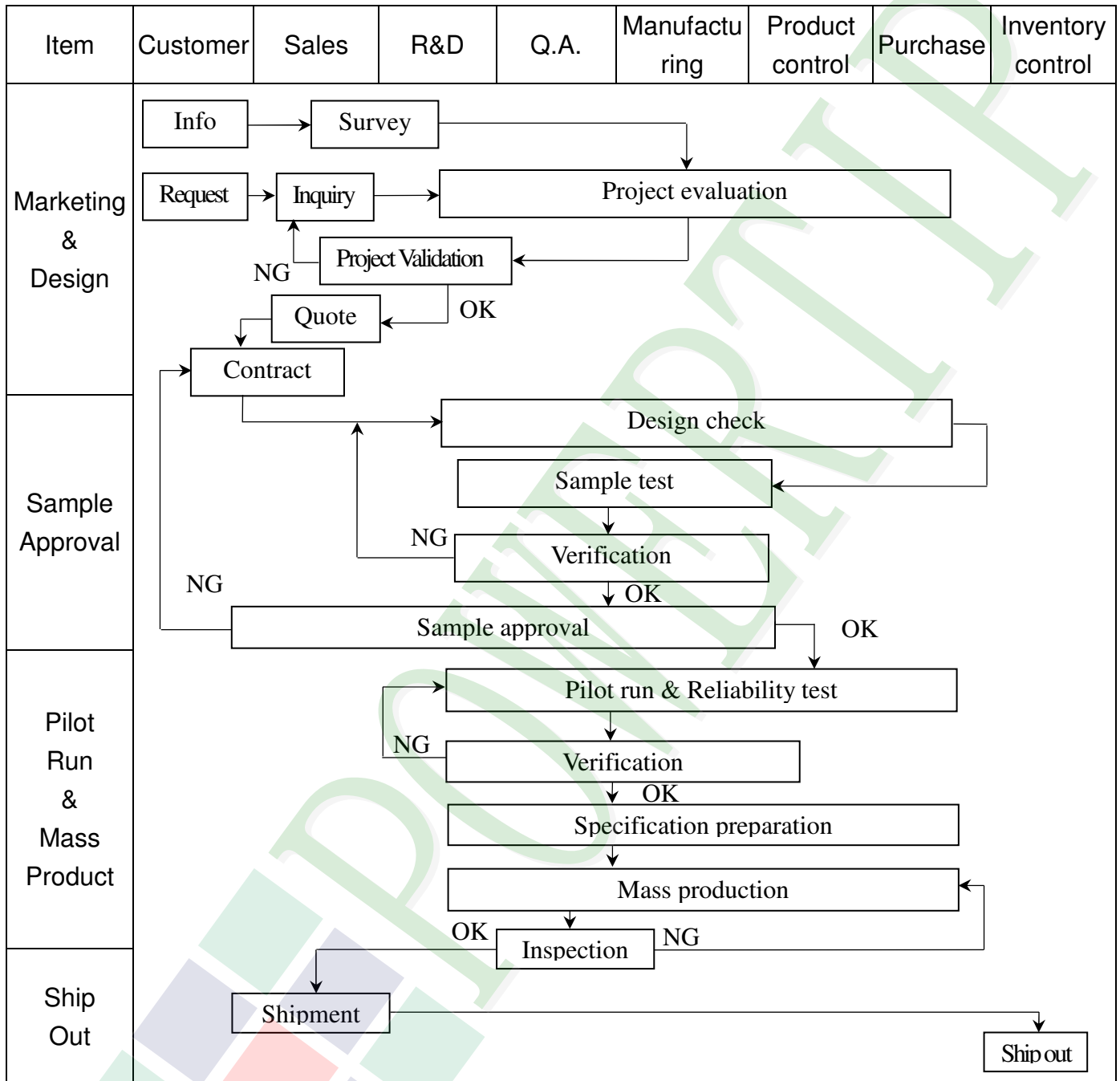

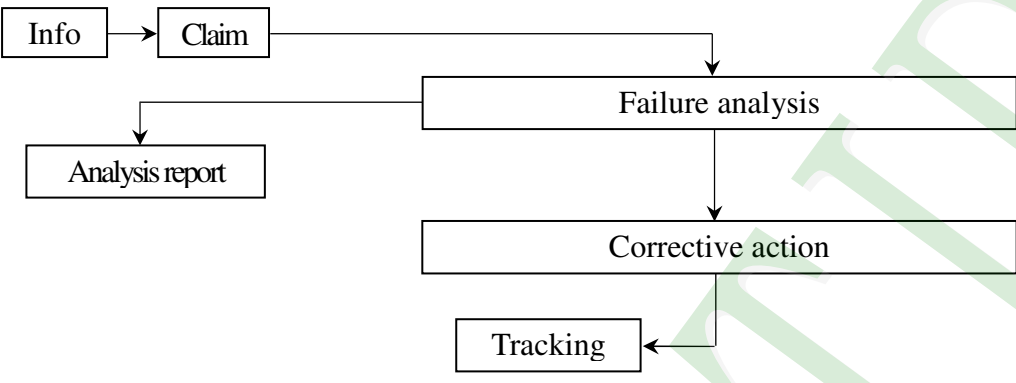
Item	Customer	Sales	R&D	Q.A.	Manufacturing	Product control	Purchase	Inventory control
Sales Service	 <pre> graph TD Info[Info] --> Claim[Claim] Claim --> Failure[Failure analysis] Failure --> Report[Analysis report] Failure --> Action[Corrective action] Action --> Tracking[Tracking] </pre>							
Q.A Activity	1. ISO 9001 Maintenance Activities 3. Equipment calibration 5. Standardization Management				2. Process improvement proposal 4. Education and Training Activities			

5. PRECAUTION RELATING PRODUCT HANDLING

5.1 SAFETY

- 5.1.1 If the LCD panel breaks, be careful not to get the liquid crystal to touch your skin.
- 5.1.2 If the liquid crystal touches your skin or clothes, please wash it off immediately by using soap and water.

5.2 HANDLING

- 5.2.1 Avoid any strong mechanical shock which can break the glass.
- 5.2.2 Avoid static electricity which can damage the CMOS LSI—When working with the module, be sure to ground your body and any electrical equipment you may be using.
- 5.2.3 Do not remove the panel or frame from the module.
- 5.2.4 The polarizing plate of the display is very fragile. So, please handle it very carefully, do not touch, push or rub the exposed polarizing with anything harder than an HB pencil lead (glass, tweezers, etc.)
- 5.2.5 Do not wipe the polarizing plate with a dry cloth, as it may easily scratch the surface of plate.
- 5.2.6 Do not touch the display area with bare hands, this will stain the display area.
- 5.2.7 Do not use ketonic solvent & aromatic solvent. Use with a soft cloth soaked with a cleaning naphtha solvent.
- 5.2.8 To control temperature and time of soldering is $320 \pm 10^{\circ}\text{C}$ and 3 ~ 5 sec.
- 5.2.9 To avoid liquid (include organic solvent) stained on LCM.
- 5.2.10 Caution! (LCM products with Capacitive Touch Panel)
Strong EMI-sources such as switch-mode power supplies (SPS) can lead to touch malfunction (e.g., ghost-touches). Therefore, the touch needs to be thoroughly tested inside the target application.
- 5.2.11 CAUTION: Continuously displaying same static image will result in high possibility of image sticking/image burn-in effect due to TFT panel characteristic.
- 5.2.12 Double-sided tape designed to be attached with the customer's mechanical device, please follow up the rules and regulations published by the original manufacturer of double-side tape for the attachment operation.

5.3 STORAGE

- 5.3.1 Store the panel or module in a dark place where the temperature is $25^{\circ}\text{C} \pm 5^{\circ}\text{C}$ and the humidity is below 65% RH.
- 5.3.2 Do not place the module near organics solvents or corrosive gases.
- 5.3.3 Do not crush, shake, or jolt the module.

5.4 TERMS OF WARRANTY

- 5.4.1 Applicable warrant period
The period is within thirteen months since the date of shipping out under normal using and storage conditions.
- 5.4.2 Unaccepted responsibility
This product has been manufactured to your company's specification as a part for use in your company's general electronic products. It is guaranteed to perform according to delivery specifications. For any other use apart from general electronic equipment, we cannot take responsibility if the product is used in nuclear power control equipment, aerospace equipment, fire and security systems or any other applications in which there is a direct risk to human life and where extremely high levels of reliability are required.

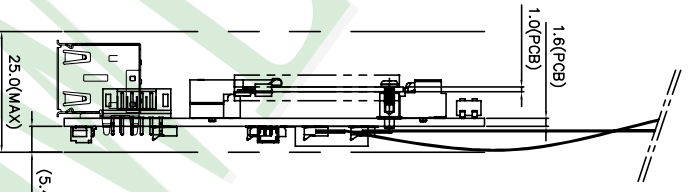
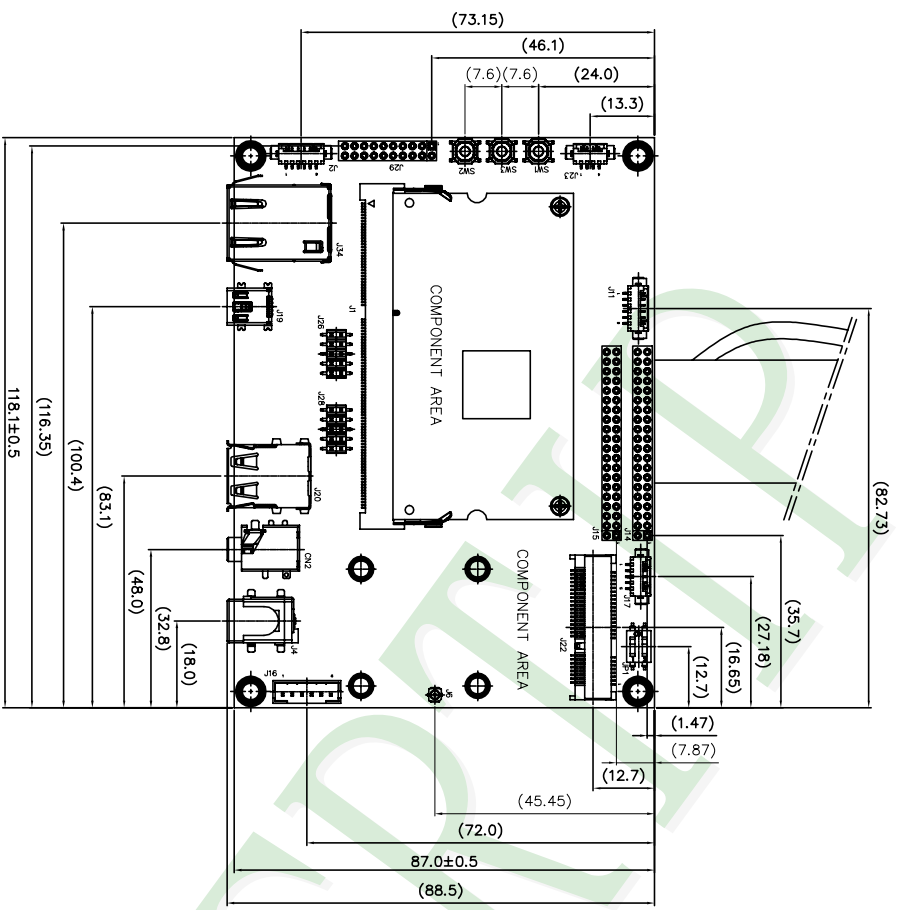

Detail SBC Board
Scale 1X

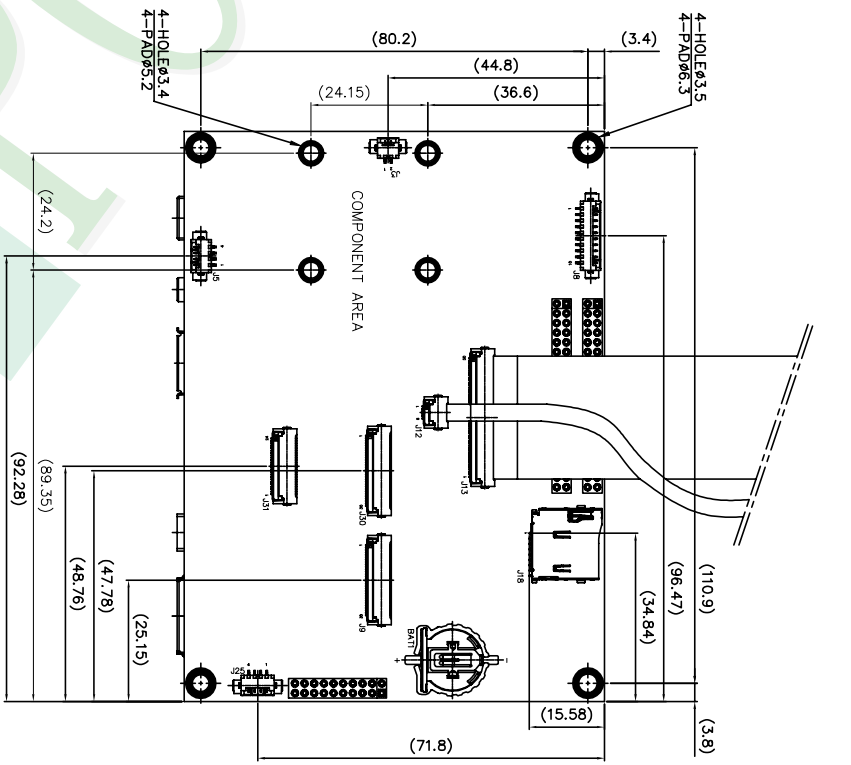



NOTES:

- 5.J2, J11: Molex 532610671 or Compatible
- 6.J3: Molex 532610271 or Compatible
- 7.J5, J23, J25: Molex 532610471 or Compatible
- 8.J8: Molex 532611071 or Compatible

- 9.J9, J30: OMRON XF2M-3015-1A or Compatible
- 10.J16: Molex 894000610 or Compatible
- 11.J17: Molex 532610571 or Compatible
- 12.J31: OMRON XF2M-2415-1A or Compatible

1
2
3
4
5
6

007		PART NO:	HIA800480T030-ZHC	 久正光電股份有限公司 POWER TIP TECHNOLOGY CORPORATION	Design Nini Chen Check Marcos Lu Approve Daniel Lin	 (3) Surface Material Unit MM Scale FIT Page 212	Thickness 63 ~ 250 Quantity 250 ~ 1000	Level - - - -
006		DRAWING NAME:	LMD-HIA800480T030-ZHC					
005								
004								
003								
002	REMOVE J7 - J10 - J27	Nini	2021/12/14					
001	NEW DRAWING	Nini	2021/04/12					
REV	REV BY	REVISER	DATE					

LCM包裝規格書

LCM Packaging Specifications

Approve	Check	Contact
Marcus	Bright	Nini

1. 包裝材料規格表 (Packaging Material) : (per carton)

No.	Item	Model	Dimensions (mm)	1Pcs Weight	Quantity	Total Weight
1	模組 (LCM)	PH800480T030-ZHC	131 X 90.5 X 4.99	0.0867	12	1.0404
2	紙內襯 (1)Lined with paper	BX00000000132	347 X 262	0.07	12	0.84
3	抗靜電袋(2)Antistatic Bag	BAG240170ARABA	170 X 240	0.005	12	0.06
4	線材 50Pin L=100mm(FFC A)	CB00000000165	25.5 X 100	0.009	12	0.108
5	線材 6Pin L=150mm(FFC B)	CB00000000160	3.5 X 150	0.001	12	0.012
6	抗靜電袋(3)Antistatic Bag	BAG0000000004	80 X 300	0.0005	12	0.006
7	延伸板(Extension Board)	—————	38 X 29.5X3.2	0.0042	12	0.05
8	銅柱(Stand)	OTSPACER00024	φ 4.5X 6.7	0.0007	24	0.0168
9	抗靜電袋(4)Antistatic Bag	BAG0000000052	85 X 50	0.0005	24	0.012
10	系統板(SBC Board)	—————	87 X 118.1X21.5	0.0808	12	0.9696
11	抗靜電袋(5)Antistatic Bag	BAG150120ARABA	150 X 120	0.0021	12	0.0252
12	紙內襯 (6)Lined with paper	BX00000000133	342 X 257	0.043	12	0.516
13	內盒(7)Product Box	BX00000000131	258 X 175 X 58	0.11	12	1.32
14	內盒(8)Product Box	BX36627063ABBA	383 X 270 X 66	0.2	6	1.2
15	保利龍板(9)Polylon board	OTPLB00PL08ABA	550 X 393 X 20	0.0284	2	0.0568
16	外紙箱(10)Carton	BX57041027CCBA	570 X 410 X 265	1.4208	1	1.4208

2. 一 整箱總重量 (Total LCD Weight in carton) : 7.67 Kg±10%

3. 單箱數量規格表 (Packaging Specifications and Quantity) :

(1)LCM quantity per small box : no per lined with paper	1	x no of small box	1	=	1
(2)Total LCM quantity in big box : quantity per small box	1	x no of big boxes	2	=	2
(3)Total LCM quantity in carton : quantity per big box	2	x no of cartons	6	=	12

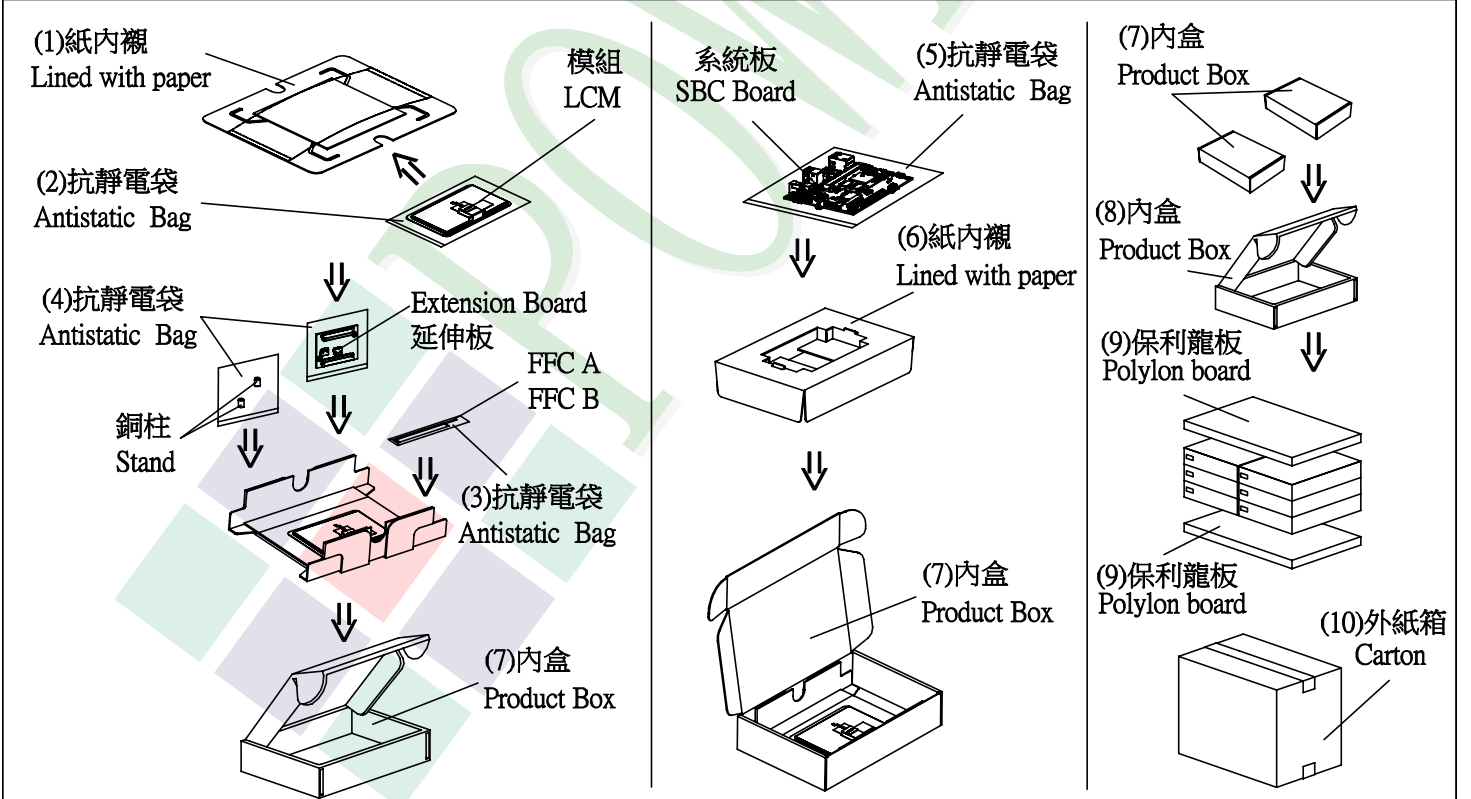

特 記 事 項 (REMARK)

--	--	--

HIA800480T030-ZHC Assembly Guide(TOP)

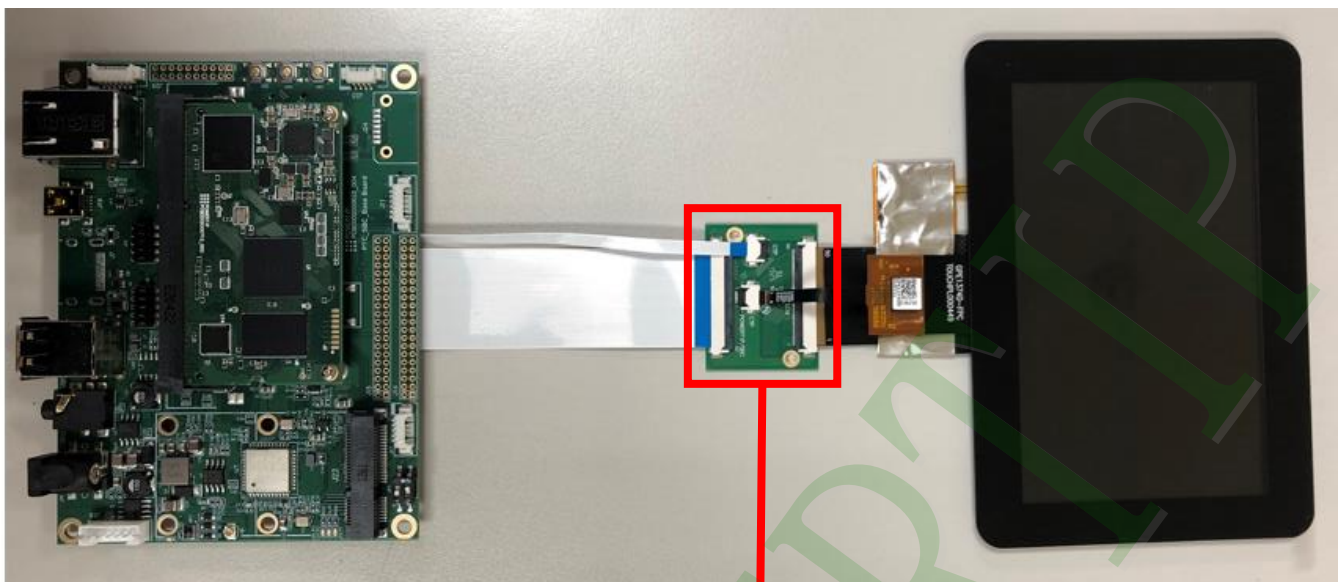

HIA800480T030-ZHC Assembly Guide(BOTTOM)

