



Features

- Toroid core for high coupling and low radiation
- Complies with IEC 60950-1, IEC 62368-1 and IEC 60664-1
- cULus UL 62368-1 recognized, File No. [E515965](#) (six models)
- Reinforced insulation for working voltage of 800 Vrms, 1000 Vpeak

- Designed for isolation power supplies using TI SN6501 and SN6505B
- AEC-Q200 compliant
- RoHS compliant*

HCT Series - High Clearance and Creepage Distance Transformers

Electrical Specifications @ 25 °C

Bourns Part Number**	Primary Inductance @ 100 kHz	Leakage Inductance @ 100 kHz / 0.1 V (All Sec. Pins Shorted)	Turns Ratio P(1-3) : S(6-4)	Pri. (1-3) DCR (Ω) Max.	Sec. (6-4) DCR (Ω) Max.	UL Recognition
	L 1-3 (μH) Min.	Lk 1-3 (μH) Max.				
HCTSM80101AAL	250	0.8	1 : 1	0.30	0.20	✓
HCTSM80102AAL	250	0.6	1 : 2	0.30	0.35	✓
HCTSM80201AAL	250	1.2	2 : 1	0.30	0.15	✓
HCTSM80304BAL	300	0.6	3 : 4	0.30	0.30	
HCTSM80305BAL	300	0.6	3 : 5	0.30	0.30	
HCTSM80308BAL	300	0.7	3 : 8	0.50	0.85	
HCTSM80403AAL	250	0.8	4 : 3	0.30	0.20	✓
HCTSM80803AAL	250	1.8	8 : 3	0.30	0.15	✓
HCTSM80809AAL	250	0.6	8 : 9	0.30	0.25	✓
HCTSM80910BAL	300	0.9	9 : 10	0.30	0.25	
HCTSM81017CAL	350	0.9	10 : 17	0.42	0.48	

**Add E or E1 part number suffix - See How to Order.

Product Dimensions

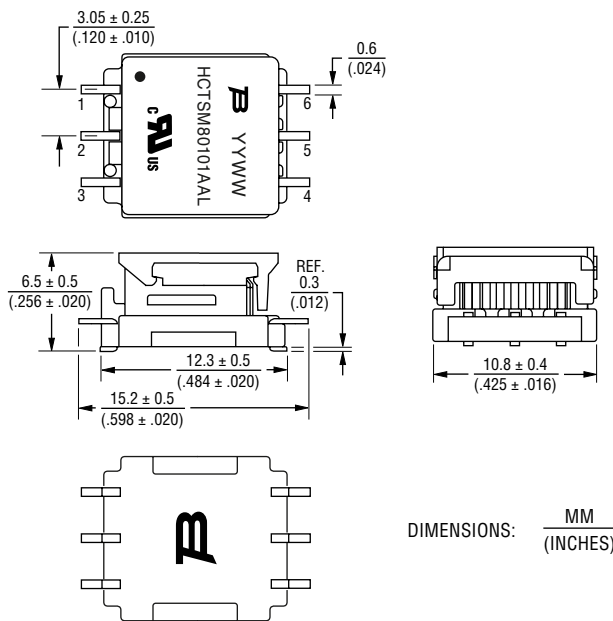

DIMENSIONS: $\frac{\text{MM}}{\text{(INCHES)}}$



WARNING Cancer and Reproductive Harm - www.P65Warnings.ca.gov

*RoHS Directive 2015/863, Mar 31, 2015 and Annex.

Specifications are subject to change without notice.

Users should verify actual device performance in their specific applications.

The products described herein and this document are subject to specific legal disclaimers as set forth on the last page of this document, and at www.bourns.com/docs/legal/disclaimer.pdf.

Additional Information

Click these links for more information:



General Specifications

Primary (1-3) E*T Constant..11 V-μS min.
 Rated Current.....350 mA AC
 Hi-Pot: Primary/Secondary
5K Vdc, 60 seconds
 Operating Temperature
-40 °C to +125 °C
 (Temperature rise included)
 Storage Temperature (Component)
-40 °C to +125 °C
 Clearance/Creepage Distance
 of Primary to Secondary 8 mm min.
 Level of Insulation..... Reinforced for a
 working voltage of 800 Vrms,
 1000 Vpeak, Material Group 1,
 Overvoltage Category II, Pollution
 degree 2, Altitude 2000 m
 Moisture Sensivity Level 1
 ESD Classification (HBM)..... N/A

Materials

Core.....Ferrite
 Wire ... Enameled/triple-insulated copper
 Terminal FinishSn
 Packaging..... 500 pcs. per 13-inch reel

Electrical Schematic

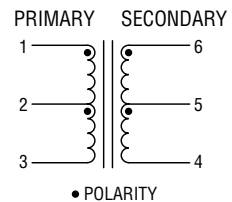

Recommended Layout

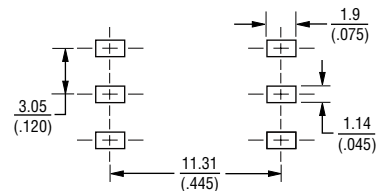

Reflow Solder Profile

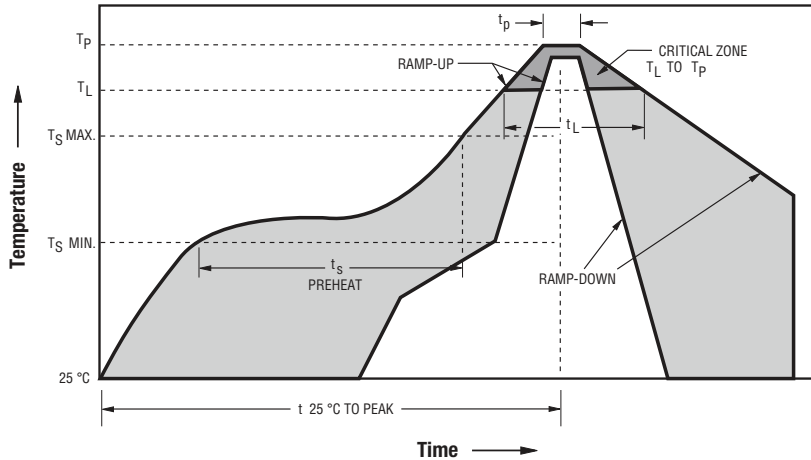

Profile Feature	Pb-Free Assembly
Average Ramp-Up Rate ($T_{S_{max}}$ to T_p)	3 °C / second max.
PREHEAT: Temperature Min. ($T_{S_{min}}$) Temperature Max. ($T_{S_{max}}$) Time ($T_{S_{min}}$ to $T_{S_{max}}$) (t_s)	150 °C 200 °C 60~180 seconds
TIME MAINTAINED ABOVE: Temperature (T_l) Time (t_l)	217 °C 60~150 seconds
Peak Temperature (T_p)	245-250 °C
Time within 5 °C of Actual Peak Temperature (t_p)	20~40 seconds
Ramp-Down Rate	6 °C / second max.
Time 25 °C to Peak Temperature	8 minutes max.

Typical Application

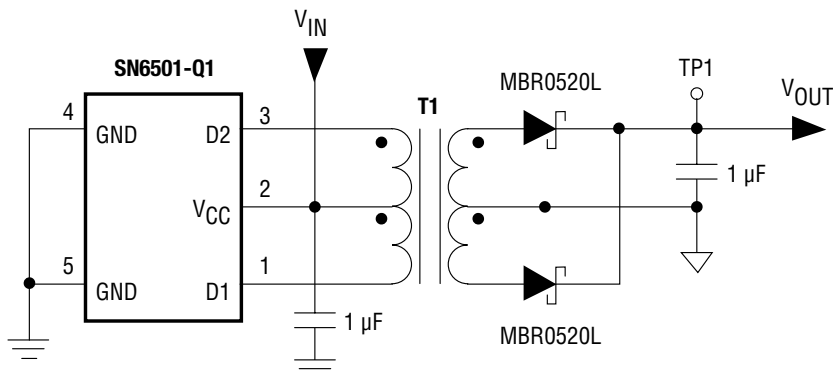

How to Order

HCTSM80101A A L - *

Model _____
 AEC-Q200 Compliancy Designator _____
 RoHS Compliancy Designator _____
 Tape & Reel Packaging
 E = 500 pcs. per 13-inch Reel,
 5 Reels per Box,
 MOQ/Mult: 2500 pcs./2500 pcs.
 E1 = 500 pcs. per 13-inch Reel,
 1 Reel per Box,
 MOQ/Mult: 500 pcs./500 pcs.

Specifications are subject to change without notice.

Users should verify actual device performance in their specific applications.

The products described herein and this document are subject to specific legal disclaimers as set forth on the last page of this document, and at www.bourns.com/docs/legal/disclaimer.pdf.

Efficiency vs. Load Curves*

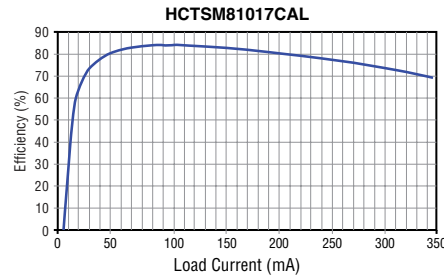
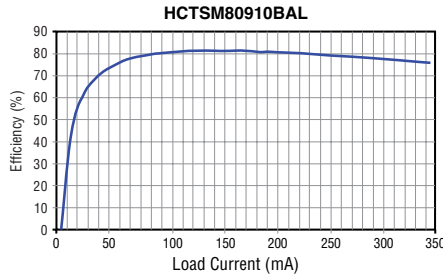
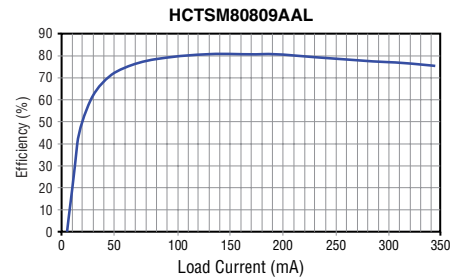
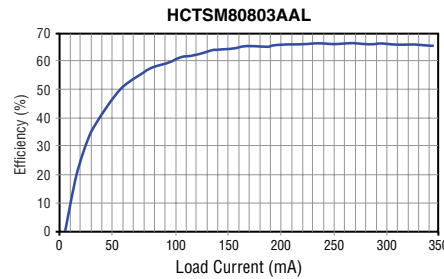
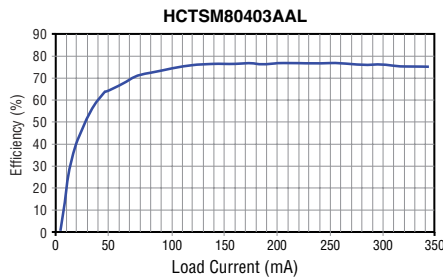
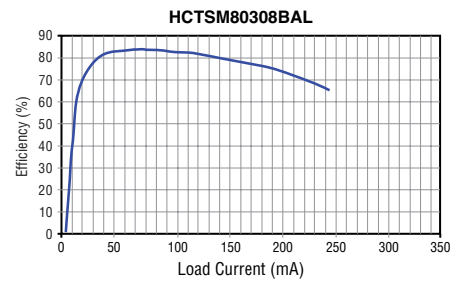
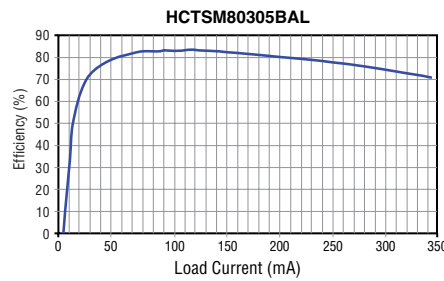
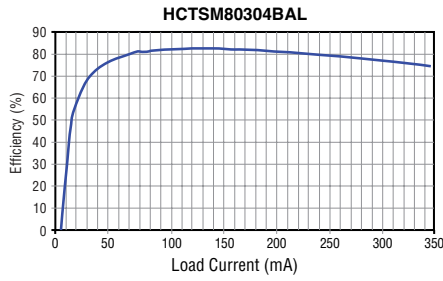
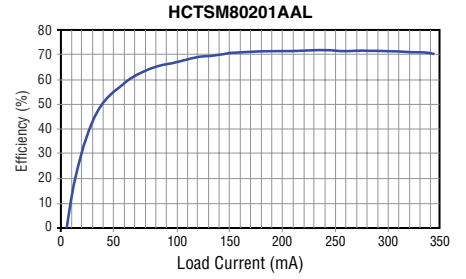
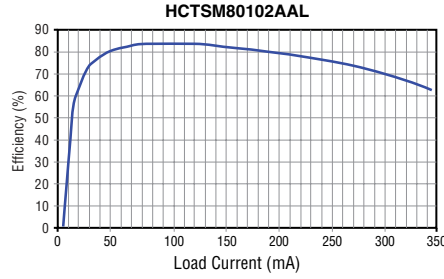
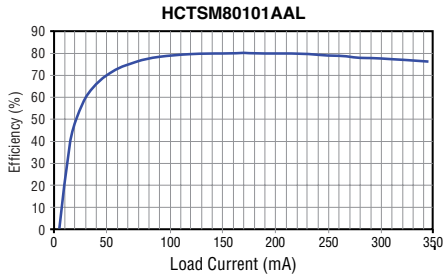

*Measured with circuit in Typical Application, 5 VDC input, 0-350 mA DC load, $T_a = 20\text{ }^\circ\text{C}$

Specifications are subject to change without notice.

Users should verify actual device performance in their specific applications.

The products described herein and this document are subject to specific legal disclaimers as set forth on the last page of this document, and at www.bourns.com/docs/legal/disclaimer.pdf.

HCT Series - High Clearance and Creepage Distance Transformers

BOURNS®

Packaging Specifications

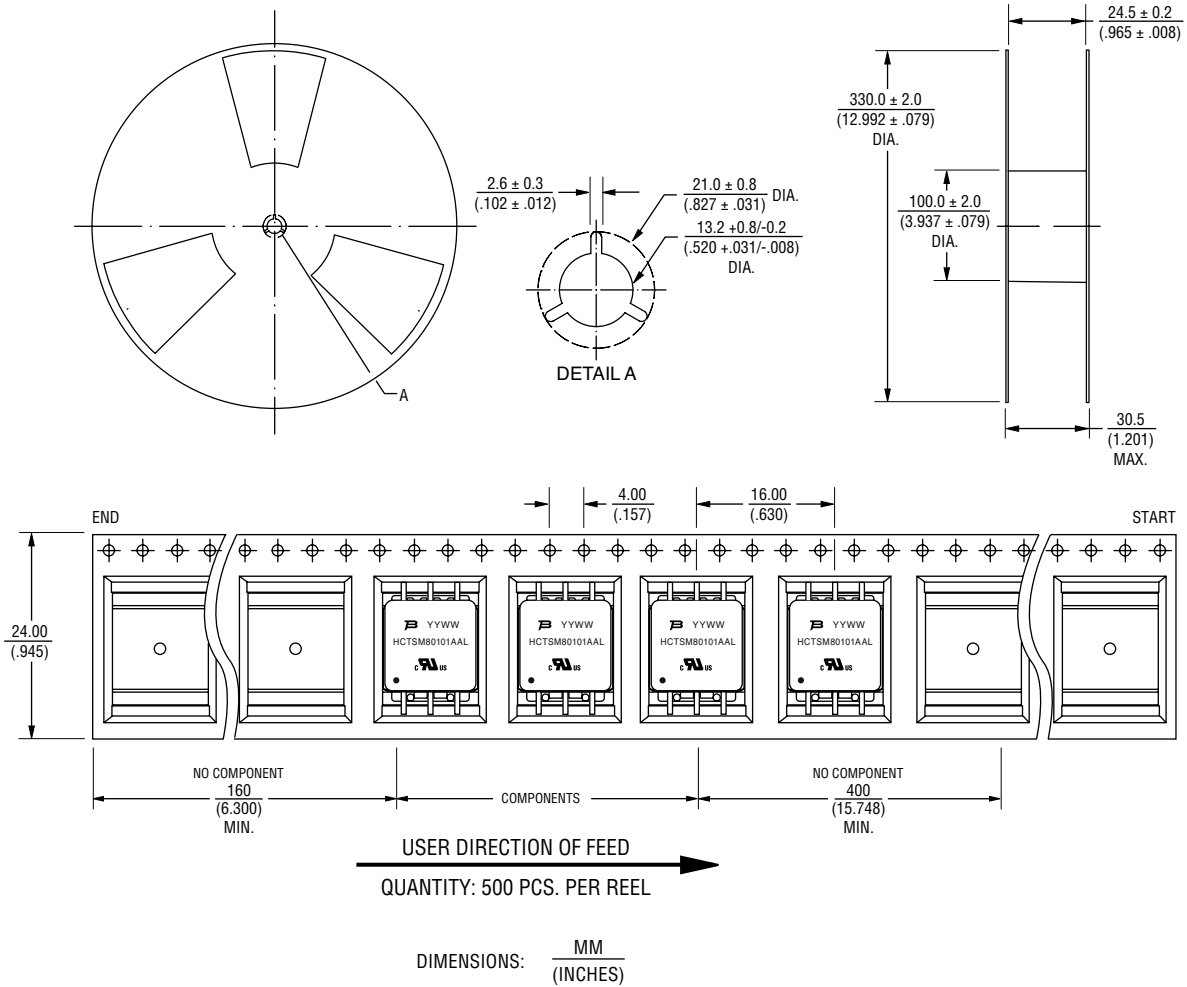

REV. EFFECTIVE 6/14/21

Specifications are subject to change without notice.

Users should verify actual device performance in their specific applications.

The products described herein and this document are subject to specific legal disclaimers as set forth on the last page of this document, and at www.bourns.com/docs/legal/disclaimer.pdf.