



Product Name: 5G NR FR1 Ceramic Chip Antenna – CX40D9

Part Number: H2UN3P1D2V0100

Features:

- Supporting 5G NR FR1 Bands, covering 600 to 6000 MHz
- Surface Mount
- Dimensions: 40 x 5 x 6 mm
- High performance, small size.
- RoHS & REACH Compliant

Applications:

- Transportation
- Autonomous/UAVs
- Industrial IoT
- Trackers/CPEs



5G NR FR1 Ceramic Chip Antenna

MODEL: CX40D9

Version: B

I. Specifications:

Items	Specifications					
5G Bands	N5, N8, N20, N28, N71, N81, N82, N83	N1, N2, N3, N25, N34, N38, N39, N66, N70, N80, N84, N86	N7, N38, N40, N41	N77, N78	N79	-
4G Bands	B5, B6, B8, B12, B13, B14, B17, B18, B19, B20, B26, B27, B28, B29, B44, B67, B68, B71, B85	B1, B2, B3, B4, B9, B10, B15, B16, B25, B33, B34, B35, B36, B37, B39	B7, B15, B16, B38, B40, B41	B42, B43	-	B46, B47, B252, B255
Frequencies (MHz)	617~960	1710~2170	2300~2690	3300~4200	4400~5000	5150~5925
Efficiency (%)	~63	~78	~62	~61	~48	~37
Average Gain (dB)	~-2.1	~-1.1	~-2.2	~-2.2	~-3.4	~-4.5
Peak Gain (dBi)	~-0.5	~-2.9	~-3.0	~-2.5	~-0.7	~-1.3
Test Condition	120 x 45 mm ² (Evaluation board)					
Impedance (Ω)	50					
Polarization	Linear Polarization					

© Unictron Technologies Corp.
All specifications subject to change without notice.

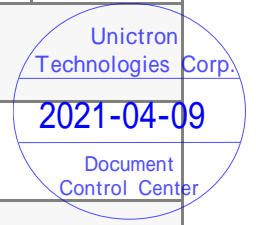

Mechanical Specifications	
Dimensions (mm)	40(L) x 5 (W) x 6 (H)
Material	Ceramic
Termination	Ag (environmental Pb free)
Environmental Conditions	
Operation Temperature (°C)	-40 ~ +85
Storage Temperature (°C)	-5 ~ +40
Relative Humidity	10 ~ 70 %

II. Layout Guide:

Solder Land Pattern:

The solder land pattern (gold marking areas) is shown below. Recommendation on matching circuit will be provided according to customer's installation conditions.

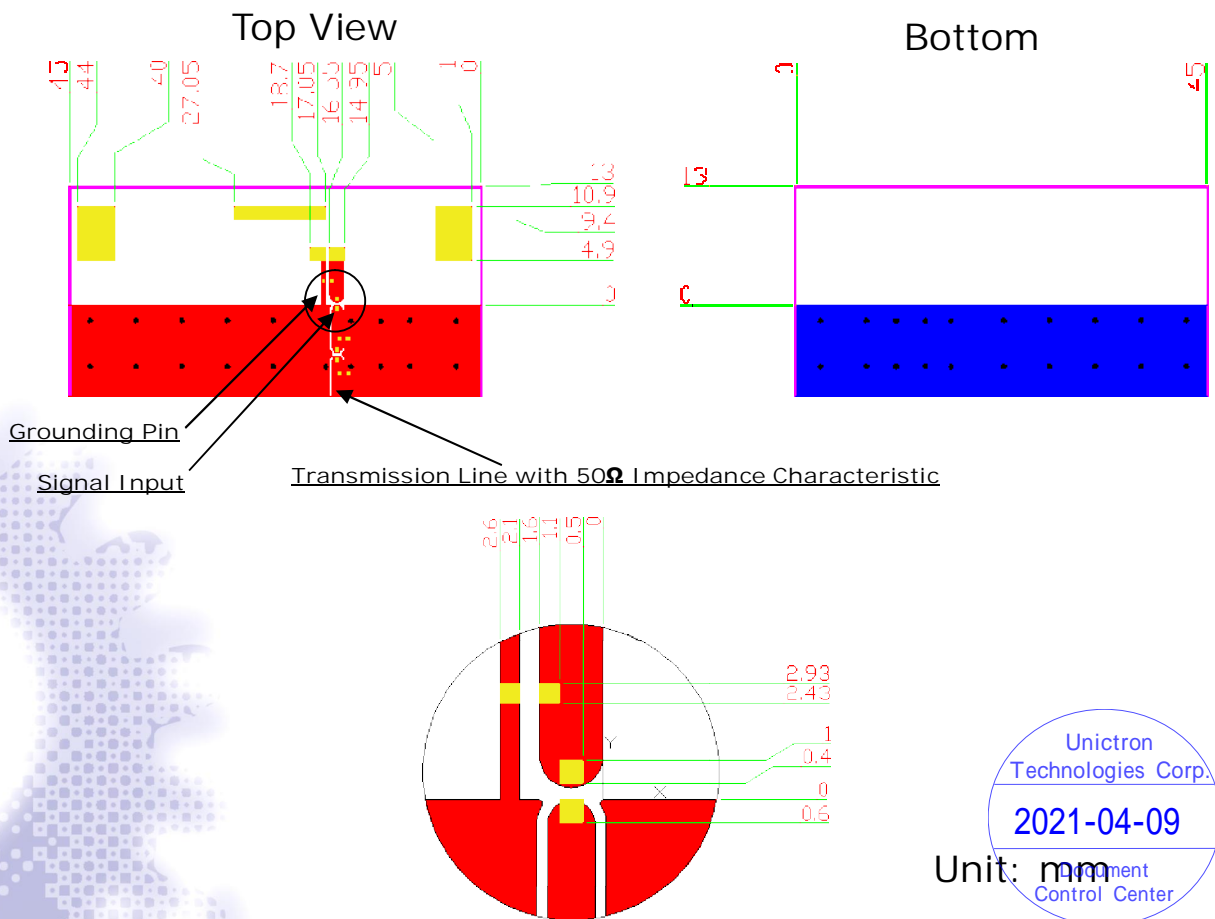

Unictron
Technologies Corp.
2021-04-09
Unit: mm
Management
Control Center

III. Mechanical Dimensions (Unit: mm):

a) Antenna Dimensions

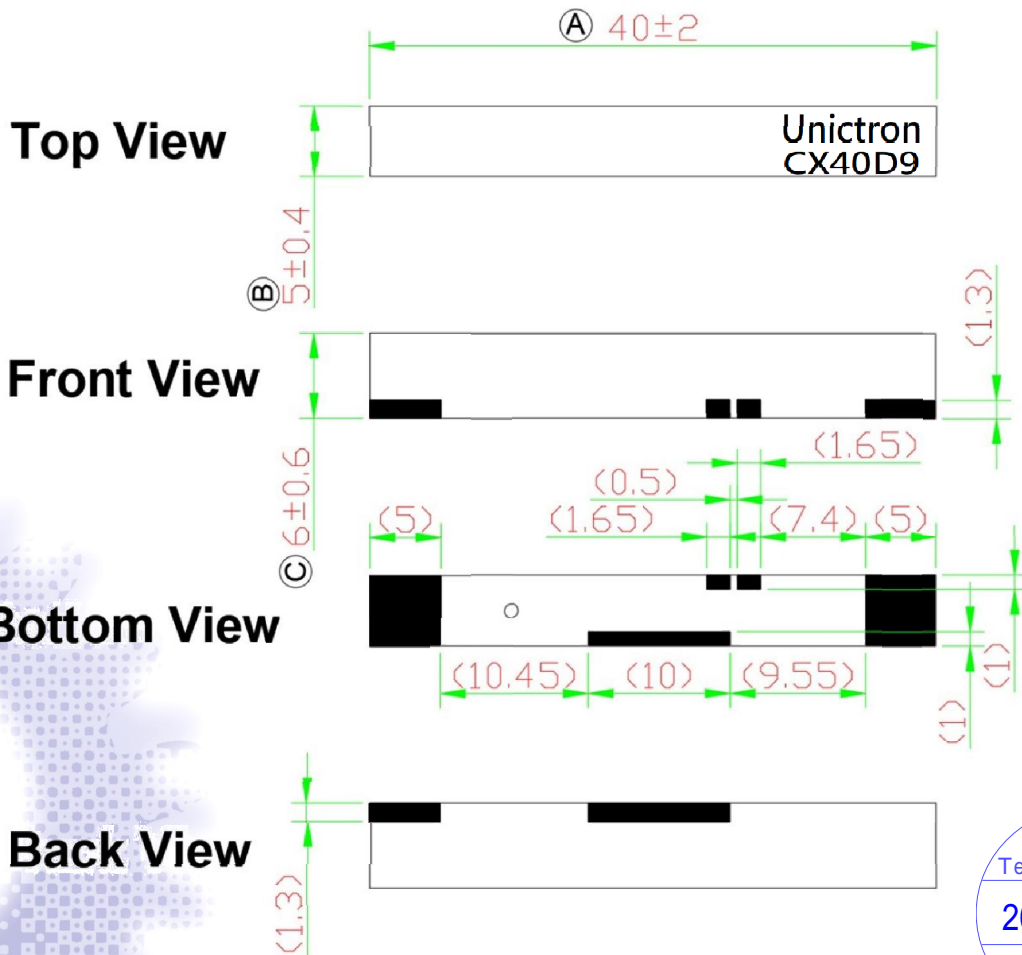
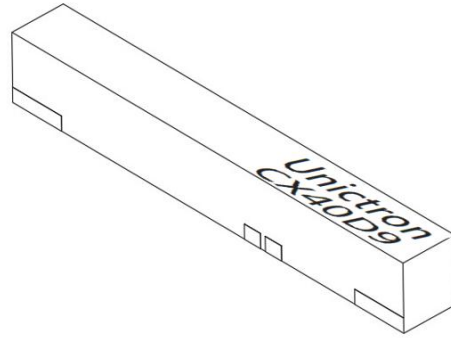

Unictron
Technologies Corp.
2021-04-09
Document
Control Center

© Unictron Technologies Corp.
All specifications subject to change without notice.

b) PIN Definition

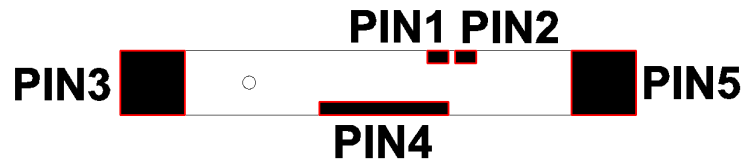

Bottom View

PIN	1	2	3~5
Soldering Pad	Tuning/Ground	Signal	Fixing

© Unictron Technologies Corp.
All specifications subject to change without notice.

c) Evaluation Board & Antenna's Location

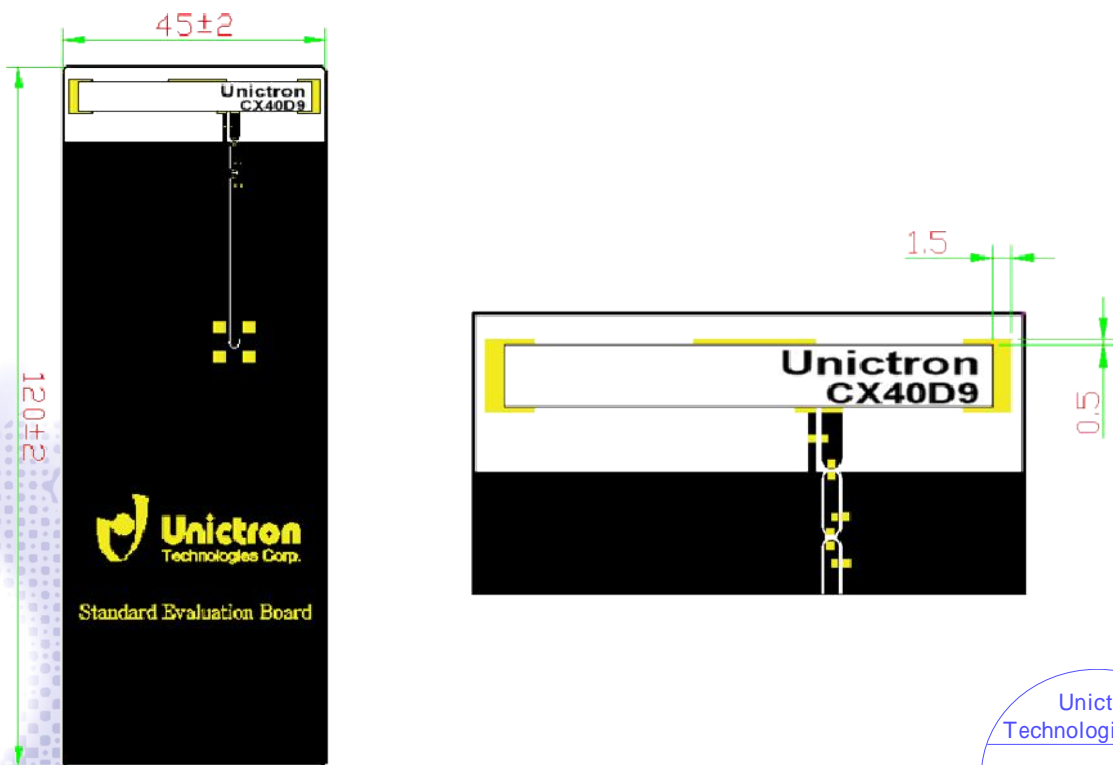

Unictron
Technologies Corp.
2021-04-09
Document
Control Center

IV. Properties:

a) Return loss (dB)

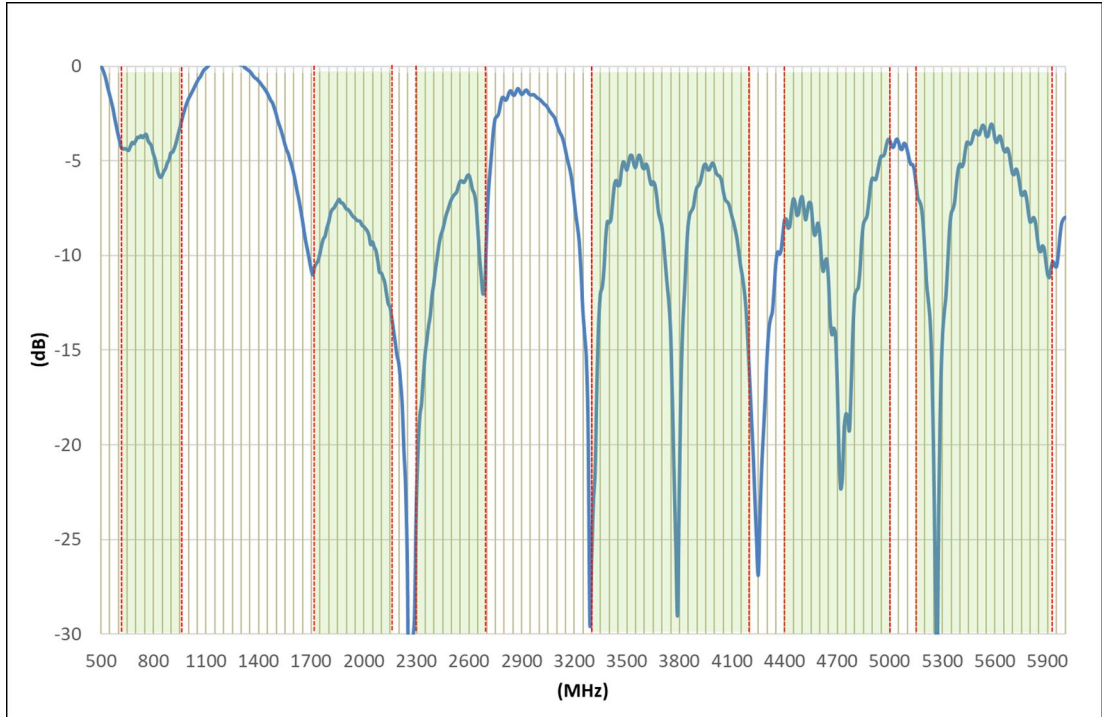

b) Efficiency (%)

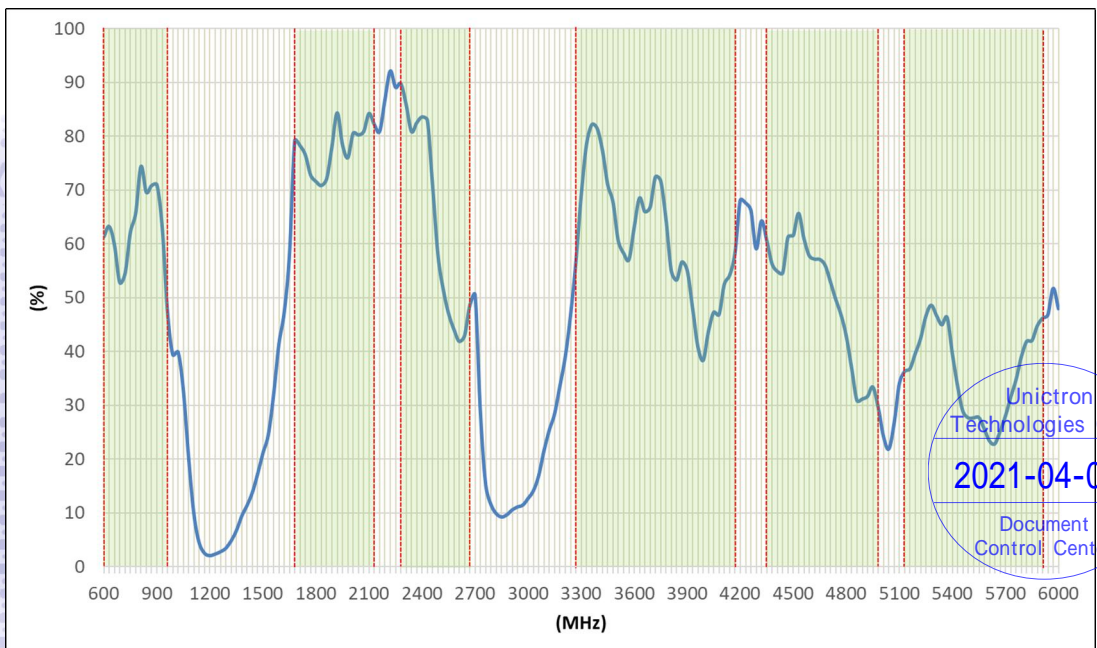

© Unictron Technologies Corp.
All specifications subject to change without notice.

c) Average Gain (dB)

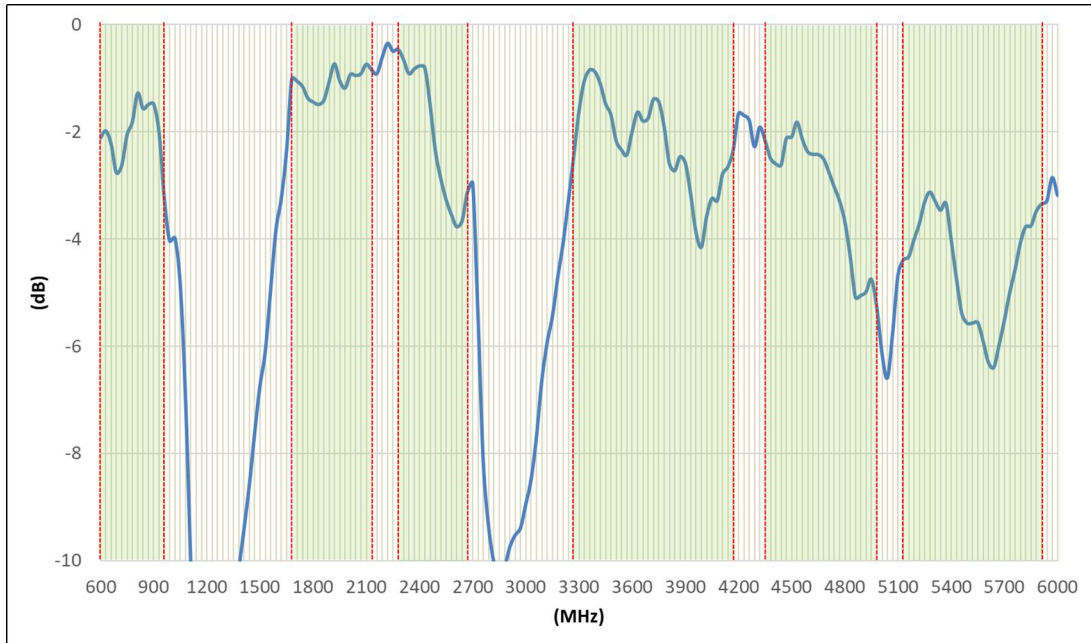

© Unictron Technologies Corp.
All specifications subject to change without notice.

d) Peak Gain (dBi)

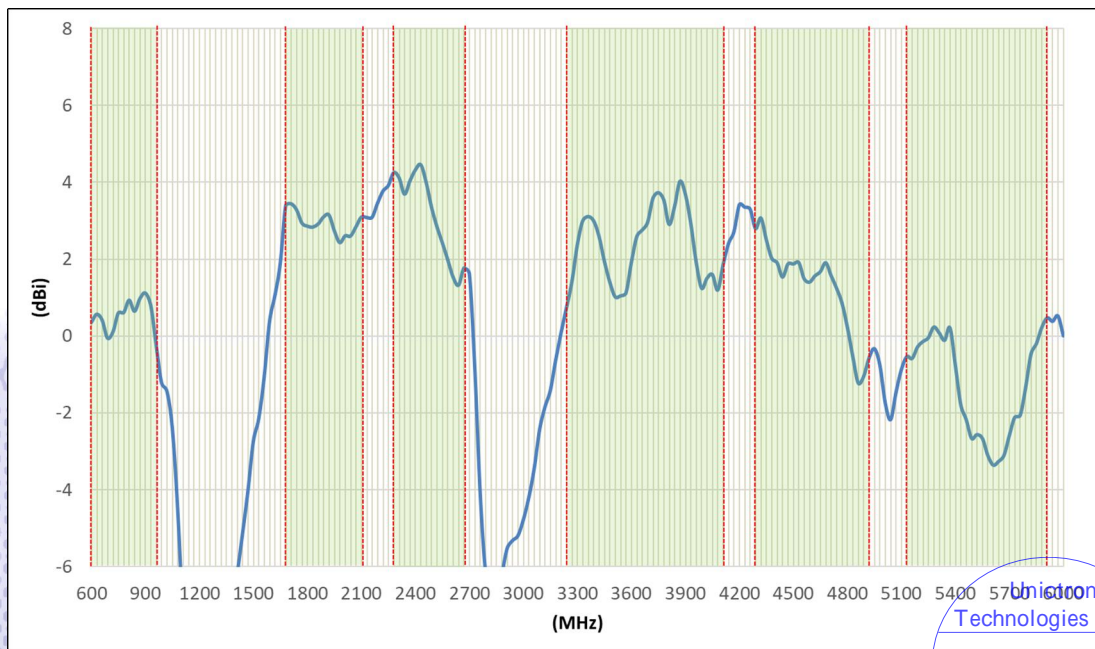

Unictron
Technologies Corp.

2021-04-09

Document
Control Center

V. Antenna Radiation Pattern Measurement:

The antenna radiation patterns are measured in Unictron's 3D Anechoic Chamber. The measurement setup is as show below.

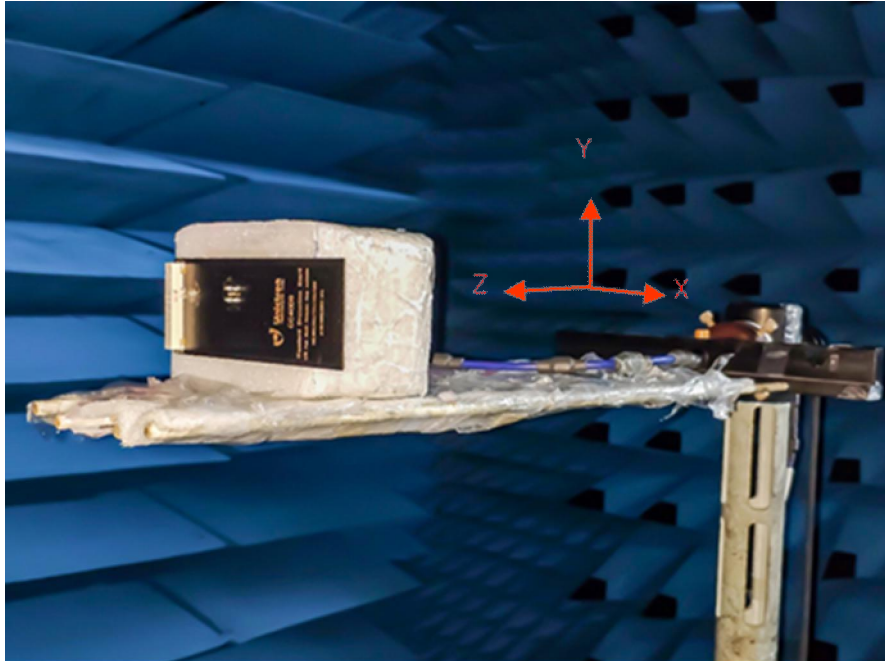

© Unictron Technologies Corp.
All specifications subject to change without notice.

3D Radiation Gain Pattern

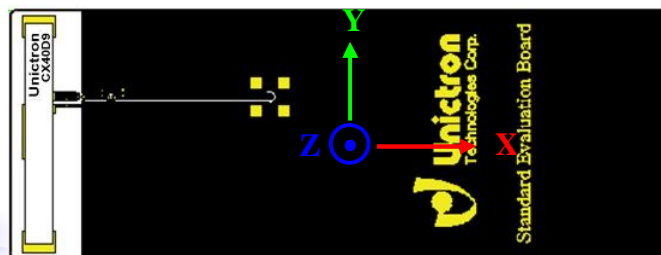

a) 660 MHz (unit: dBi)

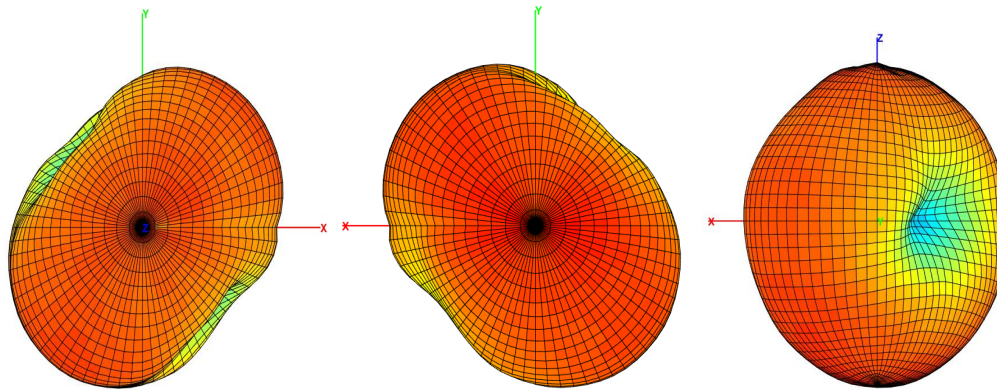

b) 800 MHz (unit: dBi)

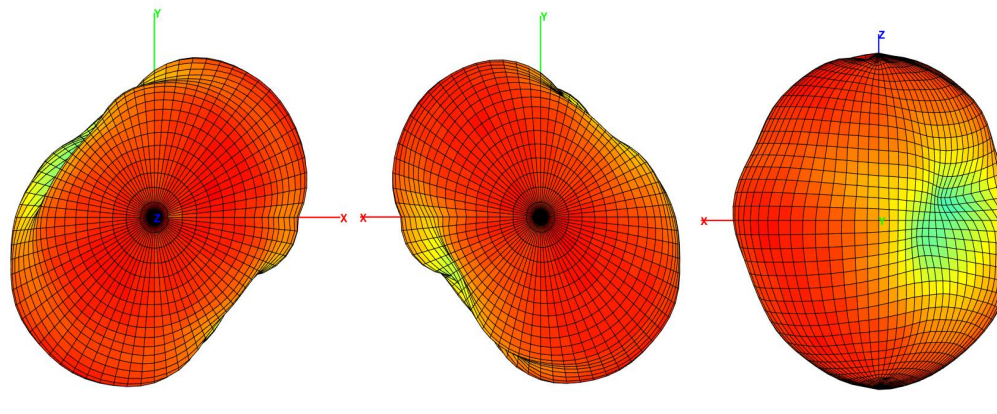

c) 960 MHz (unit: dBi)

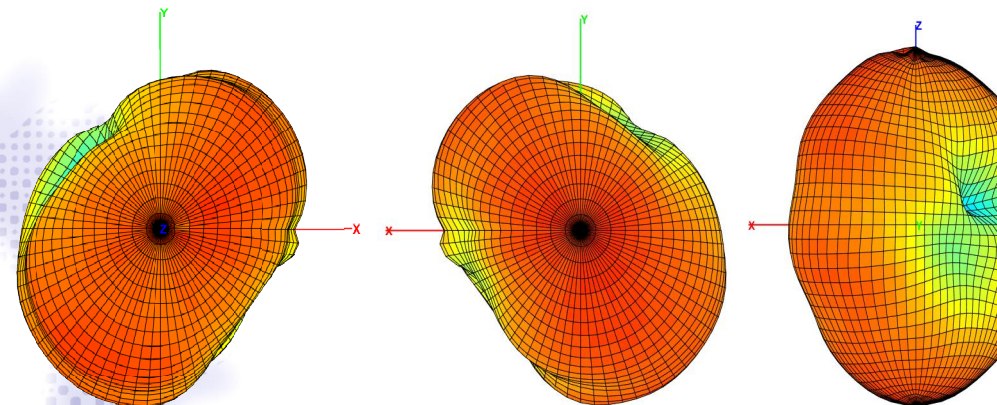

© Unictron Technologies Corp.
All specifications subject to change without notice.

Unictron
Technologies Corp.
2021-04-09
Document
Control Center

d) 1710 MHz (unit: dBi)

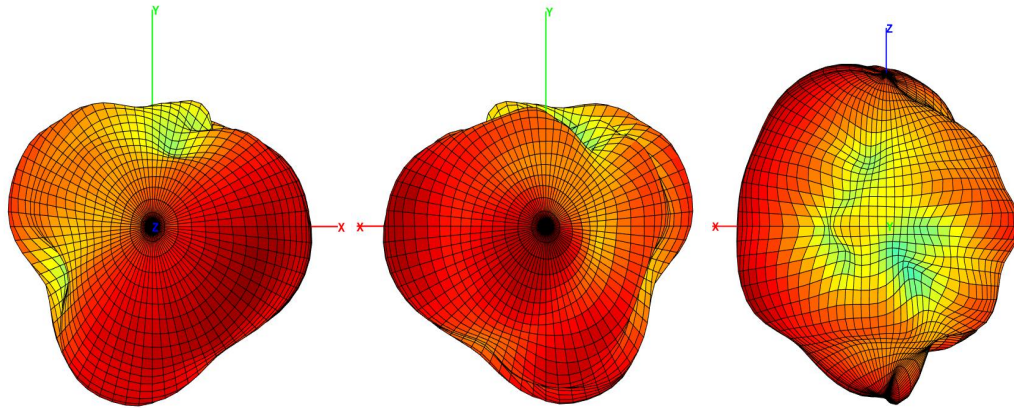

© Unictron Technologies Corp.
All specifications subject to change without notice.

e) 1950 MHz (unit: dBi)

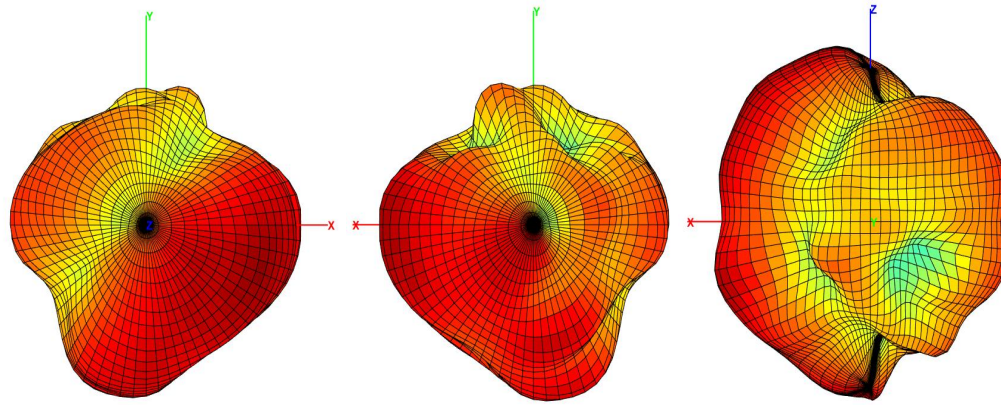

f) 2170 MHz (unit: dBi)

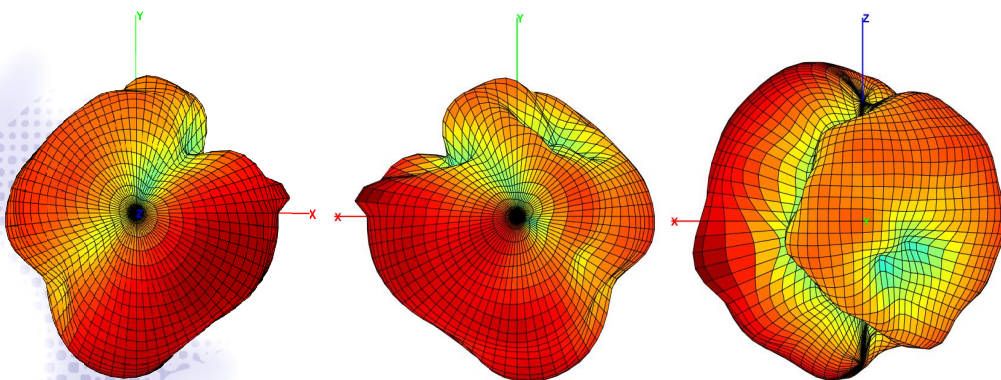

Unictron
Technologies Corp.
2021-04-09
Document
Control Center

g) 2340 MHz (unit: dBi)

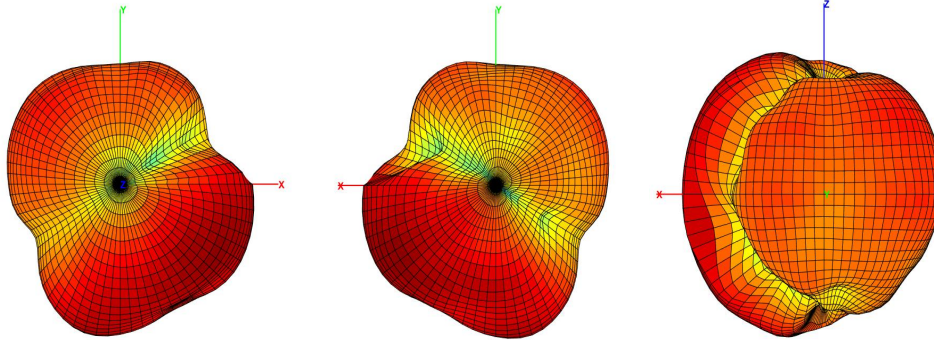

h) 2490 MHz (unit: dBi)

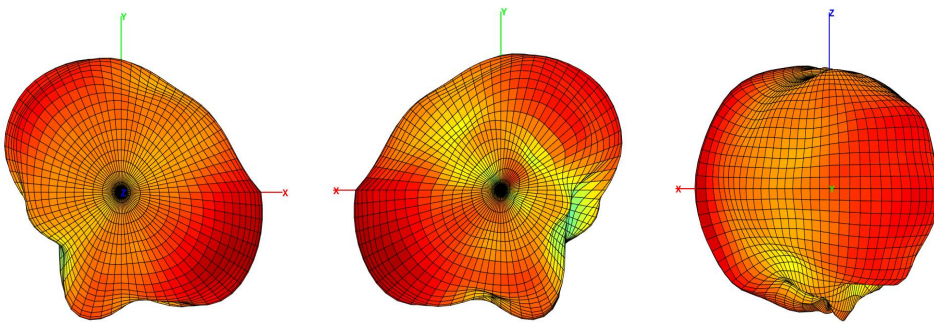

i) 3600 MHz (unit: dBi)

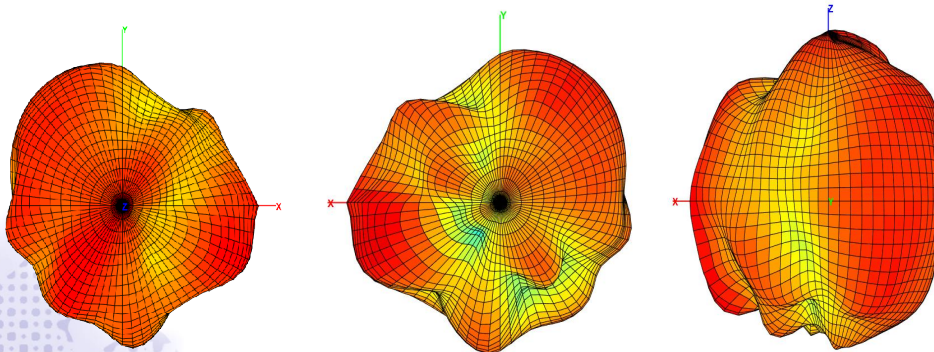

j) 4500 MHz (unit: dBi)

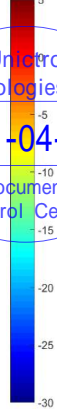
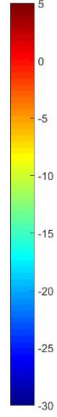
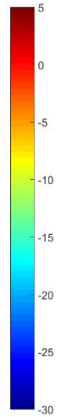
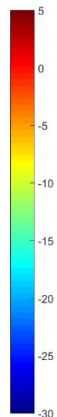
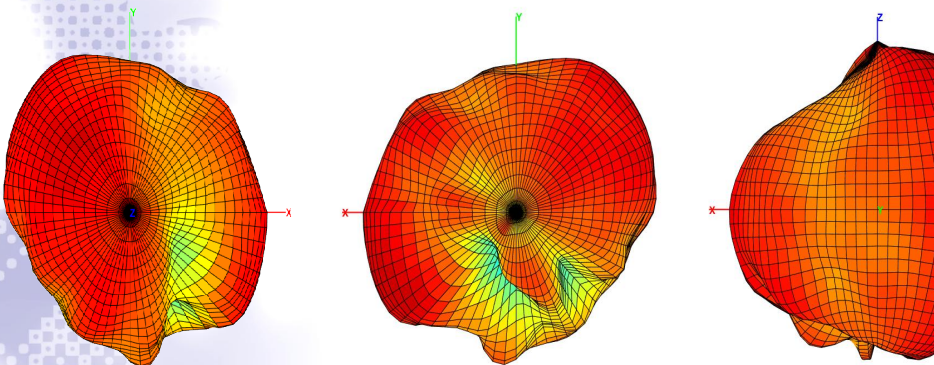

© Unictron Technologies Corp.
All specifications subject to change without notice.

Unictron
Technologies Corp.
2021-04-09
Document
Control Center

VI. Frequency tuning:

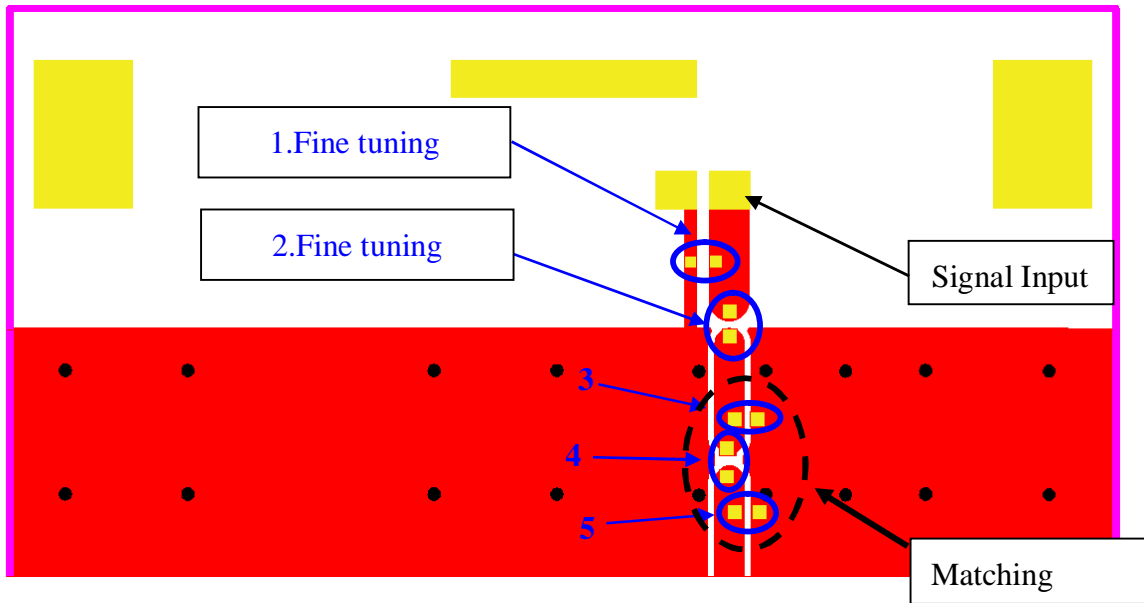

© Unictron Technologies Corp.
All specifications subject to change without notice.

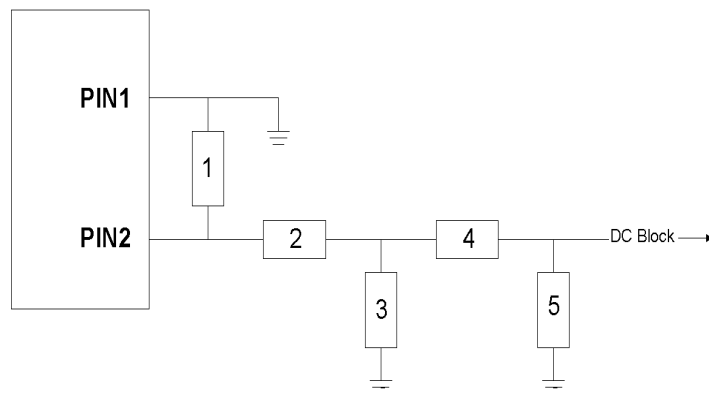

System Matching Circuit Component			
Location	Description	Vendor	Tolerance
1	6.8 nH (0402)	MURATA	±0.1 nH
2	6.8 pF (0402)	MURATA	±0.05 pF
3	N/C	-	-
4	0Ω (0402)	-	-
5	N/C	-	-

Unictron
Technologies Corp.
2021-04-09
Document
Control Center

VII. Soldering conditions:

Typical Soldering Profile for Lead-free Process

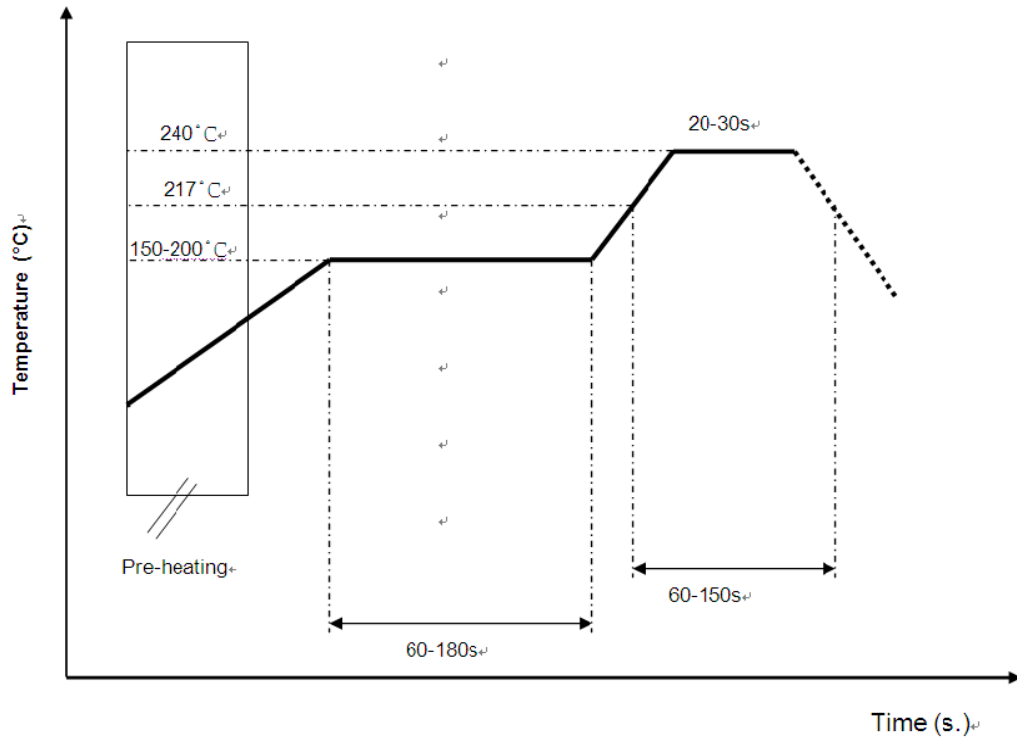

© Unictron Technologies Corp.
All specifications subject to change without notice.

*Recommended solder paste alloy: SAC305 (Sn96.5 /Ag3 /Cu0.5) Lead Free solder paste.

VIII. Reminders for use of Unictron's ceramic chip antennas:

- a) This chip antenna is made of ceramic materials which is relatively more rigid and brittle compared to circuit board materials. Furthermore, the length of this antenna is quite long. Bending of circuit board at the locations where chip antenna is mounted may cause the cracking of solder joints or antenna itself.
- b) Punching/cutting of the break-off tab of PCB panel may cause severe bending of the circuit board which may result in cracking of solder joints or chip antenna itself. Therefore break-off tab shall be located away from the installation site of chip antenna.
- c) Be cautious when ultrasonic welding process needs to be used near the locations where chip antennas are installed. Strong ultrasonic vibration may cause the cracking of chip antenna solder joints.

Unictron
Technologies Corp.
2021-04-09
Document
Control Center

IX. Packing: (Unit: mm)

a. Reel Dimensions

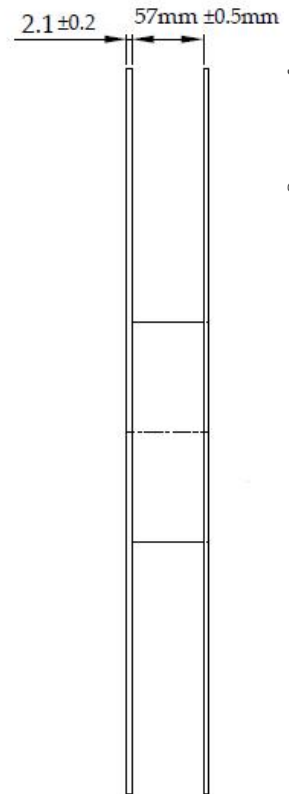
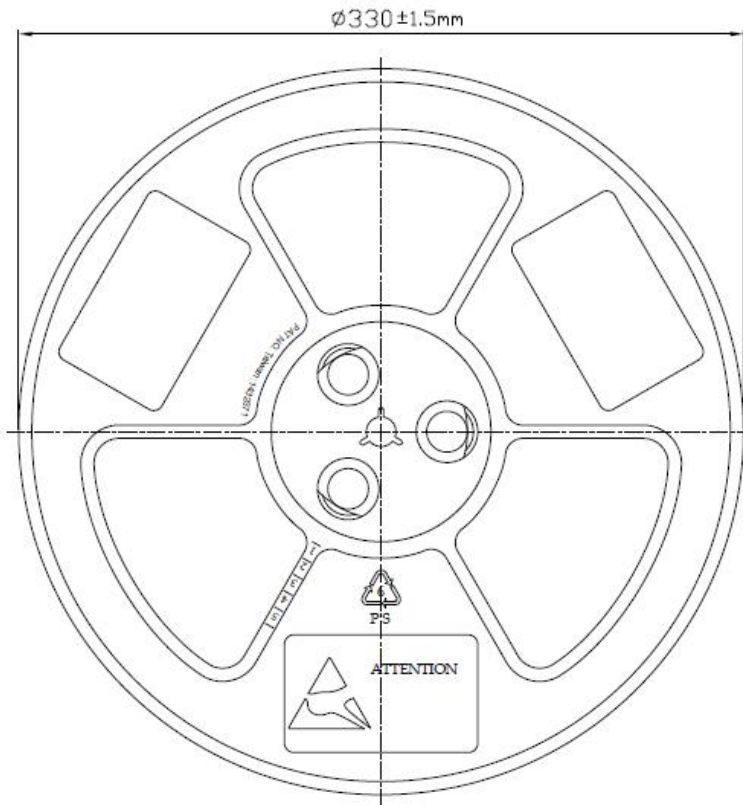

© Unictron Technologies Corp.
All specifications subject to change without notice.

b. Tape Drawing

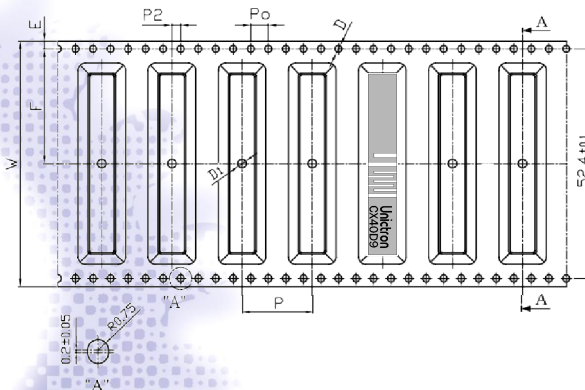

c. Tape Dimensions

Feature	Specifications	Tolerances
W	56.00	± 0.30
P	16.00	± 0.10
E	1.75	± 0.10
F	26.20	± 0.15
P2	2.00	± 0.15
D	1.50	$+0.10$ -0.00
D1	2.00	± 0.10
Po	4.00	± 0.10
10Po	40.00	± 0.20

- d. (1) Weight: 1 pcs / 4.0g typ
1 Reel / 3.1Kg typ
- (2) Quantity/Reel: 600 pcs/Reel
- (3) Plastic tape: Clear Non Anti-static Polystyrene



- e. (1) Weight: 2 Reel /1 carton 6.8Kg typ
- (2) 2 Reel / 1200 pcs in one carton
- (3) Carton Dimensions – 340*350*200 mm

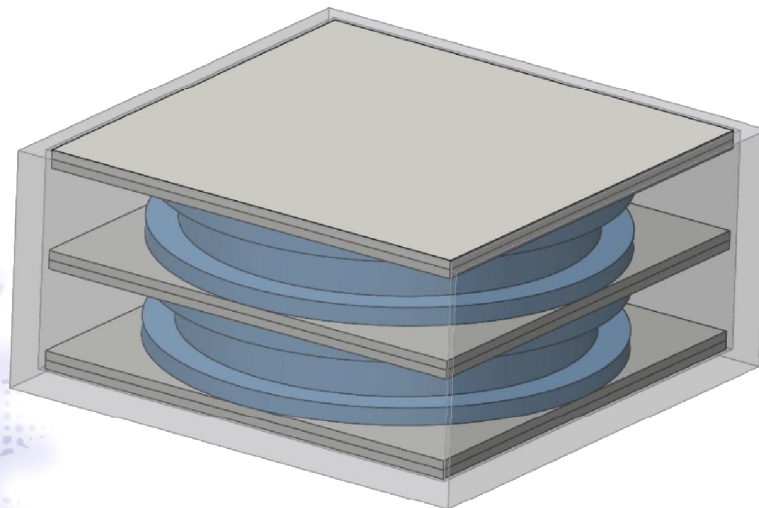

X. Operating & Storage conditions:

a) Operating

- (1) Maximum Input Power: 2 W
- (2) Operating Temperature: -40°C to 85°C
- (3) Relative Humidity: 10% to 70%

b) Storage (sealed)

- (1) Storage Temperature: -5°C to 40°C
- (2) Relative Humidity: 20% to 70%
- (3) Shelf Life: 1 year

c) Storage (unsealed)

Meet the criteria of J-STD-033 MSL2a

d) Storage (After mounted on customer's PCB with SMT process)

- (1) Storage Temperature: -40°C to 85°C
- (2) Relative Humidity: 10% to 70%

XI. Notice

(1) Installation Guide:

Please refer to Unictron's application note "General guidelines for the installation of Unictron's chip antennas" for further information.

(2) All specifications are subject to change without notice.



XII. Reliability Test

Test Items	Test Conditions	Result
1. Solderability	* Solder Temperature : 250 ± 5°C * Test time: 2 +/- 0.5 sec * With solder paste	Pass
2. Temperature cycling	-40°C/ 30min~90°C /30min Total <u>10</u> cycles * Specimens are kept at standard measurement environment for more than 24 hours before testing.	Pass
3. Damp heat	* Humidity: 90~95% * Temperature: 85°C * Test time : 240 hours * Specimens are kept at standard measurement environment for more than 24 hours before testing..	Pass
4. Adhesive strength of terminal electrodes	* Resistance to bending of printed-circuit test board(110x40x1.6mm) * Applied force: 5Kgf ; * Duration : 10±1sec	Pass
5. High temperature exposure	* Temperature : 90°C * Test duration : 240 hours * Specimens are kept at standard measurement environment for more than 24 hours before testing.	Pass
6. Low temperature exposure	* Temperature : -40°C * Test duration : 240 hours * Specimens are kept at standard measurement environment for more than 24 hours before testing.	Pass

© Unictron Technologies Corp.
All specifications subject to change without notice.

