

VLM-520-57-45°Series

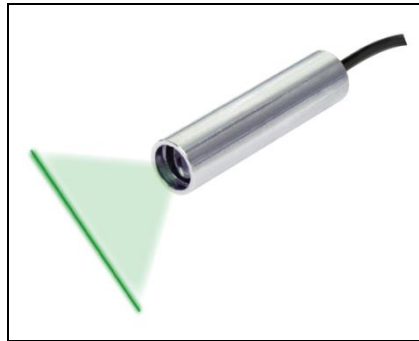

The newly developed glass line lens come with various fan angles and they produce high quality uniform laser line in a robust stainless housing, ideal for automation, machine vision, image processing, digital data acquisition, counting, precision 3D scanner and science & medical application. They are all come with TTL function to allow up to 10K Hz modulation frequency. They are available at 10 cm, 20 cm, 40 cm and 90 cm focus length, red & green wavelength, Class 1M and Class 2M laser class to cover within 1 meter range task. For customized focus length, wavelength and laser power output, please contact us.

FEATURES:

- Built with high precision glass line lens and glass laser collimating lens.
- Fan Angle : 45°
- Focus range: 10cm, 20cm, 40cm, 90cm, customized focus length are available by request.
- CW to 10K HZ stable power output for demanding power and speed are of important.
- Customized focus within 1 meter available please direct contact us.
- Two laser power output level: LPO - Class 1M laser product
LPT - Class 2M laser product
- Dimensions : Ø10 x 40 mm (Ø0.39" x 1.575")
- Wavelength : 515~530 nm
- 3~6 VDC operation.
- Connection type : Lead wire
- Laser line demonstration : https://www.youtube.com/watch?v=3_gRtxyeP28

APPLICATIONS: ideal for

- Machine vision.
- Automation industry.
- Image processing.
- Medical & Science.
- Scanning.
- Precision 3D scanner.
- Counting.
- Measurement.

VLM-520-57-45°Series

OUTLINE DIMENSIONS (UNITS: mm)

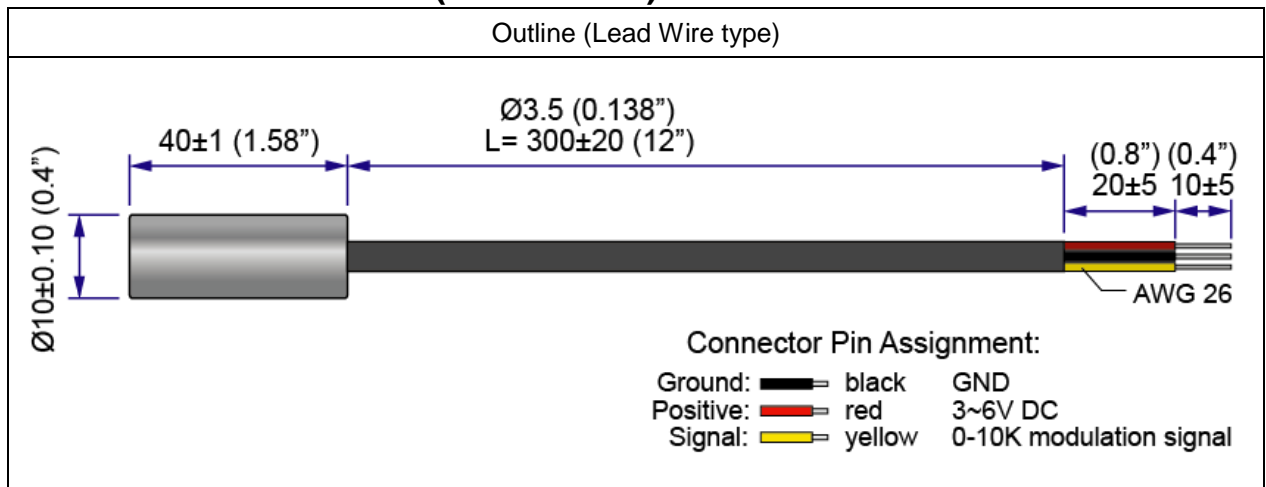

SPECIFICATIONS

Part Number		VLM-520-57 LPO-D45-				VLM-520-57 LPT-D45-			
		F10	F20	F40	F90	F10	F20	F40	F90
1	Focus length	10 cm	20 cm	40 cm	90 cm	10 cm	20 cm	40 cm	90 cm
2	Fan angle / Laser line length	45° / Length of Laser Line as TABLE A							
3	Laser line width	AS TABLE B							
4	Recommended working range	AS TABLE B							
5	TTL modulation frequency	High ON, 0-10K Hz							
6	Dimensions	$\text{Ø}10 \times 40$ mm ($\text{Ø}0.39" \times 1.575"$)							
7	Weight	18±1g							
8	Operating voltage (Vop)	3~6 VDC							
9	Operating current (Iop)	Less than 80mA				Less than 180mA			
10	Optical power*	Less than 10mW				Less than 30mW			
11	Laser power output**	Less than 0.39mW				Less than 1mW			
12	Laser class	Class 1M				Class 2M			
13	Wavelength (λ p)	515~530nm							
14	Collimating lens / Line generating lens	Aspherical glass lens							
15	Output aperture	8mm							
16	Beam shape	Line							
17	Laser line accuracy	40"(± 1 mm@5M)							
18	Operating temp. range***	-20°C ~+60°C							
19	Storage temp. range	-20°C ~+85°C							
20	Housing material / color	Stainless steel / Silver							
21	Potential of housing	Insulated							

VLM-520-57-45°Series

22	Electrostatic discharge (ESD)	30KV
23	Moisture sensitivity level (MSL)	Level 1 - acc to JEDEC J-STD-020E.
24	Wire type	2464 3-WIRE CABLE 26 AWG
25	Cable length	330±30mm
26	Mean time to failure (MTTF) 25°C	Above 10000 hrs
27	International Protection Marking	IP65
28	Application	Precision fine line for Automation, Machine vision and Medical with modulation function
29	Suggestion work distance	0~1.2 meters / 0~4 feet

- * Optical power is total power output measured at the aperture of the laser.
- ** According to FDA 1040.10 & IEC 60825-1 regulations, laser power output is measured by 7mm aperture stop from a 10 cm distance of the laser.
- *** Operation temperature means within this temperature range, the laser spot/line will not be affected to change the spot size/line width. It can still work over this range, but the laser spot size or laser line width will be larger.

SAFETY LABEL

LPO:

CLASS I LASER PRODUCT

LPT:



TABLE A: Laser Line Length Table:

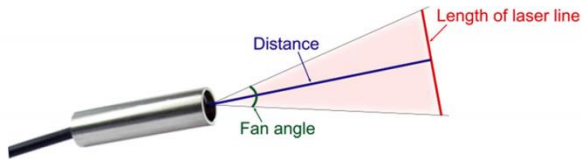

Length of laser line:

Distance Fan angle	10 cm (4 inch)	20 cm (8 inch)	40 cm (16 inch)	100 cm (40 inch)
5°	0.9 cm (0.35")	1.75 cm (0.7")	3.5 cm (1.4")	7.85 cm (3")
10°	1.75cm (0.6")	3.5 cm (1.4")	7 cm (2.8")	17.5 cm (6")
15°	2.6 cm (1")	5.2 cm (2")	10.5 cm (4")	26.3 cm (10")
20°	3.5 cm (1.4")	7 cm (2.8")	14 cm (5.6")	35 cm (14")
30°	5.3 cm (2")	10.7 cm (4")	21 cm (8")	53.5 cm (20")
45°	8.28 cm (3¼")	16.6 cm (6½")	33.1 cm (13")	82.85 cm (32½")
60°	11.5 cm (4½")	23 cm (9")	46 cm (18")	115.5 cm (45")
110°	28.6 cm (11¼")	57.1 cm (23")	114.2 cm (46")	285.6 cm (112½")

VLM-520-57-45°Series

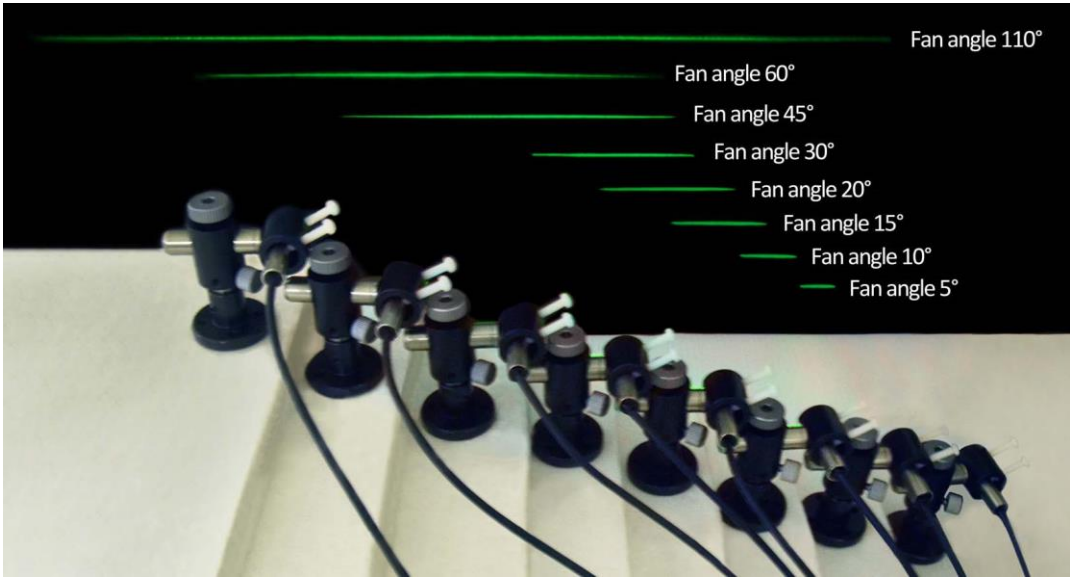

TABLE B: Recommended working range:

Focus at 10 cm:

Working range: 0 - 19cm(0-7.5")

Best at: 5.5 - 15cm(2.2"-5.9") Laser Line Width <1mm
 Laser Line Width <2mm

Laser Fan Angle	Recommended Working Range(cm)				
	5	10	15	20	25
5°	6.5 - 16 -21				
10°	8 - 15 -19				
15°	6- 8 - 15 -19				
20°	4- 7 - 16 -21.5				
30°	4- 6 - 14.5 -21				
45°	0- 5.5 - 15 -19				
60°	0- 7 - 14.5 -20				
110°	0- 7 - 16.5 -22.5				

Focus at 20 cm:

Working range: 9 - 34cm(3.5"-13.4")

Best at: 13 - 24cm(5.1"-9.5") Laser Line Width <1mm
 Laser Line Width <2mm

Laser Fan Angle	Recommended Working Range(cm)				
	10	15	20	25	30
5°	12.5- 15 - 23 -26				
10°	10- 14 - 22 -26				
15°	10- 14.5 - 22 -26				
20°	10- 14.5 - 23 -27				
30°	10- 14 - 22 -26				
45°	9- 13 - 24 -34				
60°	11- 15 - 23.5 -32				
110°	8- 12.5 - 23 -30				

Focus at 40 cm:

Working range: 4 - 69cm(1.6"-27.2")

Best at: 22 - 56cm(8.7"-22") Laser Line Width <1mm
 Laser Line Width <2mm

Laser Fan Angle	Recommended Working Range(cm)				
	15	30	45	60	75
5°	11- 20.5 - 57 -75				
10°	11.5- 22 - 47.5 -61.5				
15°	7- 21 - 53 -64				
20°	6- 21 - 54 -68				
30°	5- 21 - 54 -68				
45°	4- 22 - 56 -69				
60°	3- 20 - 58 -72				
110°	3- 21 - 58 -82				

Focus at 90 cm:

Working range: 40 - 139cm(15.7"-54.7")

Best at: 55 - 120cm(21.7"-47.2") Laser Line Width <1mm
 Laser Line Width <2mm

Laser Fan Angle	Recommended Working Range(cm)				
	40	65	90	115	140
5°	29- 45 - 91 -109				
10°	35- 57 - 119 -146				
15°	31- 57 - 119 -140				
20°	31- 59 - 122 -142				
30°	42- 60 - 114 -144				
45°	40- 55 - 120 -139				
60°	35- 56 - 116 -145				
110°	38- 60 - 106 -134				

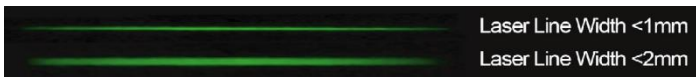

Optional Accessories

Quarton offers mounts, power supply boards, battery pack and USB cable switch to help you running as quickly as possible. For more information, please visit www.quarton.com, www.quarton.com/contact or email contact@quarton.com.

QLM-1125 - Laser Module Mount/Holder for diameter 6mm to 12.5mm, it's an ideal choose for mounted onto optical tables.

Feature:

- 4 directions adjustable.
- Can be mounted onto the optical table with screws (Screws not included).
- Engraved scale for precision adjustable.



LMPS-MP1 - Multi-function Laser Module Power Supply Board.

Four input : USB, micro USB, DC Power Jack(5.5 x 2.1), and terminal block. Two channel output : 7 VDC 500mA and 5 VDC 1A. Three switches-toggle switch, remote switch and TTL signal.

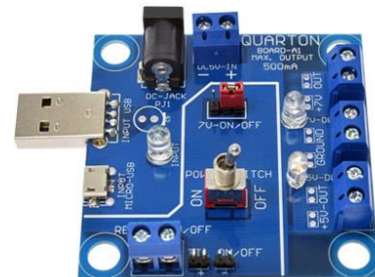

Feature:

- Allow four kinds of power input: USB, micro USB, DC Power Jack(5.5x2.1) and terminal block.
- Two Channel output: 7 VDC 500mA and 5 VDC 1A.
- Built-in three switches: toggle switch, terminal block remote switch and TTL signal switch by on-board connect point.
- 7 VDC output work for all Quarton Laser Modules with 7-12 V operation Voltage (Vop).
- 5 VDC output work for all Quarton Laser Modules with 3-6 V operation Voltage (Vop).
- Three LED indicators: Input power indicator, 7V output indicator and 5V output indicator.

Optional Accessories

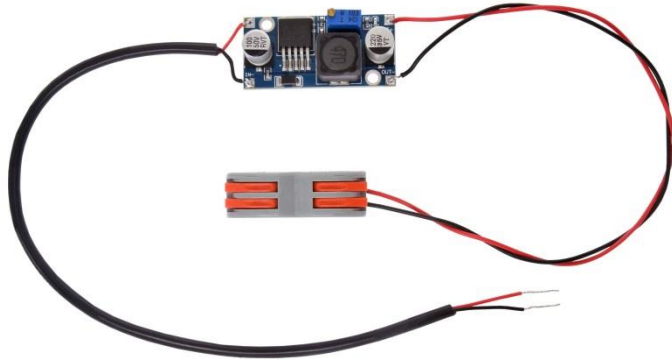

LMPS-MP2 - DC converter, In: 9-36V, Out: 5V 1A.



LMPS-mUSB1 - Laser Module Power Supply Board, Input: micro USB, Output: 5 VDC 500mA.

Feature:

- Micro USB connector power input.
- Output 5 VDC 500mA with alligator clips.
- For all Quarton Laser Modules that require 3-6V operation Voltage.



LMPS-DC1 - Laser Module Power Supply Board, Input: DC Power Jack(5.5 x 2.1), Output: 5 VDC 500mA.

Feature:

- DC Power Jack(5.5 x 2.1) power input.
- Output 5 VDC 500mA with alligator clips.
- For all Quarton Laser Modules that require 3-6V operation voltage.

Optional Accessories



CLM-BP4N3 - Battery pack (4* AA batteries)

*** AA Batteries are **NOT** included in package.

Feature:

- USB Output Voltage: 5 VDC.
- Color: Black.



CLM-USBSW - USB Cable Switch.

Feature:

- Length: 28cm.
- Color: Black.



CLM-UM3M - USB to micro USB Cable.

Feature:

- Length: 3 meters.
- Color: Black.