



TAOGLAS®



Datasheet

GWLA.01

Description:

GPS L1/GALILEO & Bluetooth/Wi-Fi 2.4GHz
Embedded 2in1 Ceramic Loop Antenna

Features:

- High Efficiency
- Omnidirectional
- Simplifies GPS/GALILEO and 2.4GHz Circuits
- Multi-Band Application
- 1575.42MHz and 2.4GHz
- Two Separate feeds on one antenna
- Low Profile
- 3.2*1.6*0.5mm
- Economical
- Compact Size
- Surface-Mount
- RoHS & Reach Compliant

1. Introduction	3
2. Specifications	5
3. Antenna Characteristics	7
4. 2D Radiation Patterns	11
5. 3D Radiation Patterns	14
6. Mechanical Drawing - Antenna	15
7. Antenna Integration Guide	16
8. Mechanical Drawing – Evaluation Board	23
9. Matching Circuit	24
10. Soldering Conditions	25
11. Packaging	26
Changelog	27

Taoglas makes no warranties based on the accuracy or completeness of the contents of this document and reserves the right to make changes to specifications and product descriptions at any time without notice. Taoglas reserves all rights to this document and the information contained herein. Reproduction, use or disclosure to third parties without express permission is strictly prohibited.



1. Introduction



The GWLA.01 GPS/GALILEO / 2.4GHz embedded loop antenna is a high efficiency, miniature SMD, edge mounted ceramic antenna for GPS/GALILEO and 2.4GHz Wi-Fi, WLAN, ZigBee, Bluetooth, and 802.11 applications. It is particularly useful where PCB space is limited. Customers can use this antenna for GPS/GALILEO and 2.4GHz (Wi-Fi or Bluetooth) modules. Rather than using two separate chip antennas for GPS/GALILEO and 2.4GHz, the GWLA.01 has two separate antenna feeds, one for each, making it the ideal choice for applications where there is limited PCB space. The GWLA.01 uses the main PCB as its ground plane, thereby maintaining good efficiency despite its small size. The GWLA.01 can be tuned for different PCB sizes/environments by simply changing the values of the matching circuit. It is ideally mounted on the center edge of a ground-plane.

At 3.2*1.6*0.5mm, the GWLA.01 is one of the smallest combination embedded antennas available worldwide. This antenna is delivered on tape and reel.

Typical Applications – where both GPS/GALILEO and 2.4GHz are required

- Navigation or Position Tracking Systems
- Handheld Devices
- Tablet PCs
- OBD Devices
- Gateways and Routers
- Mobile Cameras
- UAV Communication Systems

Many module manufacturers specify peak gain limits for any antennas that are to be connected to that module. Those peak gain limits are based on free-space conditions. In practice, the peak gain of an antenna tested in free-space can degrade by at least 1 or 2 dBi when put inside a device. So ideally you should go for a slightly higher peak gain antenna than mentioned on the module specification to compensate for this effect, giving you better performance.

Upon testing of any of our antennas with your device and a selection of appropriate layout, integration technique, or cable, Taoglas can make sure any of our antennas' peak gain will be below the peak gain limits. Taoglas can then issue a specification and/or report for the selected antenna in your device that will clearly show it complying with the peak gain limits, so you can be assured you are meeting regulatory requirements for that module.

For example, a module manufacturer may state that the antenna must have less than 2 dBi peak gain, but you don't need to select an embedded antenna that has a peak gain of less than 2 dBi in free-space. This will give you a less optimized solution. It is better to go for a slightly higher free-space peak gain of 3 dBi or more if available. Once that antenna gets integrated into your device, performance will degrade below this 2 dBi peak gain due to the effects of GND plane, surrounding components, and device housing. If you want to be absolutely sure, contact Taoglas and we will test. Choosing a Taoglas antenna with a higher peak gain than what is specified by the module manufacturer and enlisting our help will ensure you are getting the best performance possible without exceeding the peak gain limits.

This antenna can be mounted with no performance degradation in either orientation as long as the antenna is soldered correctly via Surface mounting. Please see the integration instructions section for further detail regarding the optimum way to integrate this antenna into your device.

For further optimization to customer-specific device environments and for support to integrate and test this antennas performance in your device, contact your regional Taoglas Customer Services Team.

2. Specifications

GNSS Frequency Bands Covered						
GPS	L1	L2	L5	L6		
	■	■	■	■		
GLONASS	G1	G2	G3			
	■	■	■			
Galileo	E1	E5a	E5b	E6		
	■	■	■	■		
BeiDou	B1	B2a	B2b	B3		
	■	■	■	■		
QZSS (Regional)	L1	L2C	L5	L6		
	■	■	■	■		
IRNSS (Regional)	L5					
	■					
SBAS	L1/E1/B1	L5/B2a/E5a	G1	G2	G3	
	■	■	■	■	■	

*SBAS systems: WASS(L1/L5), EGNOS(E1/E5a), SDCM(G1/G2/G3), SNAS(B1/B2a), GAGAN(L1/L5), QZSS(L1/L5), KAZZ(L1/L5).

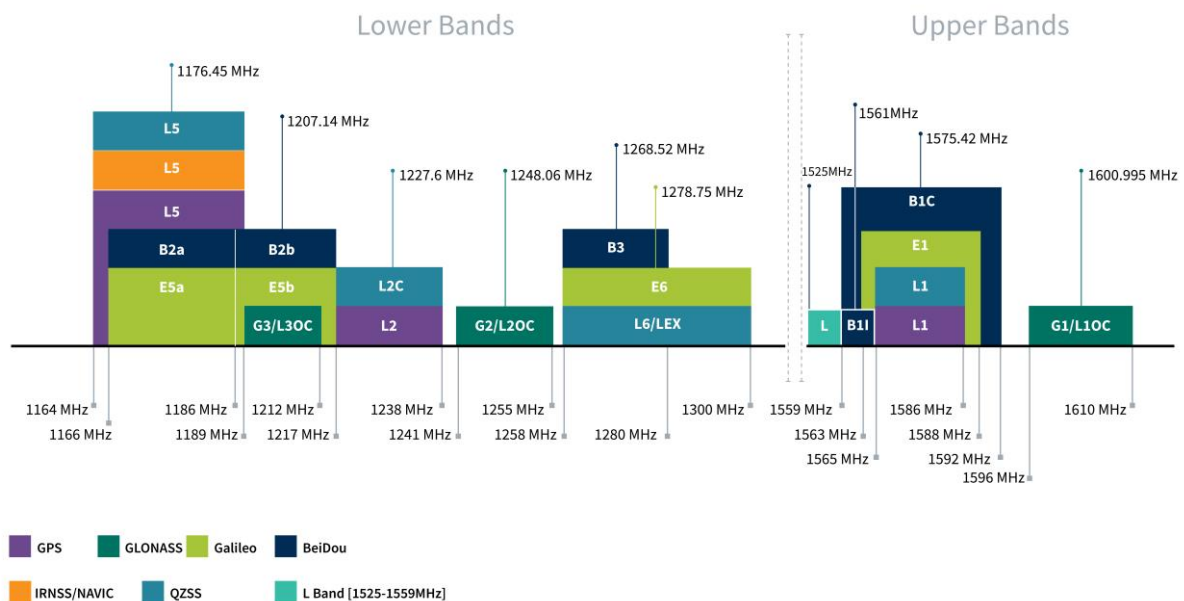

GNSS Bands and Constellations

Electrical*		
Application Bands	GPS/GALILEO Antenna	Wi-Fi/Bluetooth Antenna
Frequency (MHz)	1575.42	2400-2500
Bandwidth (MHz)	32 (RL<-10dB)	100 (RL<-10dB)
Peak Gain (dBi)	1.52	1.43
Efficiency (%)	58.94	67.63
Return Loss (dB)	< -10	< -10
Isolation (dB)	>20	>6
Impedance		50Ω
Polarization		Linear
Input Power		10W
Mechanical		
Dimensions		3.2*1.6*0.5mm
Ground Plane		80*40mm (Standard Evaluation Board)
Weight		0.02g
Environmental		
Operating Temperature		-40°C to 85°C
Storage Temperature		-40°C to 85°C
Relative Humidity		20% to 70%
Moisture Sensitivity Level (MSL)		3 (168 Hours)

*Tested on 80*40mm evaluation board.

3. Antenna Characteristics

3.1 Return Loss - GPS/GALILEO Band

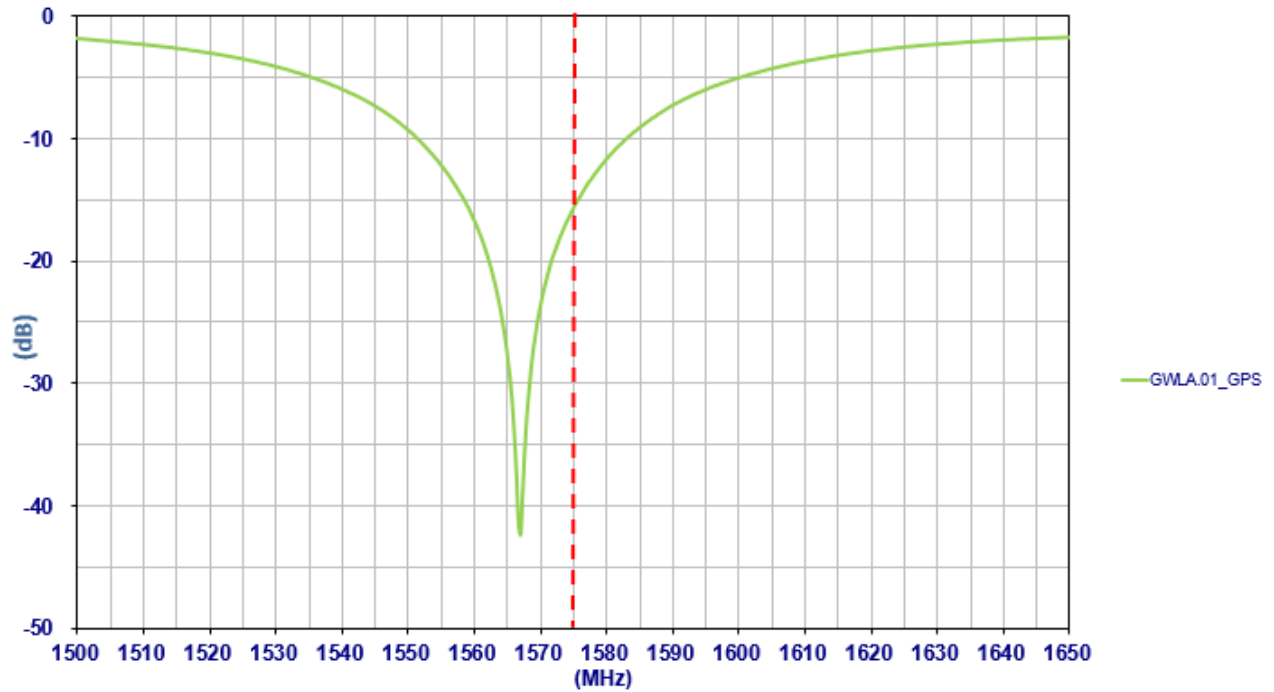

3.2 Efficiency - GPS/GALILEO Band

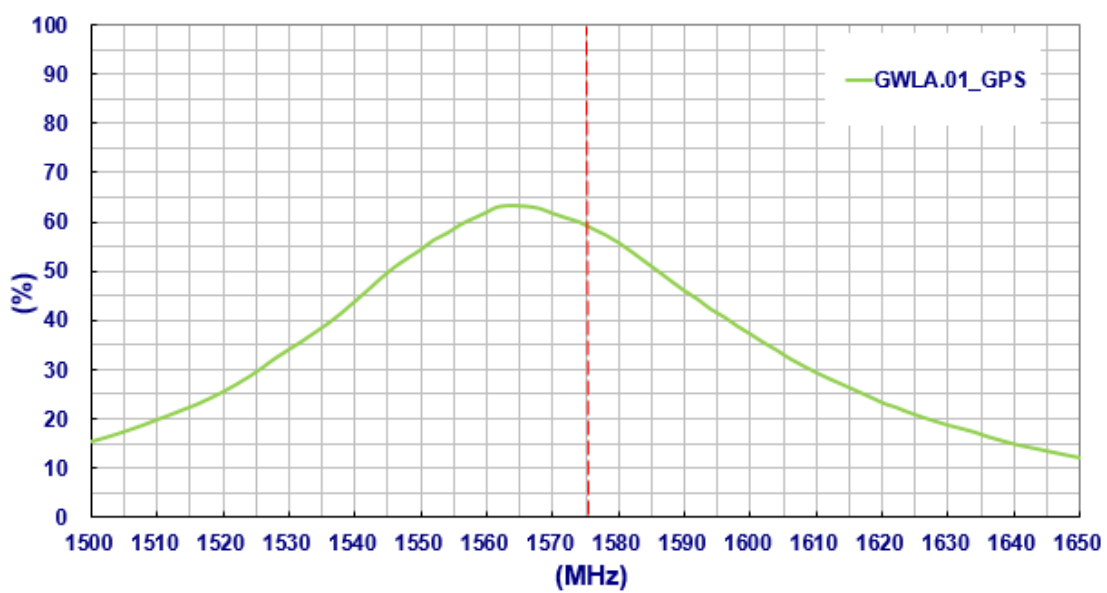

3.3 Peak Gain

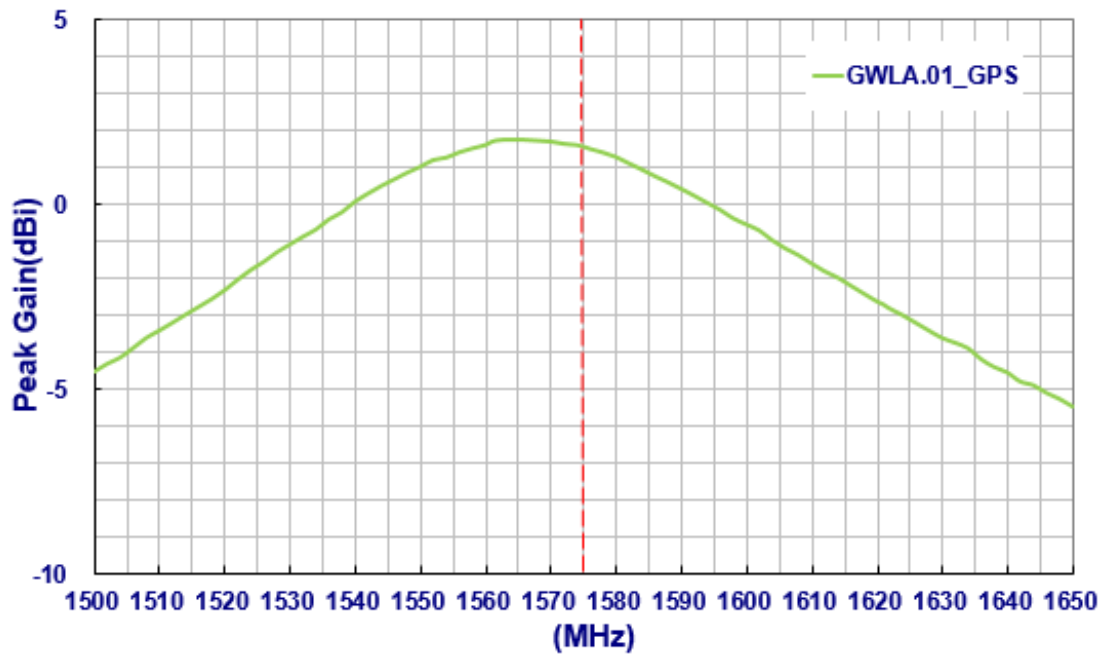

3.4 Return Loss - Wi-Fi

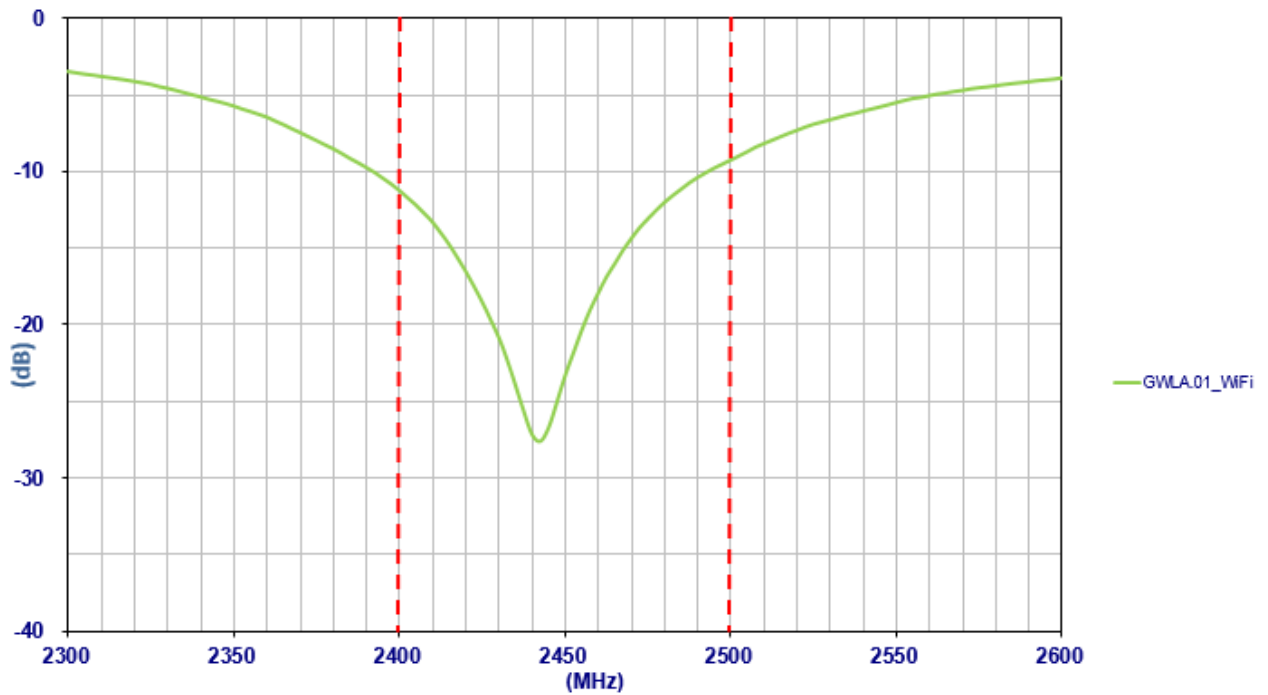

3.5 Efficiency- Wi-Fi Dual-Band

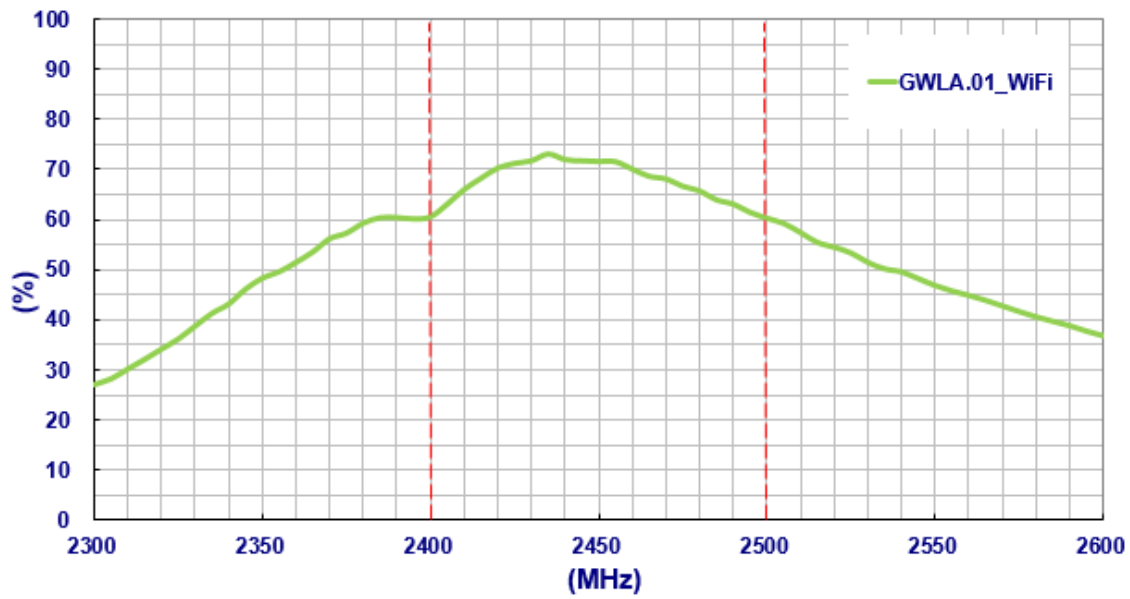

3.6 Peak Gain

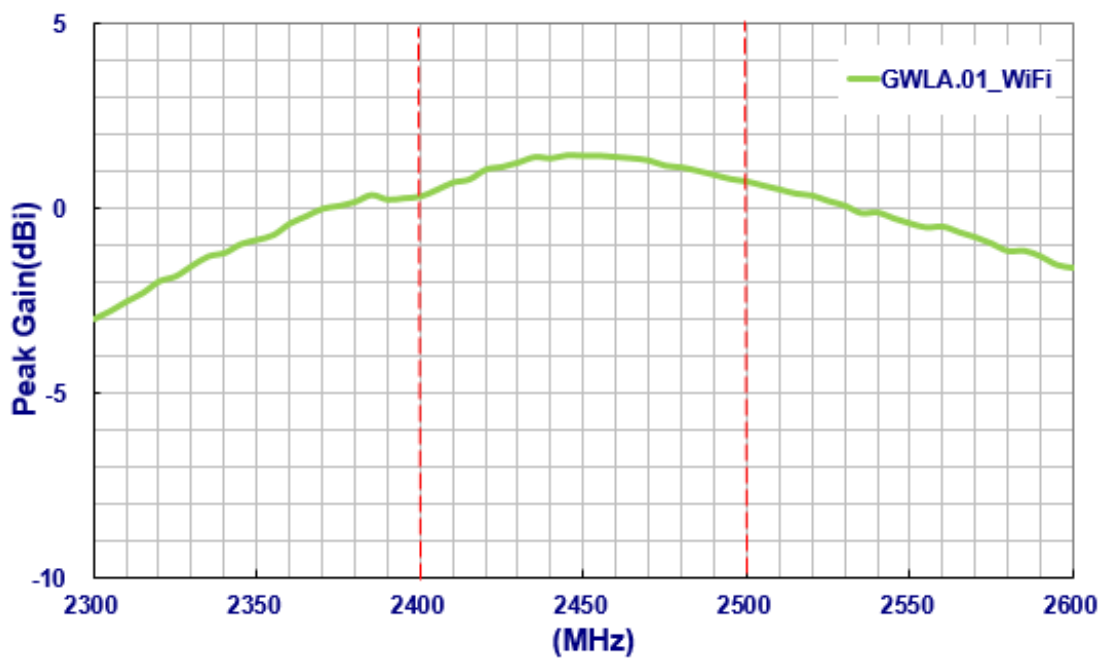

3.7 Isolation between Wi-Fi and GPS/GALILEO Antennas

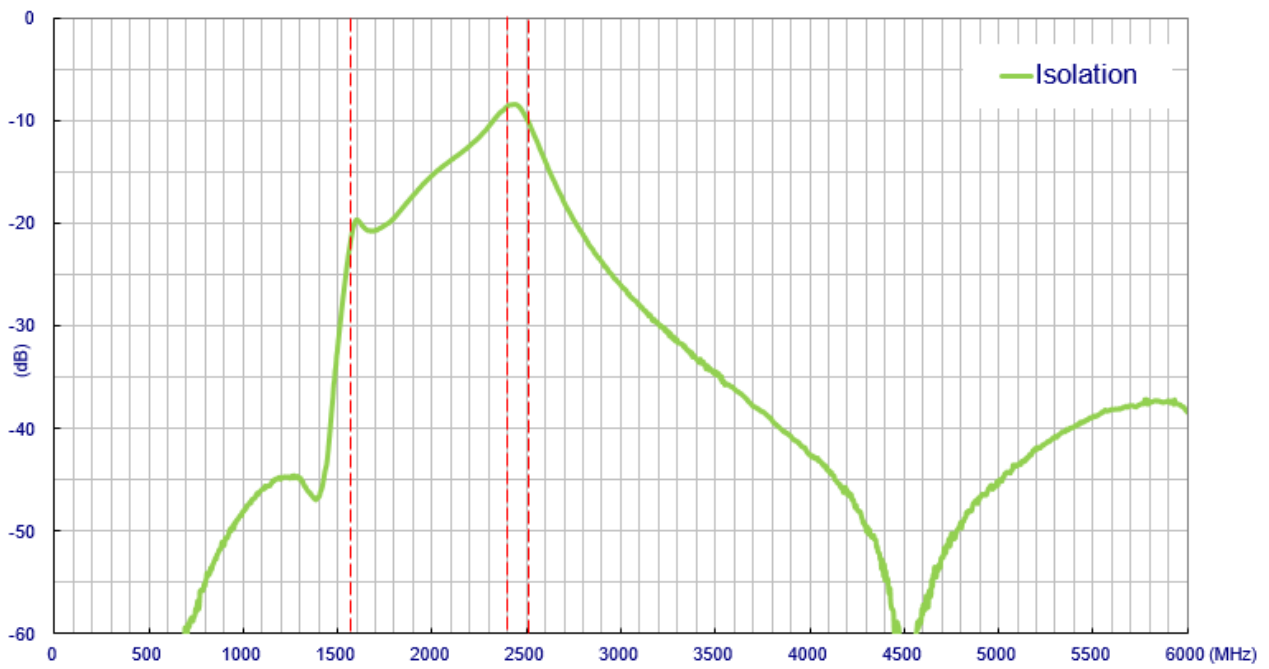

4. 2D Radiation Patterns

4.1 Test Setup

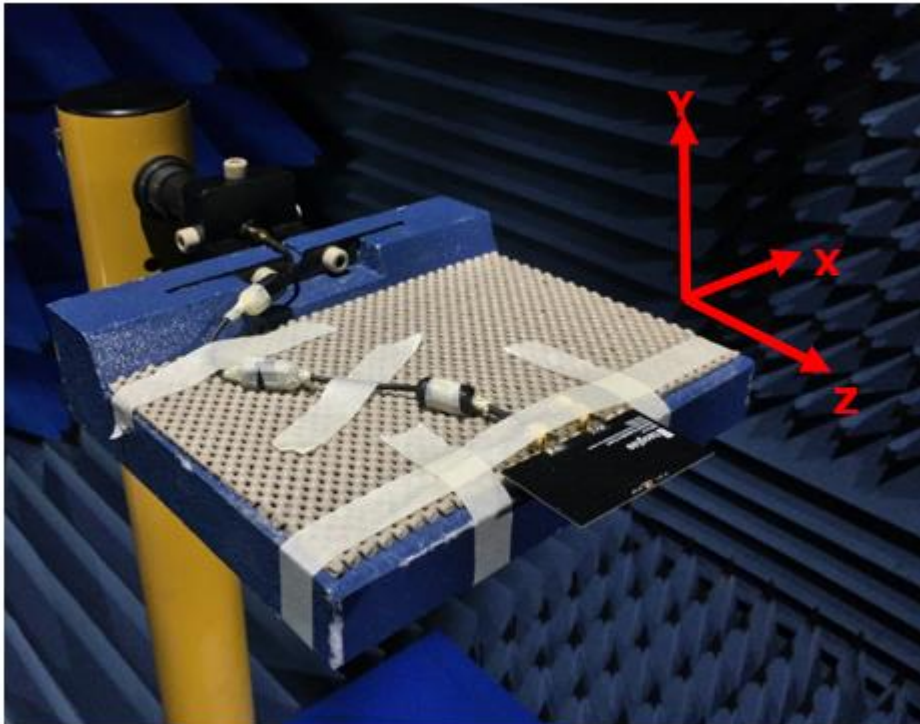

4.2 2D Gain Pattern@ GPS/GALILEO 1575.42MHz

XY Plane

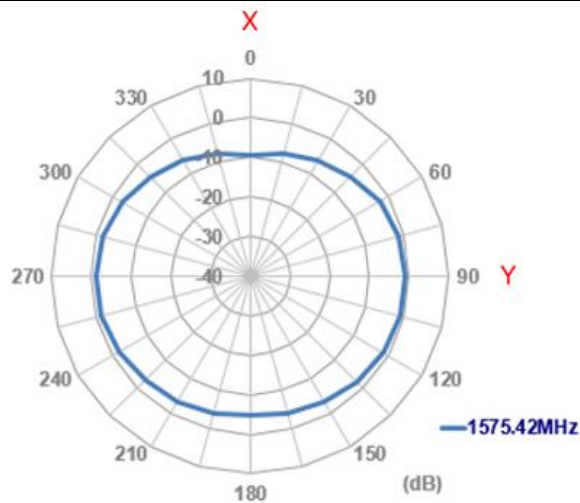

XZ Plane

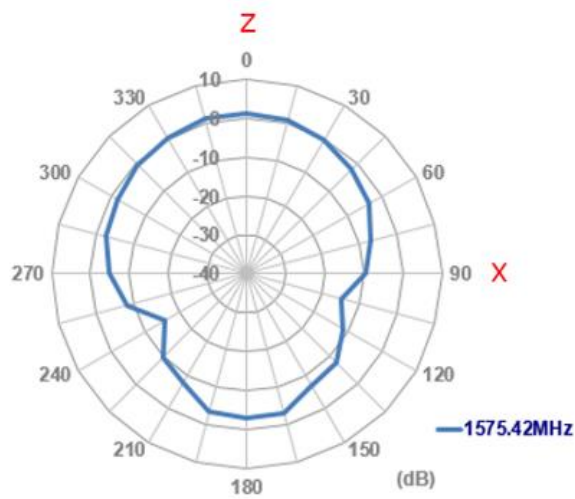

YZ Plane

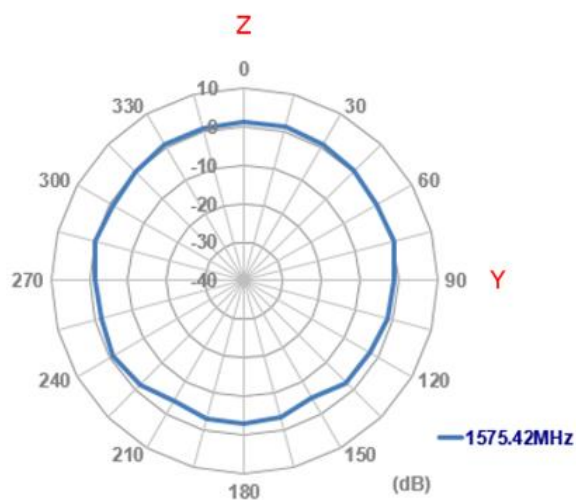

4.3 2D Gain Pattern@ GPS/GALILEO 1575.42MHz

XY Plane

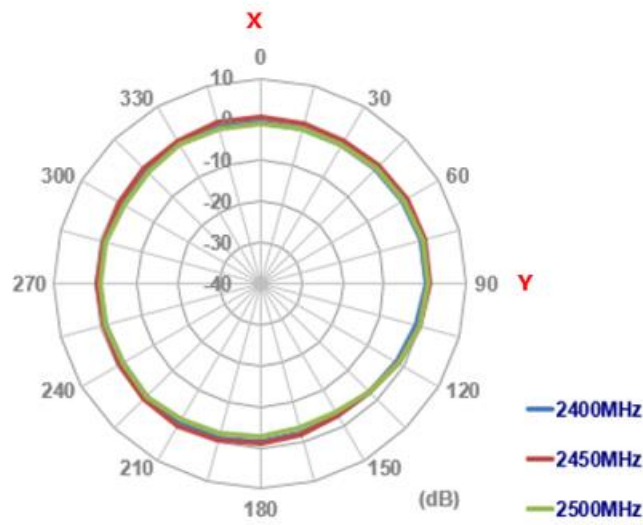

XZ Plane

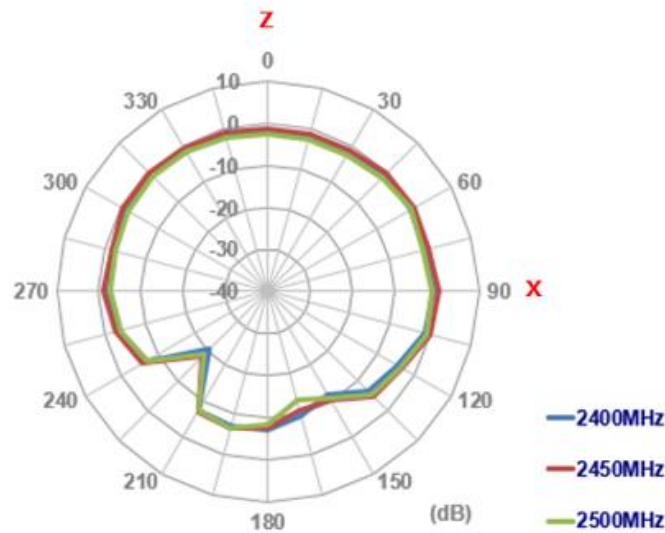

YZ Plane

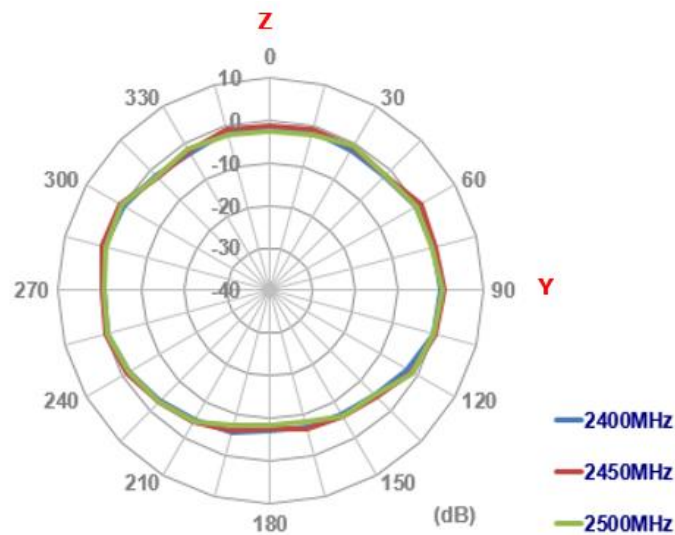

5. 3D Radiation Patterns

5.1 Gain Pattern@ GPS/GALILEO 1575.42MHz

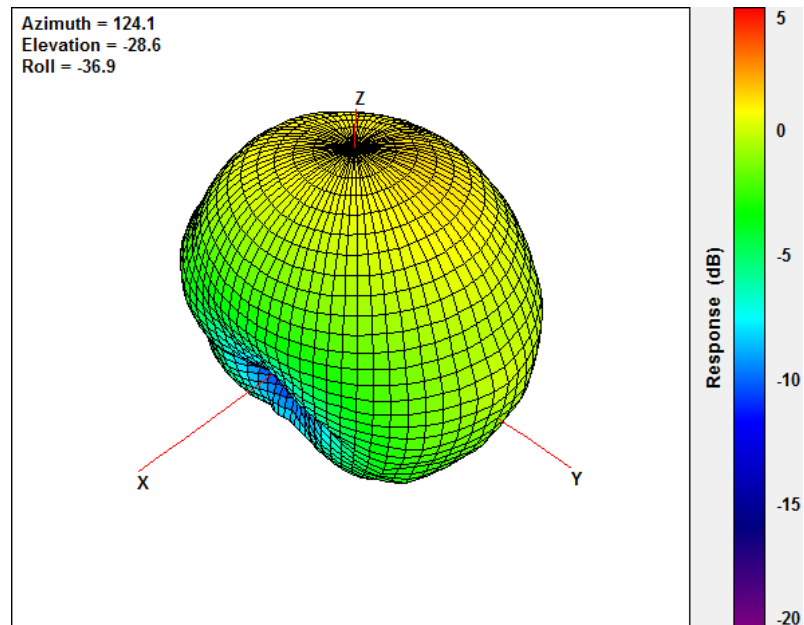

5.2 Gain Pattern@ Wi-Fi Dual Bands

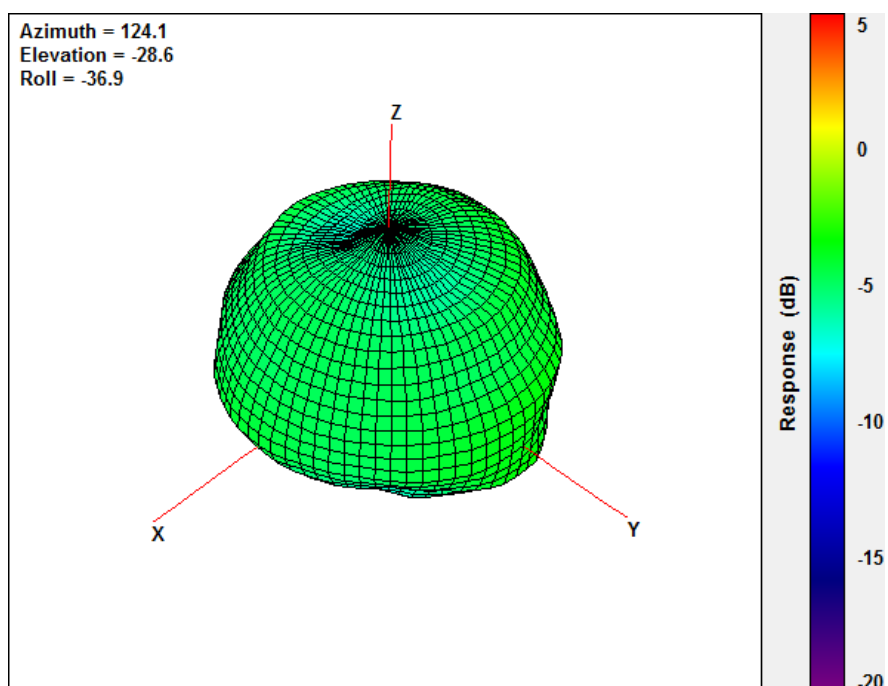

6. Mechanical Drawing (Units: mm)

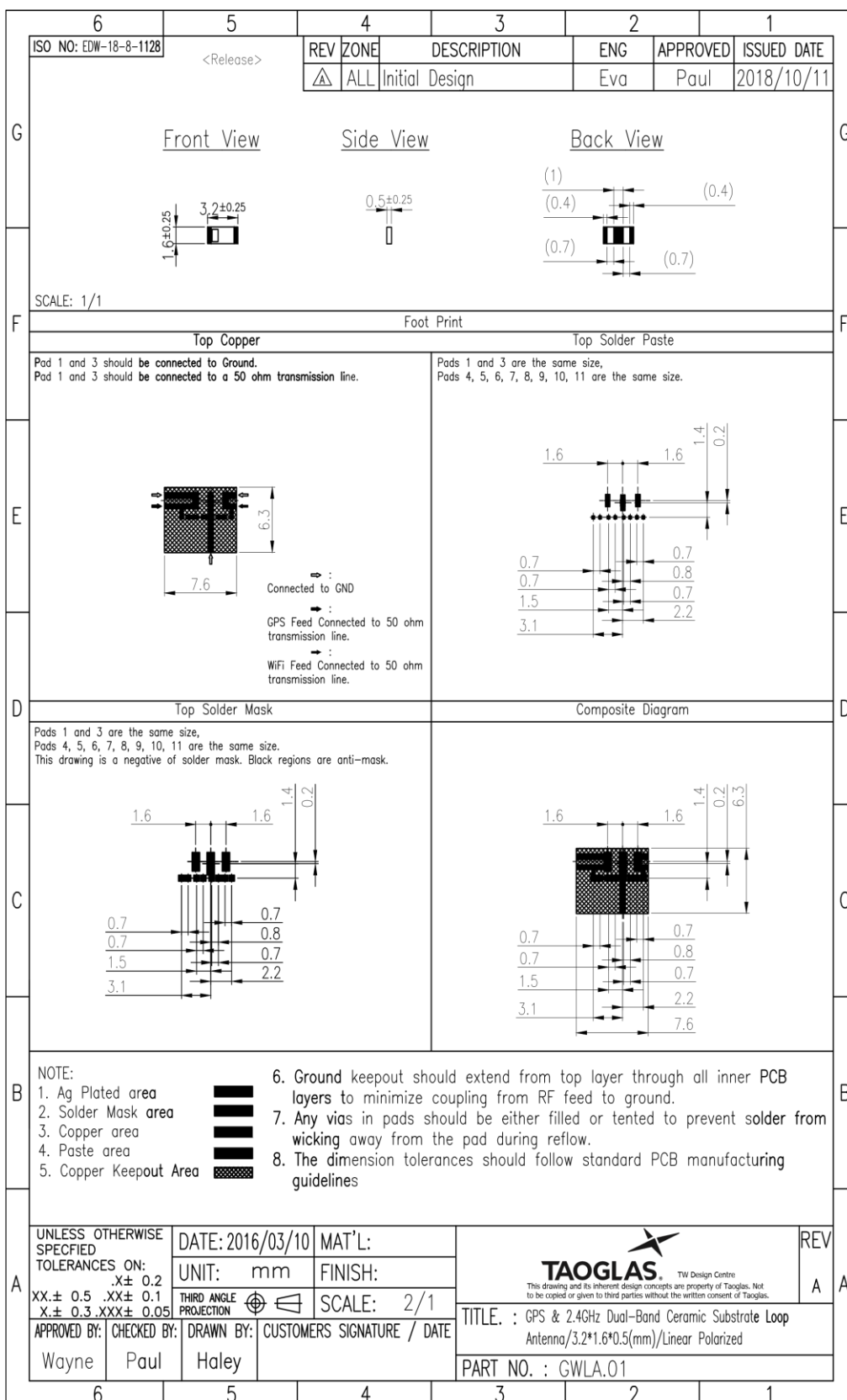

7. Antenna Integration Guide

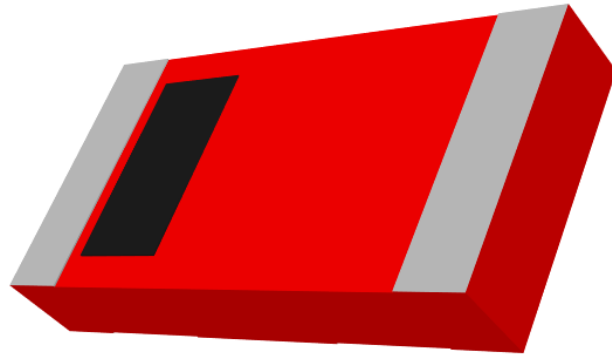

7.1 Schematic Symbol and Pin Definition

The circuit symbol for the antenna is shown below. The antenna has 5 pins with all five pins as functional.

Pin	Description
1	GPS Feed
3	Wi-Fi Feed
2,4,5	Ground

GWLA.01
ANT1

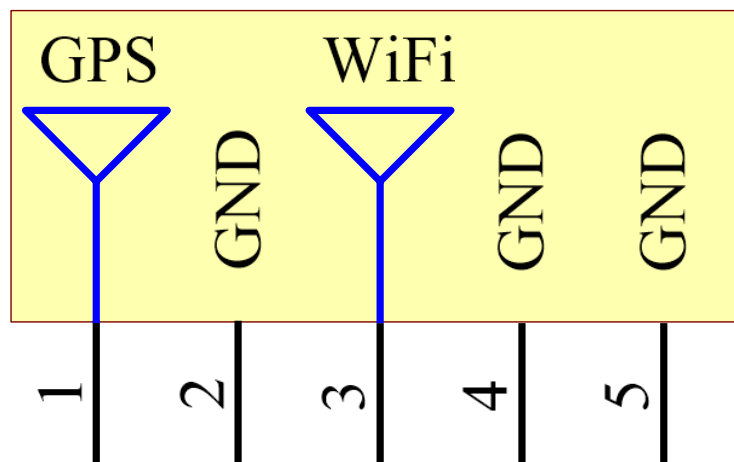

7.2 Antenna Integration

For any given PCB size, the antenna should ideally be placed on the PCB's longest side, to take advantage of the ground plane. Optimized matching components can be placed as shown

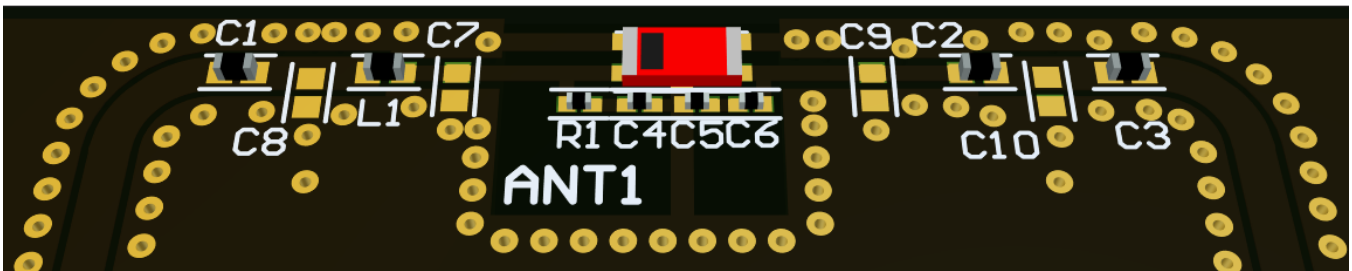

Top Side w/ Solder Mask

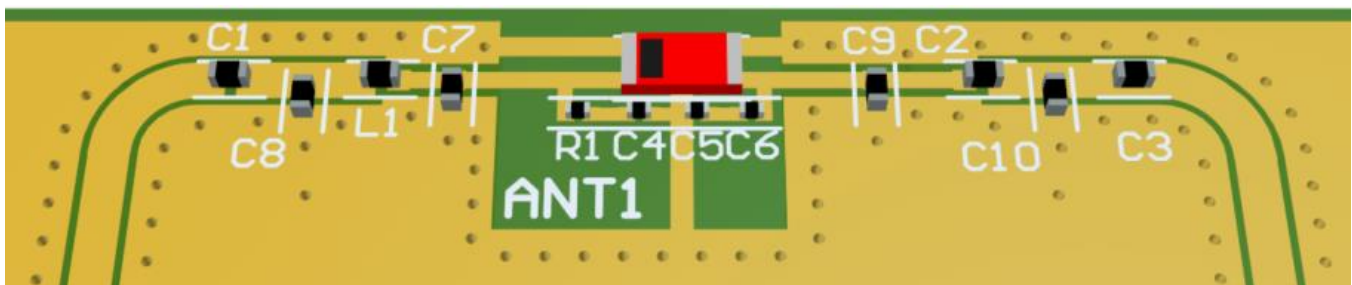

Top Side w/o Solder Mask

7.3 PCB Layout

The footprint and clearance on the PCB must meet the layout drawing in section 6. Note the placement of the optimized components. L1 & R1 are placed as close as possible to the GPS feed (pad 1) but still within the transmission line. C1 & C4 are then placed tightly in series after that with C4 connecting to GND (pad 2). C2 & C6 are placed as close as possible to the Wi-Fi feed (pad 3) but still within the transmission line. C3 & C5 are then placed tightly in series after that with C5 connecting to GND (pad 2). C7, C8, C9 & C10 are optional components but the footprints are recommended in case they are needed.

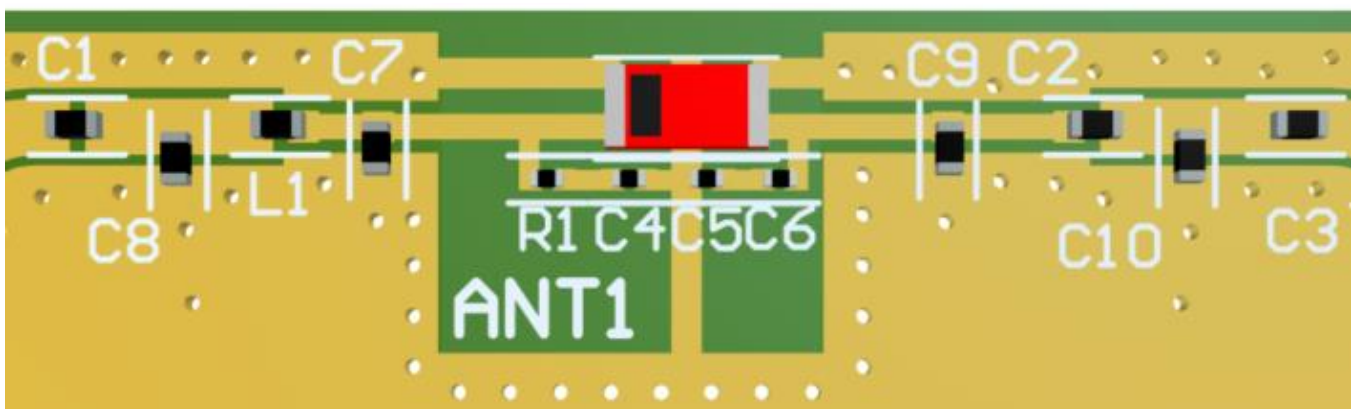

Topside

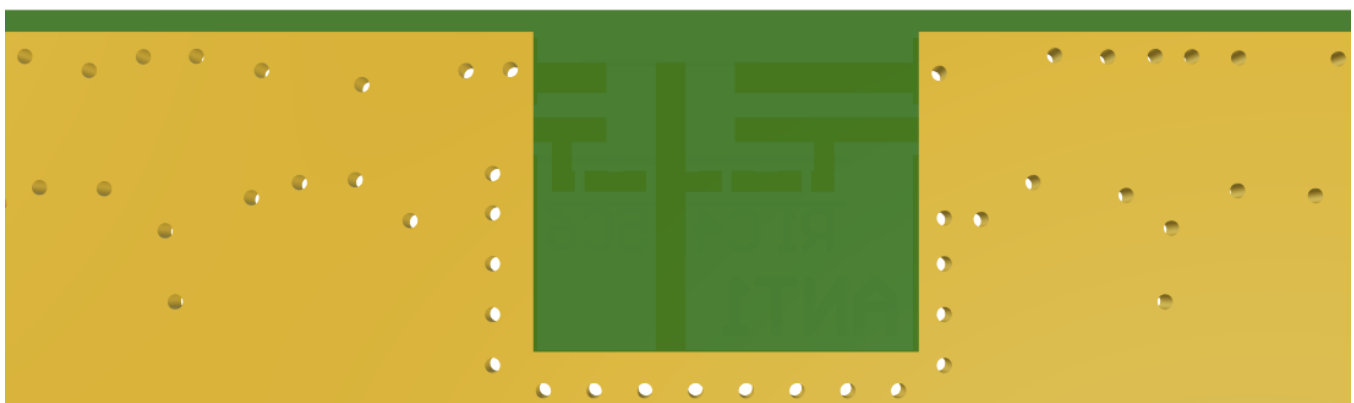

Bottom Side

7.4 PCB Clearance

Below shows the antenna footprint and clearance through ALL layers on the PCB. Only the antenna pads and connections to feed and GND are present within this clearance area (marked RED). The clearance area extends to 6.3mm in length and 7.6mm in width from the top center of the PCB. This clearance area includes the bottom side and ALL internal layers on the PCB.

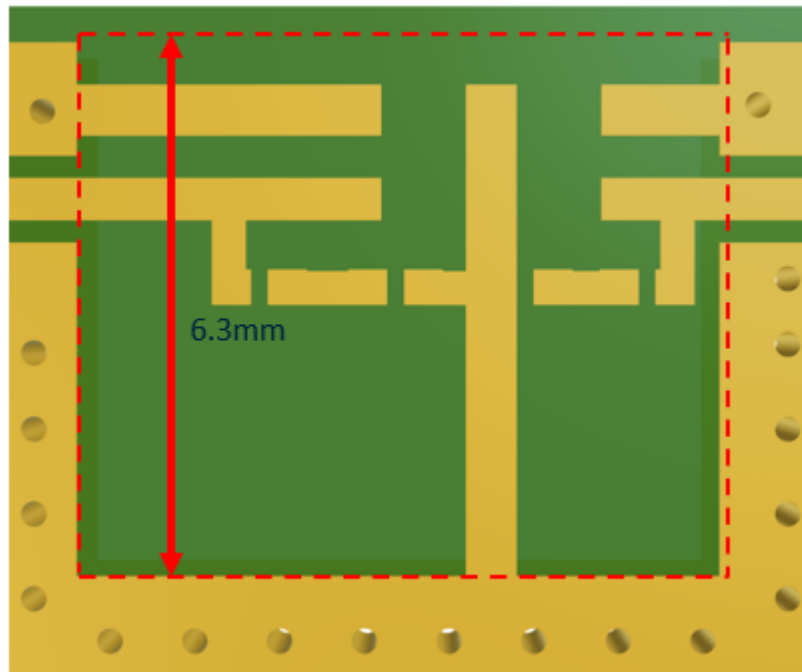

Topside



Bottom Side

7.5 Evaluation Board



Topside



Bottom Side

7.6 Evaluation Board Matching Circuit

A matching component (L1) in series with the GWLA.01 is required for the antenna to have optimal performance on the evaluation board, located outside of the ground plane in the space specified in the above images. Additional matching components may be necessary for your device, so we recommend incorporating extra component footprints, forming a “pi” network, between the cellular module and the edge of the ground plane.

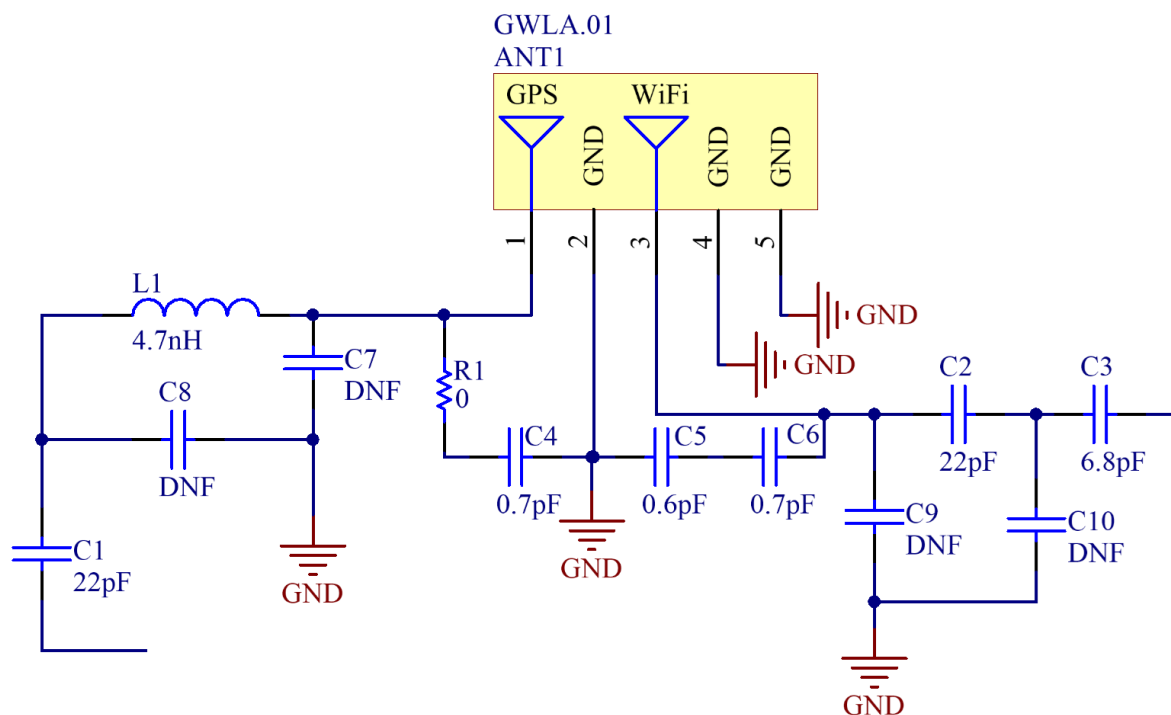

Designator	Type	Value	Manufacturer	Manufacturer Part Number
L1	Inductor	8.7nH	TDK	MLK1005S4N7ST000
R1	Resistor	0 Ohms	Yageo	RC0402JR-070RL
C1	Capacitor	22pF	Murata	GRM1555C1H220JA01D
C2	Capacitor	22pF	Murata	GRM1555C1H220JA01D
C3	Capacitor	6.8pF	Murata	GRM1555C1H6R8CA01D
C4	Capacitor	0.7pF	Murata	GRM0335C1HR70WA01D
C5	Capacitor	0.6pF	Murata	GRM0335C1HR60WA01D
C6	Capacitor	0.7pF	Murata	GRM0335C1HR70WA01D
C7	Capacitor	DNF	-	-
C8	Capacitor	DNF	-	-
C9	Capacitor	DNF	-	-
C10	Capacitor	DNF	-	-

8. Mechanical Drawing – Evaluation Board

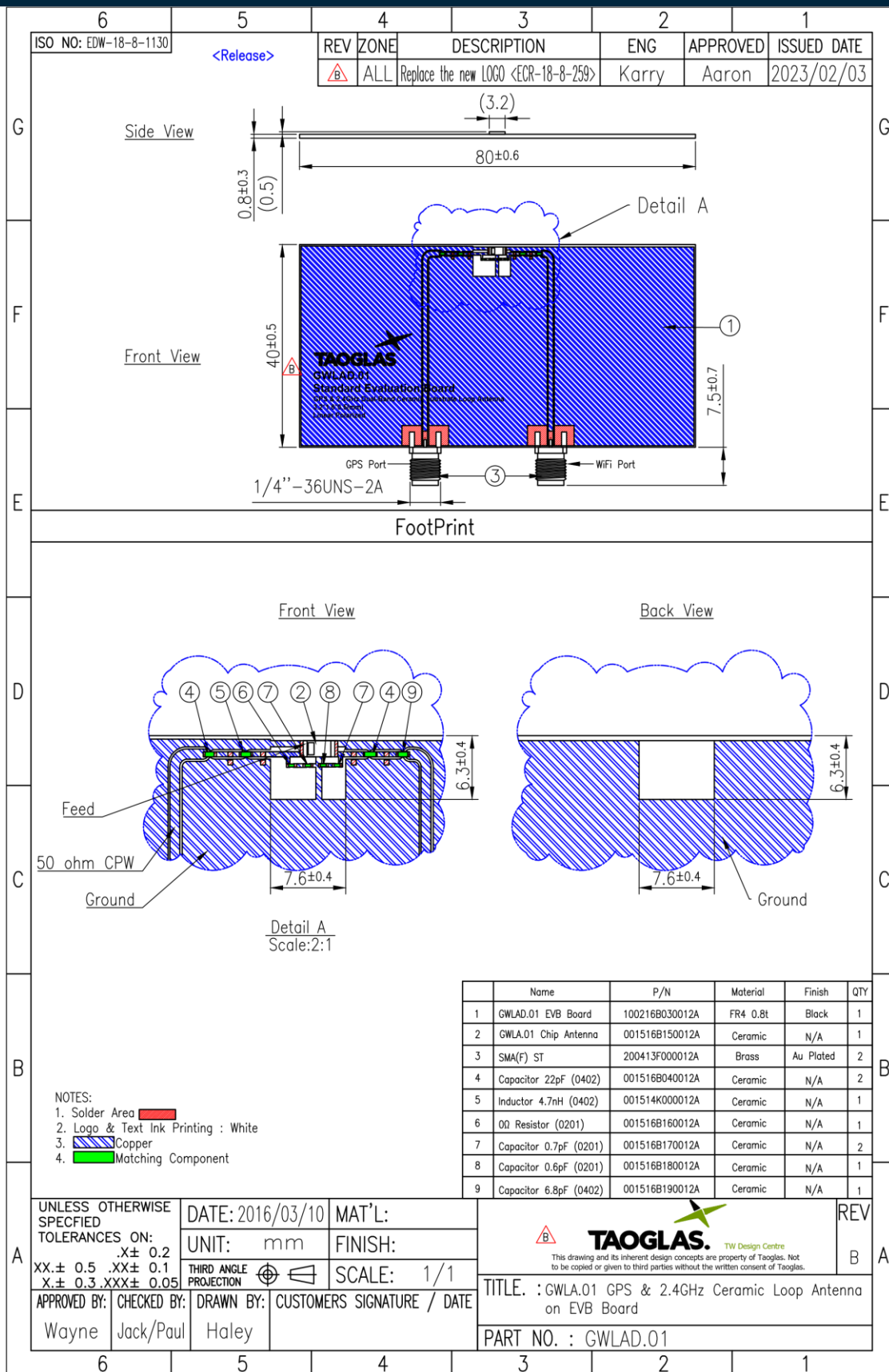

9. Matching Circuit

Like all antennas, surrounding components, enclosures, and changes to the GND plane dimensions can alter performance. A pi-matching network like the one shown below is required in case adjustments need to be made. The antenna EVB has a similar matching network. The components on the EVB are a good starting point for a new design, but will need to be adjusted upon integration for best performance. The zero ohm resistor is needed to solder down a coax pigtail to make measurements with a vector network analyzer.

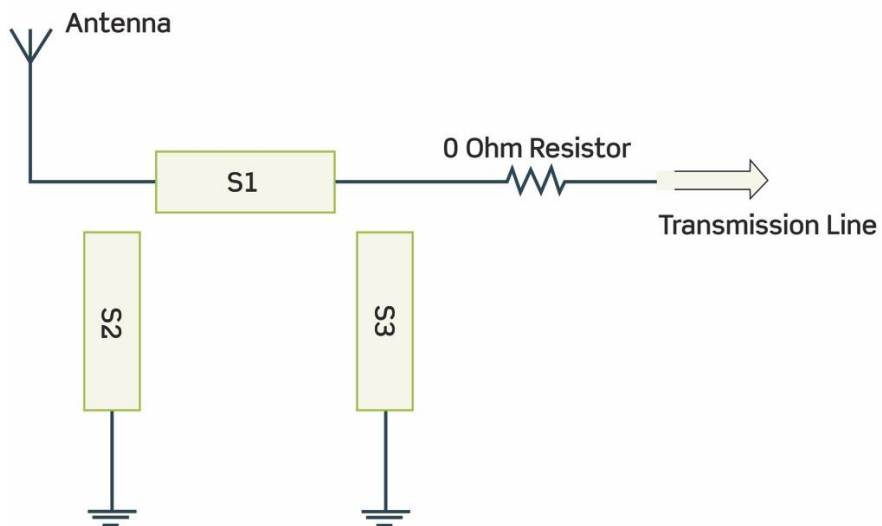

10. Soldering Conditions

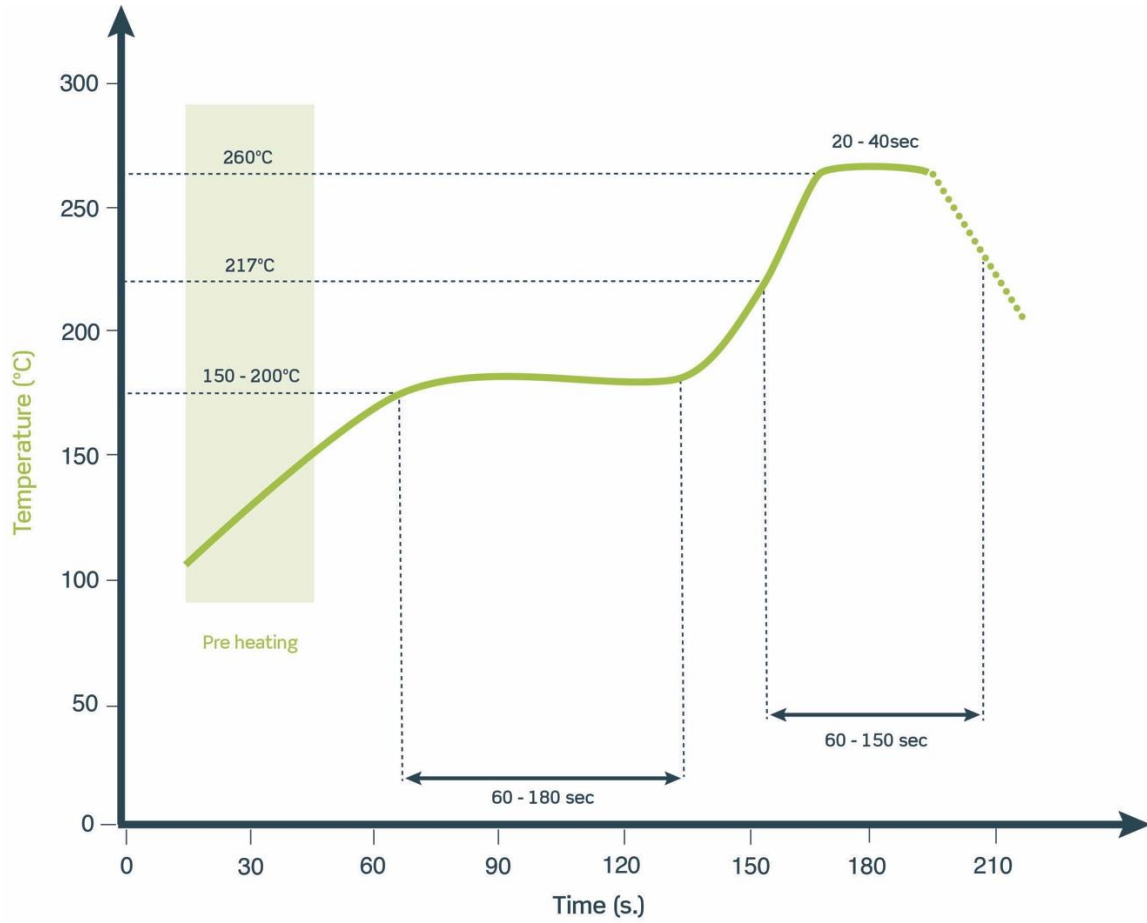

11. Packaging

5000 pcs GWLA.10 per tape & reel
 Dimensions - 330*330*17mm
 Weight - 484g

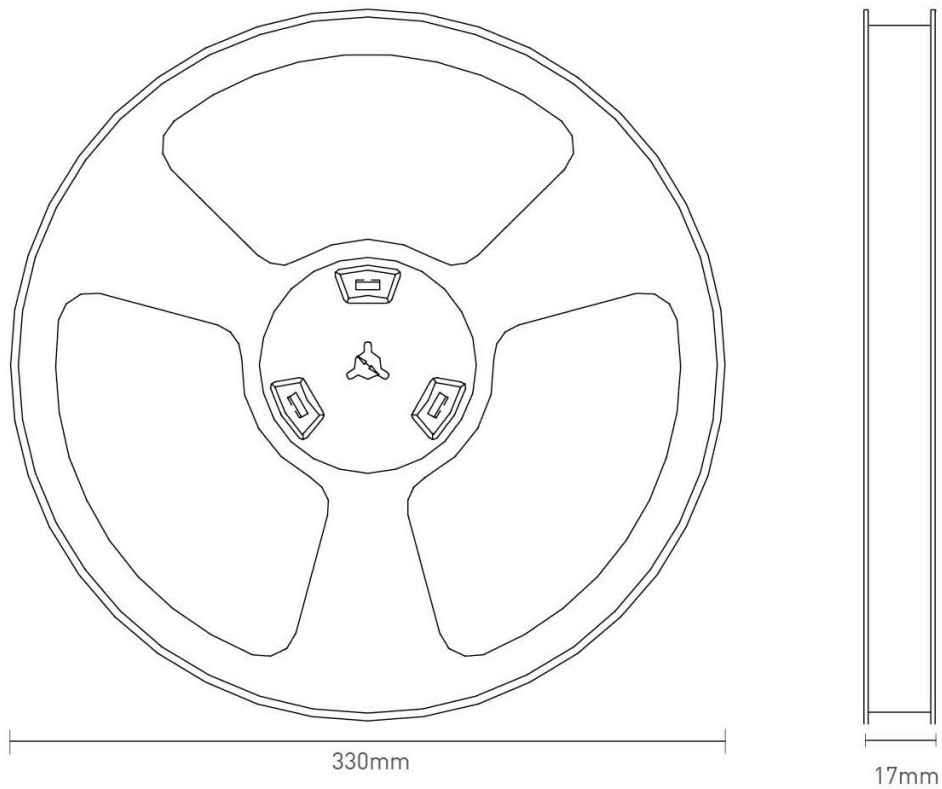

Tape Dimensions (unit: mm)		
Feature	Spec	Tolerances
W	12.00	±0.30
P	4.00	±0.10
E	1.75	±0.10
F	5.50	±0.10
P2	2.00	±0.10
D	1.50	+0.10 -0.00
Po	4.00	±0.10
10Po	40.00	±0.10

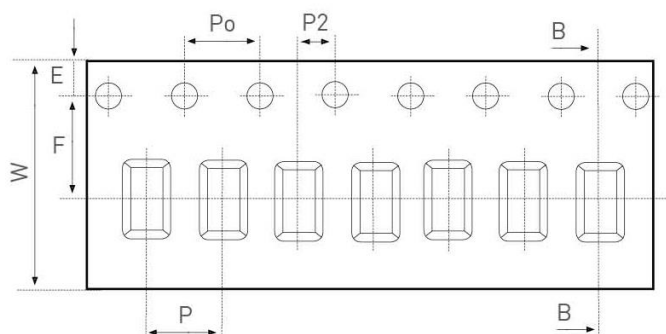

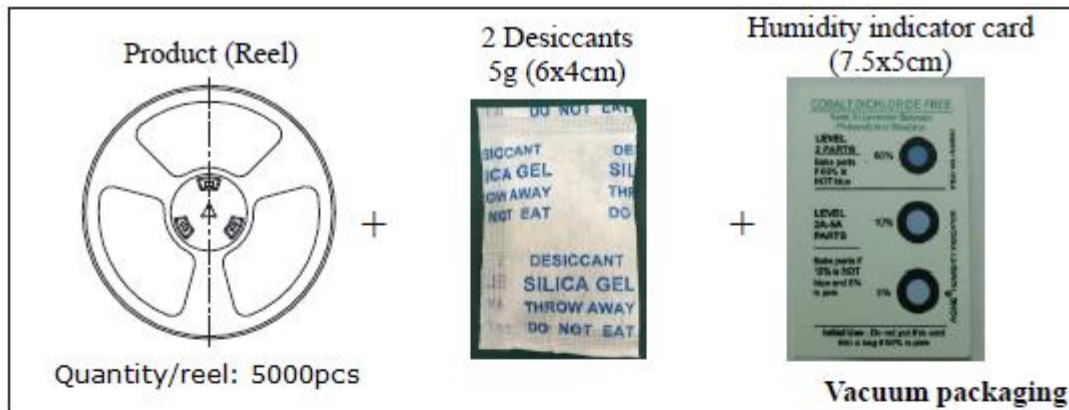

5000 pcs GWLA.01
1 reel in small inner box
Dimensions - 330*330*17
Weight - 484g

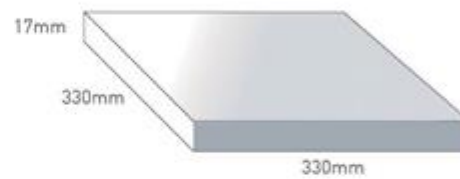

9 boxes / 45000 pcs in one carton
Carton Dimensions - 350*350*210mm
Weight - 4.89Kg

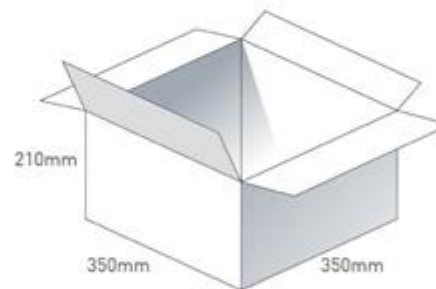

Pallet Dimensions 1220*1020*1410mm
36 Cartons per Pallet
4 Cartons per layer
9 Layers

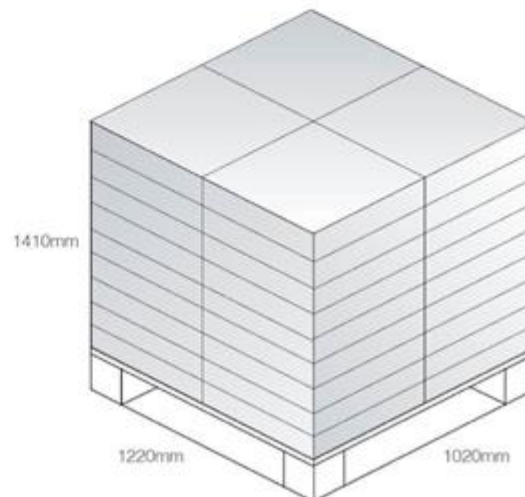

Changelog for the datasheet

SPE-16-8-048– GWLA.01

Revision: C (Current Version)	
Date:	2023-03-10
Changes:	Added Antenna Integration Guide
Changes Made by:	Cesar Sousa

Previous Revisions

Revision: B	
Date:	2022-06-20
Changes:	Updated Specifications
Changes Made by:	Cesar Sousa

Revision: A (Original First Release)	
Date:	2017-05-17
Notes:	Initial Specification Release
Author:	Author



TAOGLAS®

www.taoglas.com

