



# TAOGLAS®



## Datasheet

### 2.4GHz 2dBi Terminal Mount Dipole Antenna

**Part No:** GW.15.2113

**Description:**

2dBi 2.4GHz Dipole Antenna, Hinged SMA(M)

**Features:**

SMA Male Straight Connector

Peak Gain 2dBi

High Efficiency up to 85%

Works well with or without ground plane

Hinged Design for Straight or 90° Degree Mounting

Robust TPU Housing

Dimensions: 108.5 x 10mm

RoHS & REACH Compliant

1. Introduction	3
2. Specifications	4
3. Antenna Characteristics	5
4. Radiation Patterns	9
5. Ground Plane Effect	11
6. Radiation Patterns 2.4GHz to 2.5GHz	23
7. 3D Radiation Patterns	41
8. Mechanical Drawing	47
9. Packaging	48
<hr/>	
Changelog	49

Taoglas makes no warranties based on the accuracy or completeness of the contents of this document and reserves the right to make changes to specifications and product descriptions at any time without notice. Taoglas reserves all rights to this document and the information contained herein. Reproduction, use or disclosure to third parties without express permission is strictly prohibited.



## 1. Introduction



The GW.15 2.4GHz dipole SMA terminal mount antenna is ideal for 2.4GHz wireless applications such as Bluetooth and Wireless LAN. At only 108mm in length, an omni-directional 2dBi gain across all bands ensures constant reception and transmission. The antenna structure is designed for robust handling and the housing is made with robust TPU giving superior environmental reliability and a quality finish. The antenna can be rotated 90 degrees on the base hinge for ease of placement.

Many module manufacturers specify peak gain requirements for any antennas that is to be connected to that module. Upon testing of any of our antennas with your device and a selection of appropriate layout, integration technique, or cable, Taoglas can make sure any of our antennas peak gain will be below the peak gain requirements. Taoglas can then issue a specification and/or report for these selected Wi-Fi antennas in your device that will clearly show it complying with the peak gain requirements, so you can be assured you are meeting regulatory requirements for that module. It is better not to select an embedded antenna with very low free-space peak gain (<2dBi) directly, as this antenna would have worse performance in your device, and lead to compromised performance compared to using a Taoglas antenna. For more information, contact your regional sales office.

The connector can be customized subject to MOQ, please contact your regional Taoglas customer support team for further information.

## 2. Specifications

ELECTRICAL	
Frequency	2.4~2.5 GHz
Peak Gain*	2 dBi
VSWR	≤ 1.8
Return Loss**	≥12dB
Polarization	Vertical
Impedance	50 Ω
Radiation Pattern	Omni-directional
Power Handling	10W
MECHANICAL	
Antenna Length	108.5 mm (Straight) / 87.5mm (Hinged)
Antenna Weight	9g
Antenna Cover	TPU Black
Connector	SMA (M)
Antenna Base	Nylon
ENVIRONMENTAL	
Operating Temperature	-40°C to +85°C
Storage Temperature	-40°C to +90°C

\*Tested on a 500mm x 500mm Ground Plane

\*\*Tested on a 150mm x 90mm Ground Plane

## 3. Antenna Characteristics

### 3.1 Test Setup

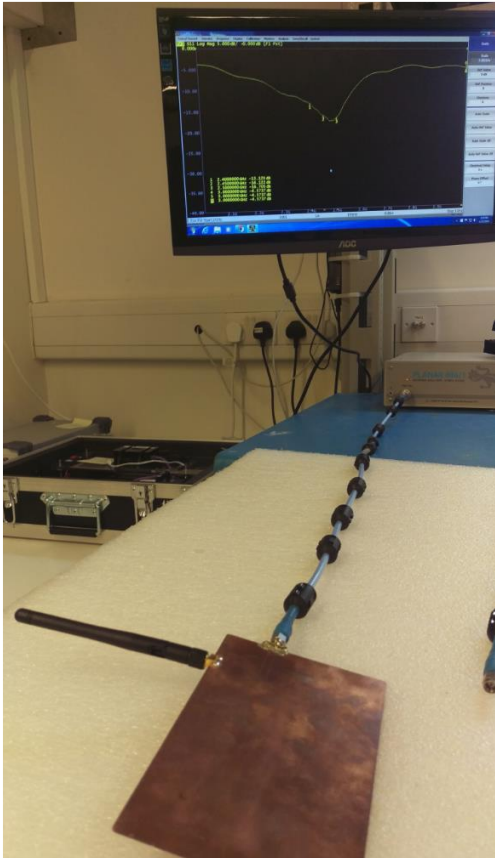

Return Loss Measurement

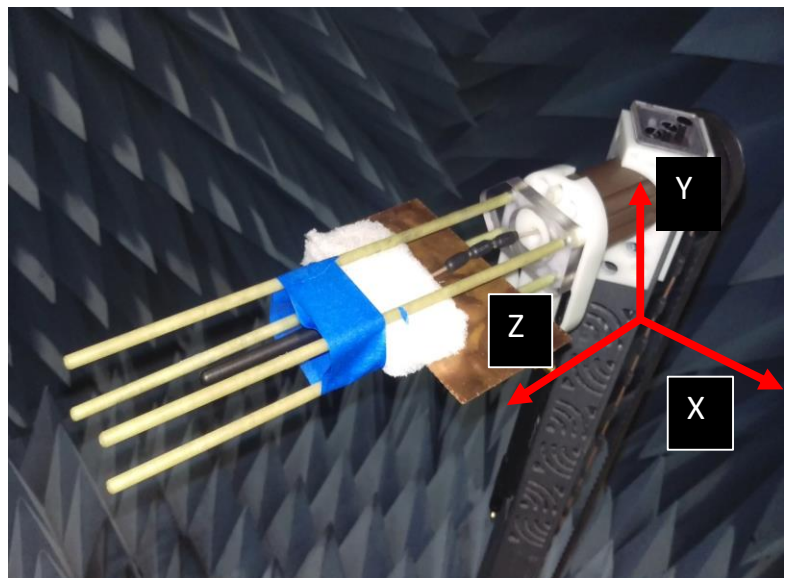

Chamber Setup

### 3.2 Return Loss

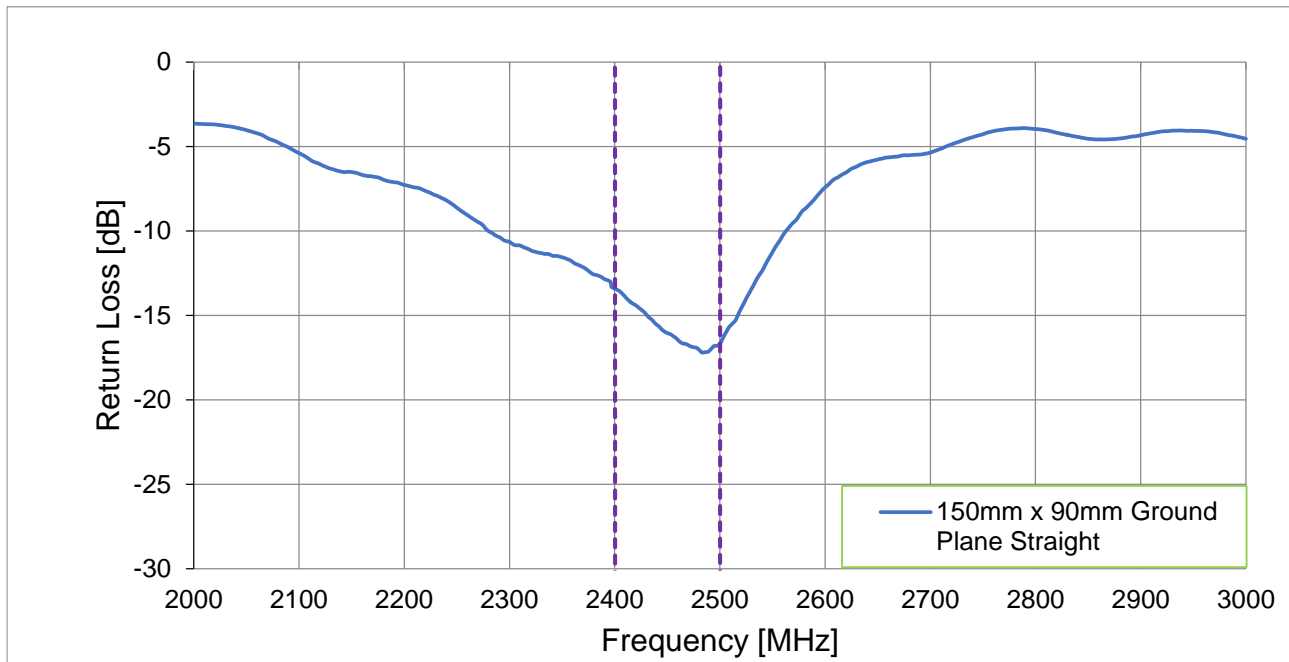

### 3.3 VSWR

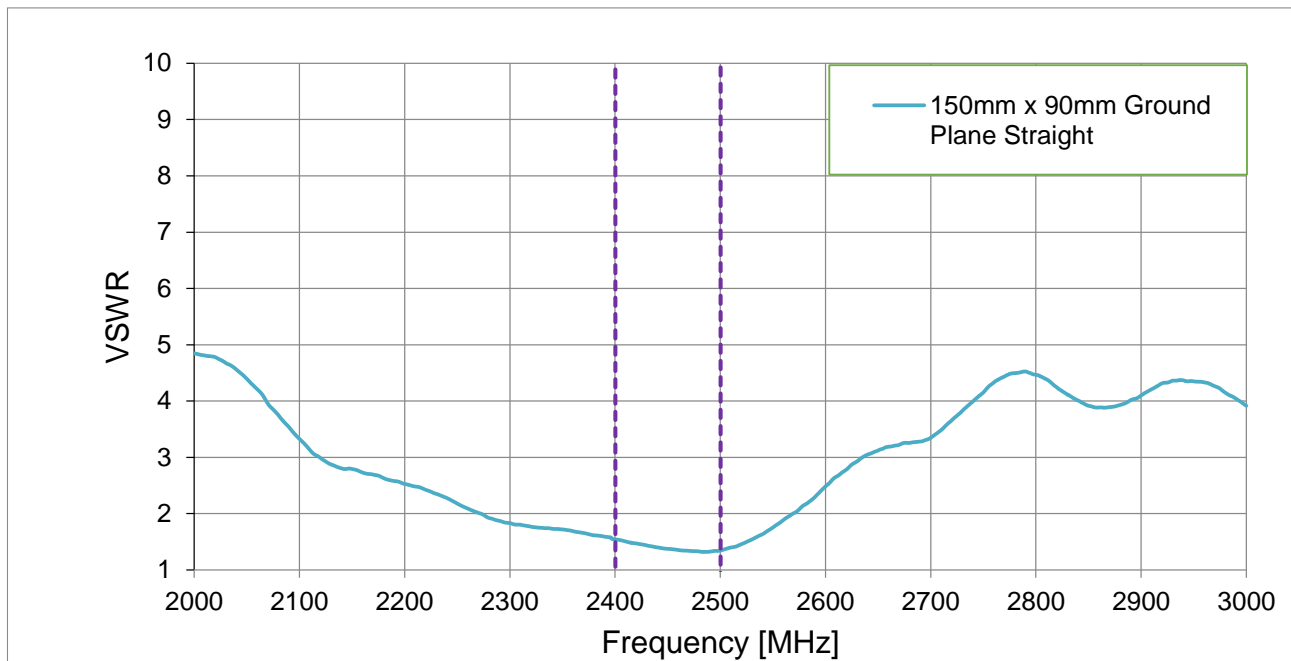

### 3.4 Efficiency

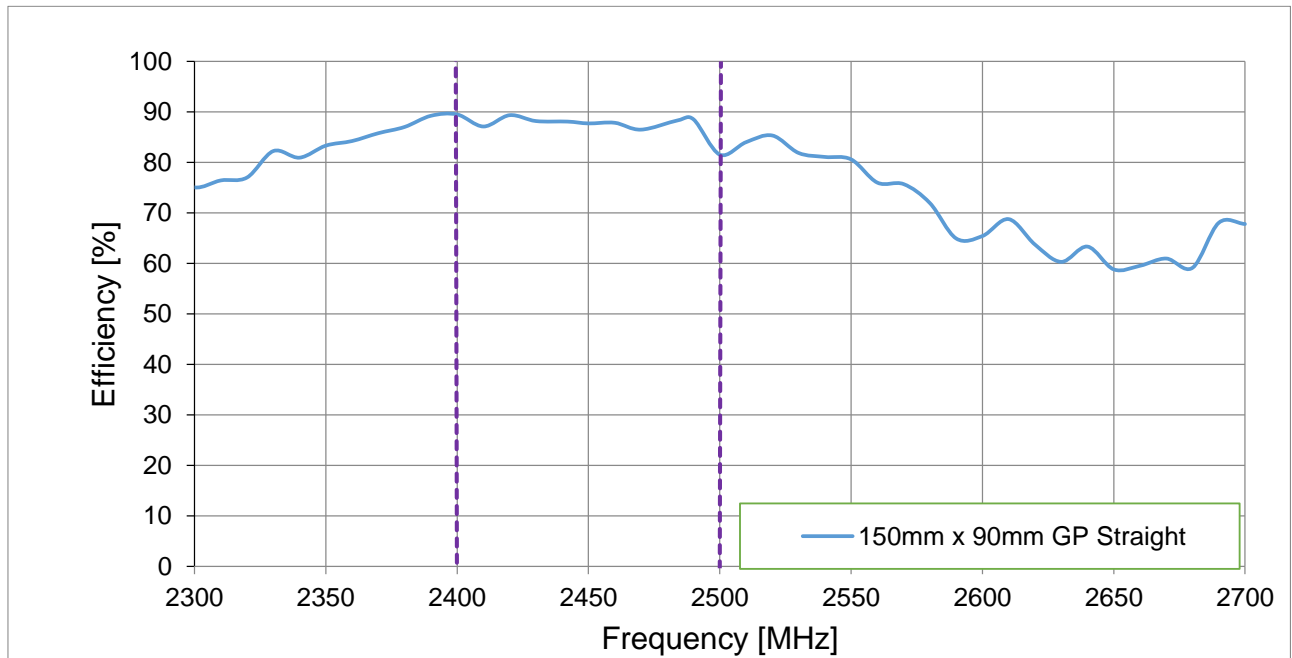

### 3.5 Peak Gain

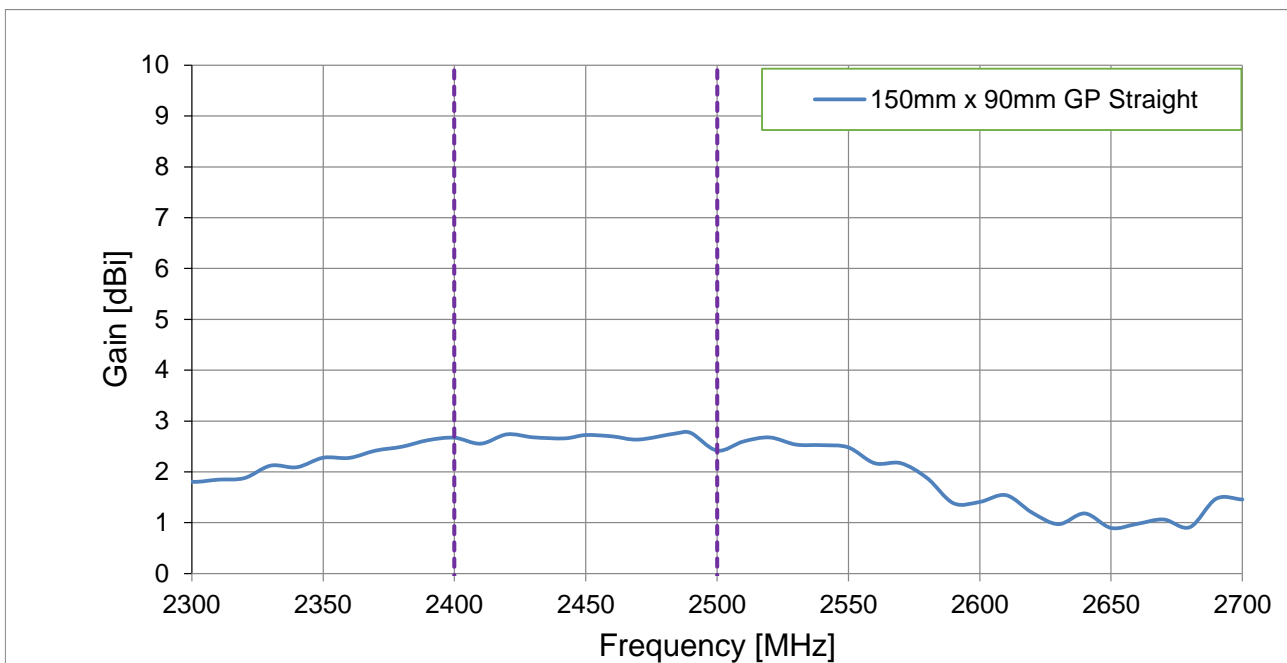

3.6 Average Gain

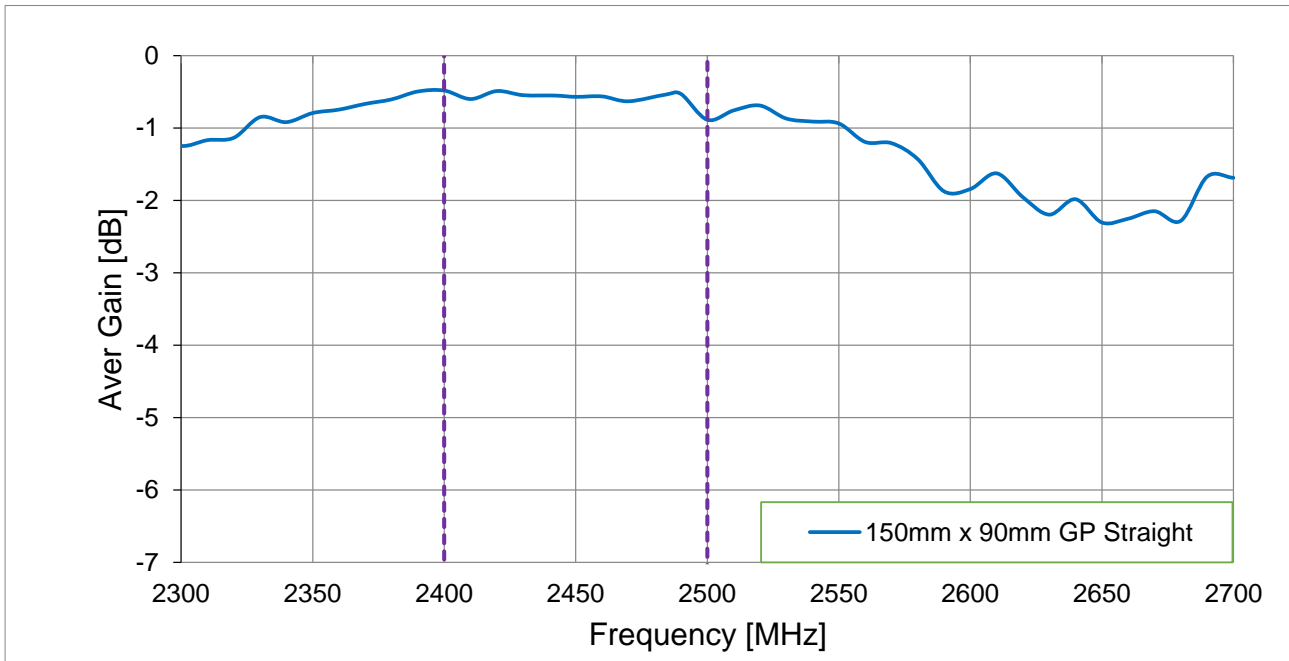



## 4. Radiation Patterns

### 4.1 Straight Position XY Plane

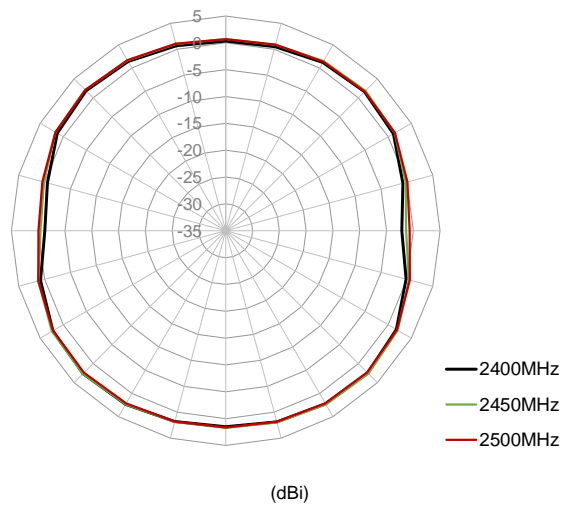

### 4.2 Straight Position ZX Plane

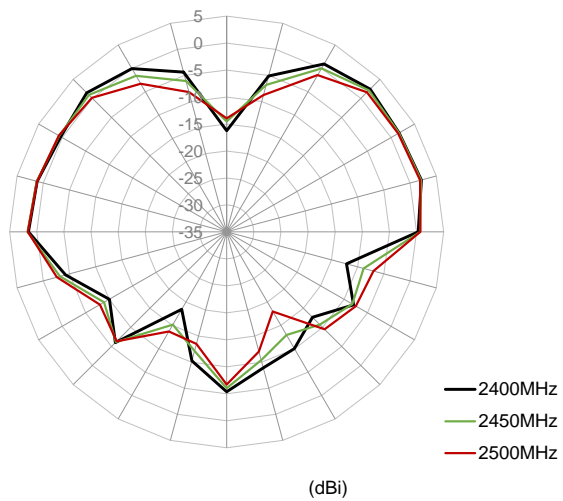

### 4.3 Straight Position YZ Plane

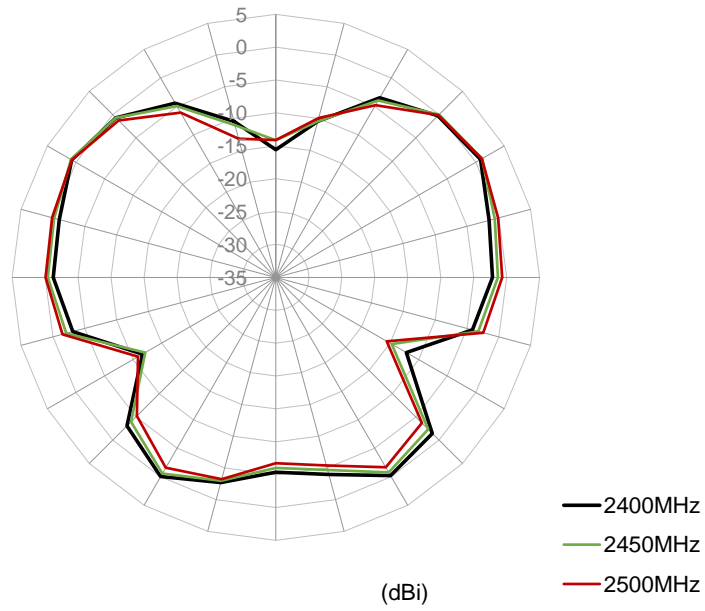

## 5. Ground Plane Effect

Six ground setups are used to see the effect of positioning the GW.15 close to a ground plane.

1. Extra Small Ground (30mm x 30mm) – common size of Bluetooth devices
2. Small Ground (15 x 9cm) – common size of IoT devices. GW.15 is mounted at the longer edge for testing.
3. Ground Edge (30cm x 30cm) – simulate the effect of mounting antenna on a gateway/router.
4. Ground Centre (30cm x 30cm) – simulate the effect of mounting antenna in the centre of a big ground plane.
5. Large Ground Edge (50cm x 50cm) - simulate the effect of mounting antenna on a large gateway/router.
6. Large Ground Center (50cm x 50cm) - simulate the effect of mounting antenna in the centre of a large ground plane e.g. vehicle body.

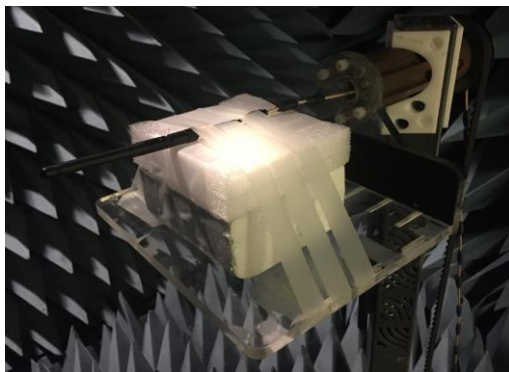

Free Space

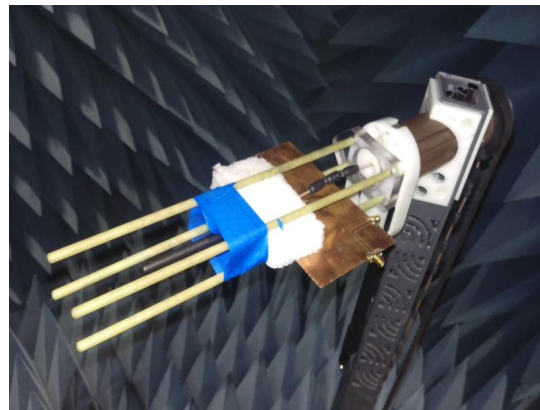

15cm x 9cm Ground Plane Edge

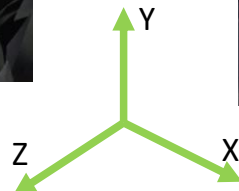

30mm x 30mm Ground Plane Edge

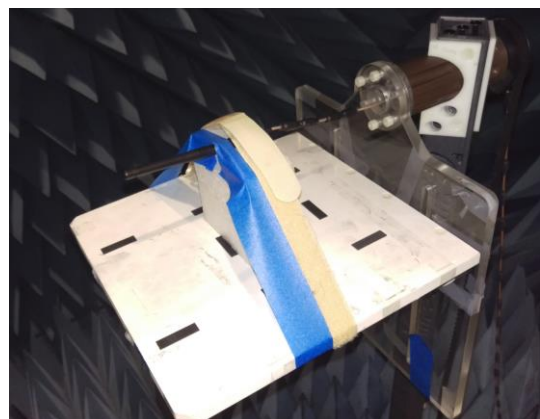

30mm x 30mm Ground Plane Center

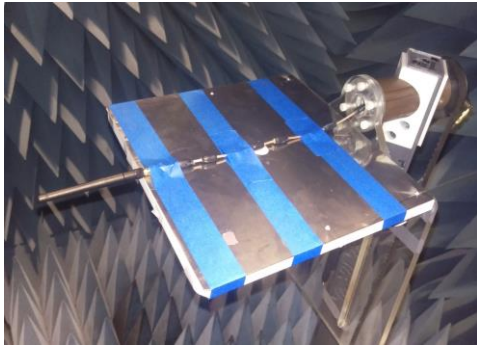

30cm x 30cm Ground Plane Edge

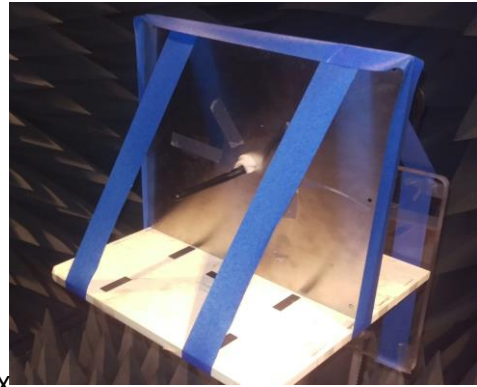

30cm x 30cm Ground Plane Center

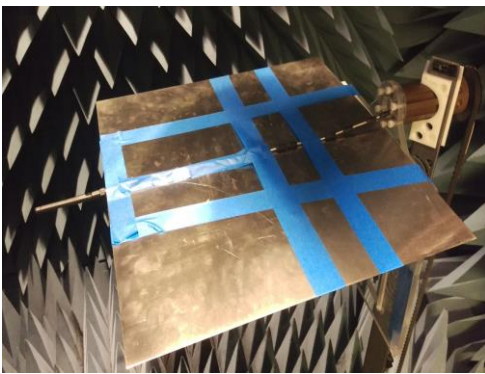
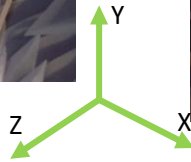

50cm x 50cm Ground Plane Edge



50cm x 50cm Ground Plane Center

## 5.1 Return Loss (Straight Antenna)

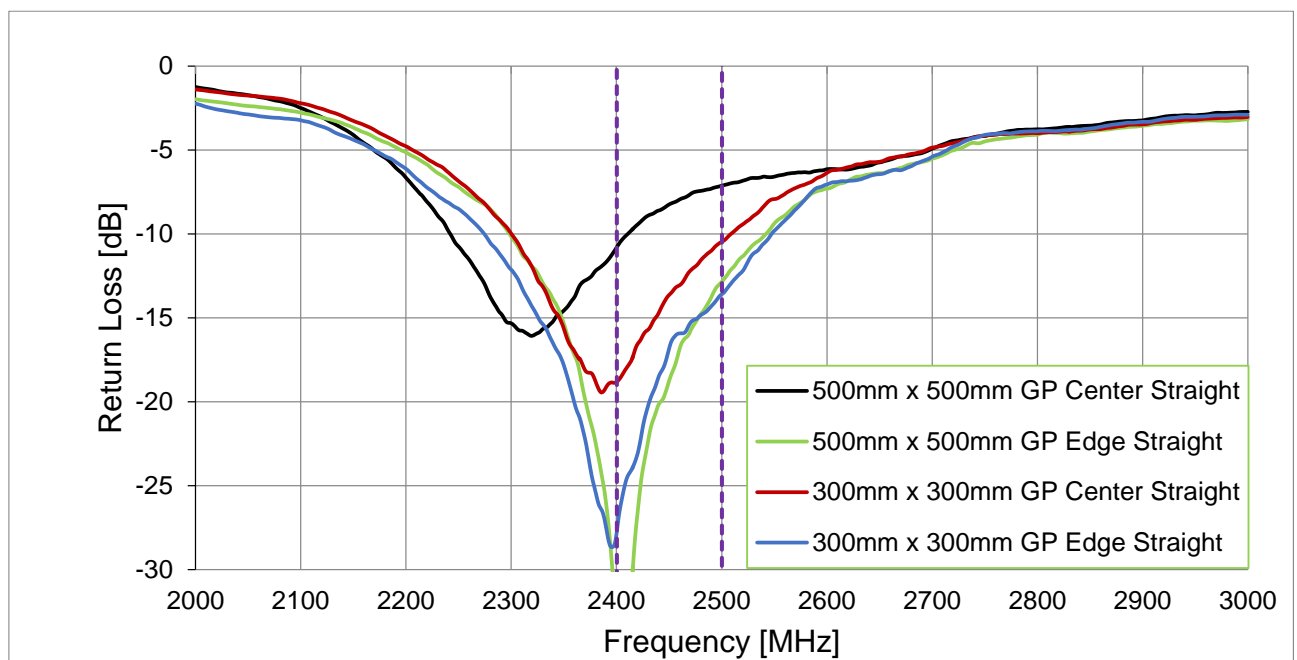
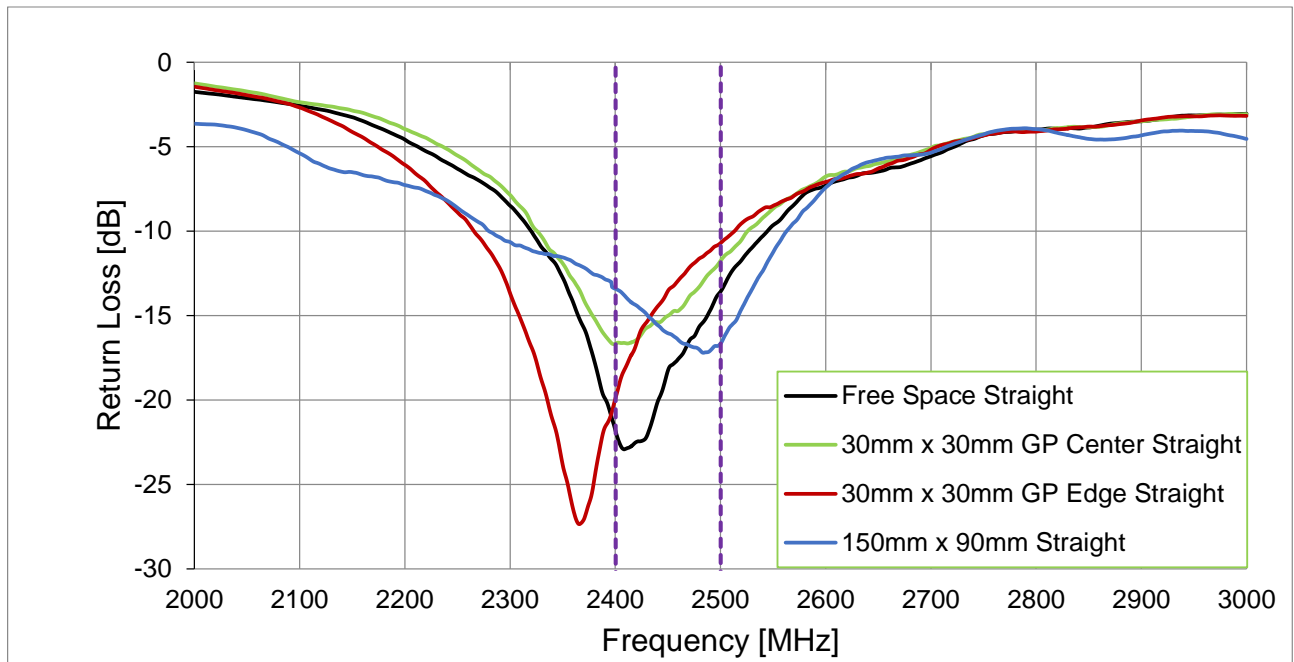

## 5.2 VSWR (Straight Antenna)

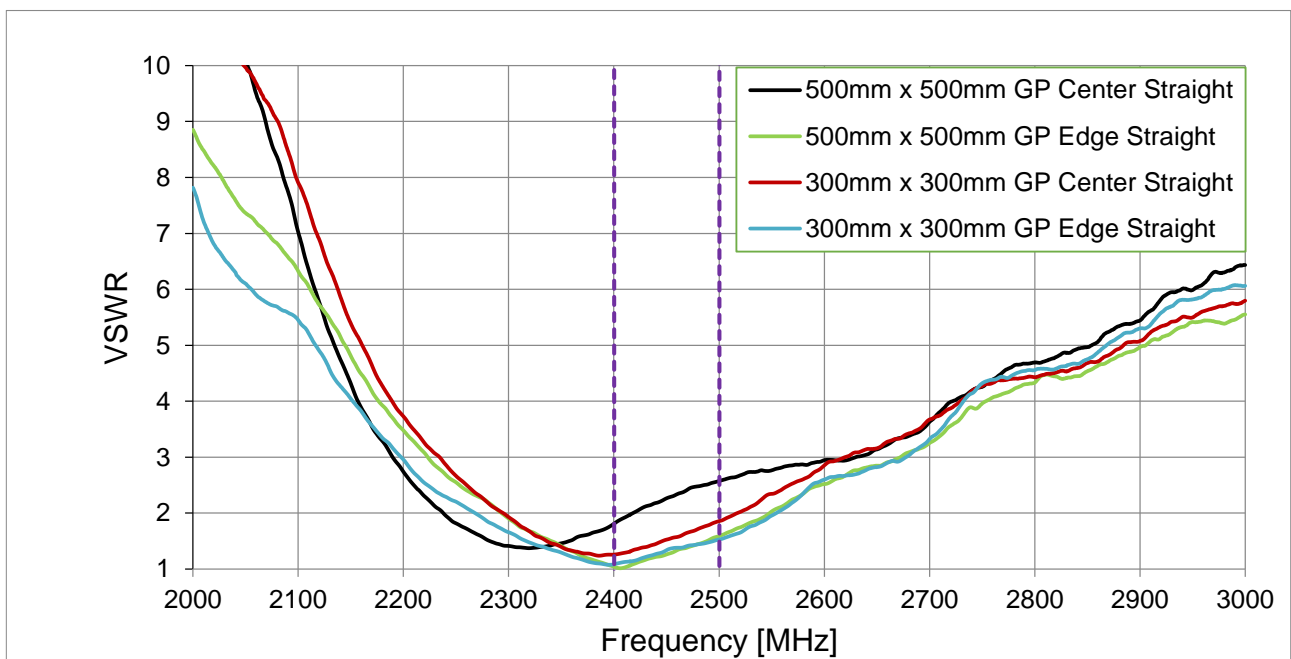
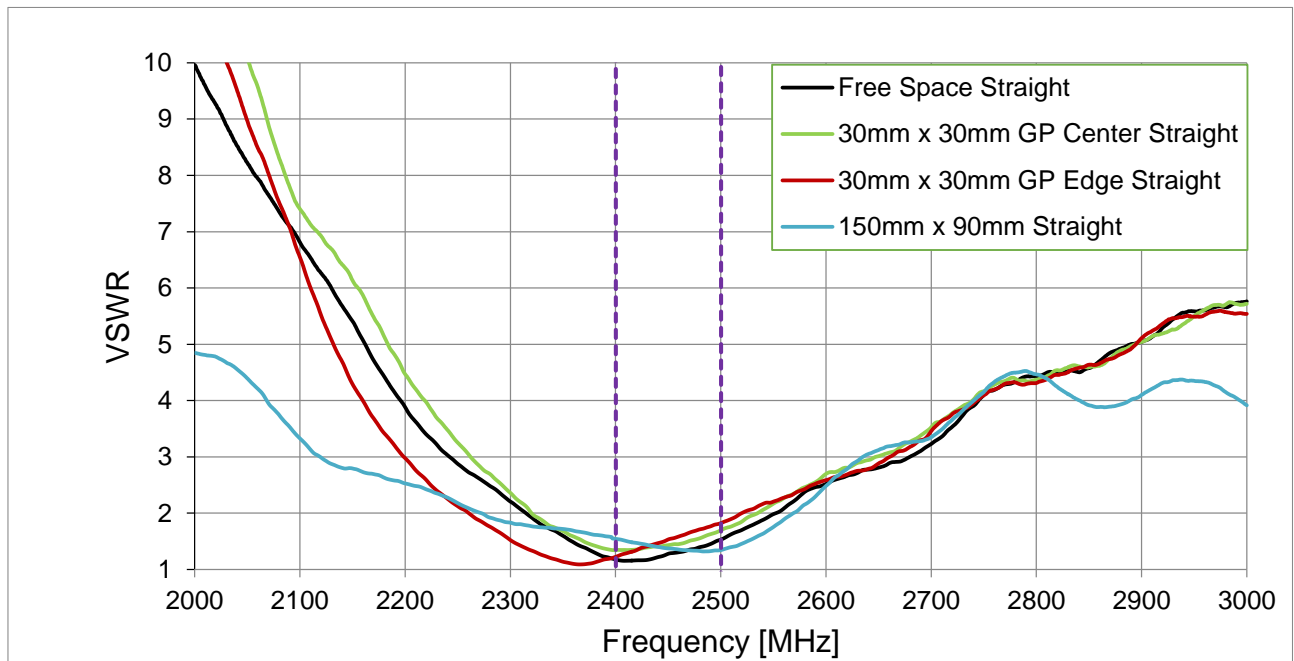

### 5.3 Efficiency (Straight Antenna)

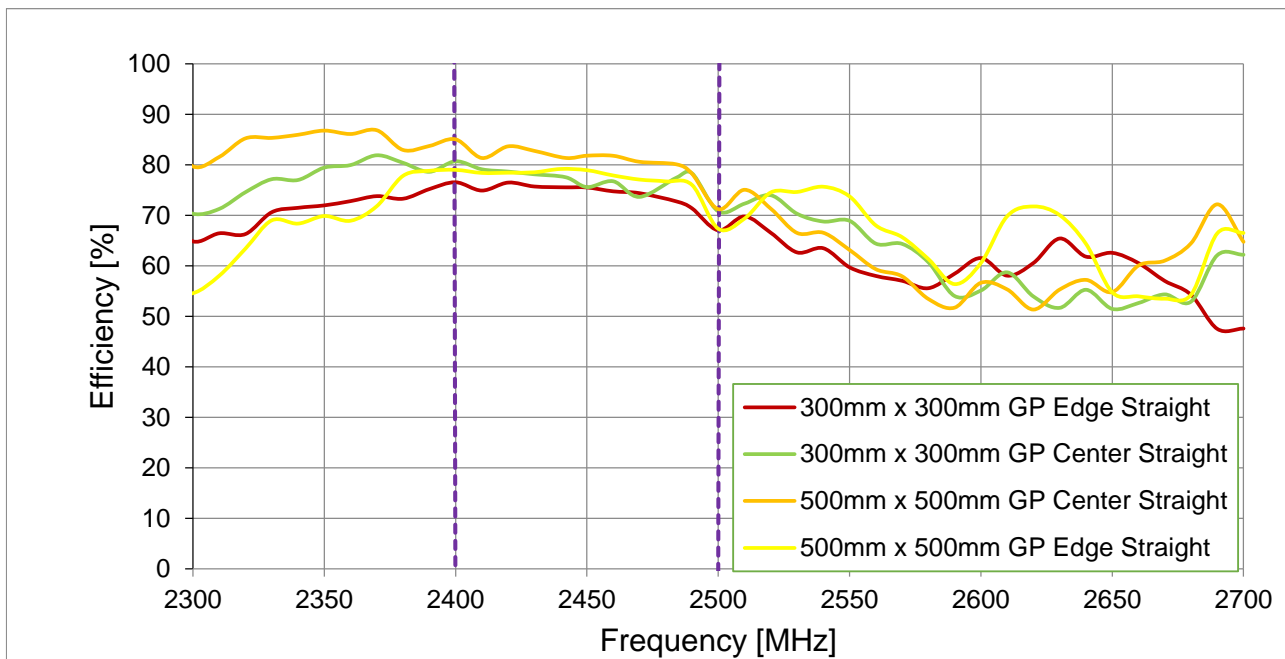
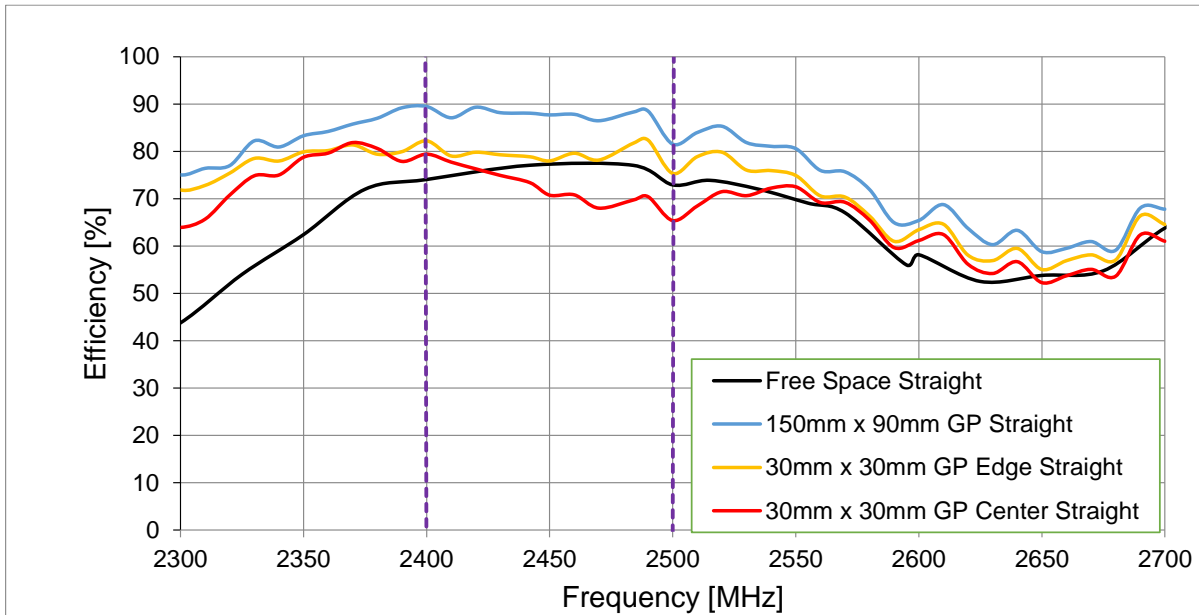

## 5.4 Peak Gain (Straight Antenna)

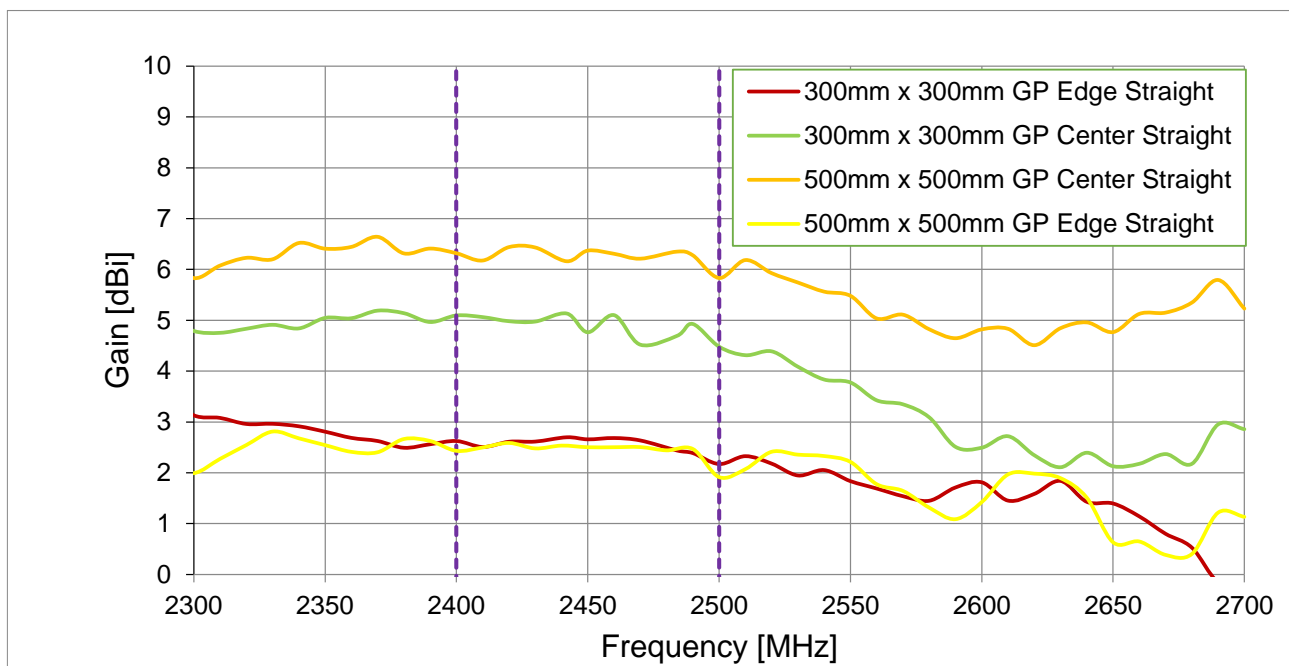
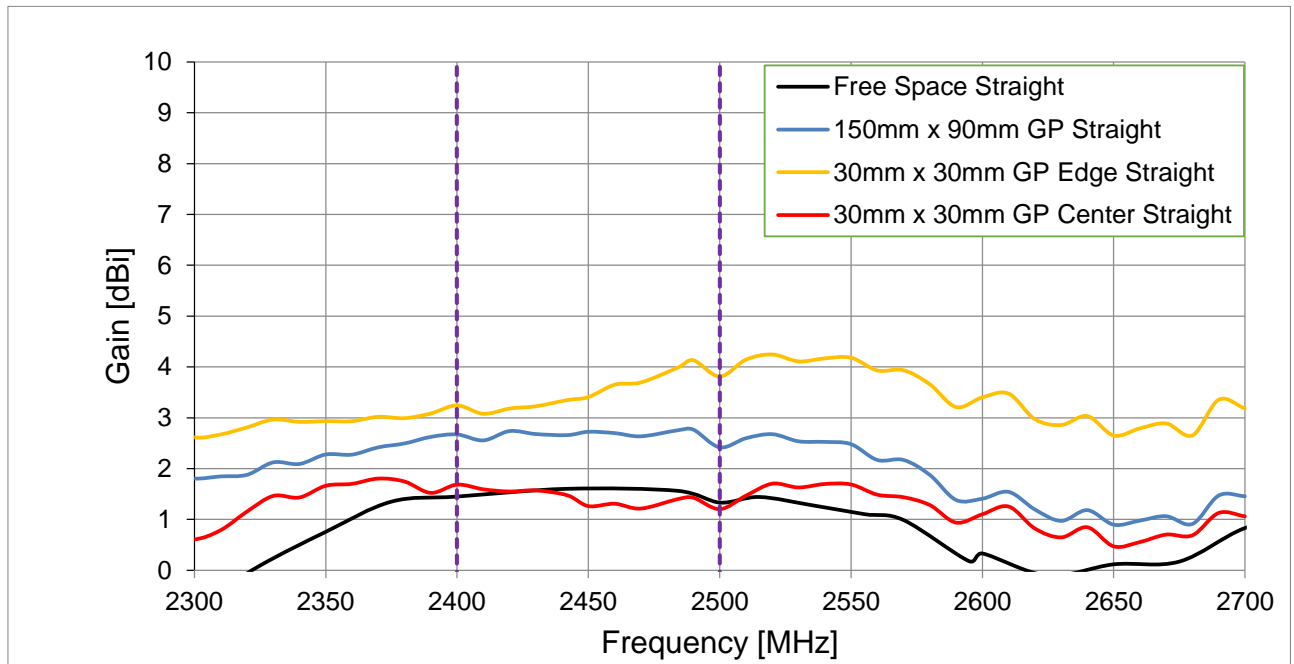



## 5.5 Average Gain (Straight Antenna)

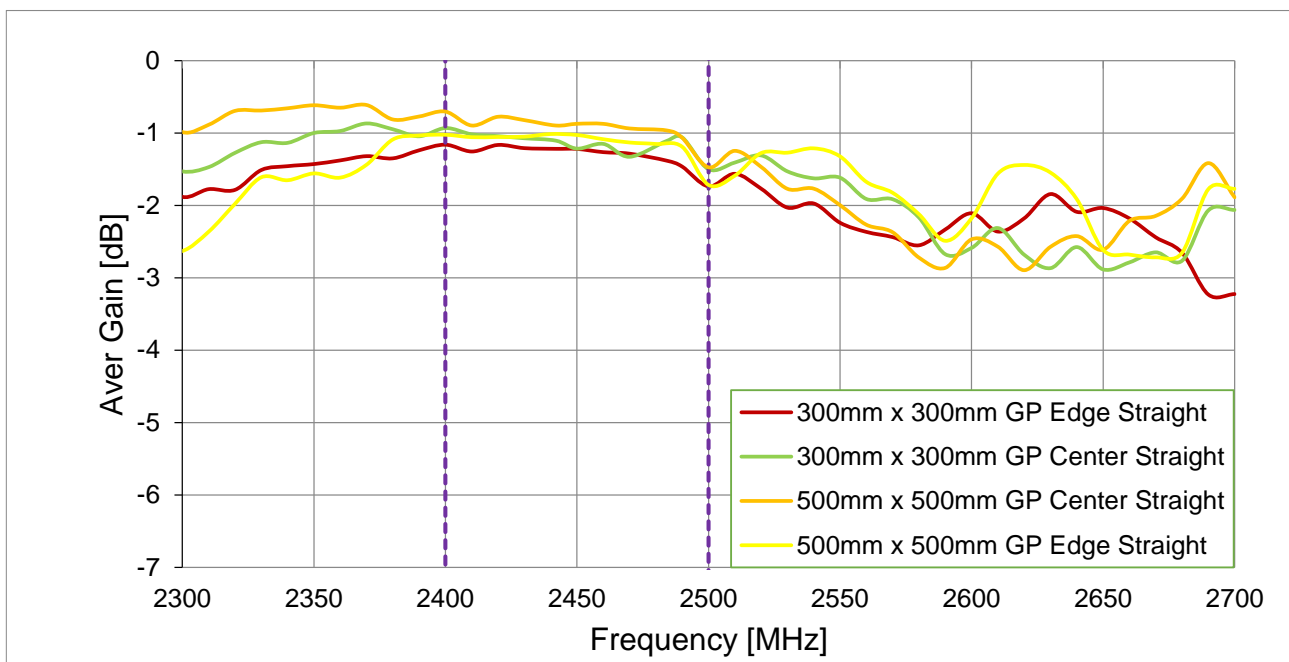
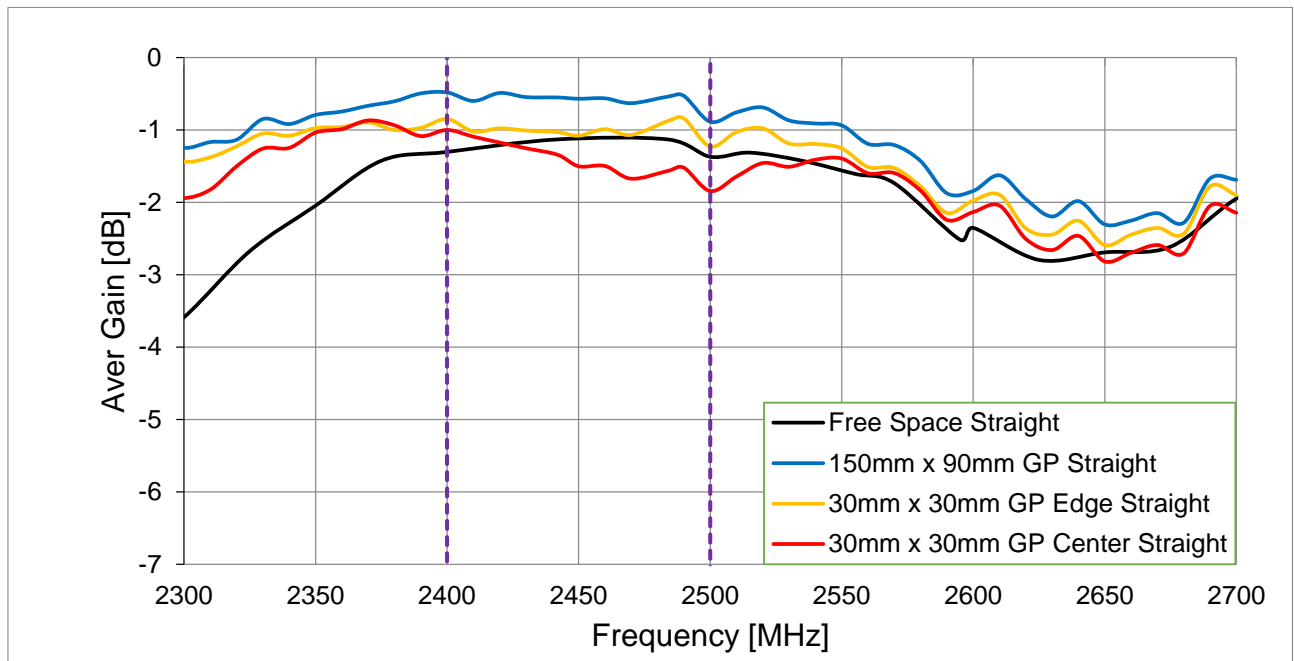

## 5.6 Return Loss (90° Bend)

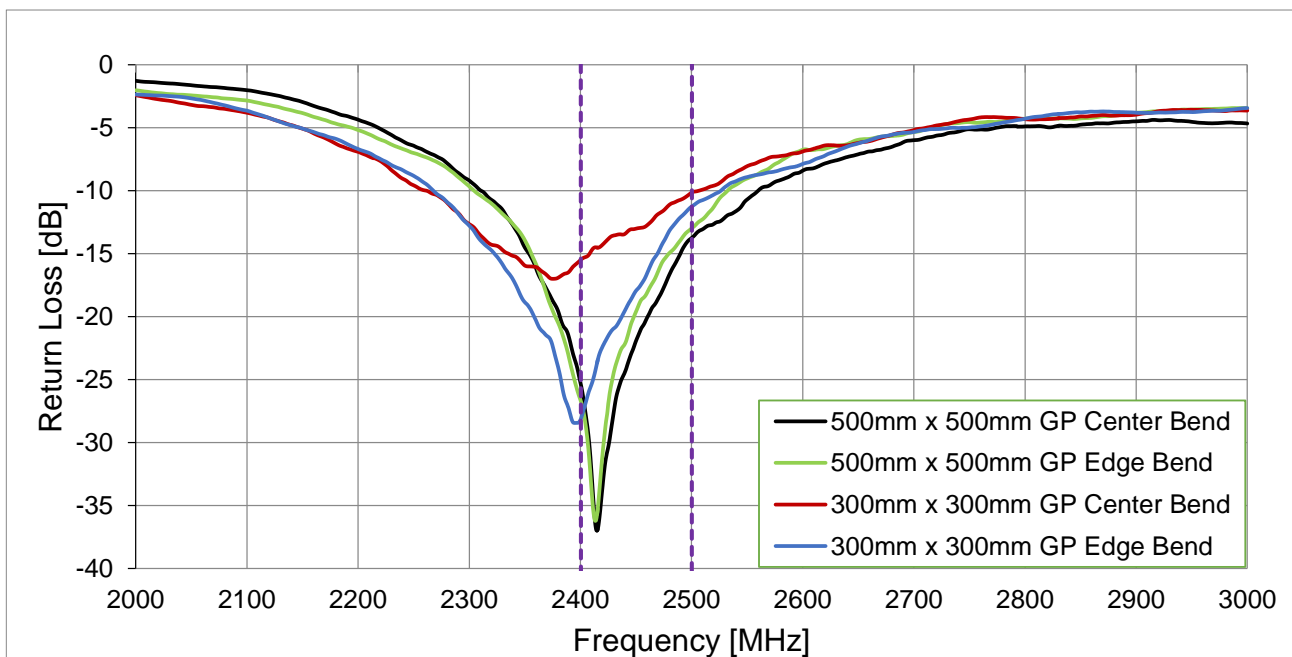
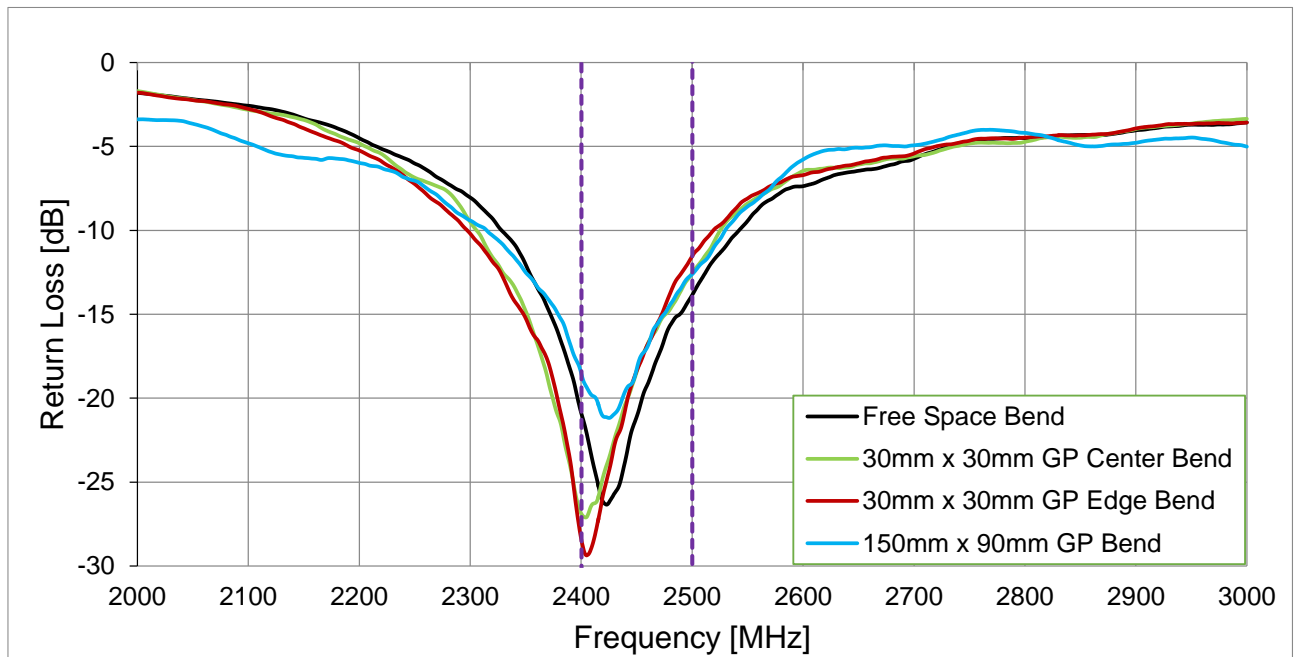

## 5.7 VSWR (90° Bend)

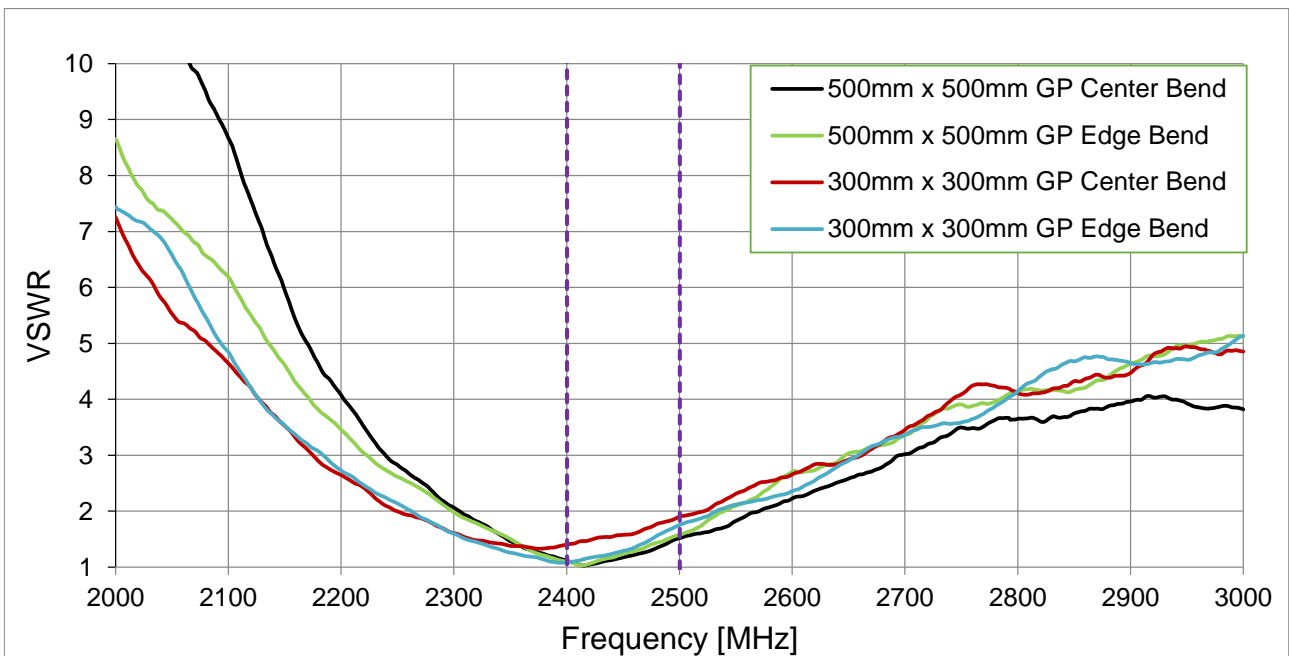
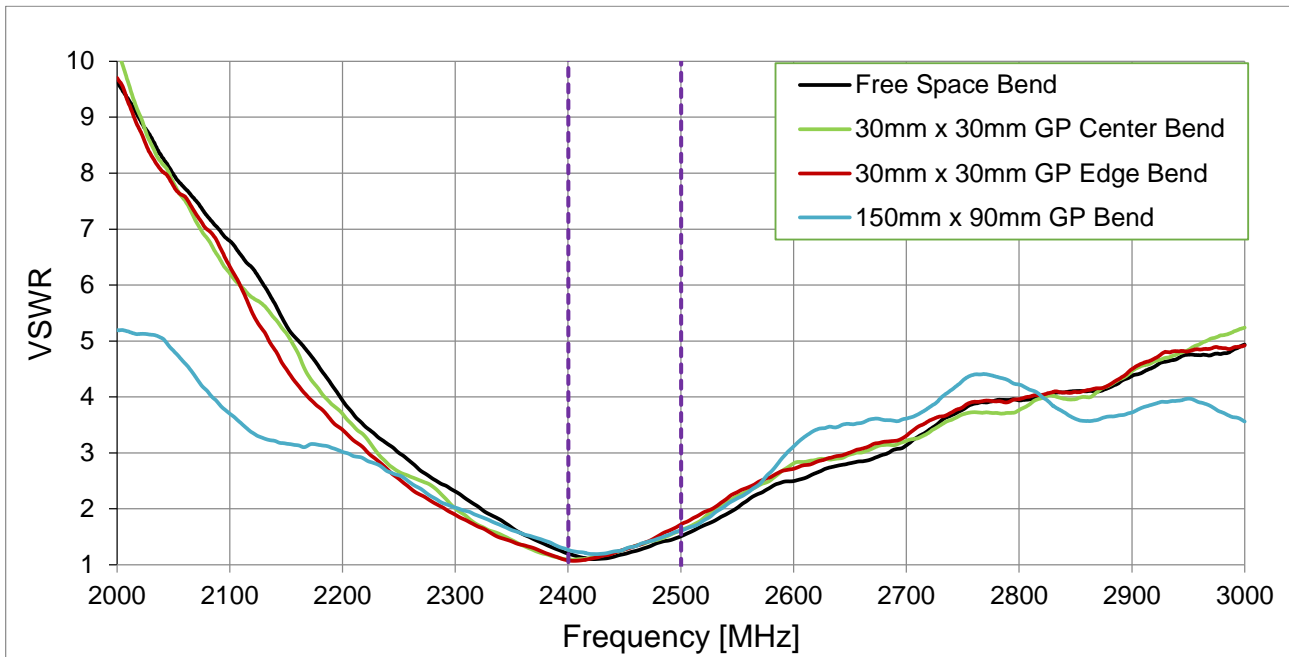

5.8 6.8 Efficiency (90° Bend)

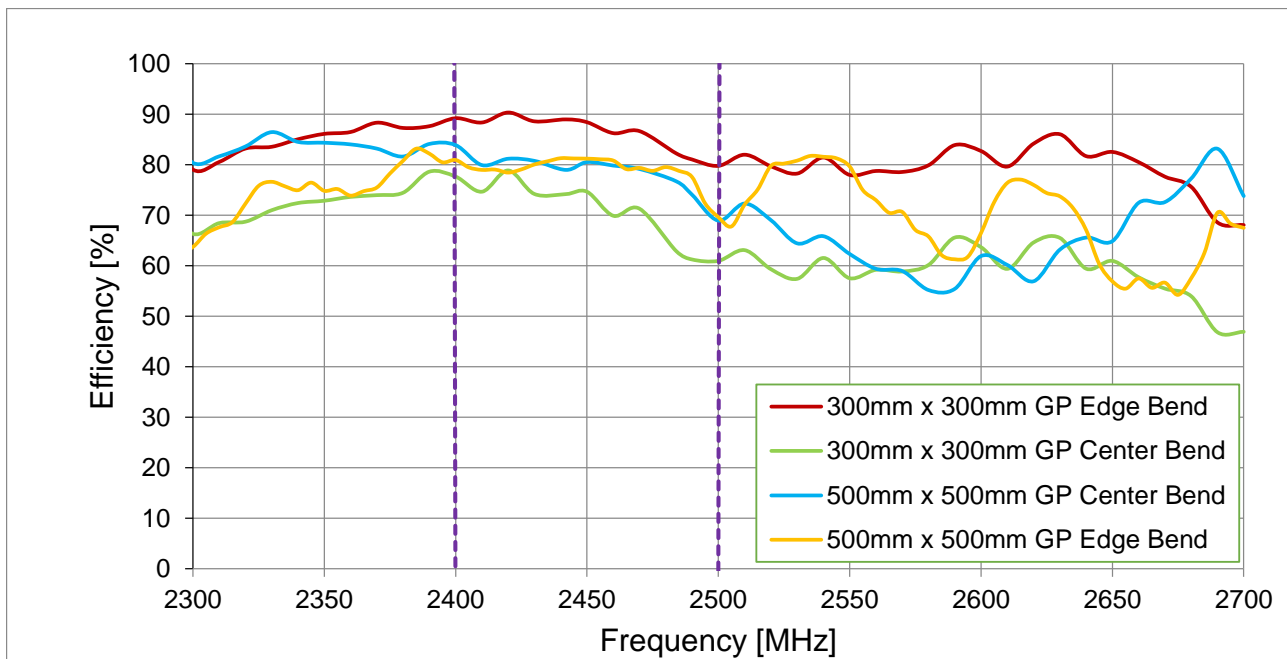
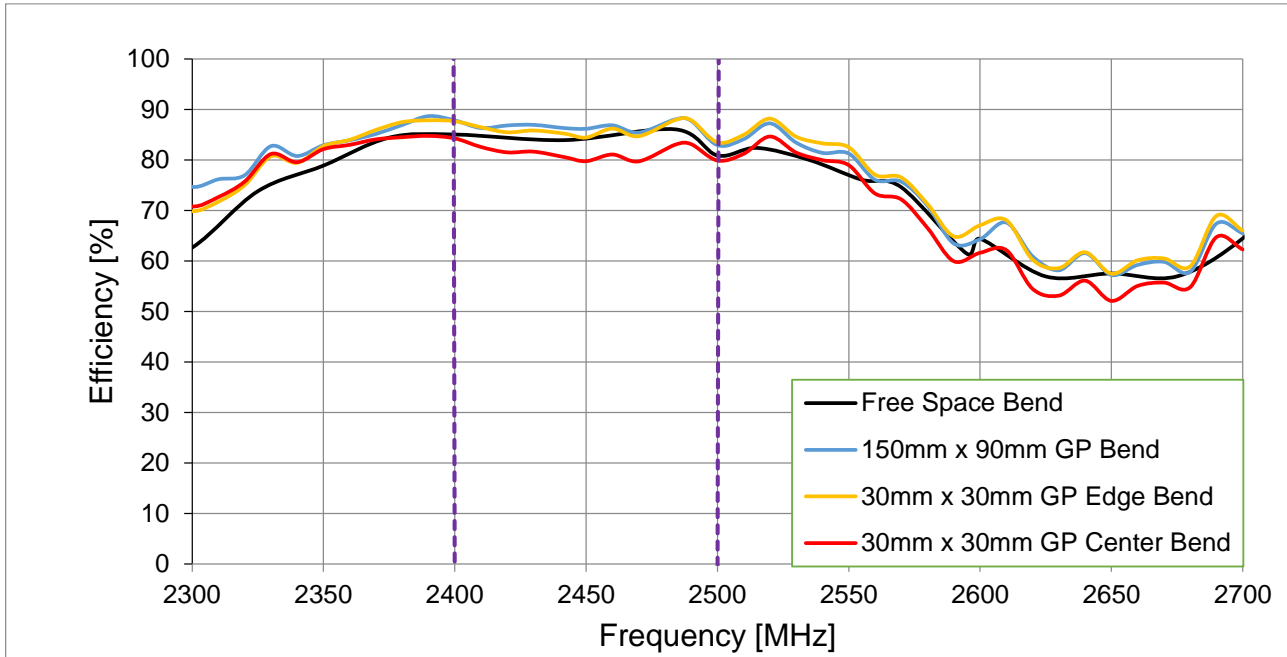

## 5.9 Peak Gain (90° Bend)

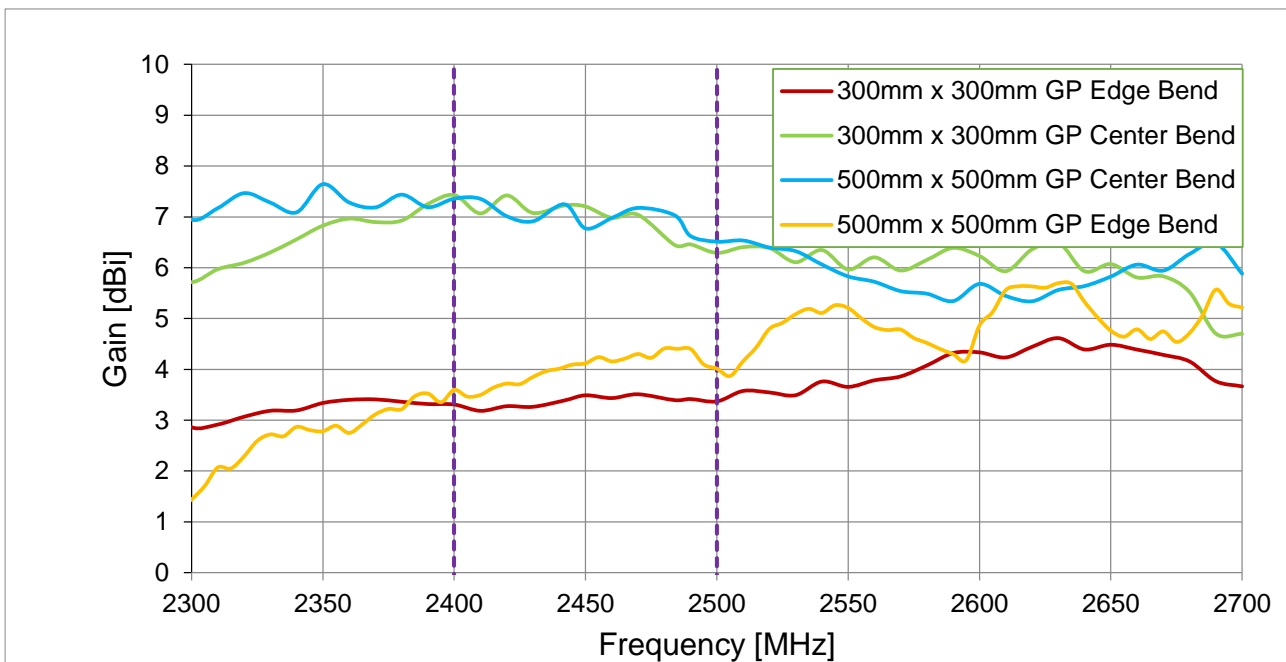
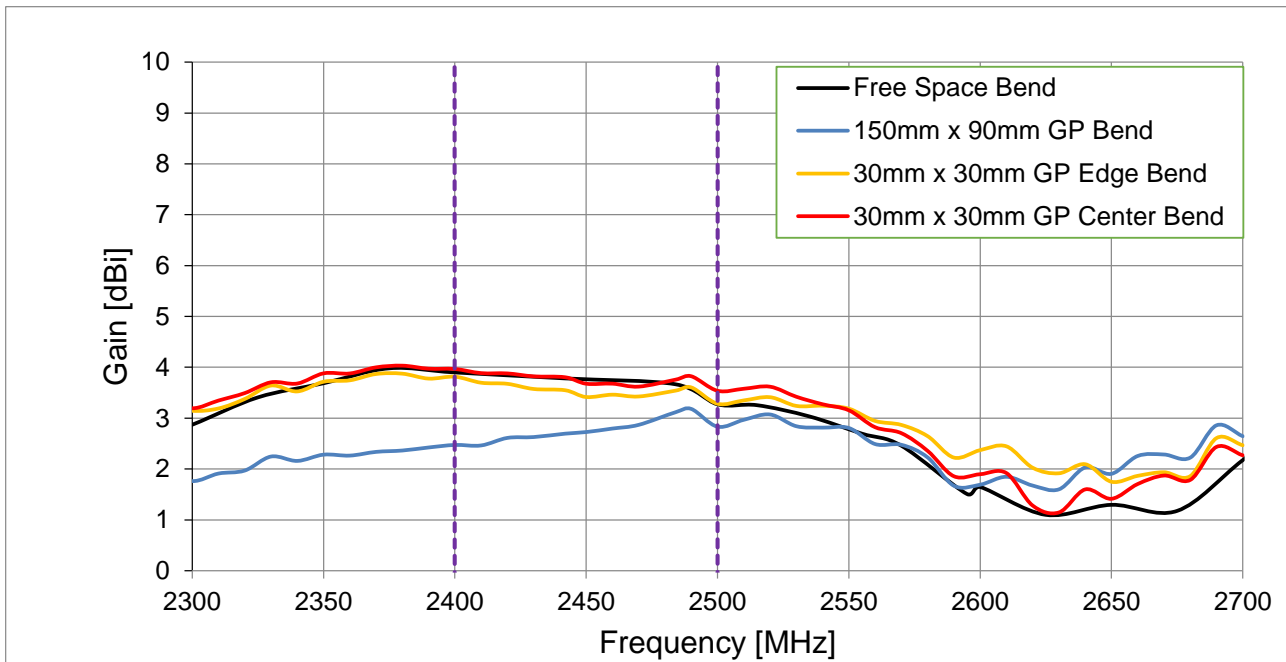

## 5.10 Average Gain (90° Bend)

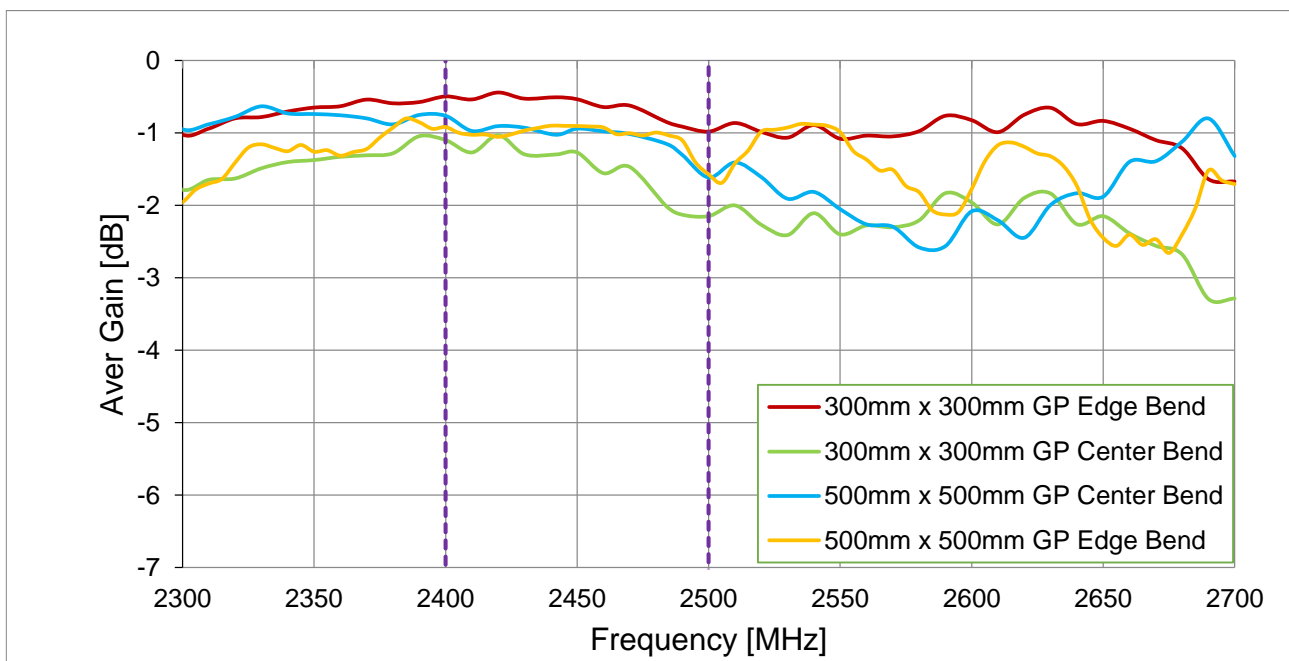
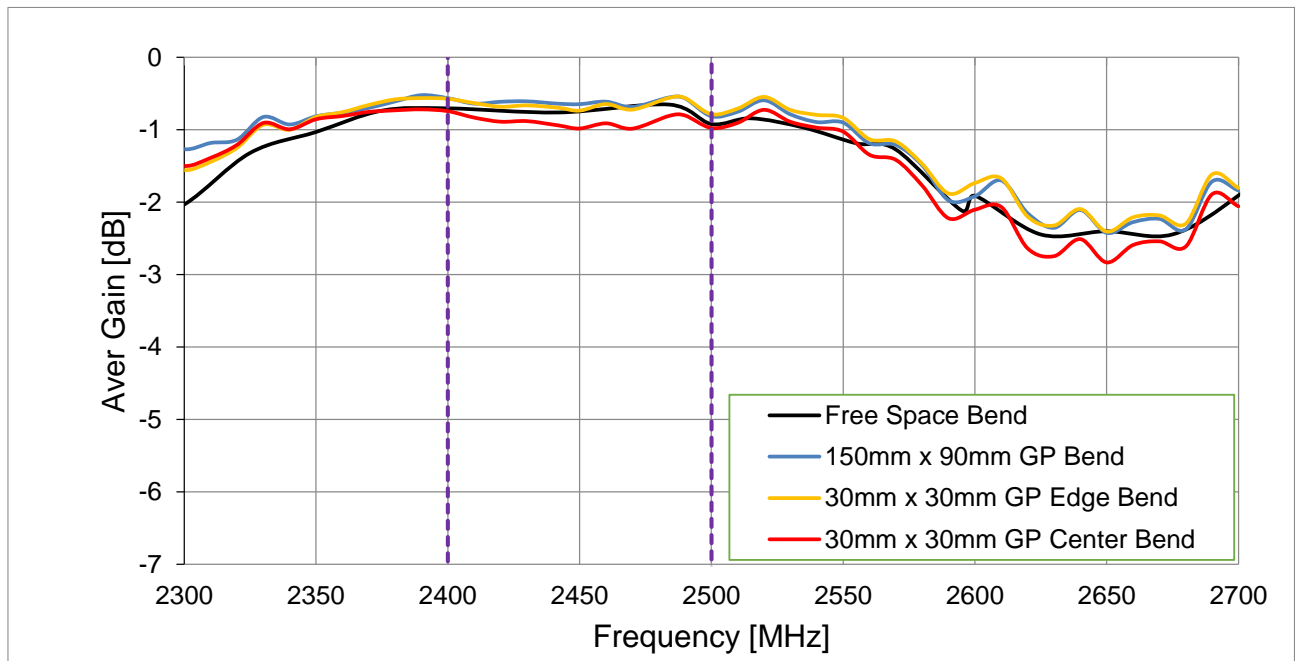

## 6. Radiation Patterns

### 6.1 GW.15 Straight at 2.4GHz

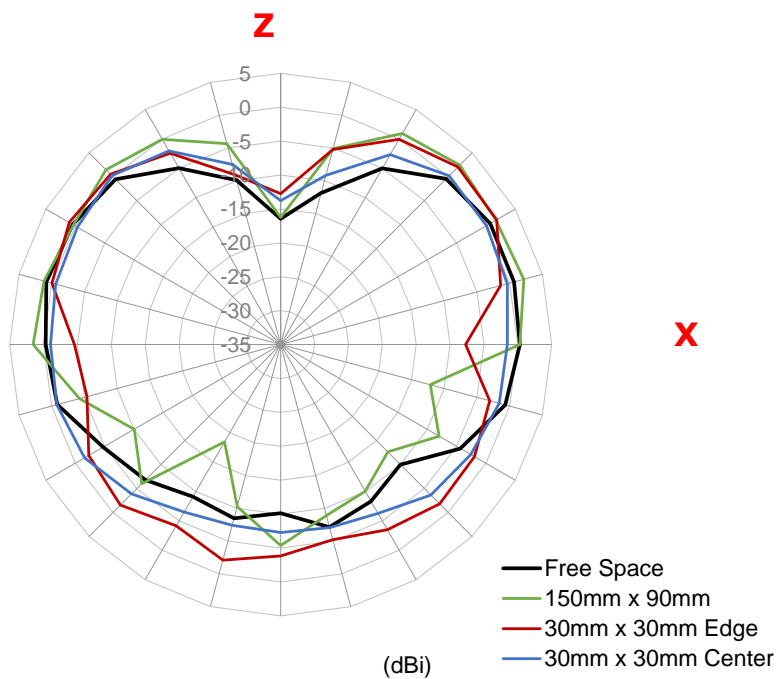
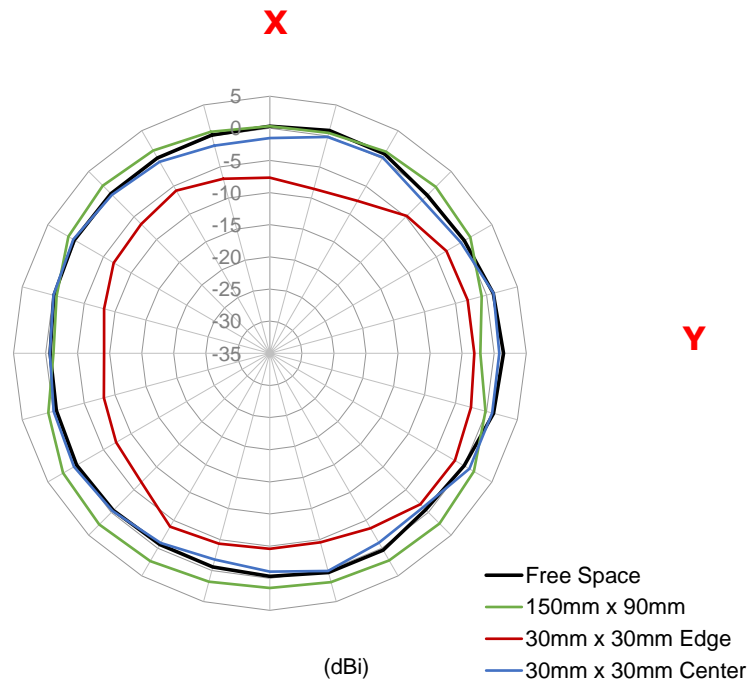

**Z**

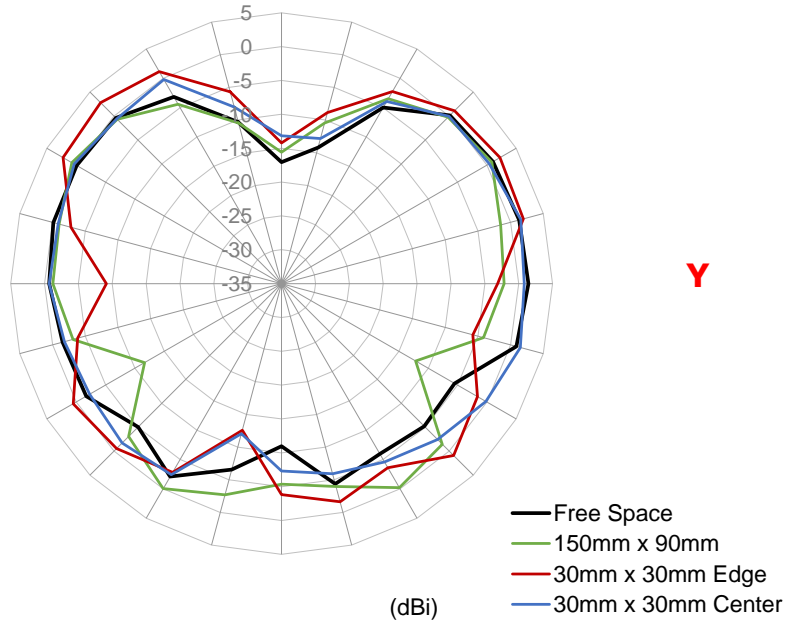

**X**

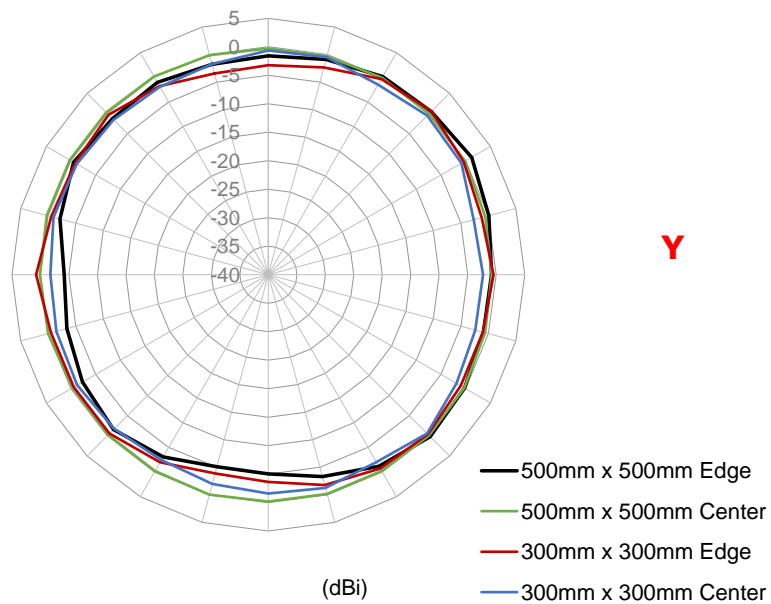



**Z**

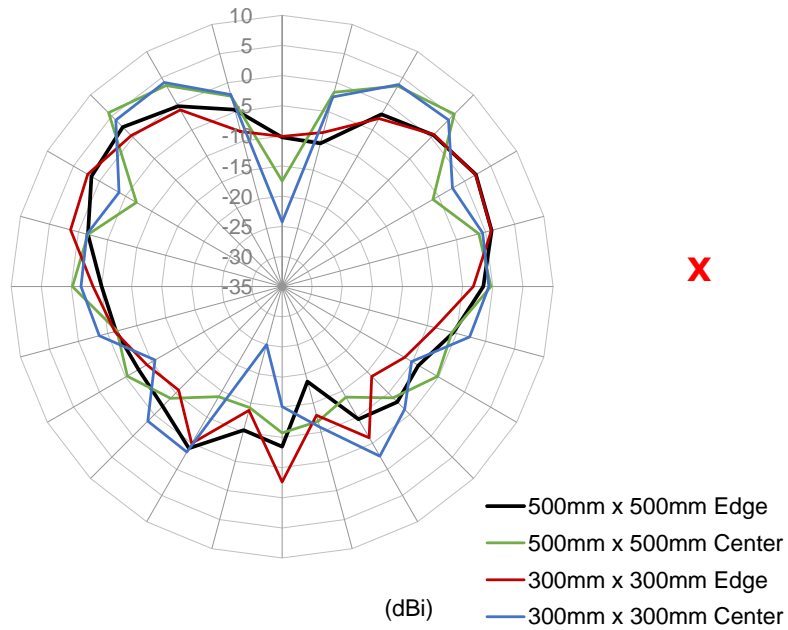

**X**

**Z**

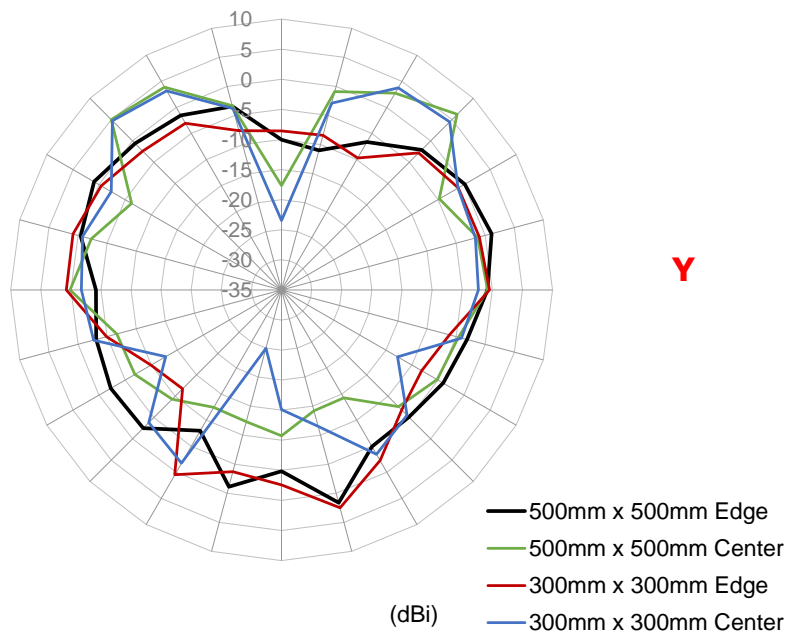

**Y**

6.2 GW.15 Straight at 2.45GHz

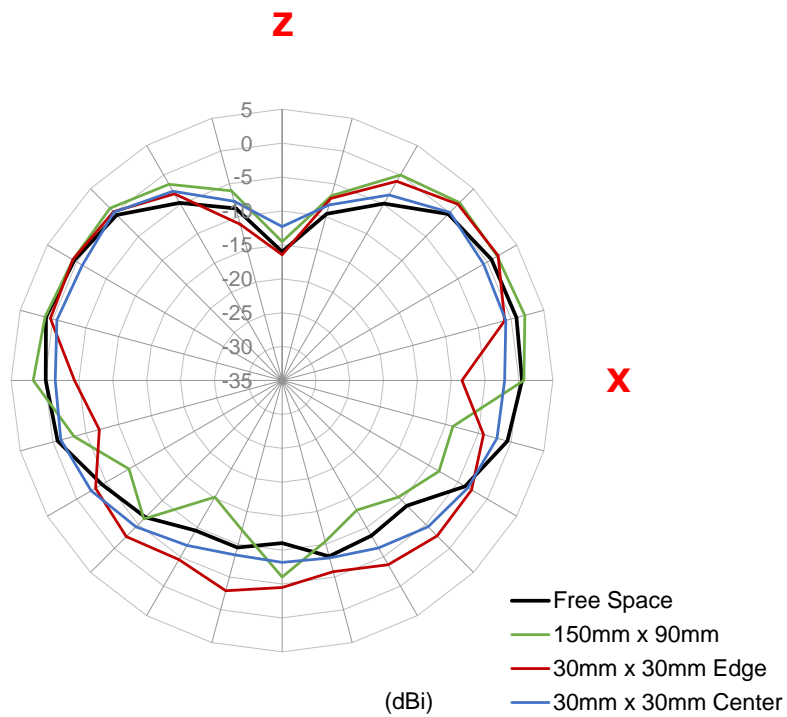
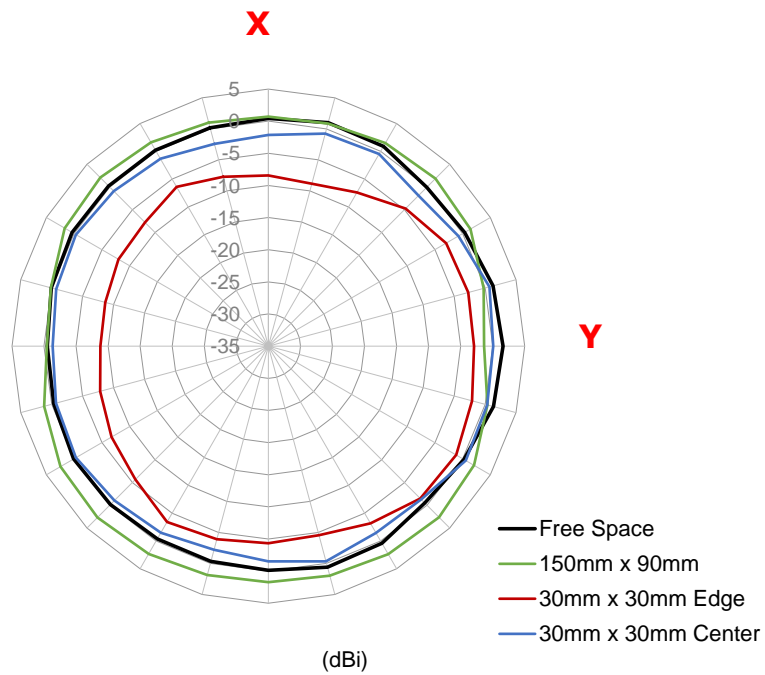

**Z**

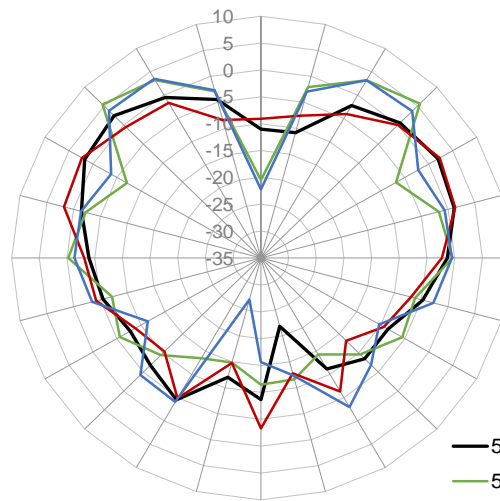

**Y**

- 500mm x 500mm Edge
  - 500mm x 500mm Center
  - 300mm x 300mm Edge
  - 300mm x 300mm Center
- (dBi)

**X**

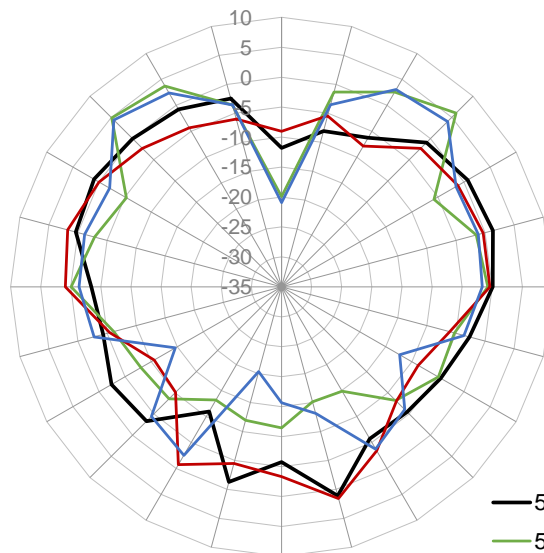

**Y**

- 500mm x 500mm Edge
  - 500mm x 500mm Center
  - 300mm x 300mm Edge
  - 300mm x 300mm Center
- (dBi)

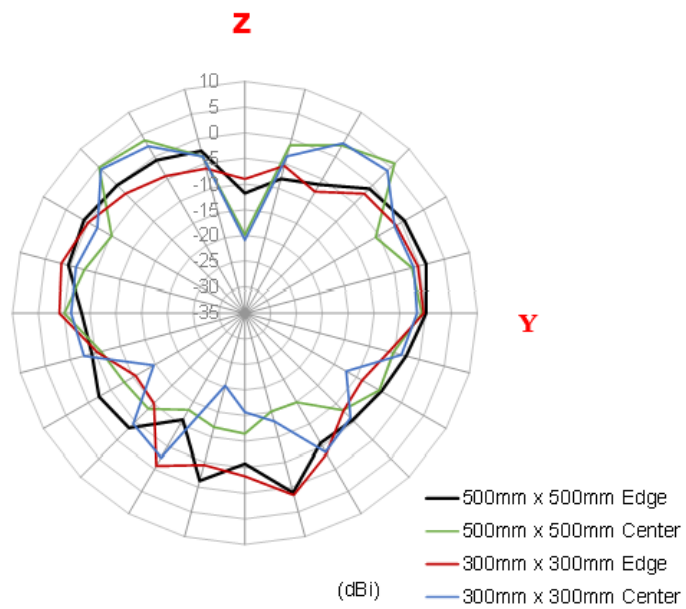
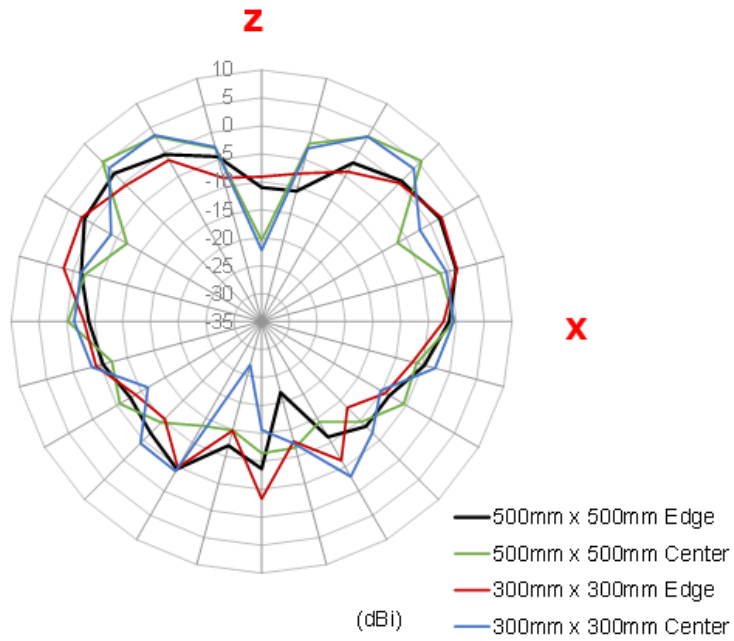

6.3 GW.15 Straight at 2.5GHz

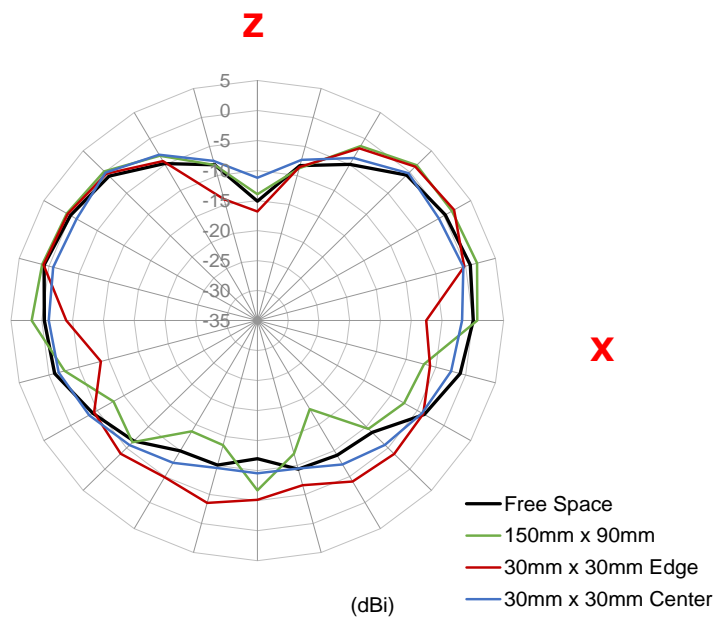
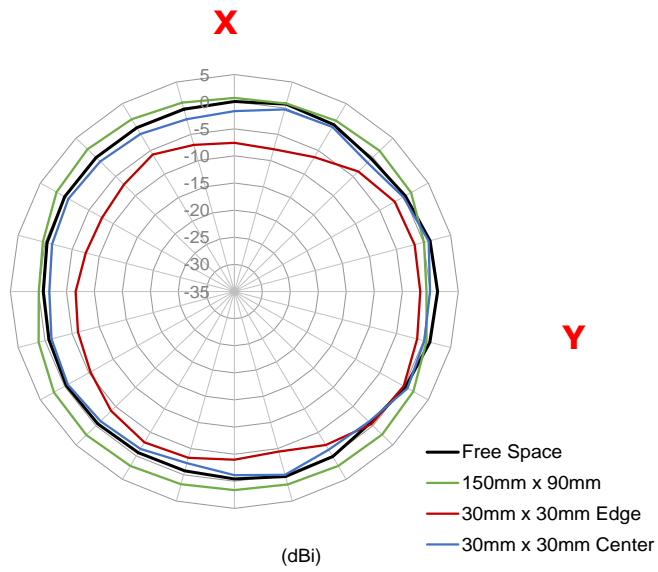

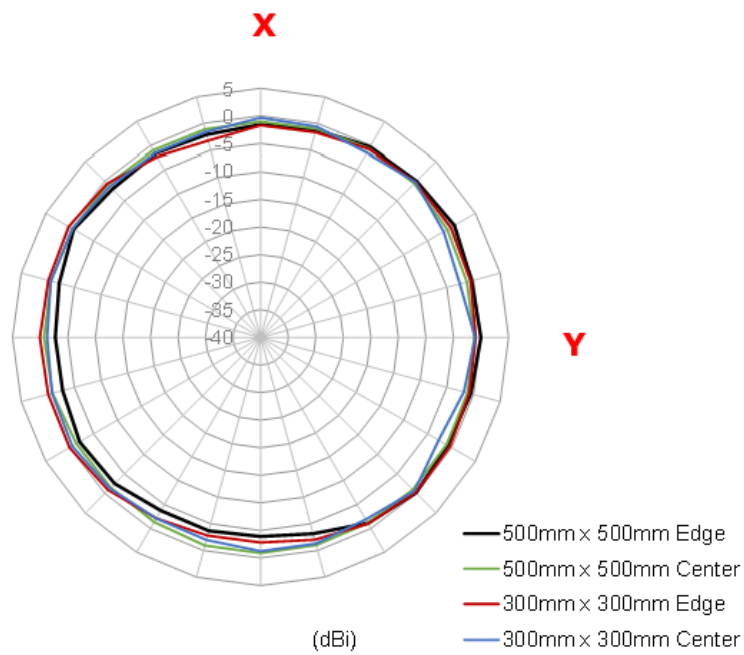
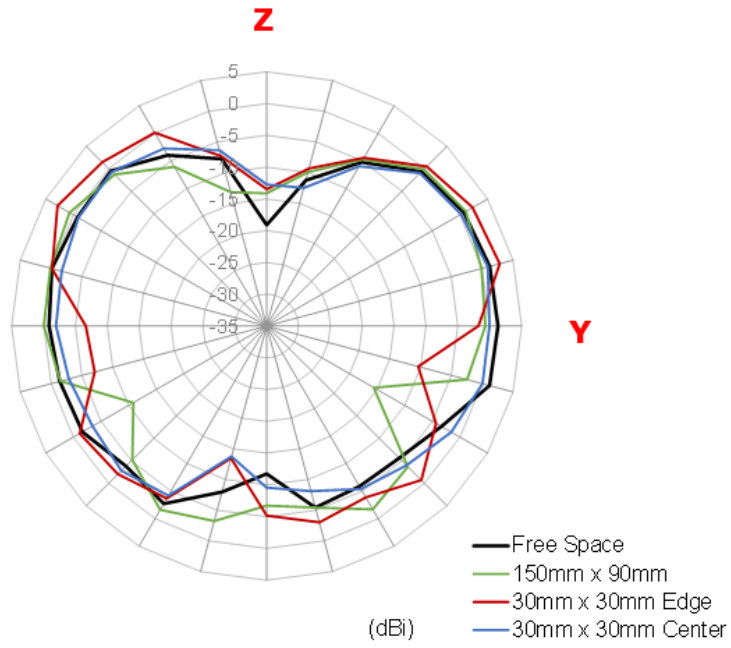

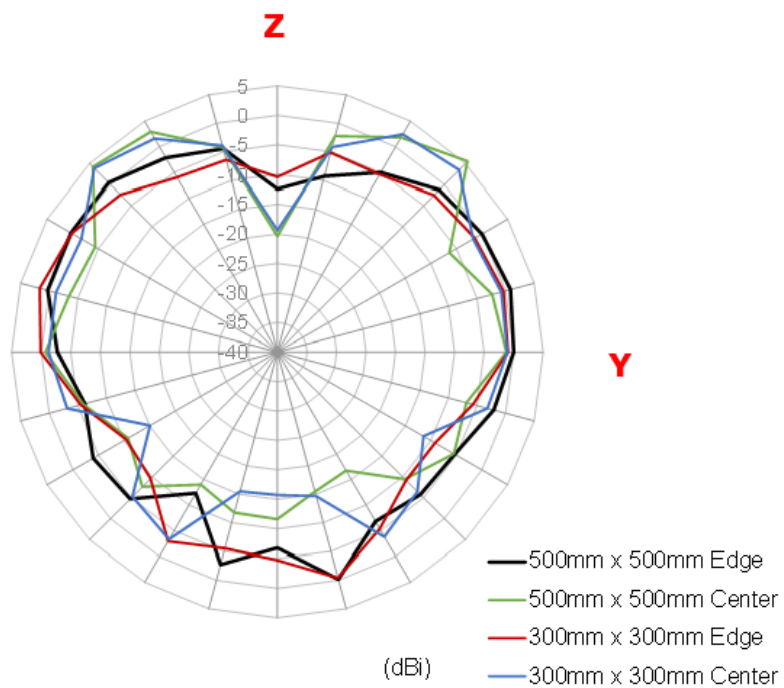
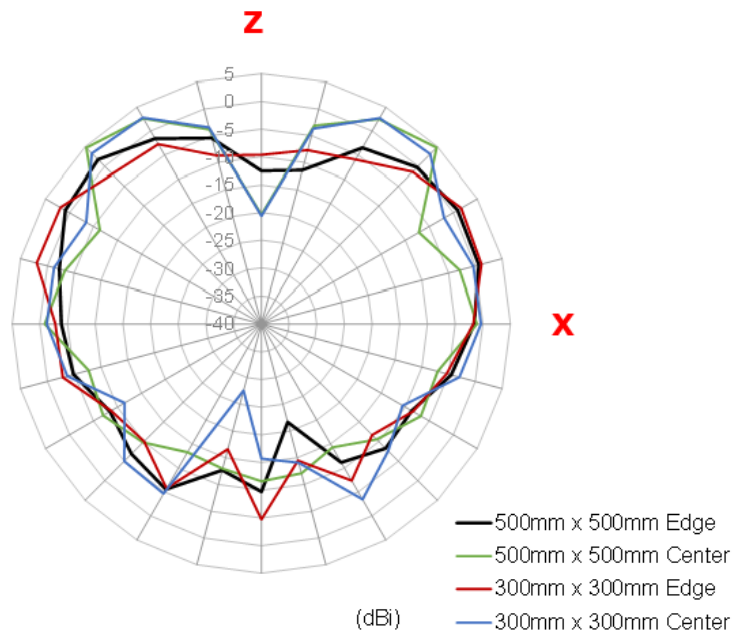

6.4 GW.15 90° Bend at 2.4GHz

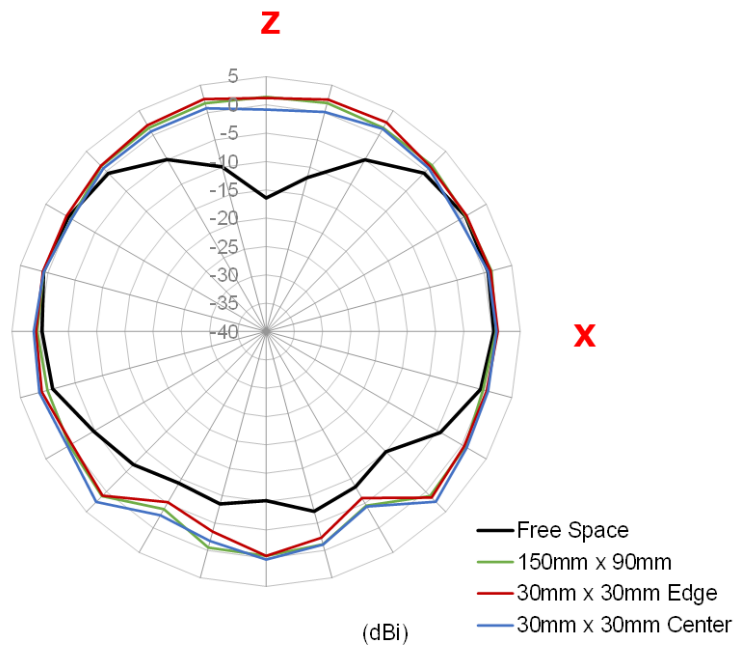
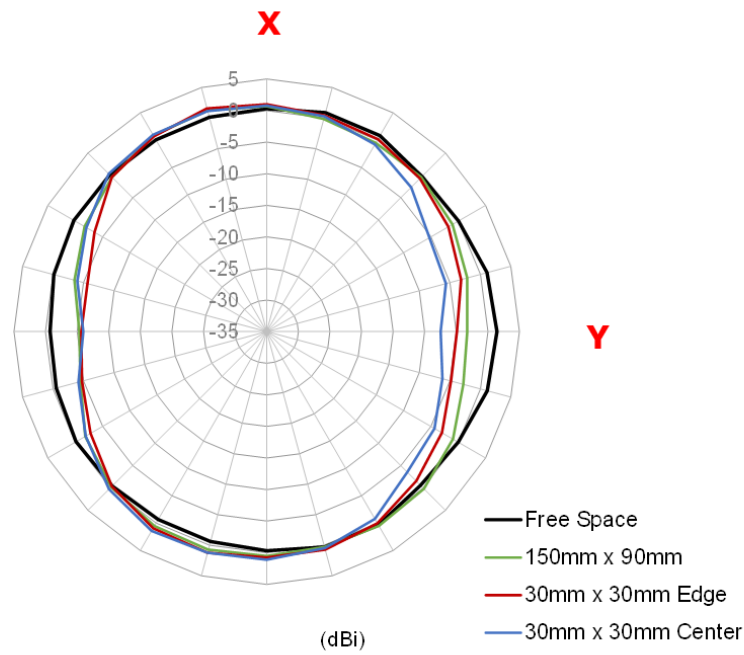



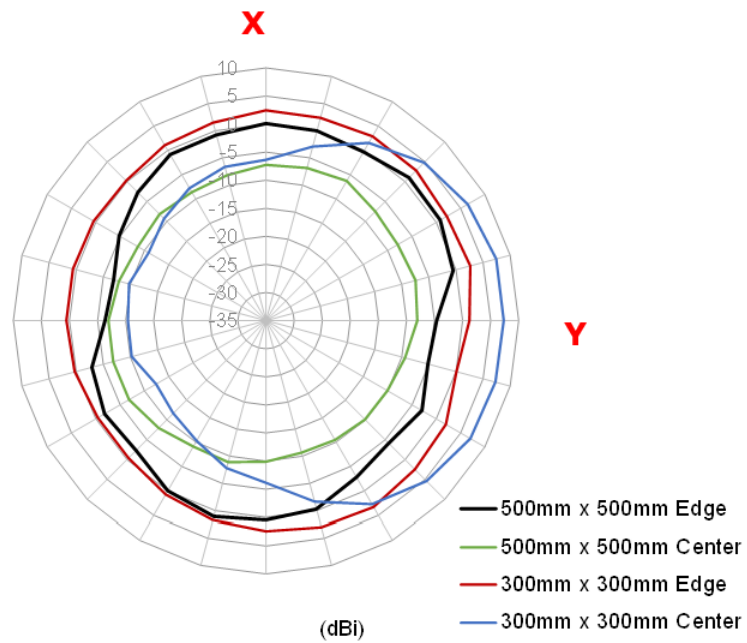
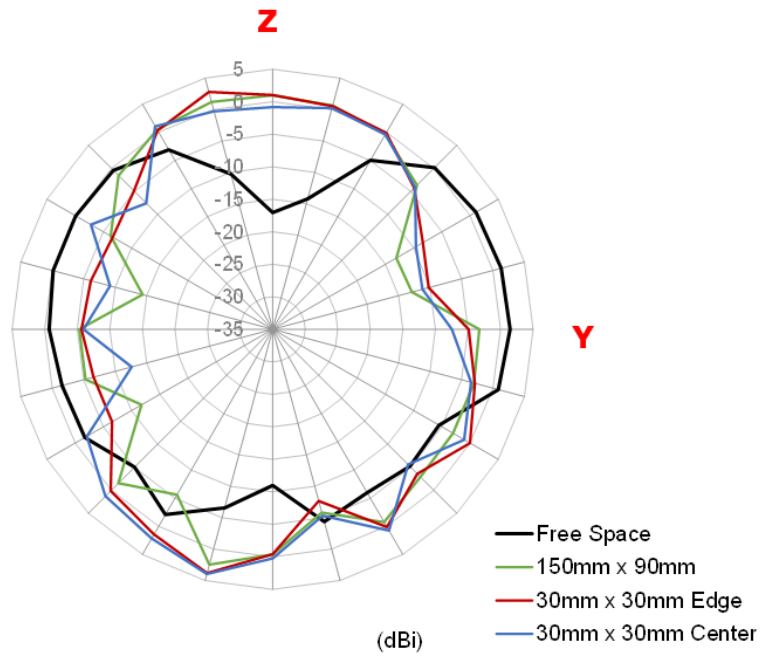

**Z**

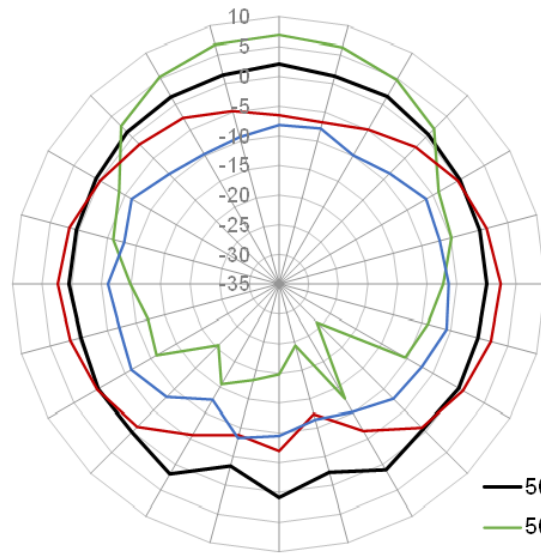

**X**

- 500mm x 500mm Edge
  - 500mm x 500mm Center
  - 300mm x 300mm Edge
  - 300mm x 300mm Center
- (dBi)

**Z**

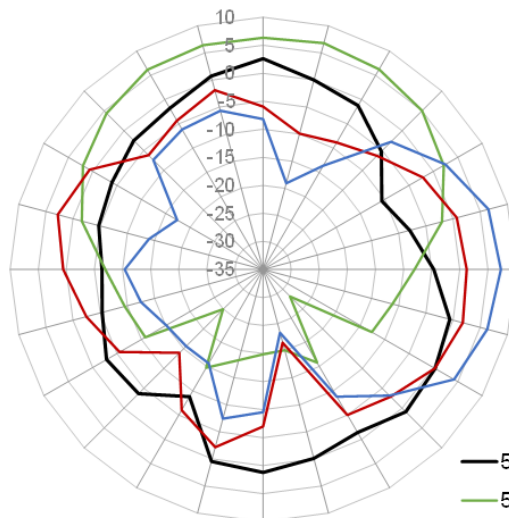

**Y**

- 500mm x 500mm Edge
  - 500mm x 500mm Center
  - 300mm x 300mm Edge
  - 300mm x 300mm Center
- (dBi)

6.5 GW.15 90° Bend at 2.45GHz

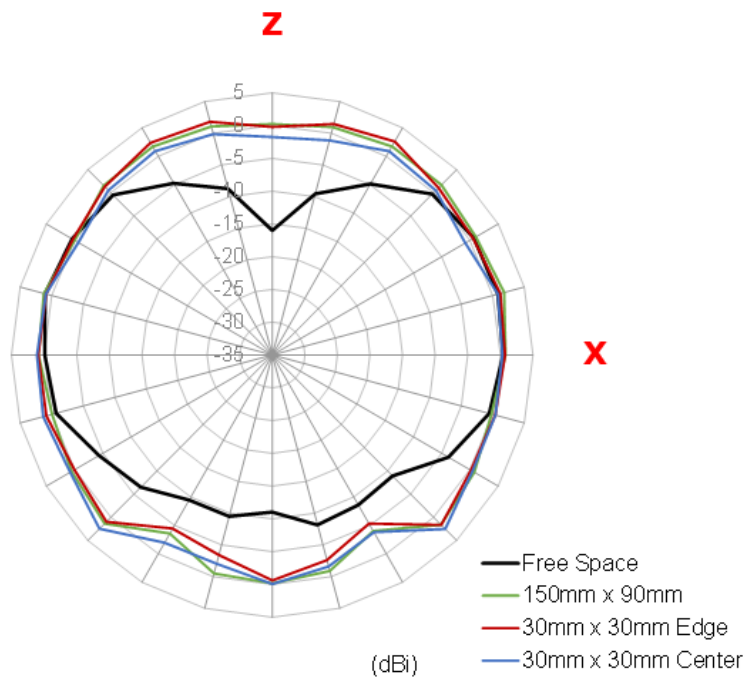
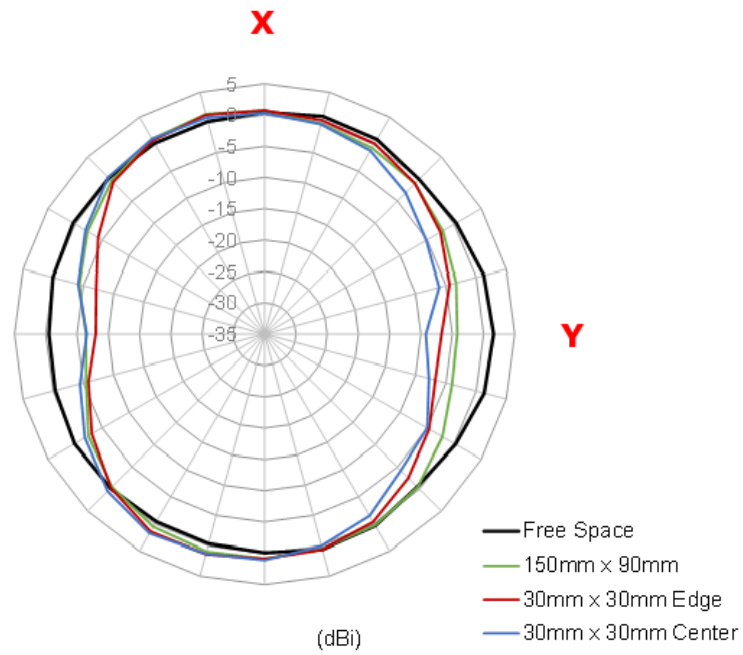

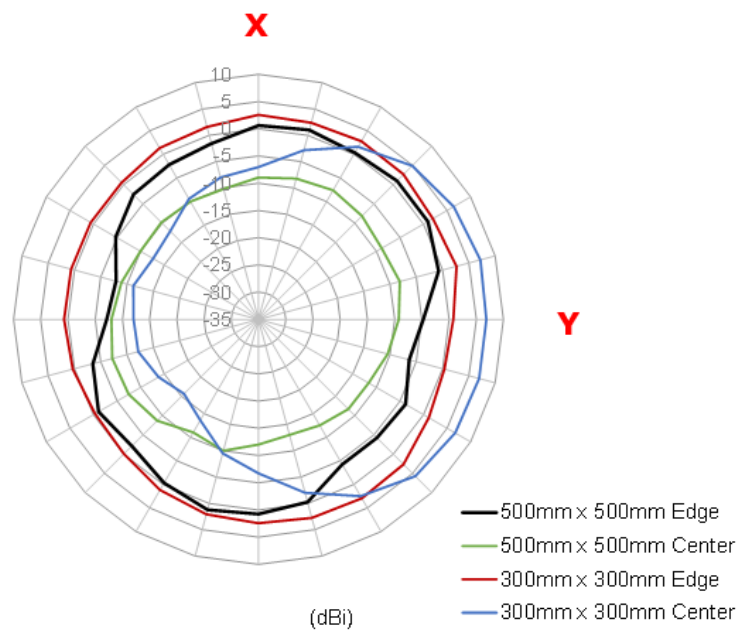
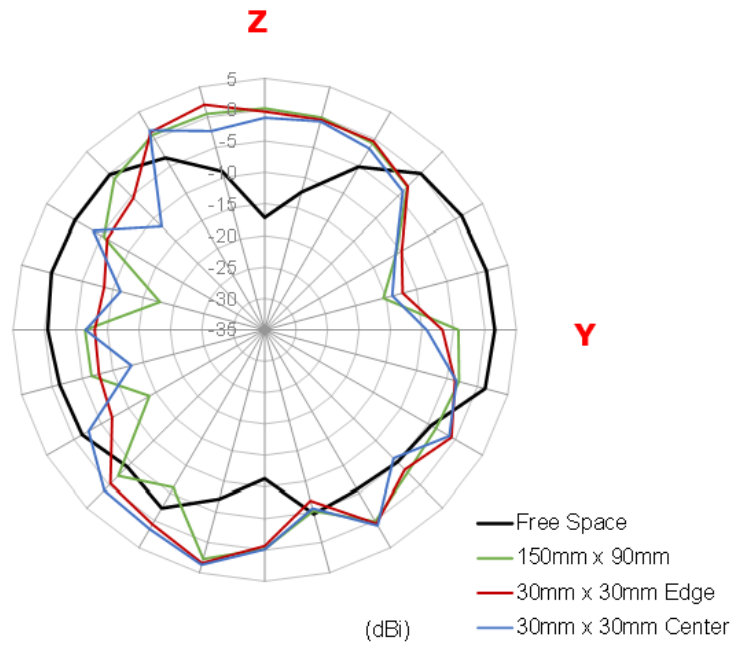

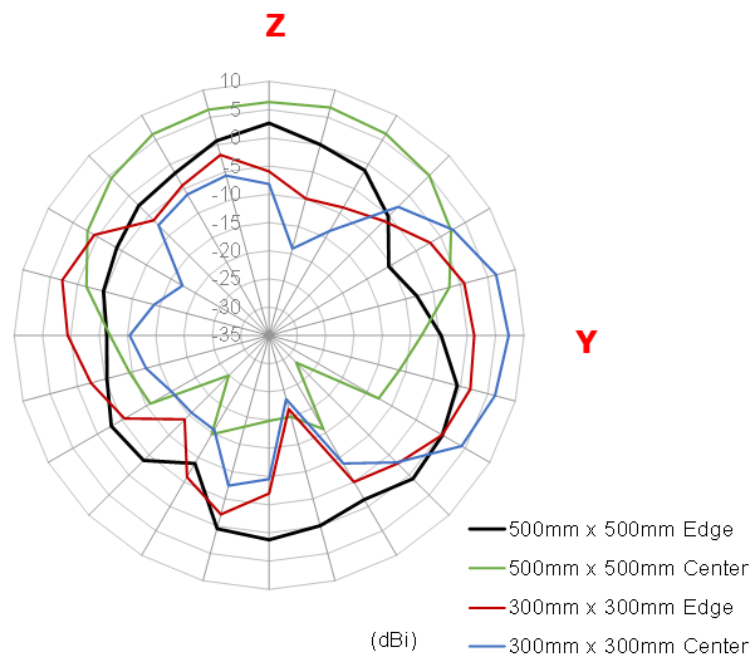
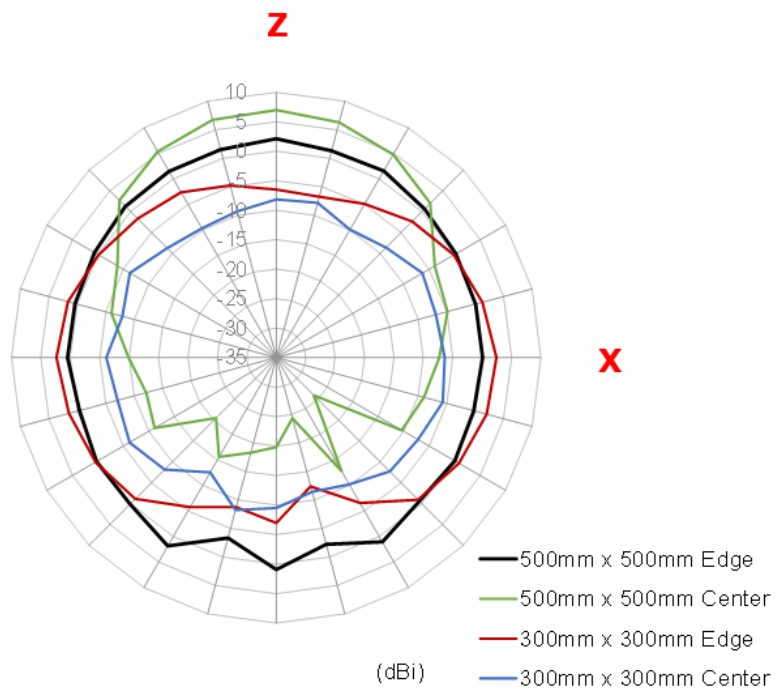

6.6 GW.15 90° Bend at 2.5GHz

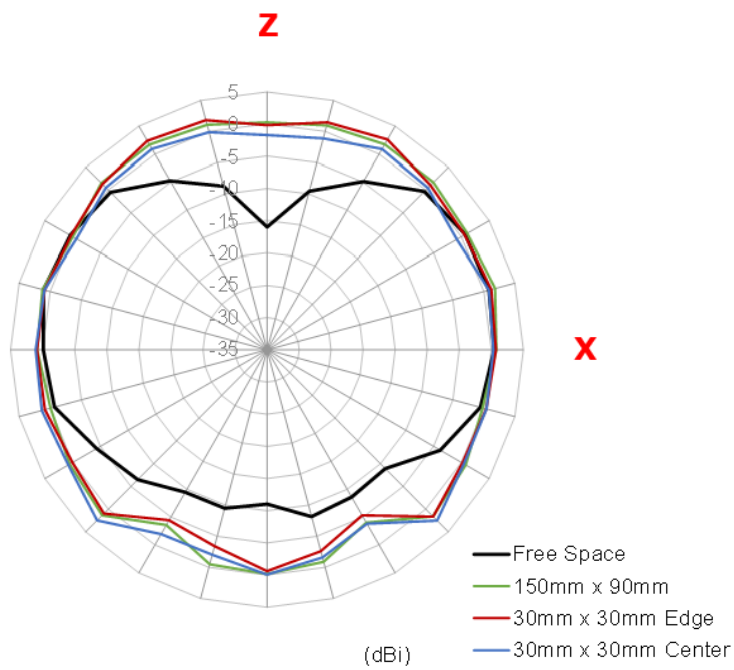
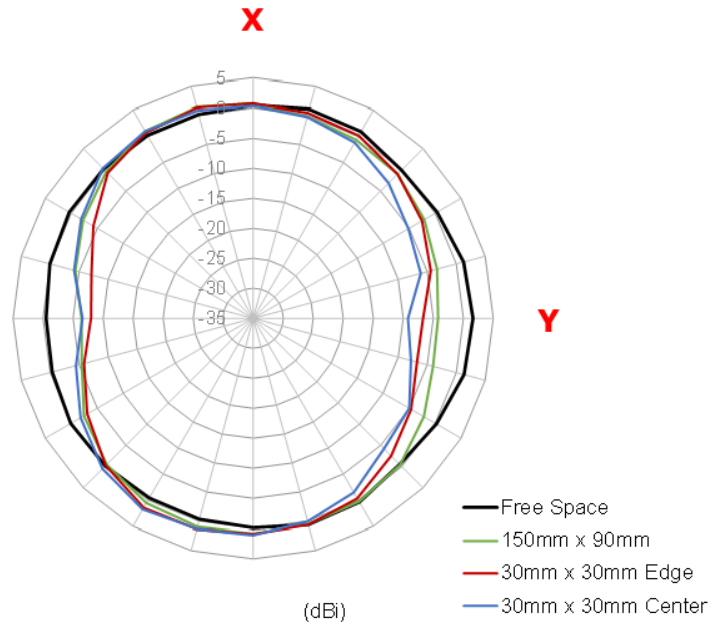

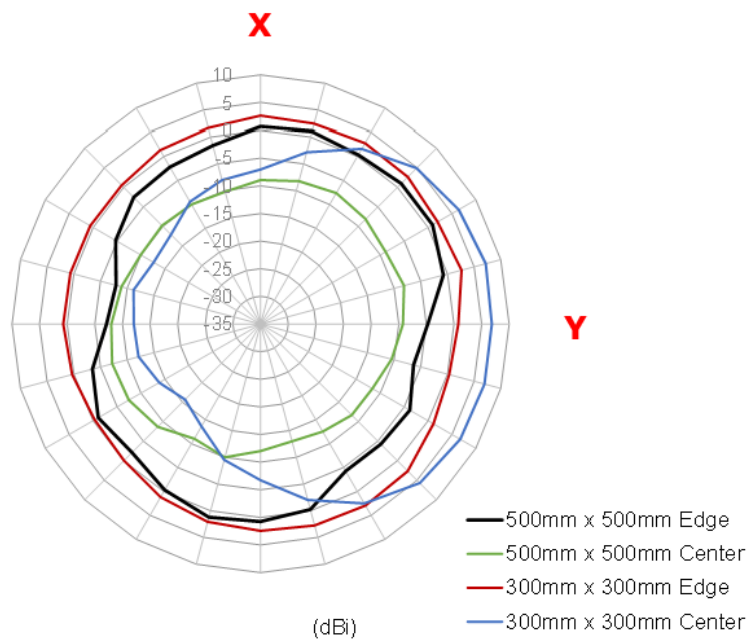
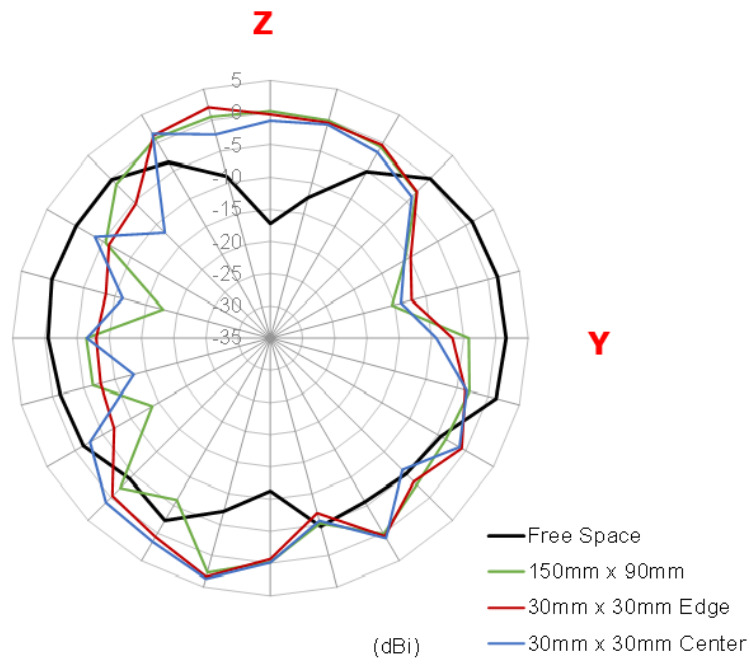

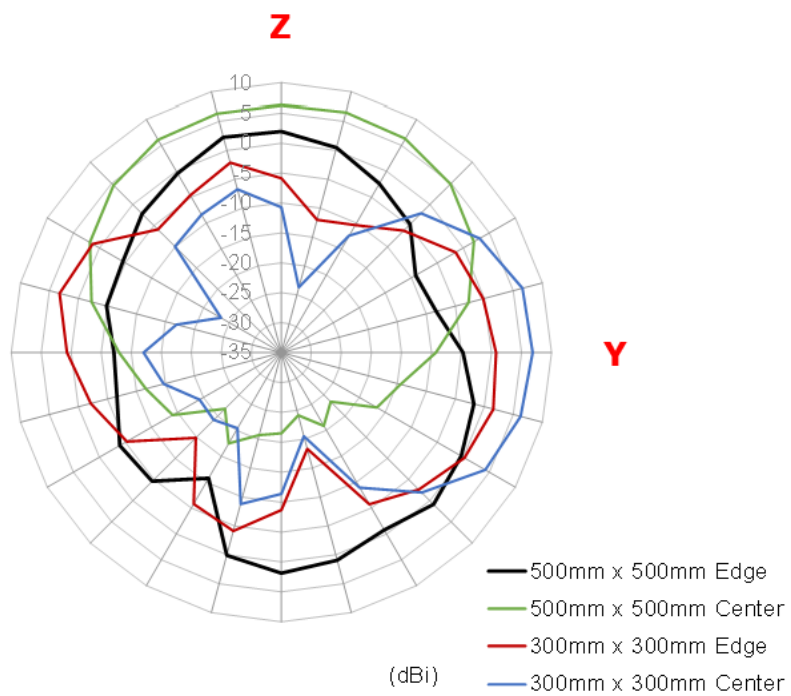
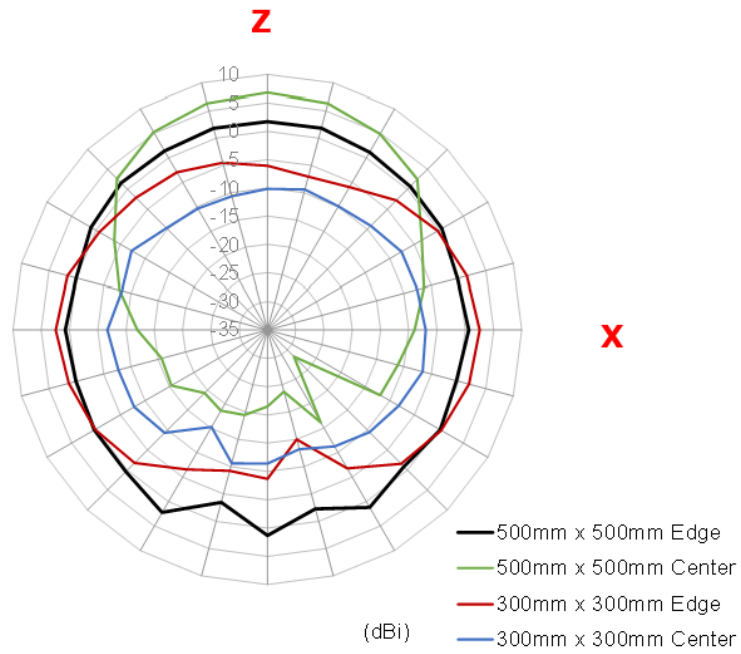



## 7. 3D Radiation Pattern

### 7.1 Free Space - Straight

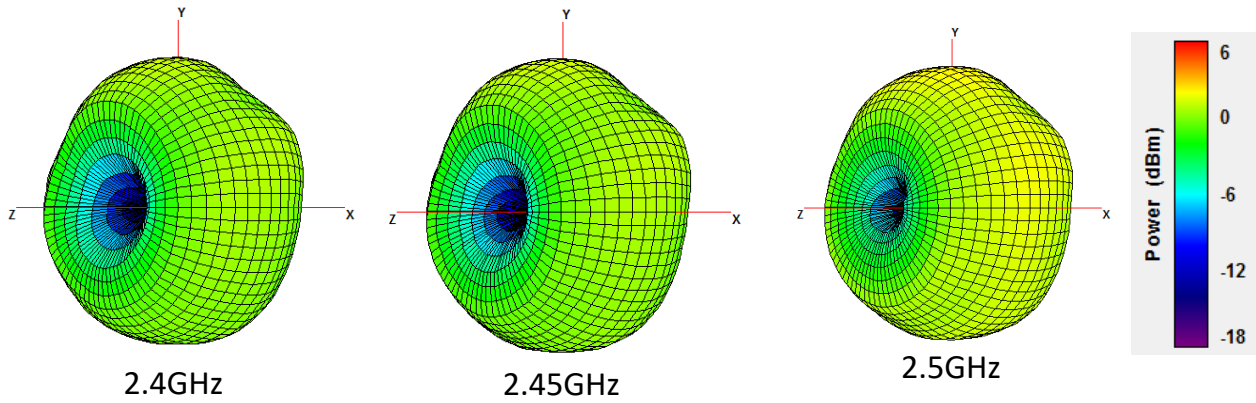

### 7.2 Free Space 90° Bend

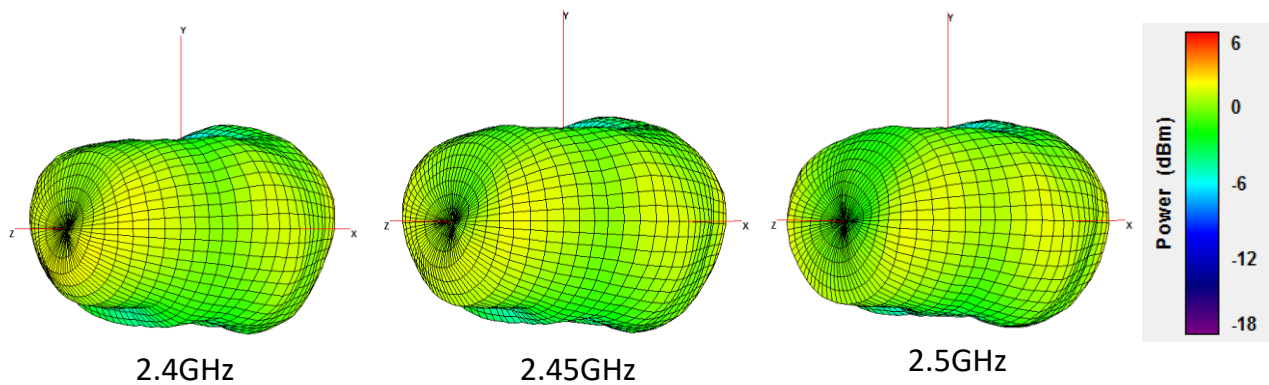

### 7.3 150mm x 90mm Ground Plane Straight

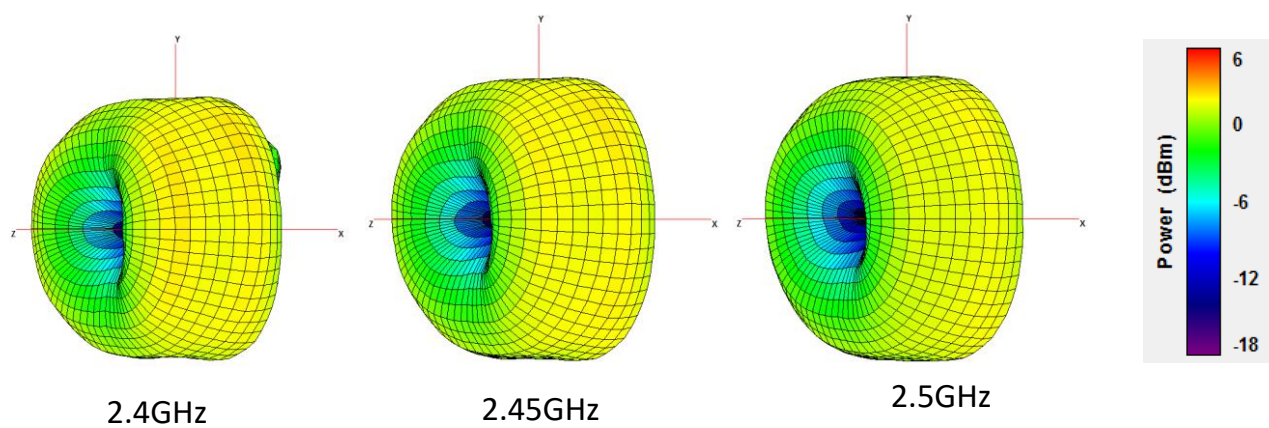

### 7.4 150mm x 90mm Ground Plane 90° Bend

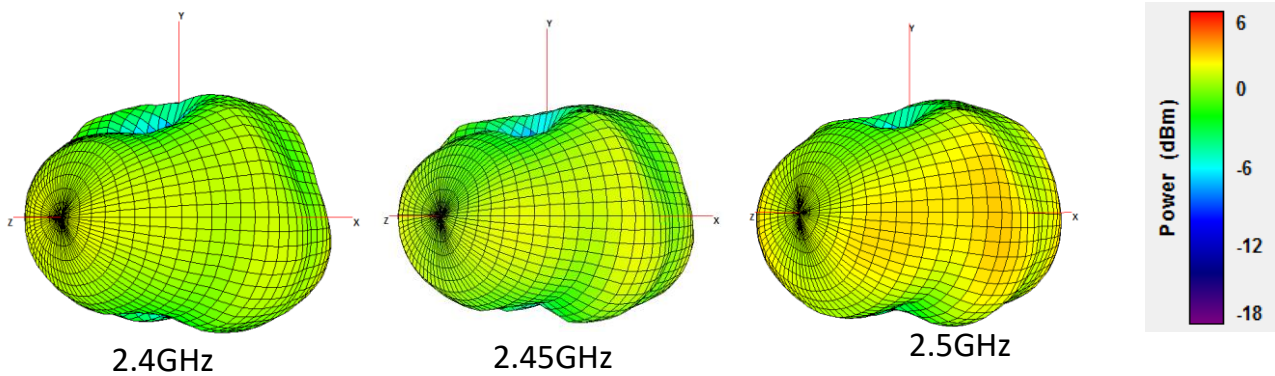

### 7.5 30mm x 30mm Ground Plane Straight Edge Mount

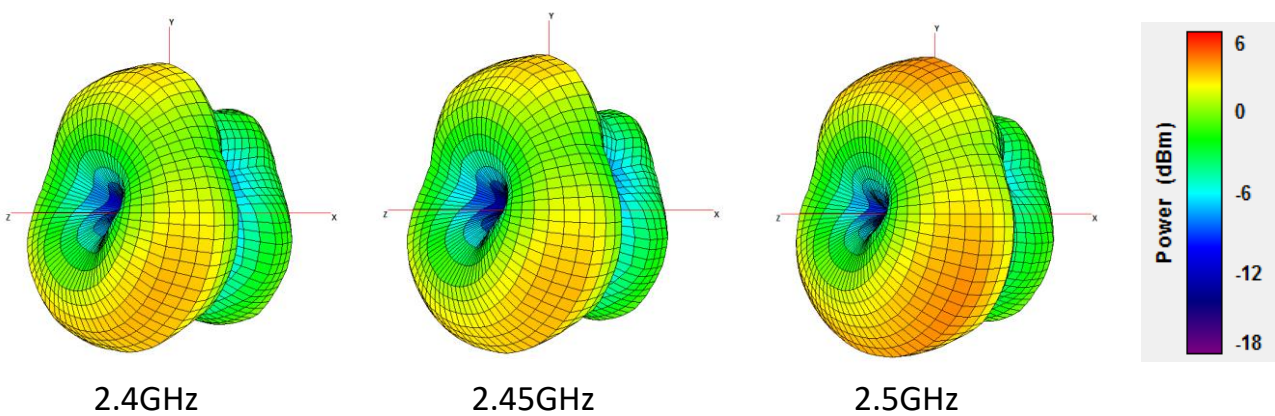

### 7.6 30mm x 30mm Ground Plane 90° Bend Edge Mount

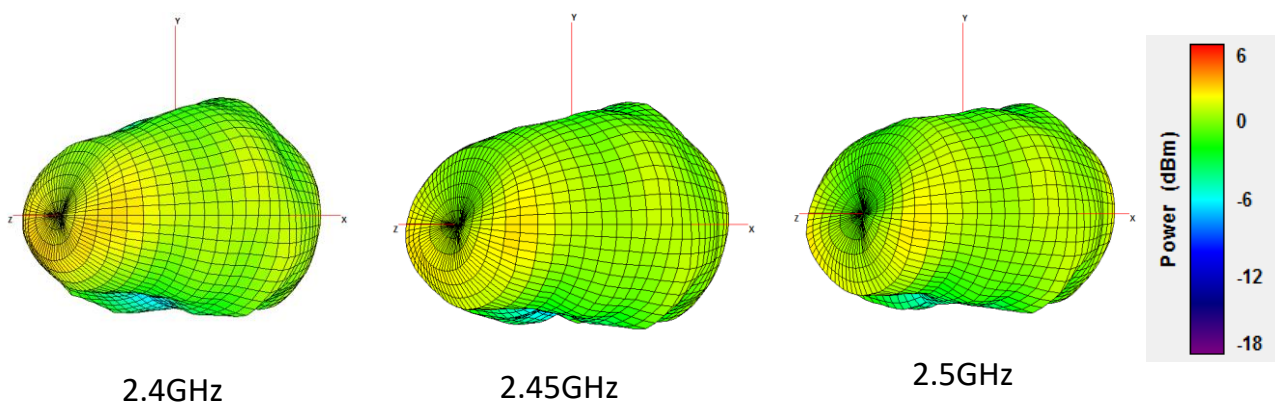

### 7.7 30mm x 30mm Ground Plane Straight Center Mount

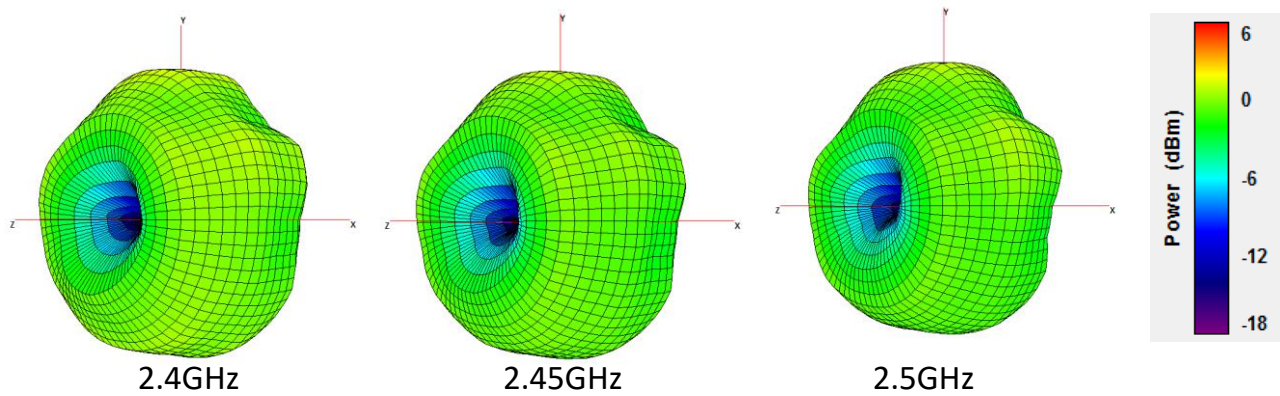

### 7.8 30mm x 30mm Ground Plane 90° Bend Center Mount

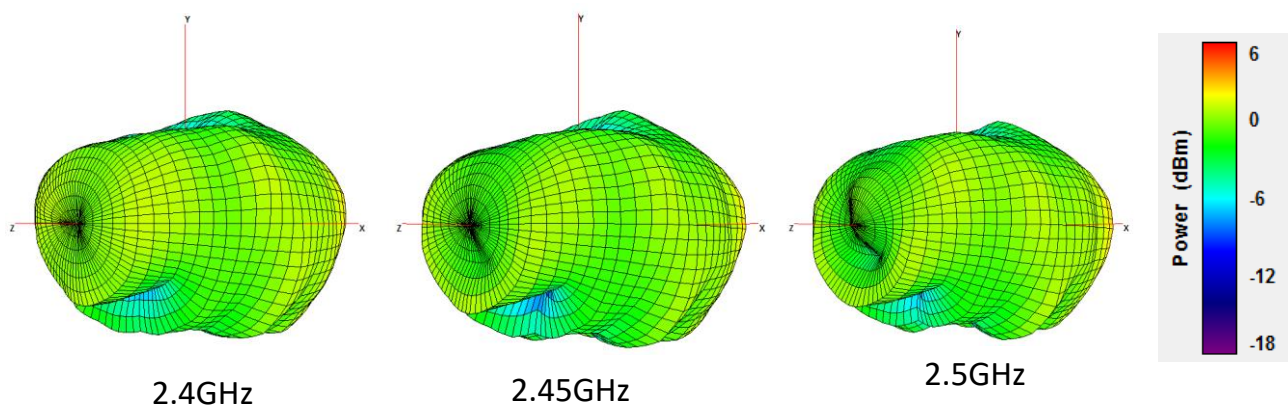

### 7.9 300mm x 300mm Ground Plane Straight Edge Mount

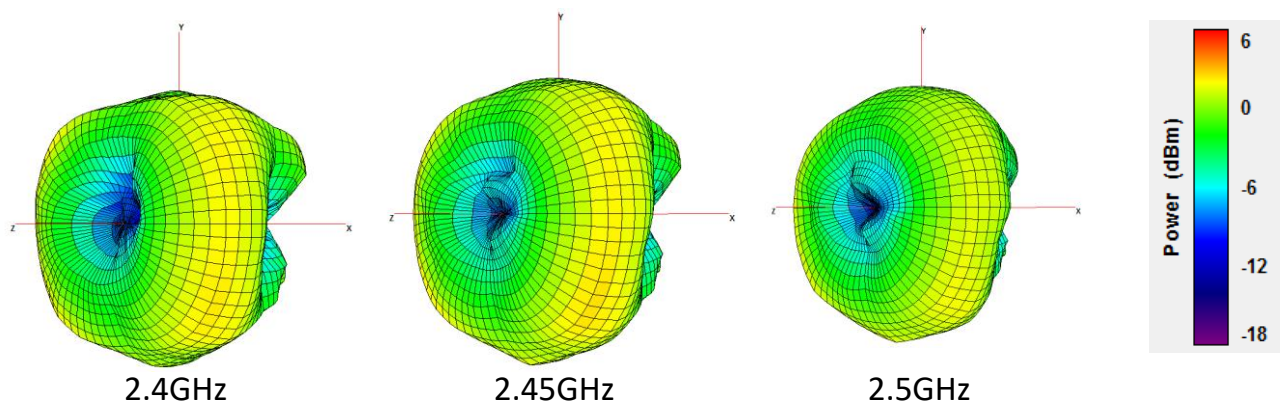

**7.10** 300mm x 300mm Ground Plane 90° Bend Edge Mount

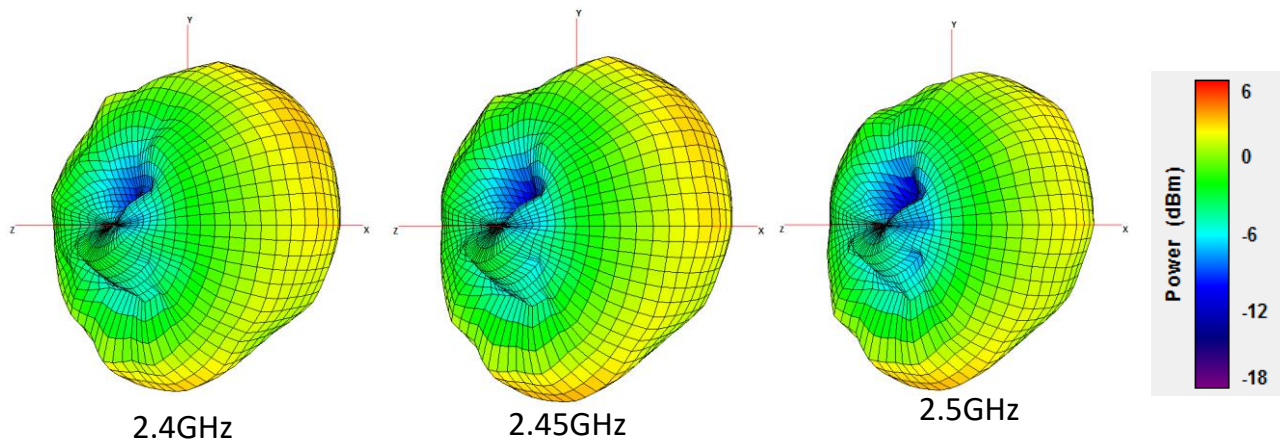

**7.11** 300mm x 300mm Ground Plane Straight Center Mount

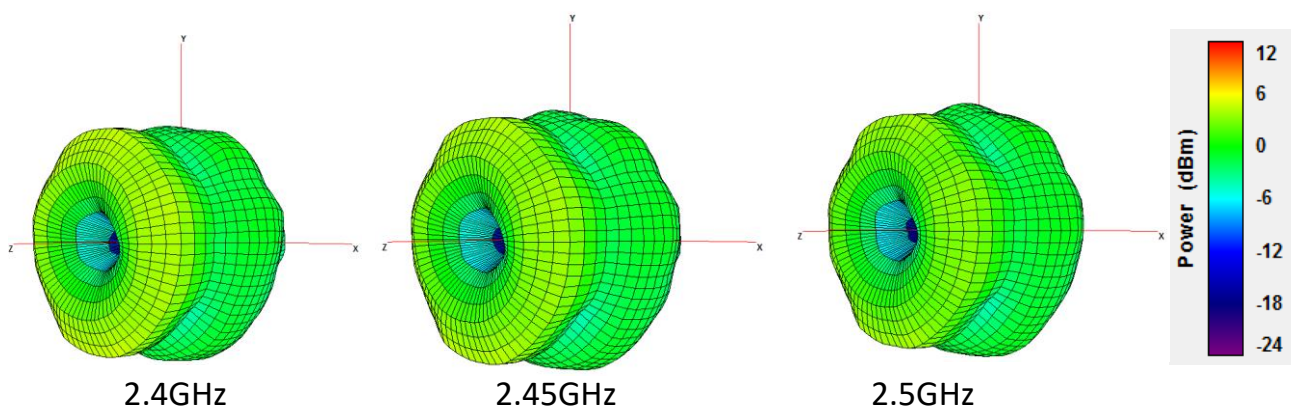

**7.12** 300mm x 300mm Ground Plane 90° Bend Center Mount

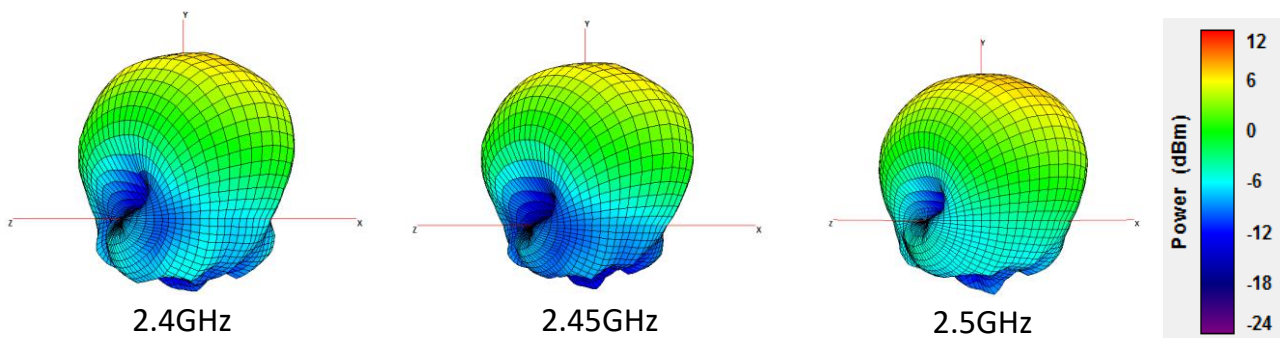

**7.13** 500mm x 500mm Ground Plane Straight Center Mount

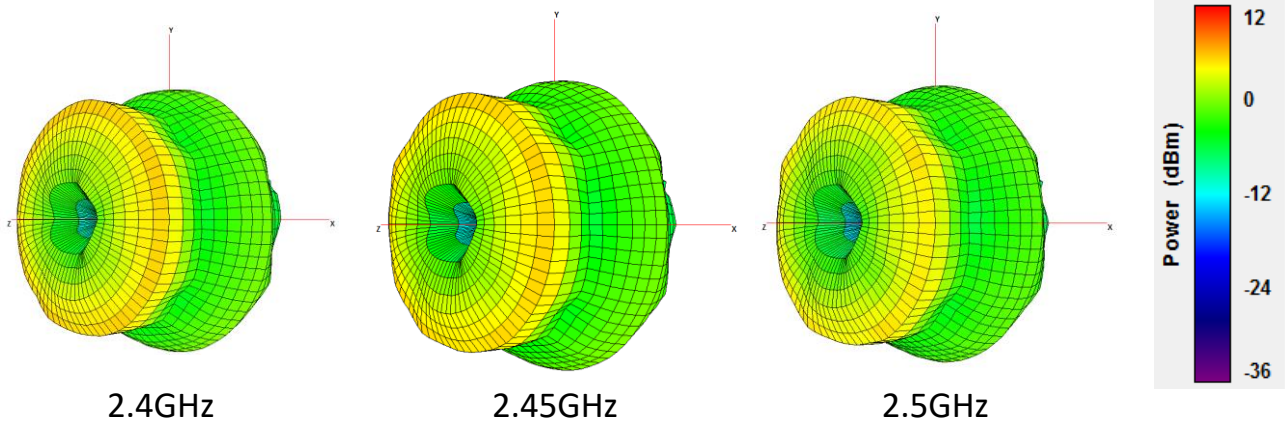

**7.14** 500mm x 500mm Ground Plane 90° Bend Center Mount

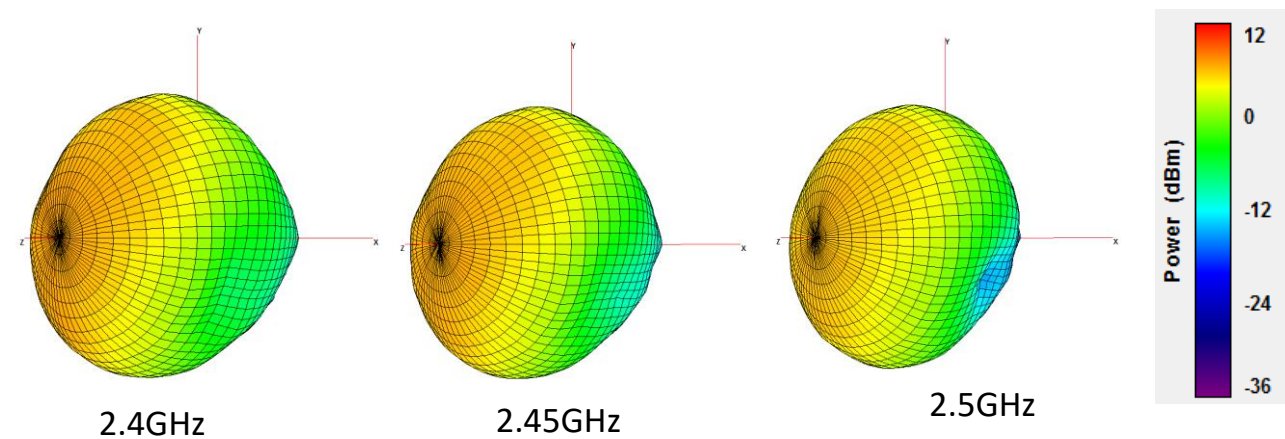

**7.15** 500mm x 500mm Ground Plane Straight Center Mount

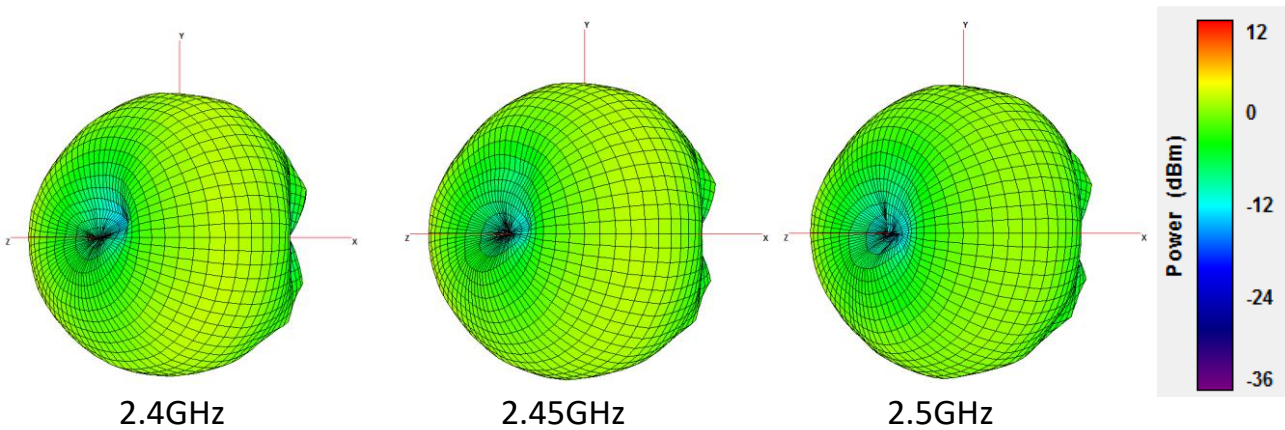

7.16 500mm x 500mm Ground Plane 90° Bend Edge Mount

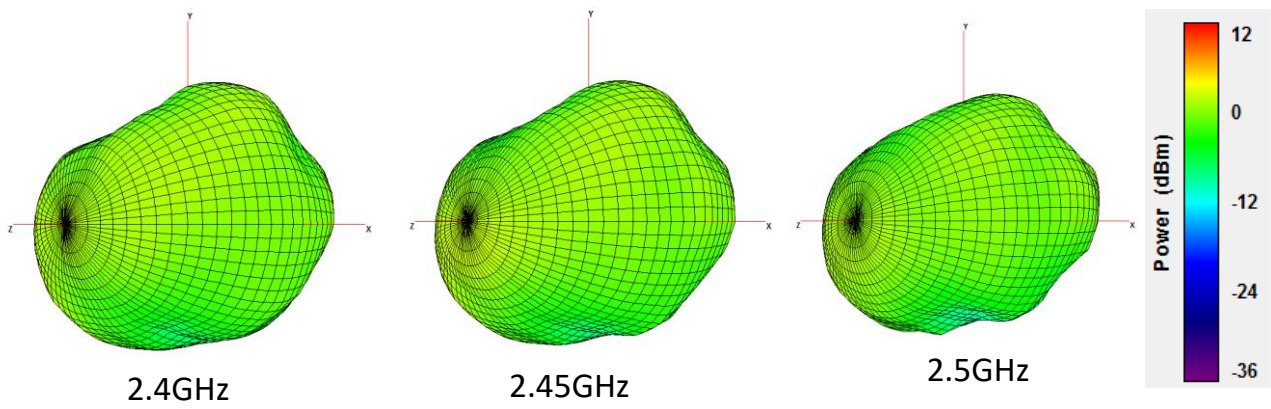

# 8. Mechanical Drawing (Units: mm)

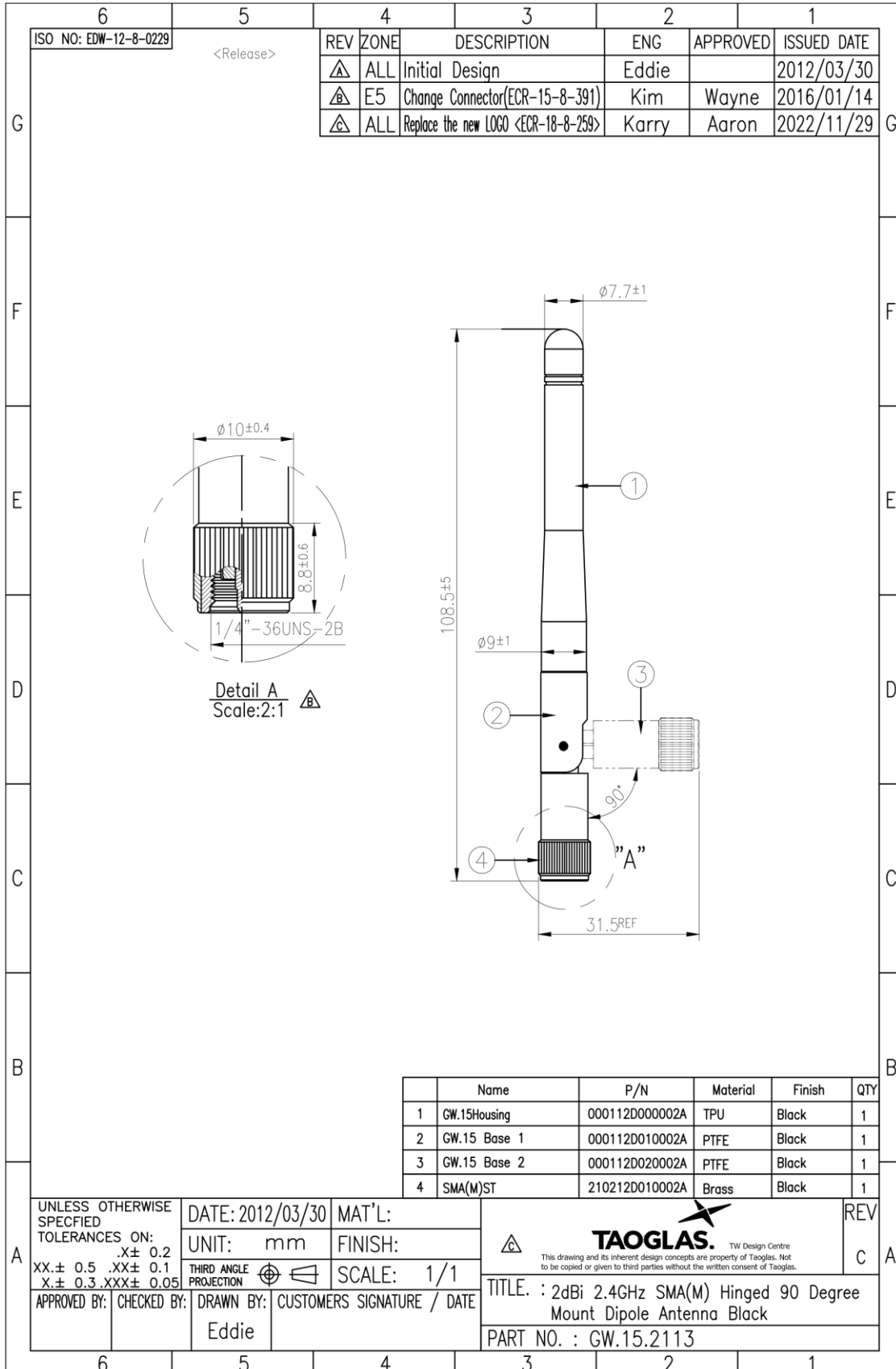

## 9. Packaging

### GW.15.2113 Packaging Specifications

10 pcs GW.15.2113 per PE bag  
PE Bag Dimensions - 100\*160mm  
Weight - 81g

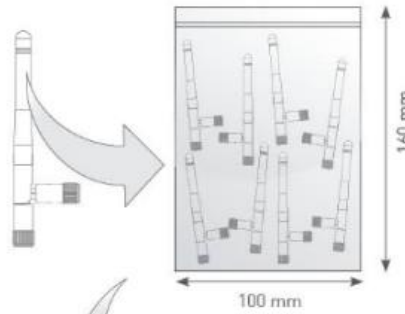

100 PE bags per large PE bag  
100 pcs GW.15.2113 per large PE bags  
Large PE bag Dimensions - 180\*280mm  
Weight - .82kg

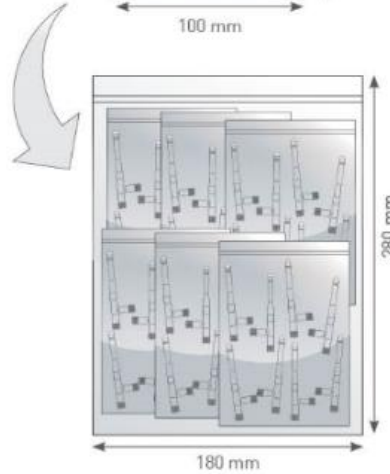

10 Large PE bags per carton  
1000 pcs GW.15.2113 per carton  
Carton Dimensions - 360\*310\*160mm  
Weight - 8.2kg

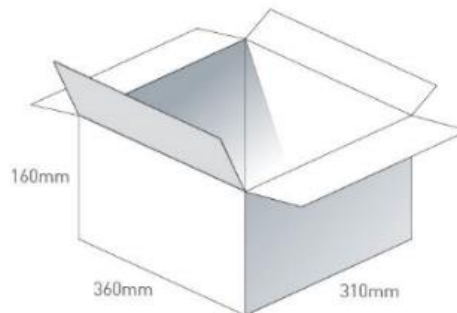

Pallet Dimensions 1200\*1000\*1430mm  
63 Cartons per Pallet  
12 Cartons per layer  
6 Layers

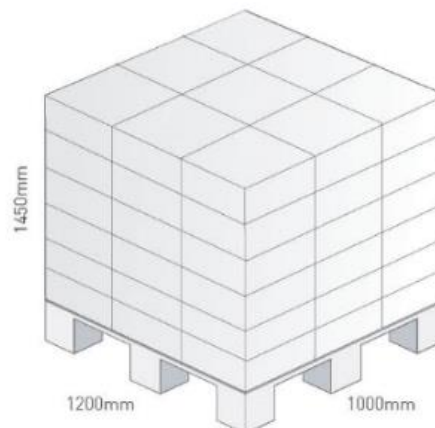



Changelog for the datasheet

**SPE-11-8-134- GW.15.2113**

<b>Revision: H</b>	
Date:	2024-11-24
Changes:	Updated specifications
Changes Made by:	Cesar Sousa

**Previous Revisions**

<b>Revision: G</b>	
Date:	2018-12-14
Changes:	Updated Gain
Changes Made by:	Jack Conroy

<b>Revision: B</b>	
Date:	2014-06-06
Changes:	updated IP65
Changes Made by:	Aine Doyle

<b>Revision: F</b>	
Date:	2018-05-10
Changes:	Update Specifications
Changes Made by:	Peter Monahan

<b>Revision: A (Original First Release)</b>	
Date:	2013-04-25
Notes:	First Release
Author:	Aine Doyle

<b>Revision: E</b>	
Date:	2016-04-26
Changes:	Amended connector
Changes Made by:	Aine Doyle

<b>Revision: D</b>	
Date:	2015-08-27
Changes:	Added note on Gain.
Changes Made by:	Aine Doyle

<b>Revision: C</b>	
Date:	2015-02-18
Changes:	added note on Gain
Changes Made by:	Aine Doyle



**TAOGLAS**®

