

| | | | | |
|--|----------|--|----------|----------|
| PROPRIETARY INFORMATION: PROPRIETARY OF GLOBTEK, INC. ANY REPRODUCTION, DISCLOSURE OR USE OF THIS DRAWING, IN WHOLE OR IN PART, IS HEREBY PROHIBITED EXCEPT AS SPECIFIED IN WRITING BY GLOBTEK, INC. | REVISION | | | |
| | REV | DESCRIPTION | DATE | APPROVED |
| | A | INITIAL RELEASE, RFS. 16437, EM | 06/16/09 | HM |
| | B | UPDATE I/P, O/P CONNECTORS, PACKING, LED, RFS. 16938, MS | 08/24/09 | HM |
| | C | CHANGE LABEL SIZE, RFS.17516, EM | 11/17/09 | HM |



All models under this series are Certified to be in compliance with all the applicable requirements of UL60601-1 2nd Edition, CSA 22.2 No.601.1-M90 and EN 60601-1:A2. Globtek's Medical power supplies are designed to be used in applications that do not connect the output to Patient Circuits directly. The power supply can be used in systems with patient applied parts only when appropriate system level isolation is provided by the end user.
 For Medical units used in the US and Canada, a UL/CSA approved hospital grade AC cord of type SV or better (AWG18 or bigger) shall be used (ie. Globtek PN: 1191068F0701). This is required to comply with the relevant standards and ensure proper grounding reliability.

1. NOTES:

DIMENSIONS ARE IN MM UNLESS SPECIFIED OTHERWISE.



2. ELECTRICAL SPECIFICATIONS:

INPUT VOLTAGE: 100-240 VAC
 INPUT CURRENT: < 0.6 A RMS MAX
 INPUT FREQUENCY: 47 - 63 HZ
 OUTPUT VOLTAGE: 24 VDC, NO MINIMUM LOAD REQUIRED
 OUTPUT CURRENT: 1.04A
 OUTPUT POWER: 25 WATTS, MAXIMUM

MEASURED AT 20 MHz BANDWIDTH WITH 0.1µf CERAMIC CAPACITOR IN PARALLEL WITH 10 µf ELECTROLYTIC CAPACITOR CONNECTED AT THE END OF THE OUTPUT CONNECTOR.

OUTPUT REGULATION: ± 5 % OF NOMINAL OUTPUT VOLTAGE,
 MEASURED AT O/P CONNECTOR AT NOMINAL LINE

LINE REGULATION: ± 1 % MAX AT FULL LOAD

TURN ON/ TURN OFF OVERSHOOT: 5% MAX 500µs MAX RECOVERY TIME FOR 25% TO 50% STEP LOAD

TURN-ON DELAY: 3000 mSEC MAX AT FULL LOAD, 115 VAC

HOLD-UP TIME: 10 mSEC MIN AT NOMINAL INPUT AND FULL LOAD

INRUSH CURRENT: 30 A MAX AT COLD START 120 VAC, 60A MAX COLD START 230VAC

SWITCHING FREQUENCY: 66.5 KHz TYPICAL

OVER-VOLTAGE PROTECTION: PROTECTED, HICCUP WITH AUTO RECOVERY

OVER-LOAD: PROTECTED, HICCUP WITH AUTO RECOVERY

SHORT CIRCUIT: PROTECTED, HICCUP WITH AUTO RECOVERY

EFFICIENCY: 80% TYPICAL AT NOMINAL LINE

NO LOAD POWER CONSUMPTION: MEETS ENERGY STAR LEVEL IV, 115 VAC

| | | | | | |
|--|-------------------------|----------------|---|-------------|--|
| Foot Note: Globtek Inc. will not be liable for the safety and performance of these power supplies if unauthorized access and repair occurs. End user should consult applicable UL, CSA or EN standards for proper installation instructions | DASH NO. | PART NO | REV. | DESCRIPTION | NOTES |
| | TABULATION BLOCK | | | | |
| Limitation of Use: Globtek product are not authorized for use as mission critical components in life support, hazardous environment, nuclear or aircraft applications without prior written approval from the CEO of Globtek Inc. | | | TOLERANCES: DECIMALS ANGULAR .xx +/- 0.1 +/- 1° .xxx +/- .005 | | 186 Veterans Dr. Northvale, NJ 07647 Tel. 201-784-1000 Fax 201.784.0111 www.globtek.com |
| | INIT.BY: EM | DATE: 06/15/09 | MILLIMETERS ANGULAR .xx +/- 0.3 +/- 1° .xxx +/- .013 | | |
| Contents of this document are subject to change without prior notice | DRAWN: NF | DATE: 06/15/09 | FSCN No.: G, N | SIZE A | MODEL NO: GTM41060-2524-FW REV. C |
| | APRVD :HM | DATE: 06/15/09 | CAGE CODE: 0GV V90 SCALE: NONE | | PART NO: GTM410602524FWIM(RE) SHEET 1 OF 5 |

PROPRIETARY INFORMATION:

PROPRIETARY OF GLOBTEK, INC. ANY REPRODUCTION, DISCLOSURE OR USE OF THIS DRAWING, IN WHOLE OR IN PART, IS HEREBY PROHIBITED EXCEPT AS SPECIFIED IN WRITING BY GLOBTEK, INC.

OUTPUT RIPPLE VOLTAGE (PEAK TO PEAK): +/-1% OR 50 mV WHICHEVER IS GREATER AT NOMINAL OUTPUT VOLTAGE.

OTHER PROTECTION: INPUT LINE AND NEUTRAL FUSING
SAFETY APPROVALS : UL60601-1, CUL TO 22.2 # 601, DEMKO TO EN60601-1,
UL60950-1, CUL TO 22.2 # 950, DEMKO TO EN60950-1, CE, CB REPORT
DIELECTRIC WITHSTAND VOLTAGE: 5656 VDC PRIMARY-SECONDARY
LEAKAGE CURRENT: ≤ 0.3 mA AT 240 VAC
EMI: COMPLIES WITH EN55011 AND EN55022 CLASS B AND
FCC PART 15 CLASS B WHEN TESTED WITH A RESISTIVE
LOAD, BOTH CONDUCTED AND RADIATED EMI
CE MARK: TESTED TO COMPLY WITH EN 60601-1-2:2001, EN61000-3-2 ,
EN61000-3-3, INCLUDING EN61000-4-2, EN61000-4-3,
EN61000-4-4, EN61000-4-5, EN61000-4-6, EN61000-4-8, EN61000-4-11
EFFICIENCY: COMPLIES TO SECTION 301 OF ENERGY INDEPENDENCE AND SECURITY ACT (EISA)
COMPLIES WITH ENERGY STAR TIER 2 (NORTH AMERICA),
CECP TIER 2 (CHINA), MEPS TIER 2 (AUSTRALIA), CODE OF CONDUCT (EUROPE)
MTBF: 200,000 HOURS AT 25°C AMBIENT TEMPERATURE
OPERATING TEMPERATURE: 0°C TO 40° C
STORAGE TEMPERATURE: -40°C TO 80° C
HUMIDITY: 0% TO 90% RELATIVE HUMIDITY
ROHS: COMPLIES WITH EU 2002/95/EC AND CHINA SJ/T 11363-2006

OUTPUT DERATING CURVE

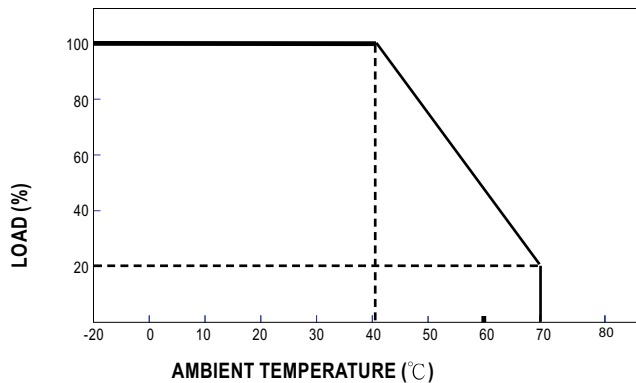

GlobTek, Inc.
www.globtek.com

186 Veterans Dr. Northvale, NJ 07647
Tel. 201-784-1000 Fax 201.784.0111

DWG TITLE: OPEN FRAME SWITCHING POWER SUPPLY, 25 WATTS,
24V@1.04A , UNIVERSAL INPUT, ITE/MEDICAL, CLASS II

MODEL NO: GTM41060-2524-FW

REV. C

PART NO: GTM410602524FWIM(RE)

SHEET 2 OF 5

PROPRIETARY INFORMATION:
 PROPRIETARY OF GLOBTEK, INC. ANY REPRODUCTION, DISCLOSURE OR USE OF THIS DRAWING, IN WHOLE OR IN PART, IS HEREBY PROHIBITED EXCEPT AS SPECIFIED IN WRITING BY GLOBTEK, INC.

3. MECHANICAL:

SIZE: 98 x 50 x 28 ± 0.5 mm

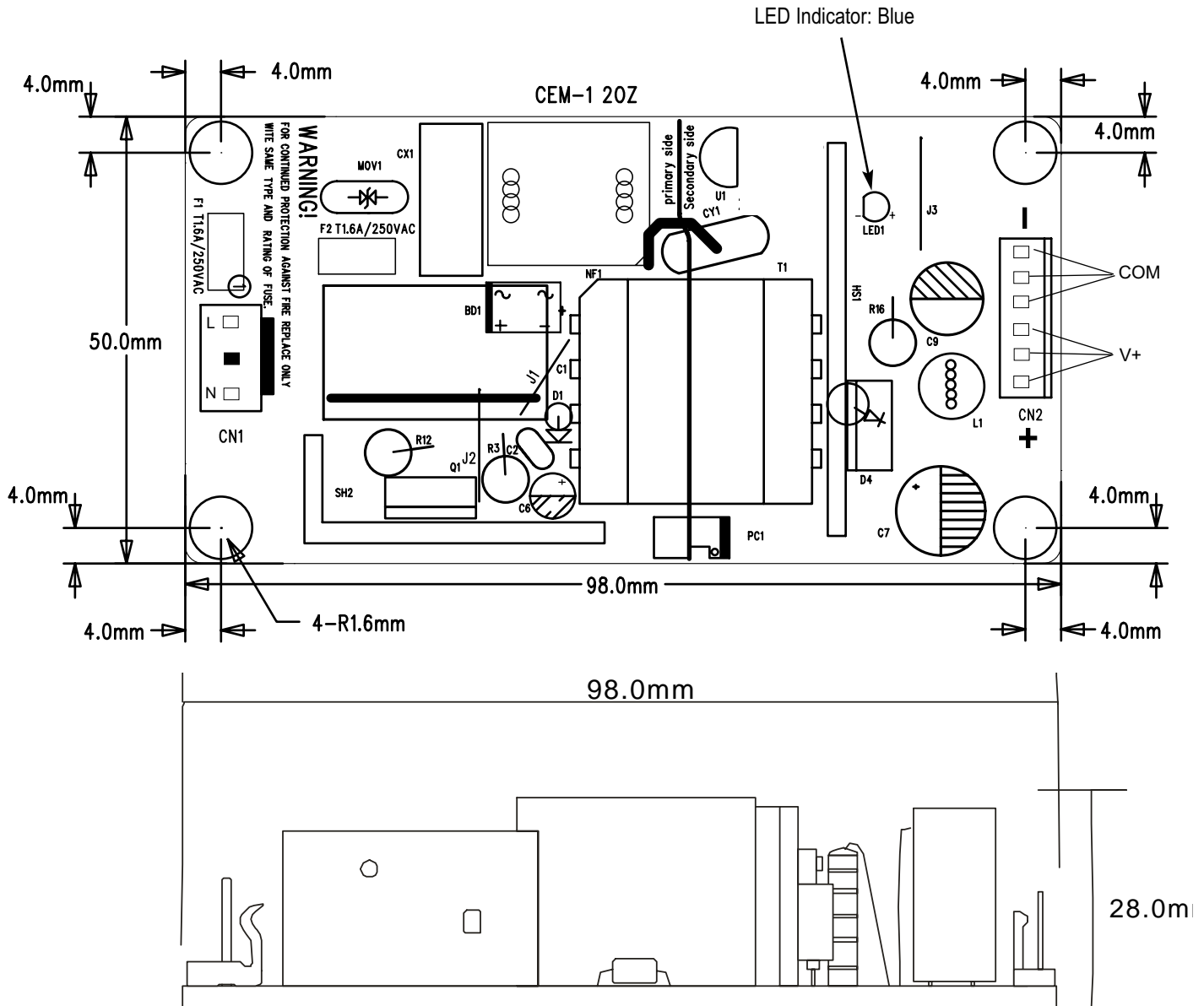

4. INPUT CONNECTOR:

MOLEX 09-65-2038 OR EQUIVALENT, 3 CIRCUITS WITH PIN 2 REMOVED

5. OUTPUT CONNECTOR:

MOLEX 22-28-0040 OR EQUIVALENT, 6 CIRCUITS CONNECTOR

| | | |
|--|--|--|
|  GlobTek, Inc. www.globtek.com | 186 Veterans Dr. Northvale, NJ 07647 Tel. 201-784-1000 Fax 201.784.0111 | |
| | DWG TITLE: OPEN FRAME SWITCHING POWER SUPPLY, 25 WATTS, 24V@1.04A, UNIVERSAL INPUT, ITE/MEDICAL, CLASS II | |
| MODEL NO: GTM41060-2524-FW | REV. C | |
| PART NO: GTM410602524FWIM(RE) | SHEET 3 OF 5 | |

PROPRIETARY INFORMATION:
 PROPRIETARY OF GLOBTEK, INC. ANY REPRODUCTION, DISCLOSURE OR USE OF THIS DRAWING, IN WHOLE OR IN PART, IS HEREBY PROHIBITED EXCEPT AS SPECIFIED IN WRITING BY GLOBTEK, INC.

6. LABEL:

MATERIAL: .007 (0.18) THICK FLAT THERMAL TRANSFER, IMPRINTABLE, BLACK POLYESTER SHEET WITH WHITE NOMENCLATURE.
 MANUFACTURER: STEVEN LABEL, MATERIAL I.D. NO.3302-33, UL FILE NO. MH12821(N), UL MATERIAL DESIGNATION FILE NO. GHW332RL.
 OPTIONAL LABEL MATERIAL CAN BE SUBSTITUTED PROVIDING MATERIAL IS UL LISTED AND COMPLIES WITH APPLICABLE SAFETY REQUIREMENTS.

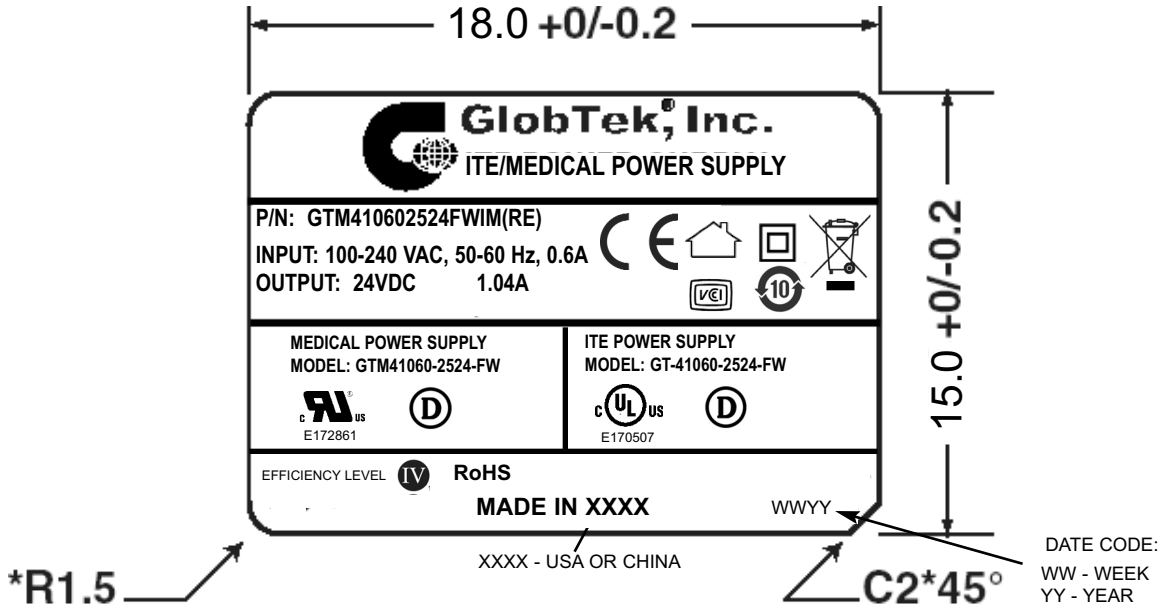

ACTUAL POSITIONING OF SYMBOLS AND TEXT IS SUBJECT TO CHANGE AT TIME OF MANUFACTURE

PS E JQA → AVAILABLE UPON REQUEST

| | | |
|--|--|--|
|  GlobTek, Inc. www.globtek.com | | 186 Veterans Dr. Northvale, NJ 07647 Tel. 201-784-1000 Fax 201.784.0111 |
| DWG TITLE: OPEN FRAME SWITCHING POWER SUPPLY, 25 WATTS, 24V@1.04A, UNIVERSAL INPUT, ITE/MEDICAL, CLASS II | | |
| MODEL NO: GTM41060-2524-FW | | REV. C |
| PART NO: GTM410602524FWIM(RE) | | SHEET 4 OF 5 |

PROPRIETARY INFORMATION:

PROPRIETARY OF GLOBTEK, INC. ANY REPRODUCTION, DISCLOSURE OR USE OF THIS DRAWING, IN WHOLE OR IN PART, IS HEREBY PROHIBITED EXCEPT AS SPECIFIED IN WRITING BY GLOBTEK, INC.

7. PACKING:

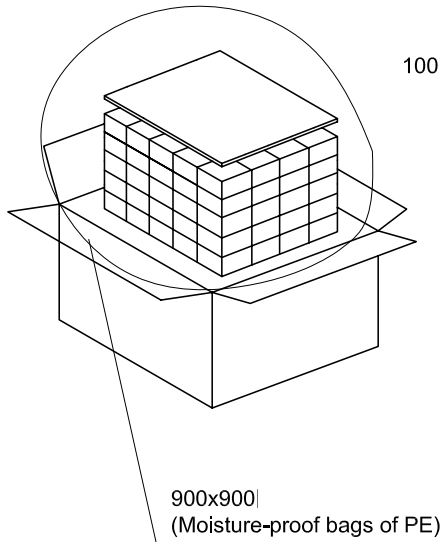

100 PCS/CARTON

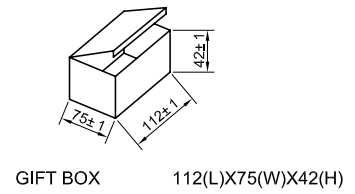
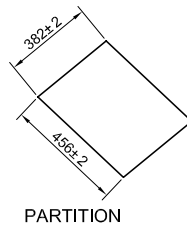
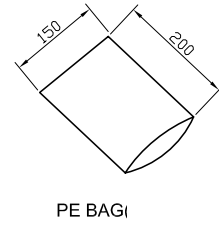
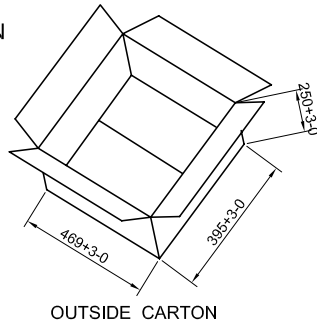

China RoHS SELF DISCLOSURE TABLE

| 有毒有害物质或元素名称及含量标准形式 Name and concentration of hazardous substance or element in product | | | | | | |
|---|--|------|------|------------|----------|------------|
| 零件名 Name of part | 剧毒有害物质或元素 Hazardous substance or element | | | | | |
| | 铅 Pb | 汞 Hg | 镉 Cd | 六价铬 Cr(VI) | 多溴联苯 PBB | 多溴二苯醚 PBDE |
| Diode (DF) 二极管 | X | ○ | ○ | ○ | ○ | ○ |
| Diode (ITO-220AB) 二极管 | X | ○ | ○ | ○ | ○ | ○ |
| SMD resistor SMD 电阻 | X | ○ | ○ | ○ | ○ | ○ |
| SMD Diode SMD 二极管 | X | ○ | ○ | ○ | ○ | ○ |
| PLUG 直流输出端子 | X | ○ | ○ | ○ | ○ | ○ |
| AC PIN 交流输入端子 | X | ○ | ○ | ○ | ○ | ○ |

○: 表示该有毒有害物质在这部件中所有同质材料中的含量均在SJ/T 11363-2006规定的限量要求以下。
○: refers to the concentration of this hazard substance in the all homogenous materials in this part is below the concentration limit as stipulated in the standard SJ/T 11363-2006.

X: 表示该有毒有害物质至少在这部件中的某一同质材料中的含量超出 SJ/T 11363-2006规定的限量要求。
X: refers to the concentration of this hazard substance at least in a homogenous material is higher than the concentration limit as stipulated in the standard SJ/T 11363-2006.

GlobTek, Inc.
www.globtek.com

186 Veterans Dr. Northvale, NJ 07647
Tel. 201-784-1000 Fax 201.784.0111

DWG TITLE: OPEN FRAME SWITCHING POWER SUPPLY, 25 WATTS,
24V@1.04A, UNIVERSAL INPUT, ITE/MEDICAL, CLASS II

MODEL NO: GTM41060-2524-FW

REV. C

PART NO: GTM410602524FWIM(RE)

SHEET 5 OF 5