

SCHOTTKY DIODE MODULE TYPE 240A

Features

High Surge Capability
 Type 60V V_{RRM}
 Isolation Type Package
 Electrically Isolation base plate



Maximum Ratings

Operating Temperature : -40 °C to +150 °C
 Storage Temperature : -40 °C to +150 °C

Part Number	Maximum Recurrent Peak Reverse Voltage	Maximum RMS Voltage	Maximum DC Blocking Voltage
GSXD120A006S1-D3	60V	42V	60V

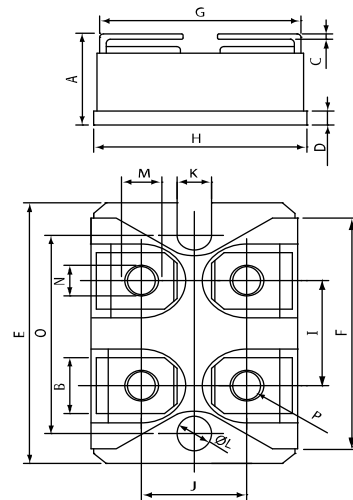

Electrical Characteristics @ 25 °C Unless Otherwise Specified.

Average Forward Current (Per pkg)	$I_{F(AV)}$	240A	$T_c = 110\text{ }^\circ\text{C}$
Peak Forward Surge Current (Per leg)	I_{FSM}	1500A	8.3ms, half sine
Maximum Instantaneous Forward Voltage (Per leg)	V_F	0.70V 0.75V	$I_{FM} = 120\text{A}; T_J = 125\text{ }^\circ\text{C}$ $I_{FM} = 120\text{A}; T_J = 25\text{ }^\circ\text{C}$
Maximum Instantaneous Reverse Current At Rated DC Blocking Voltage (Per leg)	I_R	1 mA 10 mA 30 mA	$T_J = 25\text{ }^\circ\text{C}$ $T_J = 100\text{ }^\circ\text{C}$ $T_J = 150\text{ }^\circ\text{C}$
Isolation Voltage	V_{iso}	2500V	A.C. 1 minute
Maximum Thermal Resistance Junction To Case (Per leg)	$R_{\theta jc}$	0.38°C/W	

NOTE :

(1) Pulse Test: Pulse Width 300 μ sec, Duty < 2%

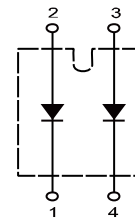

DIM	DIMENSIONS			
	INCHES		MM	
	MIN	MXA	MIN	MXA
A	.500	.519	12.70	13.20
B	.307	.322	7.80	8.20
C	.029	.033	.75	.84
D	.077	.082	1.95	2.10
E	1.487	1.502	37.80	38.20
F	1.250	1.258	31.75	32.00
G	.931	.956	23.65	24.30
H	.996	1.007	25.30	25.60
I	.586	.594	14.90	15.10
J	.492	.516	12.50	13.10
K	.161	.169	4.10	4.30
L	.161	.169	4.10	4.30
M	.181	.191	4.60	4.95
N	.165	.177	4.20	4.50
O	1.184	1.192	30.10	30.30
P	M4*8			

Figure.1 - Typical Forward Characteristics

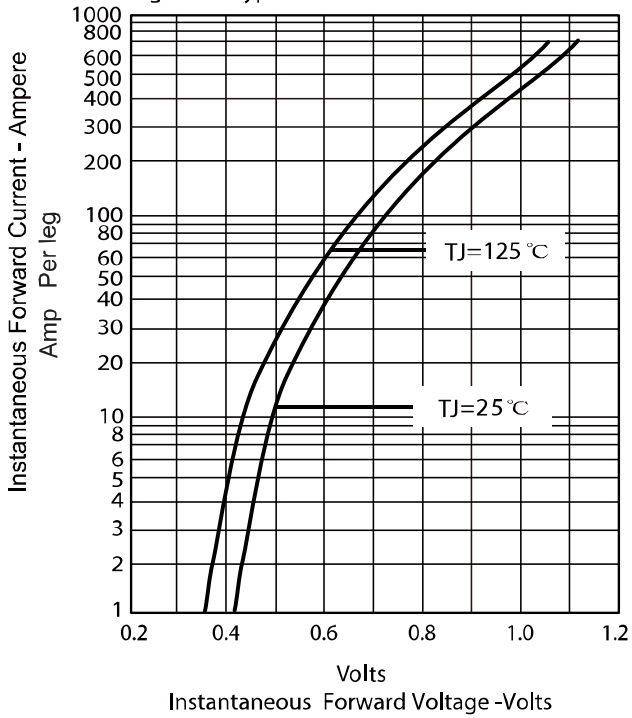

Figure .2- Forward Derating Curve

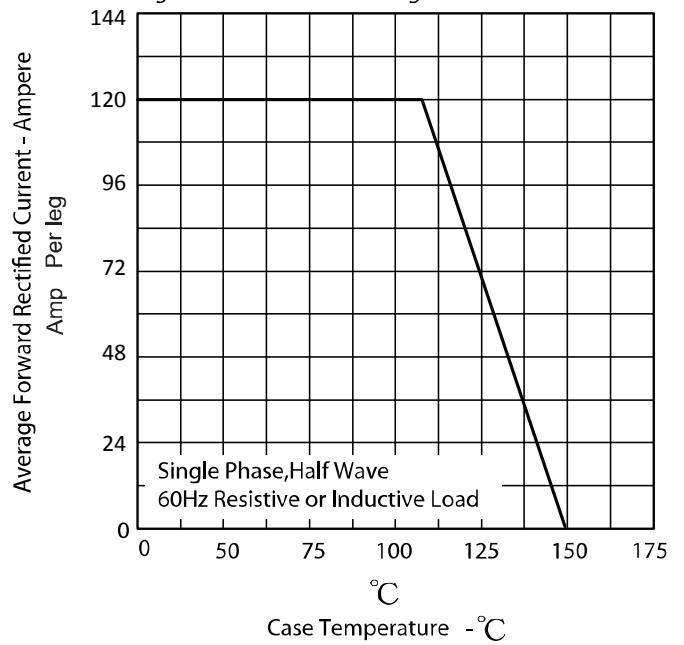

Figure.3 - Peak Forward Surge Current

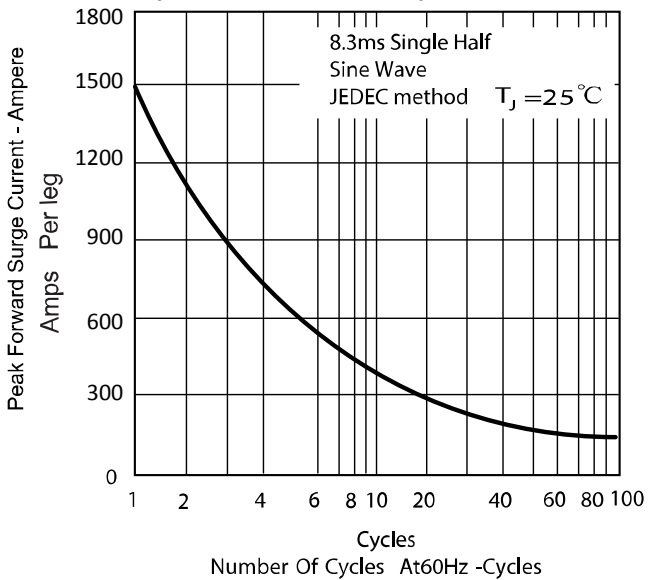
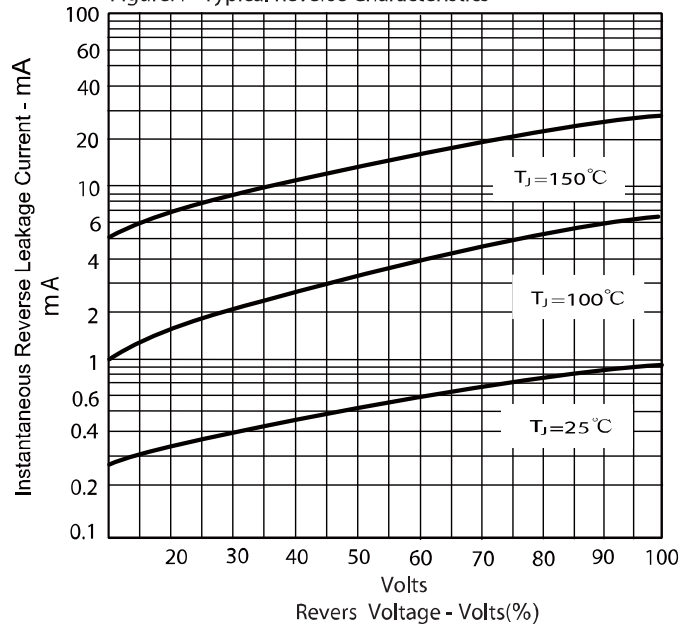

Figure.4 - Typical Reverse Characteristics



Revision History

Date	Revision	Notes
8/10/2014	1.0	Initial release
01/03/2020	1.1	Applied company name change

Notes

RoHS Compliance

The levels of RoHS restricted materials in this product are below the maximum concentration values (also referred to as the threshold limits) permitted for such substances, or are used in an exempted application, in accordance with EU Directive 2011/65/EC (RoHS2), as implemented March, 2013. RoHS Declarations for this product can be obtained from the Product Documentation sections of www.SemiQ.com.

REACH Compliance

REACH substances of high concern (SVHC) information is available for this product. Since the European Chemicals Agency (ECHA) has published notice of their intent to frequently revise the SVHC listing for the foreseeable future, please contact our office at SemiQ Headquarters in Lake Forest, California to insure you get the most up-to-date REACH SVHC Declaration. REACH banned substance information (REACH Article 67) is also available upon request.

SemiQ Inc., reserves the right to make changes to the product specifications and data in this document without notice. SemiQ products are sold pursuant to SemiQ's terms and conditions of sale in place at the time of order acknowledgement.

This product has not been designed or tested for use in, and is not intended for use in, applications implanted into the human body nor in applications in which failure of the product could lead to death, personal injury or property damage, including but not limited to equipment used in the operation of nuclear facilities, life-support machines, cardiac defibrillators or similar emergency medical equipment, aircraft navigation or communication or control systems, or air traffic control.

SemiQ makes no warranty, representation or guarantee regarding the suitability of its products for any particular purpose, nor does SemiQ assume any liability arising out of the application or use of any product or circuit, and specifically disclaims any and all liability, including without limitation special, consequential or incidental damages. Buyer is responsible for its products and applications using SemiQ products.

To obtain additional technical information or to place an order for this product, please contact us. The information in this datasheet is provided by SemiQ. SemiQ reserves the right to make changes, corrections, modifications, and improvements of datasheet without notice.