

Main Product Characteristics

Polarity	N-Ch	P-Ch
V_{DSS}	40V	-40V
$R_{DSon(max.)}$	32m Ω	40m Ω
I_D	6.7A	-7.2A

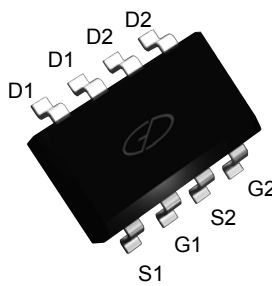

SOP-8

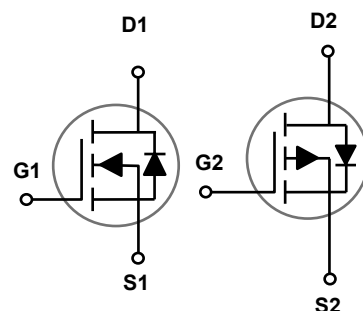

Schematic Diagram

Features and Benefits

- Advanced MOSFET process technology
- Ideal for high efficiency switched mode power supplies
- Low on-resistance with low gate charge
- Fast switching and reverse body recovery



Description

The GSFQ4701 utilizes the latest techniques to achieve high cell density and low on-resistance. These features make this device extremely efficient and reliable for use in high efficiency switch mode power supply and a wide variety of other applications.

Absolute Maximum Ratings ($T_C=25^\circ\text{C}$ unless otherwise specified)

Parameter	Symbol	Rating		Unit
Drain-Source Voltage	V_{DS}	40	-40	V
Gate-Source Voltage	V_{GS}	± 20	± 20	V
Drain Current – Continuous ($T_C=25^\circ\text{C}$)	I_D	6.7	-7.2	A
Drain Current – Continuous ($T_C=100^\circ\text{C}$)		4.3	-4.5	A
Drain Current – Pulsed ¹	I_{DM}	26.8	28.8	A
Power Dissipation ($T_C=25^\circ\text{C}$)	P_D	2.5		W
Power Dissipation – Derate above 25°C		0.02		W/ $^\circ\text{C}$
Storage Temperature Range	T_{STG}	-55 to +150		$^\circ\text{C}$
Operating Junction Temperature Range	T_J	-55 to +150		$^\circ\text{C}$

Thermal Characteristics

Parameter	Symbol	Typ.	Max.	Unit
Thermal Resistance Junction to Case	$R_{\theta JC}$	---	50	$^\circ\text{C}/\text{W}$
Thermal Resistance Junction to Ambient	$R_{\theta JA}$	---	62	$^\circ\text{C}/\text{W}$

N-Channel Electrical Characteristics ($T_J=25^\circ\text{C}$ unless otherwise specified)

Parameter	Symbol	Conditions	Min.	Typ.	Max.	Unit
Off Characteristics						
Drain-Source Breakdown Voltage	BV_{DSS}	$V_{GS}=0V, I_D=250\mu A$	40	---	---	V
BV_{DSS} Temperature Coefficient	$\Delta BV_{DSS}/\Delta T_J$	Reference to 25°C , $I_D=1\text{mA}$	---	0.04	---	$V/^\circ\text{C}$
Drain-Source Leakage Current	I_{DSS}	$V_{DS}=40V, V_{GS}=0V, T_J=25^\circ\text{C}$	---	---	1	μA
		$V_{DS}=32V, V_{GS}=0V, T_J=125^\circ\text{C}$	---	---	10	μA
Gate-Source Leakage Current	I_{GSS}	$V_{GS}=\pm 20V, V_{DS}=0V$	---	---	± 100	nA
On Characteristics						
Static Drain-Source On-Resistance	$R_{DS(ON)}$	$V_{GS}=10V, I_D=5A$	---	24	32	m Ω
		$V_{GS}=4.5V, I_D=3A$	---	32	45	m Ω
Gate Threshold Voltage	$V_{GS(th)}$	$V_{GS}=V_{DS}, I_D=250\mu A$	1	1.8	2.5	V
$V_{GS(th)}$ Temperature Coefficient	$\Delta V_{GS(th)}$		---	-3	---	$\text{mV}/^\circ\text{C}$
Forward Transconductance	g_{fs}	$V_{DS}=10V, I_D=3A$	---	3.6	---	S
Dynamic and Switching Characteristics						
Total Gate Charge ^{2, 3}	Q_g	$V_{DS}=20V, V_{GS}=4.5V, I_D=3A$	---	2.8	5.6	nC
Gate-Source Charge ^{2, 3}	Q_{gs}		---	0.5	1	
Gate-Drain Charge ^{2, 3}	Q_{gd}		---	1.5	3	
Turn-On Delay Time ^{2, 3}	$T_{d(on)}$	$V_{DD}=20V, V_{GS}=4.5V, R_G=25\Omega, I_D=1A$	---	3.2	6	nS
Rise Time ^{2, 3}	T_r		---	8.6	16	
Turn-Off Delay Time ^{2, 3}	$T_{d(off)}$		---	18	36	
Fall Time ^{2, 3}	T_f		---	6	12	
Input Capacitance	C_{iss}	$V_{DS}=15V, V_{GS}=0V, F=1\text{MHz}$	---	420	800	pF
Output Capacitance	C_{oss}		---	65	120	
Reverse Transfer Capacitance	C_{rss}		---	40	80	
Drain-Source Diode Characteristics and Maximum Ratings						
Continuous Source Current	I_S	$V_G=V_D=0V$, Force Current	---	---	6.7	A
Pulsed Source Current	I_{SM}		---	---	13.4	A
Diode Forward Voltage	V_{SD}	$V_{GS}=0V, I_S=1A, T_J=25^\circ\text{C}$	---	---	1	V

Note:

1. Repetitive Rating: Pulsed width limited by maximum junction temperature.
2. The data tested by pulsed, pulse width $\leq 300 \mu\text{s}$, duty cycle $\leq 2\%$.
3. Essentially independent of operating temperature.

P-Channel Electrical Characteristics ($T_J=25^\circ\text{C}$ unless otherwise specified)

Parameter	Symbol	Conditions	Min.	Typ.	Max.	Unit
Off Characteristics						
Drain-Source Breakdown Voltage	BV_{DSS}	$V_{GS}=0V, I_D=-250\mu A$	-40	---	---	V
BV_{DSS} Temperature Coefficient	$\Delta BV_{DSS}/\Delta T_J$	Reference to 25°C , $I_D=-1\text{mA}$	---	-0.04	---	$V/^\circ\text{C}$
Drain-Source Leakage Current	I_{DSS}	$V_{DS}=-40V, V_{GS}=0V, T_J=25^\circ\text{C}$	---	---	-1	μA
		$V_{DS}=-32V, V_{GS}=0V, T_J=125^\circ\text{C}$	---	---	-10	μA
Gate-Source Leakage Current	I_{GSS}	$V_{GS}=\pm 10V, V_{DS}=0V$	---	---	± 100	nA
On Characteristics						
Static Drain-Source On-Resistance	$R_{DS(ON)}$	$V_{GS}=-10V, I_D=-4A$	---	32	40	$m\Omega$
		$V_{GS}=-4.5V, I_D=-2A$	---	45	60	$m\Omega$
Gate Threshold Voltage	$V_{GS(th)}$	$V_{GS}=V_{DS}, I_D=-250\mu A$	-1	-1.6	-2.5	V
$V_{GS(th)}$ Temperature Coefficient	$\Delta V_{GS(th)}$		---	3	---	$mV/^\circ\text{C}$
Forward Transconductance	g_{fs}	$V_{DS}=-10V, I_D=-3A$	---	5	---	S
Dynamic and Switching Characteristics						
Total Gate Charge ^{2, 3}	Q_g	$V_{DS}=-20V, V_{GS}=-4.5V, I_D=-2A$	---	8	16	nC
Gate-Source Charge ^{2, 3}	Q_{gs}		---	2.1	4.2	
Gate-Drain Charge ^{2, 3}	Q_{gd}		---	3.6	7.2	
Turn-On Delay Time ^{2, 3}	$T_{d(on)}$	$V_{DD}=-20V, V_{GS}=-4.5V, R_G=25\Omega, I_D=-1A$	---	20	40	nS
Rise Time ^{2, 3}	T_r		---	12	24	
Turn-Off Delay Time ^{2, 3}	$T_{d(off)}$		---	46	80	
Fall Time ^{2, 3}	T_f		---	6	12	
Input Capacitance	C_{iss}	$V_{DS}=-15V, V_{GS}=0V, F=1\text{MHz}$	---	1050	1600	pF
Output Capacitance	C_{oss}		---	110	160	
Reverse Transfer Capacitance	C_{rss}		---	80	120	
Drain-Source Diode Characteristics and Maximum Ratings						
Continuous Source Current	I_S	$V_G=V_D=0V$, Force Current	---	---	-7.2	A
Pulsed Source Current	I_{SM}		---	---	-14.4	A
Diode Forward Voltage	V_{SD}	$V_{GS}=0V, I_S=-1A, T_J=25^\circ\text{C}$	---	---	-1	V

Note:

4. Repetitive Rating: Pulsed width limited by maximum junction temperature.
5. The data tested by pulsed, pulse width $\leq 300 \mu\text{s}$, duty cycle $\leq 2\%$.
6. Essentially independent of operating temperature.

N-Channel Typical Electrical and Thermal Characteristic Curves

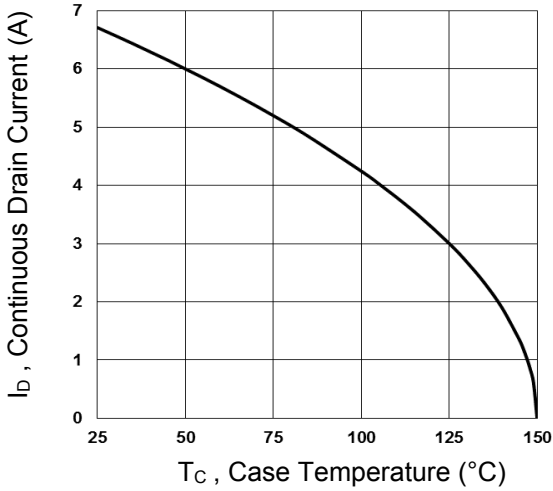

Fig.1 Continuous Drain Current vs. T_C

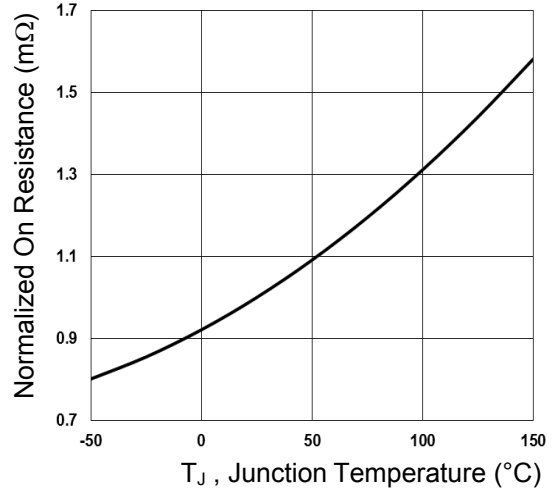

Fig.2 Normalized $R_{DS(ON)}$ vs. T_J

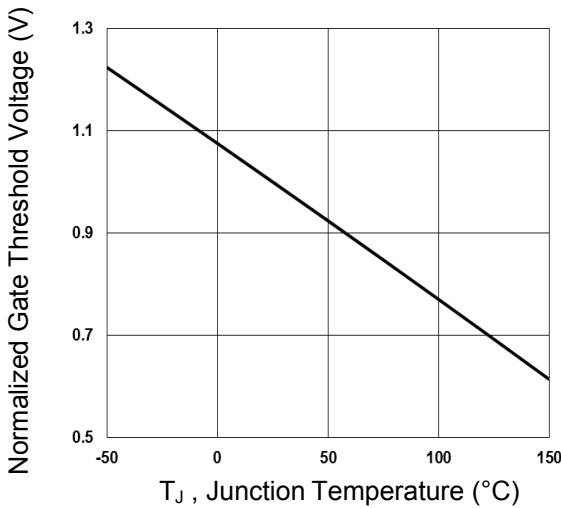

Fig.3 Normalized V_{th} vs. T_J

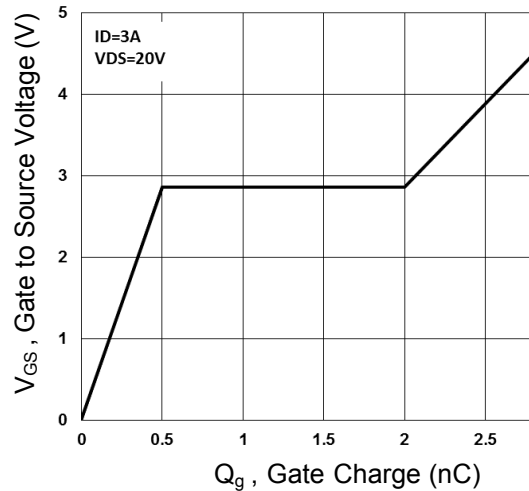

Fig.4 Gate Charge Waveform

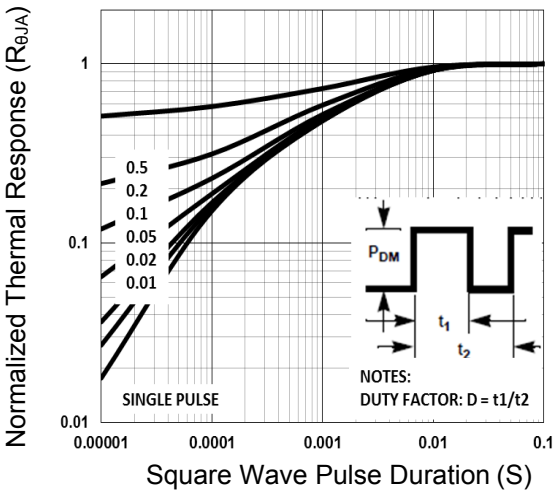

Fig.5 Normalized Transient Impedance

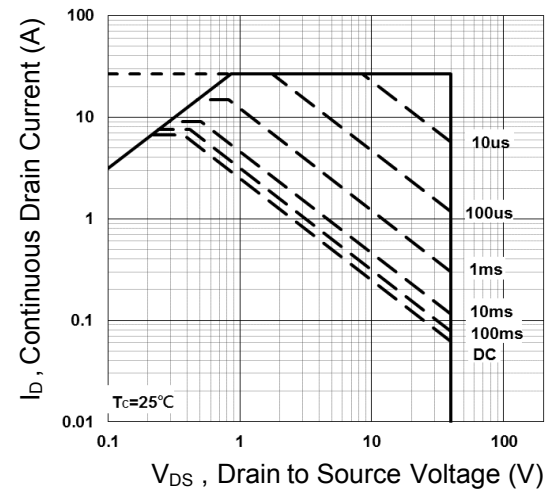

Fig.6 Maximum Safe Operation Area

P-Channel Typical Electrical and Thermal Characteristic Curves

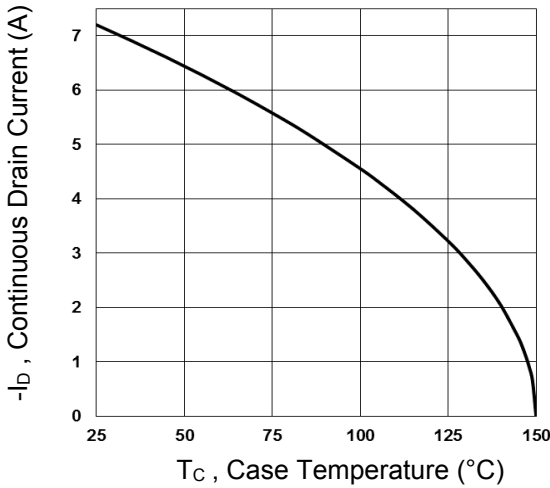

Fig.7 Continuous Drain Current vs. T_c

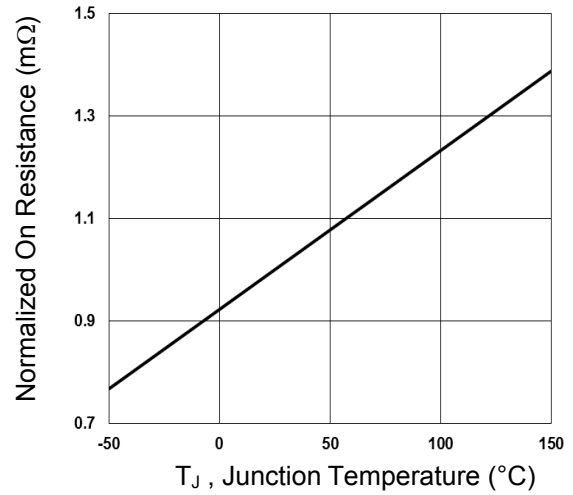

Fig.8 Normalized $R_{DS(ON)}$ vs. T_j

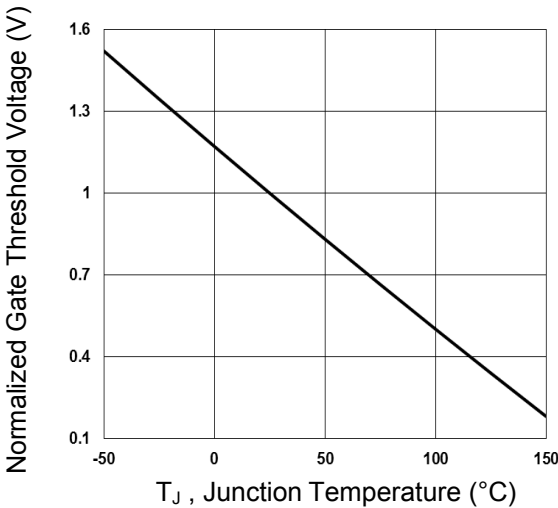

Fig.9 Normalized V_{th} vs. T_j

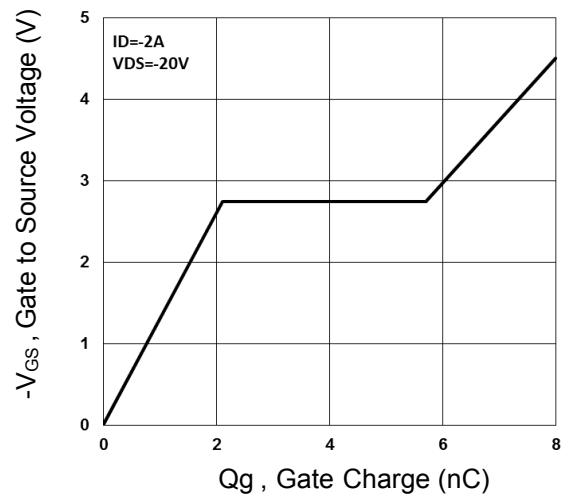

Fig.10 Gate Charge Waveform

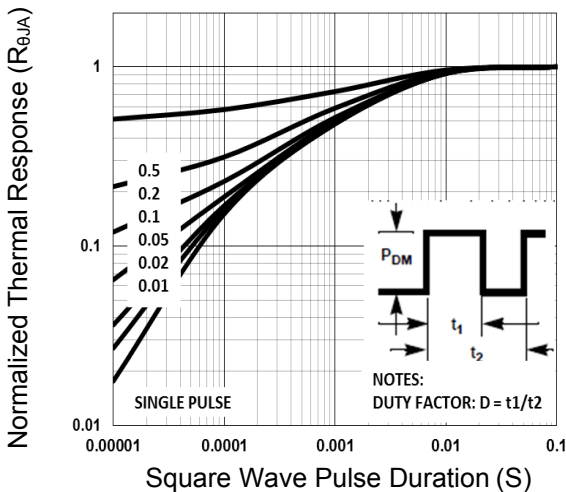

Fig.11 Normalized Transient Impedance

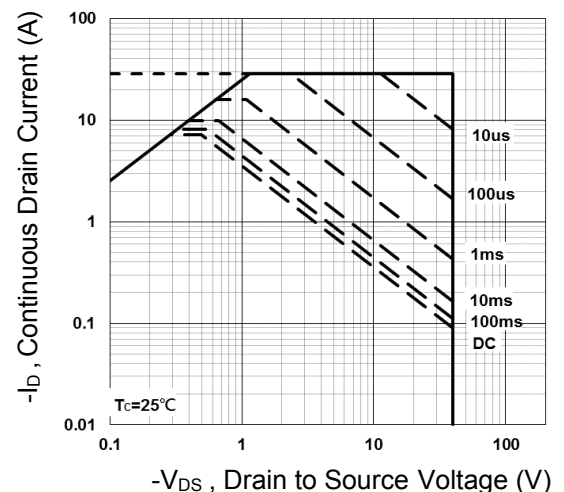
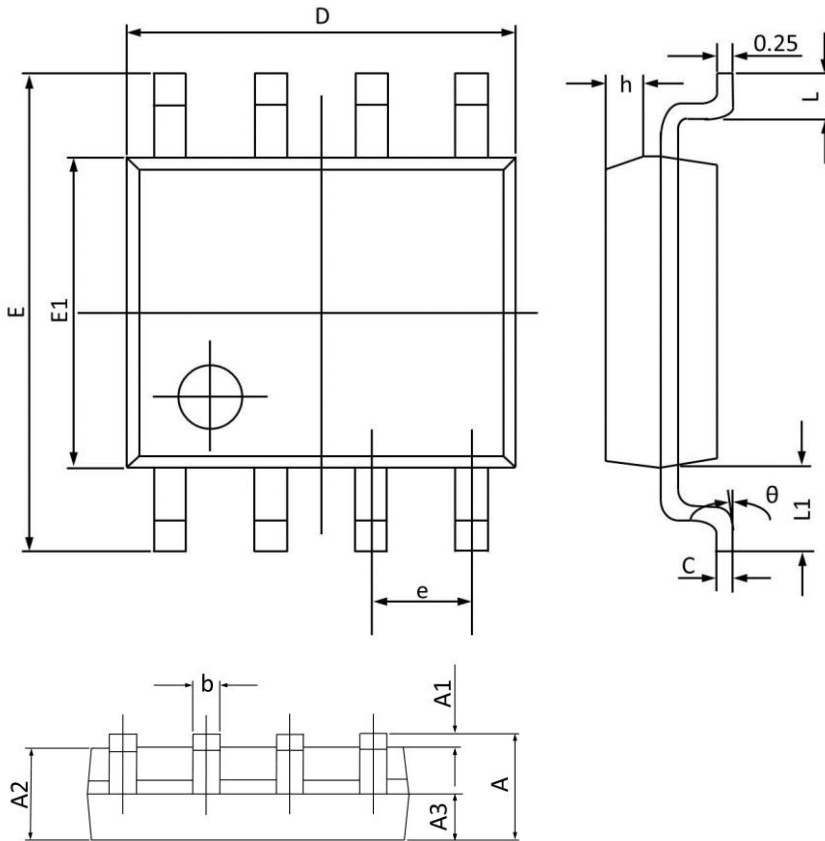

Fig.12 Maximum Safe Operation Area

Package Outline Dimensions

SOP-8



Symbol	Dimensions In Millimeters		Dimensions In Inches	
	Min	Max	Min	Max
A	1.350	1.750	0.053	0.068
A1	0.100	0.250	0.004	0.009
A2	1.300	1.500	0.052	0.059
A3	0.600	0.700	0.024	0.027
b	0.390	0.480	0.016	0.018
c	0.210	0.260	0.009	0.010
D	4.700	5.100	0.186	0.200
E	5.800	6.200	0.229	0.244
E1	3.700	4.100	0.146	0.161
e	1.270(BSC)		0.050(BSC)	
h	0.250	0.500	0.010	0.019
L	0.500	0.800	0.019	0.031
L1	1.050(BSC)		0.041(BSC)	
θ	0°	8°	0°	8°