

Main Product Characteristics

BV_{DSS}	30V
$R_{DS(ON)}$	6.5m Ω @10V (Typ)
	8.4m Ω @4.5V (Typ)
I_D	60A

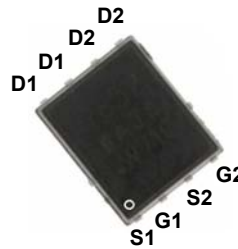

PPAK5x6

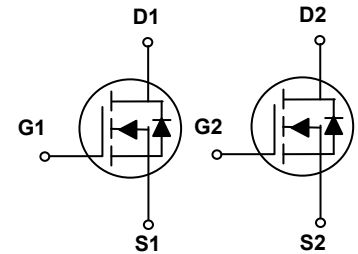

Schematic Diagram

Features and Benefits

- Advanced MOSFET process technology
- Ideal for high efficiency switched mode power supplies
- Low on-resistance with low gate charge
- Fast switching and reverse body recovery



Description

The GSFP03602 utilizes the latest techniques to achieve high cell density and low on-resistance. These features make this device extremely efficient and reliable for use in high efficiency switch mode power supplies and a wide variety of other applications.

Absolute Maximum Ratings ($T_J=25^\circ\text{C}$ unless otherwise specified)

Parameter	Symbol	Max.	Unit
Drain-Source Voltage	V_{DS}	30	V
Gate-Source Voltage	V_{GS}	± 20	V
Drain Current-Continuous ($T_C=25^\circ\text{C}$)	I_D	60	A
Drain Current-Continuous ($T_C=70^\circ\text{C}$)		48	
Drain Current-Pulsed ($T_C=25^\circ\text{C}$) ¹	I_{DM}	240	A
Diode Continuous Forward Current ($T_C=25^\circ\text{C}$)	I_S	60	A
Power Dissipation ($T_C=25^\circ\text{C}$)	P_D	52	W
Avalanche Energy, Single Pulsed ²	E_{AS}	109	mJ
Thermal Resistance, Junction-to-Case	$R_{\theta JC}$	2.4	$^\circ\text{C/W}$
Operating Junction Temperature Range	T_J	-50 To +150	$^\circ\text{C}$
Storage Temperature Range	T_{STG}	-50 To +150	$^\circ\text{C}$

Electrical Characteristics ($T_J=25^\circ\text{C}$ unless otherwise specified)

Parameter	Symbol	Conditions	Min.	Typ.	Max.	Unit
Off Characteristics						
Drain-Source Breakdown Voltage	$V_{(BR)DSS}$	$V_{GS}=0V, I_D=250\mu A$	30	-	-	V
Zero Gate Voltage Drain Current, $T_C=25^\circ\text{C}$	I_{DSS}	$V_{DS}=30V, V_{GS}=0V$	-	-	1	μA
Zero Gate Voltage Drain Current, $T_C=125^\circ\text{C}$		$V_{DS}=24V, V_{GS}=0V$	-	-	100	μA
Gate-Source Leakage Current	I_{GSS}	$V_{GS}=\pm 20V, V_{DS}=0V$	-	-	± 100	nA
On Characteristics						
Gate Threshold Voltage	$V_{GS(th)}$	$V_{GS}=V_{DS}, I_D=250\mu A$	1.0	1.6	2.5	V
Drain-Source On-State Resistance ³	$R_{DS(ON)}$	$V_{GS}=10V, I_D=10A$	-	6.5	8.0	m Ω
		$V_{GS}=4.5V, I_D=8A$	-	8.4	11	m Ω
Dynamic and Switching Characteristics						
Total Gate Charge	Q_g	$V_{DS}=15V,$ $V_{GS}=10V,$ $I_D=30A$	-	23.5	-	nC
Gate-Source Charge	Q_{gs}		-	3.3	-	
Gate-Drain Charge	Q_{gd}		-	4.8	-	
Turn-On Delay Time	$T_{d(on)}$	$V_{DD}=15V,$ $V_{GS}=10V,$ $R_G=3.3\Omega, I_D=15A$	-	11	-	nS
Rise Time	T_r		-	30	-	
Turn-Off Delay Time	$T_{d(off)}$		-	24	-	
Fall Time	T_f		-	6	-	
Input Capacitance	C_{iss}	$V_{DS}=15V, V_{GS}=0V,$ $F=1\text{MHz}$	-	1335	-	pF
Output Capacitance	C_{oss}		-	210	-	
Reverse Transfer Capacitance	C_{rss}		-	140	-	
Gate Resistance	R_g	$F=1\text{MHz}$	-	11	-	Ω
Drain-Source Diode Characteristics and Maximum Ratings						
Diode Forward Voltage ³	V_{SD}	$V_{GS}=0V, I_{SD}=10A$	-	0.83	1.2	V
Reverse Recovery Time	t_{rr}	$I_{SD}=30A, V_{GS}=0V$ $di/dt=100A/\mu s$	-	35	-	nS
Reverse Recovery Charge	Q_{rr}		-	21	-	nC

Note:

1. Repetitive rating: Pulsed width limited by maximum junction temperature.
2. $V_{GS}=10V, L=0.3\text{mH}, I_{AS}=27A, R_G=25\Omega,$ starting $T_J=25^\circ\text{C}$.
3. Pulse test: pulse width $\leq 300\mu s,$ duty cycle $\leq 2\%$.

Typical Electrical and Thermal Characteristic Curves

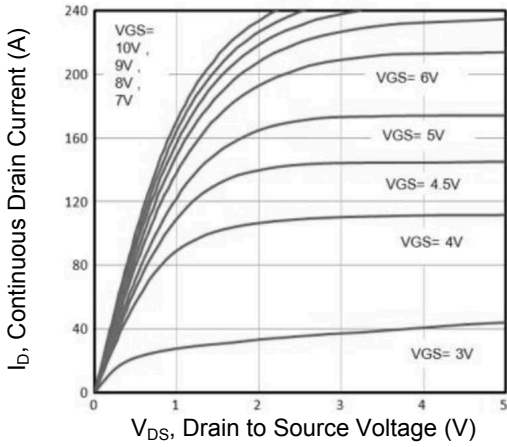

Figure 1. Typical Output Characteristics

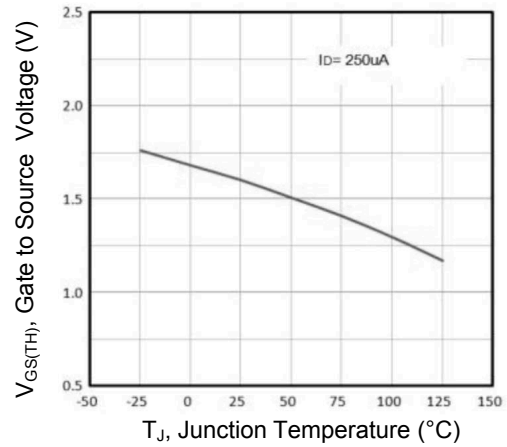

Figure 2. Normalized V_{th} vs. T_J

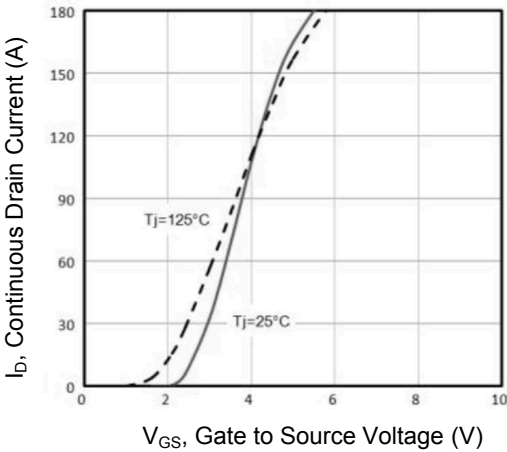

Figure 3. Typical Transfer Characteristics

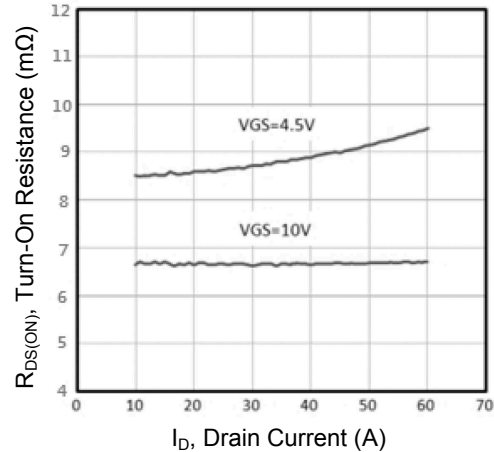

Figure 4. Turn-On Resistance vs. I_D

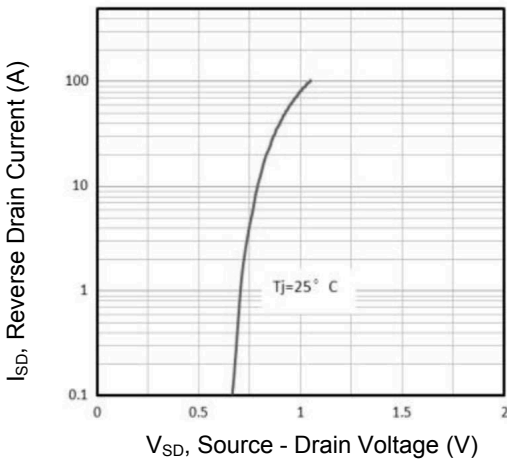

Figure 5. Typical Source - Drain Diode Forward Voltage

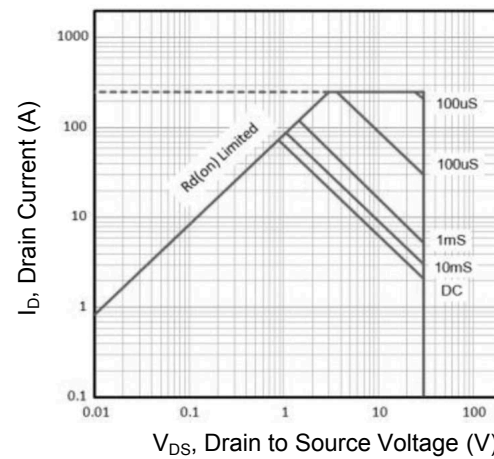

Figure 6. Maximum Safe Operating Area

Typical Electrical and Thermal Characteristic Curves

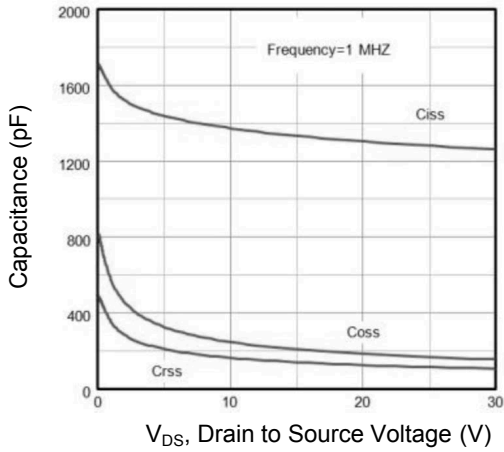

Figure 7. Capacitance Characteristics

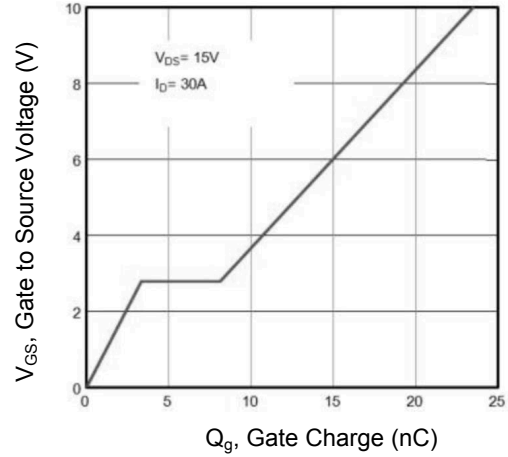

Figure 8. Gate Charge Characteristics

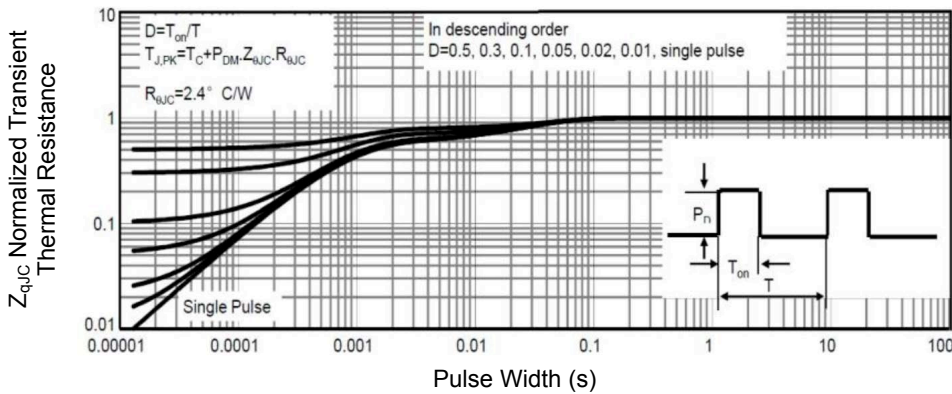

Figure 9. Normalized Maximum Transient Thermal Impedance

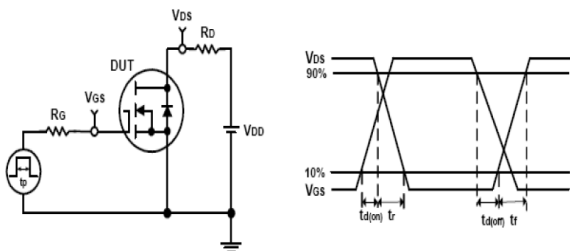

Figure 10. Switching Time Test Circuit and Waveforms

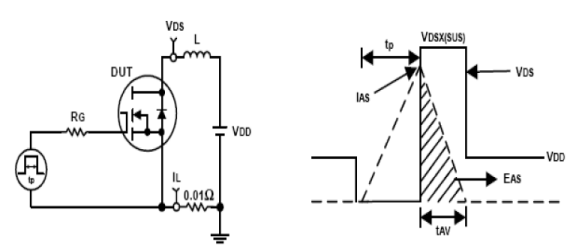
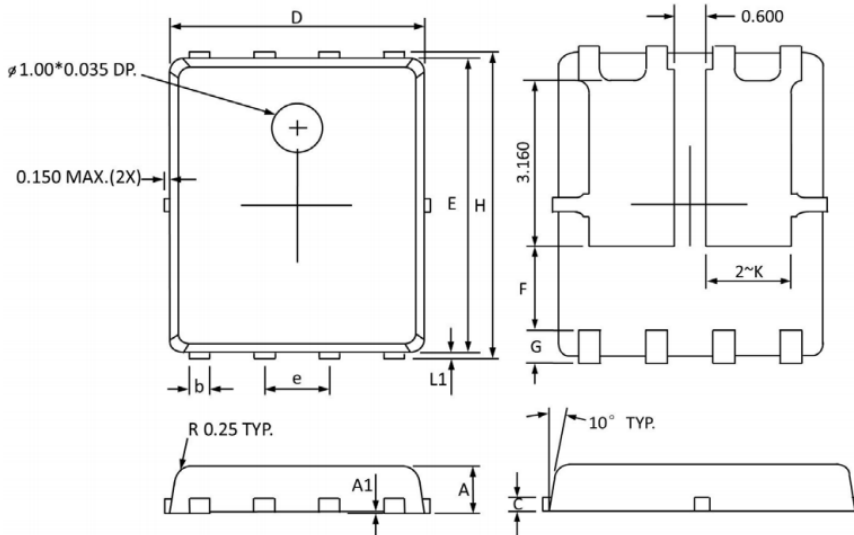

Figure 11. Unclamped Inductive Test Circuit and Waveforms

Package Outline Dimensions (PPAK5x6)



Symbol	Dimensions in Millimeters			Symbol	Dimensions in Millimeters		
	Min	Typ	Max		Min	Typ	Max
A	0.80	0.90	1.05	A1	0.00	-	0.005
b	0.35	0.42	0.49	C	-	0.254 REF	-
D	4.90	5.00	5.10	E	5.70	5.80	5.90
e	-	1.27 BSC	-	F	-	1.60 REF	-
G	-	0.60 REF	-	H	5.95	6.12	6.20
L1	0.10	0.14	0.18	K	-	1.60 REF	-

Order Information

Device	Package	Marking	Carrier	Quantity
GSFP03602	PPAK5x6	007M03	Tape & Reel	5,000 pcs / Reel