

Features

- General-purpose transistor
- For switching and AF amplifier application
- Ultra small package



SOT-883

Applications

- General purpose switching and amplification

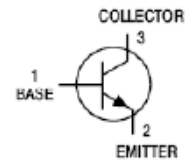

Schematic Diagram

Absolute Maximum Ratings

($T_A = 25^\circ\text{C}$ unless otherwise noted)

Parameter	Symbol	Max.	Unit
Collector-Base Voltage	V_{CBO}	50	V
Collector-Emitter Voltage	V_{CEO}	45	V
Emitter-Base Voltage	V_{EBO}	6	V
Collector Current -Continuous	I_C	0.1	A
Peak Collector Current ($t_p \leq 1\text{ms}$)	I_{CM}	200	mA
Peak Base Current ($t_p \leq 1\text{ms}$)	I_{BM}	100	mA
Collector Dissipation	P_C^1	250	mW
Thermal Resistance Junction to Ambient	$R_{\theta JA}$	500	$^\circ\text{C/W}$
Junction Temperature Range	T_J	-65 To +150	$^\circ\text{C}$
Storage Temperature Range	T_{STG}	-65 To +150	$^\circ\text{C}$

Note 1. Device mounted on an FR4 PCB with 60 μm copper strip line, standard footprint.

Electrical Characteristics ($T_A = 25^\circ\text{C}$ unless otherwise noted)

Parameter	Symbol	Conditions	Min.	Typ.	Max.	Unit
Collector-Base Breakdown Voltage	$V_{(BR)CBO}$	$I_C=10\mu\text{A}, I_E=0$	50	-	-	V
Collector-Emitter Breakdown Voltage	$V_{(BR)CEO}$	$I_C=10\text{mA}, I_B=0$	45	-	-	V
Emitter-Base Breakdown Voltage	$V_{(BR)EBO}$	$I_E=1\mu\text{A}, I_C=0$	6	-	-	V
Collector Cut-Off Current	I_{CBO}	$V_{CB}=30\text{V}, I_E=0$ $T_J=25^\circ\text{C}$	-	-	15	nA
		$V_{CB}=30\text{V}, I_E=0$ $T_J=150^\circ\text{C}$	-	-	5	μA
Emitter-Base Cut-Off Current	I_{EBO}	$V_{EB}=5\text{V}, I_C=0\text{A}$	-	-	100	nA
DC Current Gain	h_{FE}	$V_{CE}=5\text{V}, I_C=10\mu\text{A}$	-	280	-	-
		$V_{CE}=5\text{V}, I_C=2\text{mA}$	200	290	450	-
Collector-Emitter Saturation Voltage ²	$V_{CE(sat)}$	$I_C=10\text{mA}, I_B=0.5\text{mA}$	-	90	200	mV
		$I_C=100\text{mA}, I_B=5\text{mA}$	-	200	400	
Base-Emitter Saturation Voltage ³	$V_{BE(sat)}$	$I_C=10\text{mA}, I_B=0.5\text{mA}$	-	700	-	mV
		$I_C=100\text{mA}, I_B=5\text{mA}$	-	900	-	
Base-Emitter Voltage ³	V_{BE}	$I_C=2\text{mA}, V_{CE}=5\text{V}$	580	660	700	mV
		$I_C=10\text{mA}, V_{CE}=5\text{V}$	-	-	770	
Transition Frequency	f_T	$V_{CE}=5\text{V}, I_C=10\text{mA}, f=100\text{MHz}$	100	-	-	MHz
Collector Capacitance	C_C	$V_{CB}=10\text{V}, f=1\text{MHz}, I_E=i_e=0\text{A}$	-	-	1.5	pF
	C_E	$V_{EB}=0.5\text{V}, f=1\text{MHz}, I_C=i_C=0\text{A}$	-	11	-	pF
Noise Figure	N_F	$V_{CE}=5\text{V}, f=1\text{KHz}$ $R_S=2\text{K}\Omega, BW=200\text{Hz}$ $I_C=200\mu\text{A}$	-	2	10	dB

Notes:

1. Device mounted on an FR4 PCB with 60 μm copper strip line, standard footprint.
2. Pulse test: $t_p \leq 300\mu\text{s}; \delta = 0.02$.
3. V_{BE} decreases by approximately 2 mV/K with increasing temperature

Typical Characteristic Curves

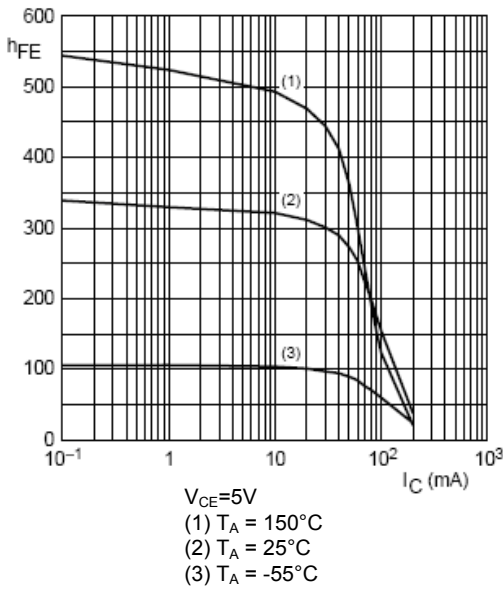

Figure 1. DC Current Gain as a Function of Collector Current, Typical Values

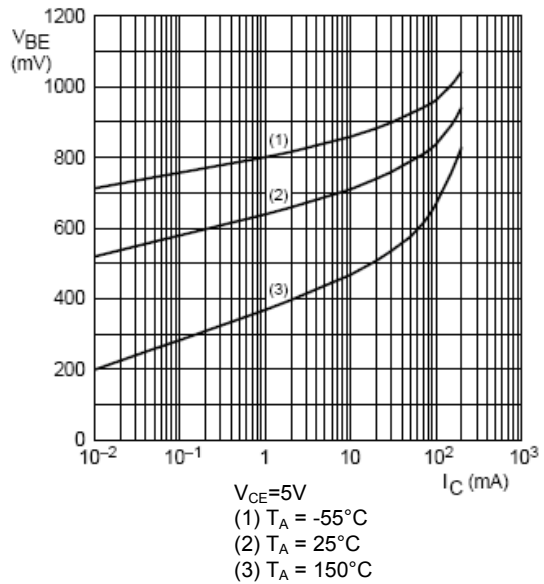

Figure 2. Base-emitter Voltage as a Function of Collector Current, Typical Values

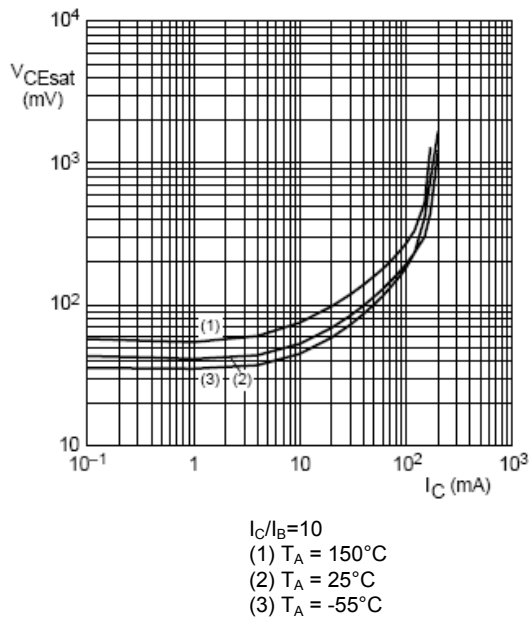

Figure 3. Collector-emitter Saturation Voltage a Function of Collector Current, Typical Values

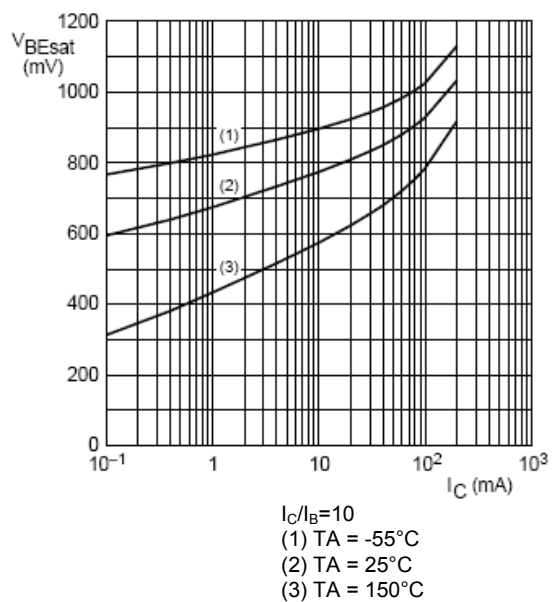
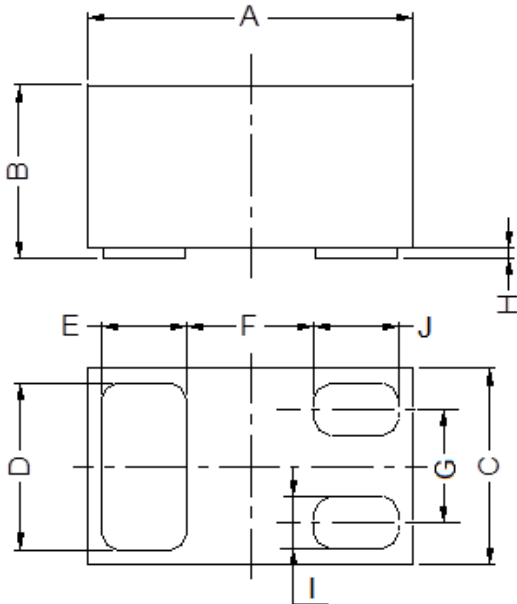

Figure 4. Base-emitter Saturation Voltage a Function of Collector Current, Typical Values

Package Outline Dimensions(SOT-883)



SOT-883			
Dim	Min	Typ	Max
A	0.95	1.00	1.075
B	0.47	0.50	0.53
C	0.55	0.60	0.675
D	0.45	0.50	0.55
E/J	0.20	0.25	0.30
F	-	0.40	-
G	-	0.35	-
H	0	0.03	0.05
I	0.10	0.15	0.20
All Dimensions in mm			

Recommended Pad Layout

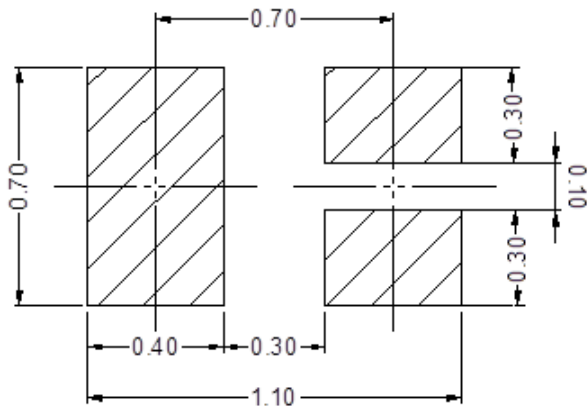

Unit : mm

Ordering Information

Device	Package	Marking	Quantity	HSF Status
GSBC847BM	SOT-883	1F	10,000pcs / Reel	RoHS Compliant